

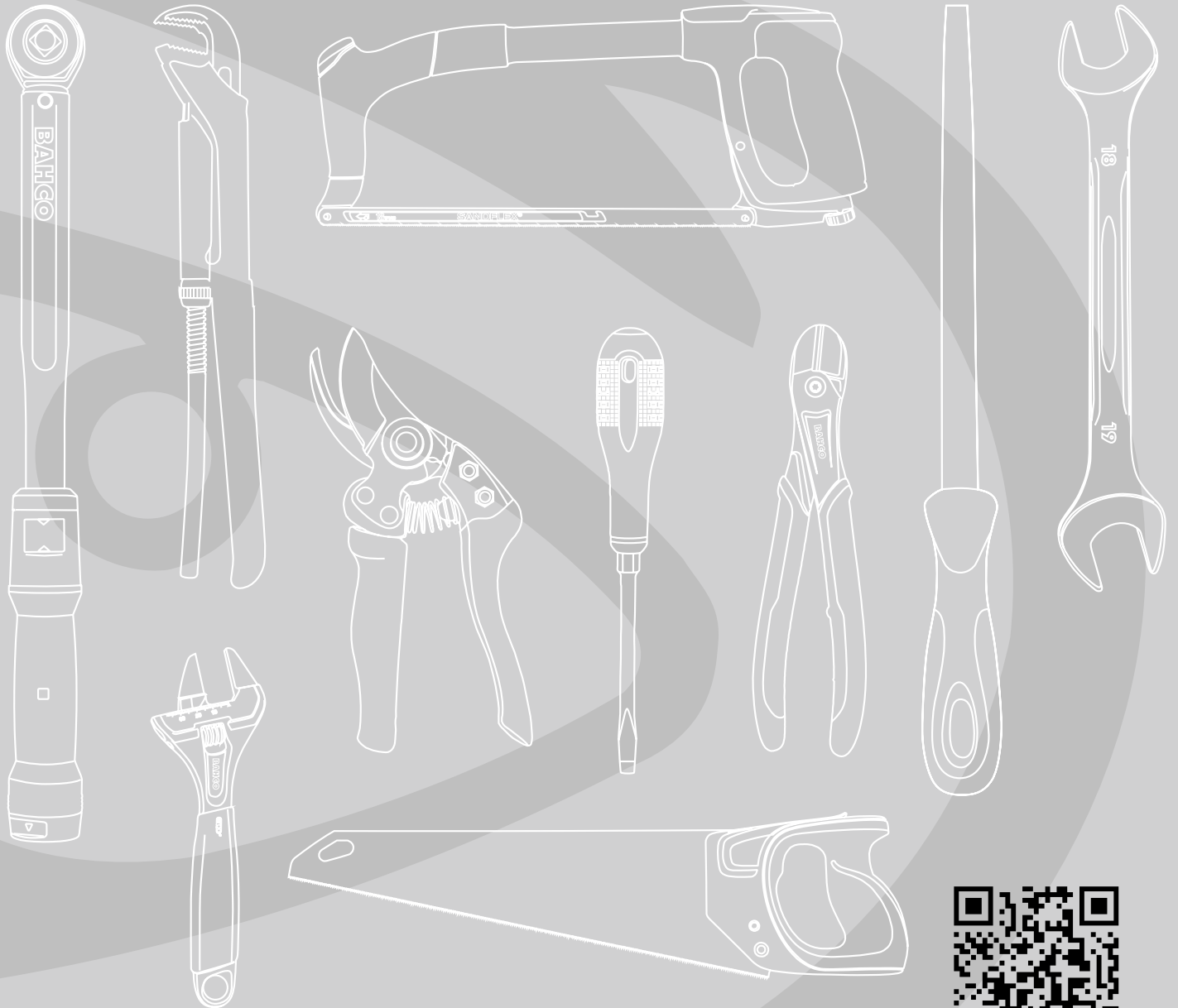

**BAHCO**



[www.bahco.com](http://www.bahco.com)

# Catálogo-Tarifa **2025**





# Catálogo-Tarifa 2025

## Catálogo

---

<b>Contenido</b>	<b>2-9</b>
<b>Capítulos</b>	
Sierras de cinta y otras sierras para máquinas	11-22
Limas	23-38
Llaves	39-62
Llaves de vaso y carracas	63-108
Herramientas dinamométricas	109-128
Accesorios para herramientas eléctricas	129-192
Destornilladores	193-226
Llaves Allen	227-234
Alicates	235-268
Llaves para tubos y herramientas para fontanería	269-276
Herramientas neumáticas	277-290
Herramientas para automoción	291-350
Equipos de iluminación	351-352
Herramientas de inspección	353-356
Extractores	357-366
Almacenamiento de herramientas y composiciones	367-456
Herramientas para trabajos en altura	457-478
Herramientas aisladas	479-492
Herramientas antichispa	493-512
Herramientas de acero inoxidable	513-518
Pinzas y herramientas especiales para electrónica	519-524
Medición y trazado	525-534
Herramientas para pared	535-542
Arcos de sierra manuales	543-546
Serruchos	547-556
Formones	557-562
Tijeras y cuchillos	563-572
Mordazas y tornillos de banco	573-576
Martillos	577-584
Herramientas forestales y de tala de árboles	585-588
Cinceles y punteros de chapista	589-596
Palanca desencofrar	597-600
Herramientas para plantación y cultivo	601-604
Herramientas de poda	605-622
Herramientas neumáticas de exterior	623-626
Lindstrom	627-648
<b>Índice alfanumérico</b>	<b>649-729</b>
<b>Precio de la soldadura</b>	<b>730</b>
<b>Condiciones generales de Venta</b>	<b>731</b>
<b>Garantía</b>	<b>735</b>

---

**11-22 SIERRAS DE CINTA Y OTRAS SIERRAS PARA MÁQUINAS**

**23-38 LIMAS**



**39-62 LLAVES**



**63-108 LLAVES DE VASO Y CARRACAS**



**109-128 HERRAMIENTAS DINAMOMÉTRICAS**



**129-192 ACCESORIOS PARA HERRAMIENTAS ELÉCTRICAS**



193-226 DESTORNILLADORES



227-234 LLAVES ALLEN



235-268 ALICATES



269-276 LLAVES PARA TUBOS Y HERRAMIENTAS PARA FONTANERÍA



277-290 HERRAMIENTAS NEUMÁTICAS







457-478 HERRAMIENTAS PARA TRABAJOS EN ALTURA



479-492 HERRAMIENTAS AISLADAS



493-512 HERRAMIENTAS ANTICHISPA



513-518 HERRAMIENTAS DE ACERO INOXIDABLE



519-524 PINZAS Y HERRAMIENTAS ESPECIALES PARA ELECTRÓNICA

525-534 MEDICIÓN Y TRAZADO



535-542 HERRAMIENTAS PARA PARED



543-546 ARCOS DE SIERRA MANUALES

547-556 SERRUCHOS



557-562 FORMONES



563-572 TIJERAS Y CUCHILLOS



573-576 MORDAZAS Y TORNILLOS DE BANCO



577-584 MARTILLOS



585-588 HERRAMIENTAS FORESTALES Y DE TALA DE ÁRBOLES



589-596 CINCELES Y PUNTEROS DE CHAPISTA



597-600 PALANCA DESENCOFRAR



601-604 HERRAMIENTAS PARA PLANTACIÓN Y CULTIVO



605-622 HERRAMIENTAS DE PODA



623-626 HERRAMIENTAS NEUMÁTICAS DE EXTERIOR



627-648 LINDSTRÖM



# Contenido

<b>Sierras de cinta y otras sierras para máquinas</b>	<b>11-22</b>	<b>Destornilladores</b>	<b>193-226</b>
SIERRAS DE CINTA BIMETÁLICAS PARA EL CORTE DE METAL	12	DESTORNILLADORES ERGO™ CON MANGO TRI-COMPONENTE	194
SIERRAS DE CINTA TRIMETÁLICAS PARA EL CORTE DE METAL	15	DESTORNILLADORES ERGO™ CON MANGO DE IMPACTO	204
SIERRAS DE CINTA DE METAL DURO PARA METAL	15	DESTORNILLADORES BAHCOFIT CON MANGO BI-MATERIAL	206
HOJA DE SIERRA PARA MADERA	17	DESTORNILLADORES CON MANGO DE GOMA	214
SIERRAS DE CINTA PARA CORTE DE AISLAMIENTO	18	DESTORNILLADORES CON MANGO DE CARRACA	217
SIERRAS CIRCULARES DE ACERO RÁPIDO	18	DESTORNILLADORES CON MANGO DE PRECISIÓN	219
HOJAS DE SIERRA DE MÁQUINA	19	DESTORNILLADORES CON MANGO EN T	222
ACCESORIOS PARA SIERRAS DE CINTA	21	DESTORNILLADORES PORTAPUNTAS DE 1/4"	223
		DESTORNILLADORES CON MANGO DE MADERA O PLÁSTICO	223
<b>Limas</b>	<b>23-38</b>	COMPROBADORES ELÉCTRICOS	225
LIMAS DE MECÁNICO	24	IMANTADOR DESTORNILLADORES	226
LIMAS PARA AFILADO	28		
ESCOFINAS	32	<b>Llaves Allen</b>	<b>227-234</b>
LIMAS CON DIENTES FRESADOS	33	CON PUNTA HEXAGONAL	228
LIMAS DE AGUJA	33	CON PUNTA TORX®	232
LIMAS DE DIAMANTE	36	LLAVES ALLEN DE DOS BOCAS	234
ACCESORIOS	37	MULTIHERRAMIENTAS	234
<b>Llaves</b>	<b>39-62</b>	<b>Alicates</b>	<b>235-268</b>
LLAVES AJUSTABLES "INGLESAS"	40	ALICATES DE CORTE	236
LLAVES COMBINADAS	42	ALICATES UNIVERSALES	243
LLAVES DE CARRACA	47	ALICATES DE MANIPULACIÓN	244
LLAVES FIJAS DE DOS BOCAS	50	TENACILLAS ARTICULADAS	250
LLAVES DE ESTRELLA DE DOS BOCAS	54	ALICATES PARA ARANDELAS	252
LLAVES PARA RACORES	56	PELACABLES Y HERRAMIENTAS PARA DESMONTAJE	255
LLAVES DE GOLPEO	57	ALICATES PARA TERMINALES	258
LLAVES DE TUBO	58	JUEGOS DE ALICATES	261
LLAVES UNIVERSALES	61	MORDAZAS DE PRESION	262
LLAVES DE GANCHO ARTICULADAS	62	REMACHADORAS	266
		ALICATES ESPECIALES	267
<b>Llaves de vaso y carracas</b>	<b>63-108</b>	<b>Llaves para tubos y herramientas para fontanería</b>	<b>269-276</b>
JUEGOS DE VASOS	64	LLAVES PARA TUBOS	270
1/4"	81	HERRAMIENTAS DE CORTATUBOS	271
3/8"	88	HERRAMIENTAS DE DOBLADO Y CONFORMADO	274
1/2"	95	HERRAMIENTAS DE REBABADO	274
3/4"	103		
1"	106	<b>Herramientas neumáticas</b>	<b>277-290</b>
CAJAS VACÍAS PARA JUEGOS DE VASOS	107	PISTOLAS DE IMPACTO NEUMÁTICAS	278
LLAVES DE CARRACA PARA ESTRUCTURAS	107	CARRACAS NEUMÁTICAS	280
		AMOLADORAS, LIJADORAS Y PULIDORAS NEUMÁTICAS	281
<b>Herramientas dinamométricas</b>	<b>109-128</b>	TALADRO NEUMÁTICO	285
LLAVES DINAMOMÉTRICAS DIGITALES	110	HERRAMIENTAS DE CORTE	286
LLAVES DINAMOMÉTRICAS MECÁNICAS	112	MARTILLOS, REMACHADORAS Y MARCADORES	287
DESTORNILLADORES DINAMOMÉTRICOS	117	PISTOLAS DE PINTAR	288
MULTIPLICADORES	119	HERRAMIENTAS DE SOPLADO Y LIMPIEZA	288
COMPROBADORES DE PAR	120	EQUIPAMIENTO Y ACCESORIOS PARA HERRAMIENTAS NEUMÁTICAS	289
ADAPTADORES DE PAR Y ÁNGULO	121		
HERRAMIENTAS DE INSERCIÓN	121	<b>Herramientas para automoción</b>	<b>291-350</b>
JUEGOS DE MALETAS VACÍAS PARA HERRAMIENTAS DINAMOMÉTRICAS	127	HERRAMIENTAS PARA MOTOR	292
		HERRAMIENTAS PARA SISTEMAS DE ESCAPE	314
<b>Accesorios para herramientas eléctricas</b>	<b>129-192</b>	HERRAMIENTAS Y EQUIPAMIENTOS PARA CAMBIOS DE ACEITE	315
CORONAS DE SIERRA	130	HERRAMIENTAS Y EQUIPOS PARA SISTEMAS DE FRENADO	319
HOJAS DE SABLE	140	HERRAMIENTAS PARA RUEDAS Y TRANSMISIÓN	323
HOJAS DE CALAR	144	HERRAMIENTAS Y EQUIPOS PARA SUSPENSIÓN	331
ACCESORIOS MULTIHERRAMIENTAS	144	HERRAMIENTAS PARA BATERÍAS Y SISTEMAS ELÉCTRICOS	331
HOJAS PARA SIERRAS CIRCULARES	147	PRENSAS Y ACCESORIOS	336
DISCOS ABRASIVOS	148	EQUIPAMIENTO LIGERO	337
SIERRAS DE CINTA	149	HERRAMIENTAS PARA CARROCERÍA	339
LIMAS ROTATIVAS DE CARBURO	149	EQUIPOS DE ELEVACIÓN	344
BROCAS	154		
PUNTAS DESTORNILLADOR	162		
VASOS DE IMPACTO	179		



<b>Equipos de iluminación</b>	<b>351-352</b>	<b>Herramientas de acero inoxidable</b>	<b>513-518</b>
LINTERNAS MANUALES	352	CARROS	514
LINTERNAS PARA LA CABEZA	352	LLAVES ACERO INOXIDABLE	514
ENROLLADORES DE CABLE	352	LLAVES DE VASO Y CARRACAS ACERO INOXIDABLE	515
		DESTORNILLADORES DE ACERO INOXIDABLE	516
		LLAVES ALLEN DE ACERO INOXIDABLE	517
		PUNTAS ACERO INOXIDABLE	517
		ALICATES ACERO INOXIDABLE	518
		MARTILLOS DE ACERO INOXIDABLE	518
		CINCELES Y PUNTEROS DE CHAPISTA	518
<b>Herramientas de inspección</b>	<b>353-356</b>		
ENDOSCOPIOS	354		
ESTETOSCOPIOS	354		
ESPEJOS	354		
LUPAS	355		
<b>Extractores</b>	<b>357-366</b>	<b>Pinzas y herramientas especiales para electrónica</b>	<b>519-524</b>
MECÁNICO	358	PINZAS ELECTRONICA	520
PALANCAS	364	HERRAMIENTAS DE SOLDADURA	522
HERRAMIENTAS PARA RECOGIDA	365	HERRAMIENTAS PARA MECÁNICA DE PRECISIÓN	523
HERRAMIENTAS PARA ROSCAS	365		
<b>Almacenamiento de herramientas y composiciones</b>	<b>367-456</b>	<b>Medición y trazado</b>	<b>525-534</b>
CARROS DE HERRAMIENTAS	368	FLEXÓMETROS Y CINTAS MÉTRICAS	526
MALETAS RÍGIDAS	425	RUEDAS DE MEDICIÓN	527
ARMARIOS Y PANELES	435	NIVELES	527
CAJAS DE HERRAMIENTAS METÁLICAS	441	MARCADO	530
CAJAS Y ESTUCHES DE PLÁSTICO	449	REGLAS	531
EQUIPOS TEXTILES Y DE PIEL	450	ESCUADRAS	532
		MEDICIÓN DE PRECISIÓN	533
<b>Herramientas para trabajos en altura</b>	<b>457-478</b>	<b>Herramientas para pared</b>	<b>535-542</b>
ALMACENAMIENTO DE HERRAMIENTAS Y CORDONES	458	RASCADORES	536
LLAVES PARA TRABAJOS EN ALTURA	460	HERRAMIENTAS PARA ALBAÑILERÍA	538
LLAVES PARA TUBOS TRABAJOS EN ALTURA	462	HERRAMIENTAS PARA PAREDES DE PLACAS DE ESCAYOLA	540
LLAVES DE VASO Y CARRACAS TRABAJOS EN ALTURA	463		
DESTORNILLADORES PARA TRABAJOS EN ALTURA	467		
ALICATES CON ANILLO DE SEGURIDAD	469		
HERRAMIENTAS DE CORTE	471		
MARTILLOS, PALANCAS Y CINCELES	473		
MEDICIÓN Y TRAZADO	475		
HERRAMIENTAS DINAMOMÉTRICAS	476		
HERRAMIENTAS DE SUJECCIÓN	477		
OTRAS HERRAMIENTAS	477		
GUANTES	478		
<b>Herramientas aisladas</b>	<b>479-492</b>	<b>Arcos de sierra manuales</b>	<b>543-546</b>
DESTORNILLADORES AISLADOS	480	ARCOS DE SIERRA	544
ALICATES AISLADOS	486	HOJAS DE ARCOS DE SIERRA	545
LLAVES AISLADAS	489		
VASOS Y CARRACAS AISLADOS	490		
TIJERAS Y CUCHILLOS AISLADOS	490		
PINZAS AISLADAS	491		
EQUIPOS DE PROTECCIÓN	491		
JUEGOS DE HERRAMIENTAS AISLADAS	491		
<b>Herramientas antichispa</b>	<b>593-512</b>	<b>Serruchos</b>	<b>547-556</b>
LLAVES ANTICHISPA	494	SERRUCHOS PARA MATERIALES DE CONSTRUCCIÓN	548
HERRAMIENTAS PARA FONTANERÍA	499	SERRUCHOS PARA MADERA	549
LLAVES DE VASO Y CARRACAS ANTICHISPA	500	SERRUCHOS DE PRECISIÓN	553
DESTORNILLADORES ANTICHISPA	503	MANGOS Y AFILADORES	554
ALICATES ANTICHISPA	504	HOJAS Y ARCOS DE MARQUETERÍA	554
MARTILLOS, PALANCAS Y CINCELES	506	ARCOS Y HOJAS PARA RECORTE	555
RASQUETAS	509	SERRUCHO "MUSICAL"	555
HERRAMIENTAS DE JARDINERÍA	511		
EXTRACTORES	511		
LLAVES DINAMOMÉTRICAS ANTICHISPA	512		
		<b>Formones</b>	<b>557-562</b>
		FORMONES	558
		CINCELES GUBIA	560
		CINCELES DE DEMOLICIÓN	560
		ACCESORIOS PARA FORMONES	561
		<b>Tijeras y cuchillos</b>	<b>563-572</b>
		TIJERAS CORTACHAPAS	564
		TIJERAS ELECTRICISTA	565
		CUCHILLOS	566
		<b>Mordazas y tornillos de banco</b>	<b>573-576</b>
		MORDAZAS DE BANCO	574
		TORNILLOS DE BANCO	575
		ACCESORIOS PARA TORNILLOS DE BANCO	576



**Martillos 577-584**

MARTILLOS DE CARPINTERO	578
EXTRACTORES DE CLAVOS	579
MARTILLOS DE MECÁNICO	579
MARTILLOS PARA CONSTRUCCIÓN	580
MARTILLOS ESPECIALES	582
MARTILLOS SLEDGE	582
MARTILLOS Y MAZAS BLANDOS	583

**Herramientas forestales y de tala de árboles 585-588**

HACHAS, ALCOTANAS Y MAZAS	586
CUÑAS	587

**Cinceles y punteros de chapista 589-596**

CINCELES DE CHAPISTA	590
CINCELES DE CHAPISTA CON PROTECCIÓN	591
CINCELES DE CHAPISTA (REAFILABLES)	591
CINCELES DE CHAPISTA - ACCESORIOS	592
PUNTEROS	592
PUNTEROS CON MANGO BIMATERIAL	596
CINCELES DE CHAPISTA CON MANGO BIMATERIAL	596

**Palanca desengofrar 597-600**

BARRAS DESENGOFRADORAS	598
------------------------	-----

**Herramientas para plantación y cultivo 601-604**

PEQUEÑAS HERRAMIENTAS DE JARDINERÍA	602
-------------------------------------	-----

**Herramientas de poda 605-622**

TIJERAS DE PODAR DE UNA MANO	606
HERRAMIENTAS PARA RECOGIDA DE FRUTA	610
TIJERAS DE PODAR DE DOS MANOS	611
SERRUCHOS CON PÉRTIGA Y PODADERAS DE ALTURA	613
CORTASETOS	616
TIJERAS CORTACÉPEDES	617
TIJERAS FLORALES	618
ARCOS TRONZADORES	618
SERRUCHOS DE PODA	620
REPUESTOS Y ACCESORIOS	621
ACCESORIOS Y MANTENIMIENTO	622

**Herramientas neumáticas de exterior 623-626**

TIJERAS DE PODA NEUMÁTICAS	624
----------------------------	-----

**Lindström 627-648**

Kits y Sets	
KITS DE JOYERÍA	628

Alicate de precisión	
CABEZA AFILADA	628
CABEZA PUNTIAGUDA	628
CABEZA OBLICUA	628
SETS ALICATES DE PRECISIÓN	628

Destornilladores de Precisión	
ESD	629

Cortantes "heavy duty"	
ALICATES CORTE DIAGONAL	629

**Cortantes de precisión**

ALICATES CORTE DIAGONAL	630
ALICATES CORTE DIAGONAL, CABEZA ESPECIAL	631
ALICATES DE CORTE OBLICUO	631
ÁNGULO	631
CORTADOR PARA PLÁSTICO	632
CORTE CON PUNTA	632
ALICATES DE CORTE OBLICUO, CABEZA ESPECIAL	632
CORTANTES PUNTA MICRO	633
CIZALLAS MULTIUSOS	633
ACCESORIOS Y REPUESTOS	633

**Cortantes de precisión para materiales duros**

CORTANTE DE CARBURO	634
ALICATES CORTE DIAGONAL EXTRA REFORZADO	634
ALICATES CORTE DIAGONAL RENDIMIENTO ESPECÍFICO	634
ALICATES CORTE DIAGONAL RENDIMIENTO ESPECÍFICO, CABEZA ESPECIAL	634

**Alicates de manipulación de precisión**

BOCA PLANA	635
BOCA REDONDA	635
BOCA CADENA	635
ALICATE PARA CREAR CADENAS DE JOYERÍA	635
BOCA DOBLADA	636
BOCA SEMIRREDONDA, CABEZA ESPECIAL	636
BOCA SEMIRREDONDA, CABEZA ESPECIAL	636
BOCA AGUJA	636

**Pelacables**

ALICATES CORTE DIAGONAL	636
-------------------------	-----

**Herramientas dinamométricas**

DESTORNILLADORES DINAMOMÉTRICOS	637
---------------------------------	-----

**Pinzas**

JUEGOS DE PINZAS	637
PINZAS DE CORTE	638
PINZAS DE PRECISIÓN	638
PINZAS DE PLÁSTICO DE PUNTA REEMPLAZABLE - FIBRA DE CARBONO	640
PINZAS TÁCTILES ERGONÓMICAS CON SEGURIDAD ESD	642
PINZAS ECONÓMICAS	643
PINZAS SMD	644
COMPONENTES PINZAS DE POSICIONAMIENTO	646
PINZAS UNIVERSALES	646
REPUESTOS Y ACCESORIOS	646





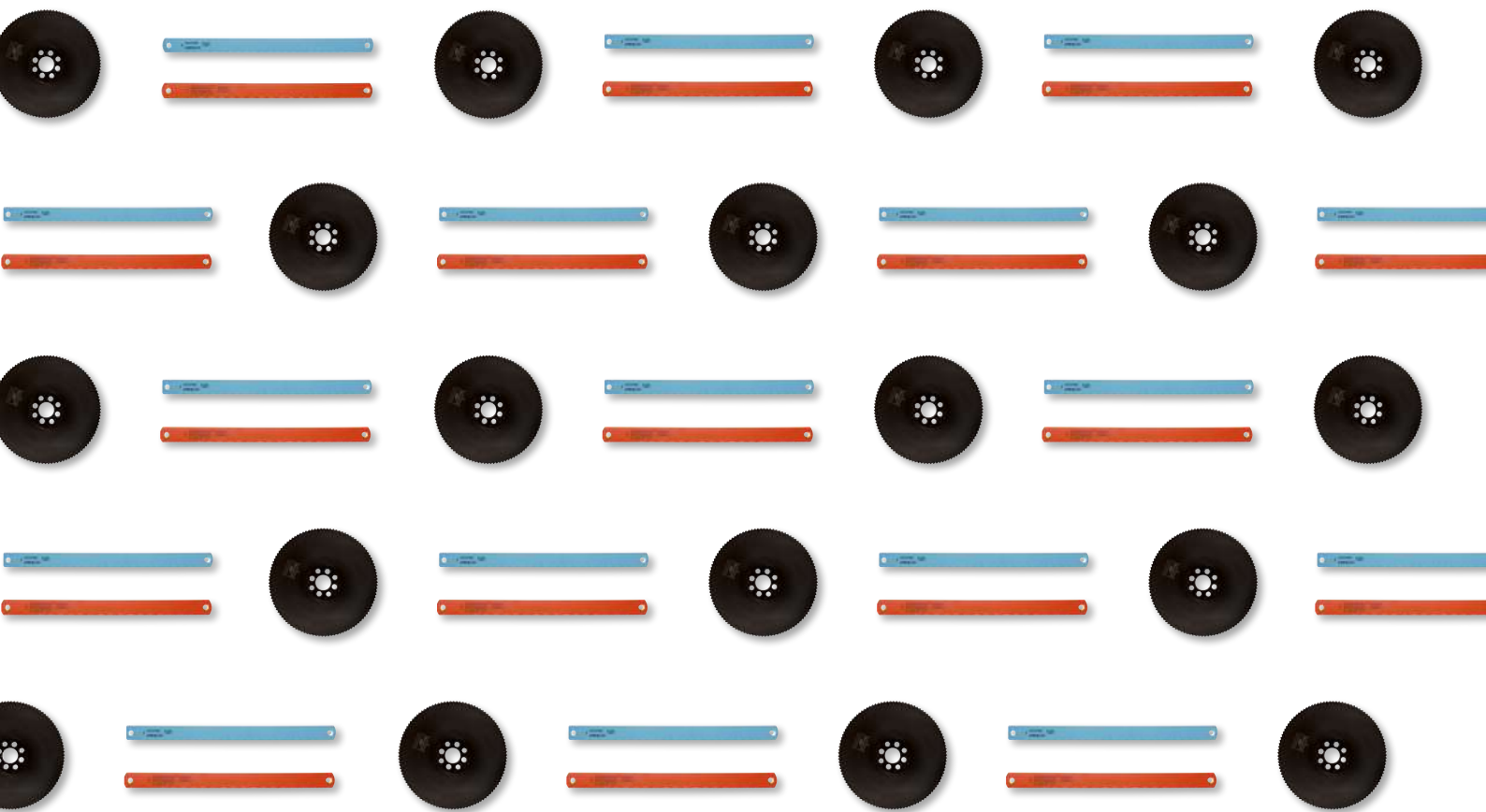

## Sierras de cinta y otras sierras para máquinas



## SIERRAS DE CINTA BIMETÁLICAS PARA EL CORTE DE METAL

Sierra cinta Easy Cut

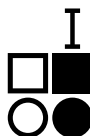

### 3857 Easy-Cut

		€		
13 mm	EZ	10,10	1	3857-13-0.6-EZ-S
13 mm	EZ	10,10	1	3857-13-0.6-EZ-M
13 mm	EZ	10,10	1	3857-13-0.6-EZ-L
20 mm	EZ	11,24	1	3857-20-0.9-EZ-S
20 mm	EZ	11,24	1	3857-20-0.9-EZ-M
20 mm	EZ	11,24	1	3857-20-0.9-EZ-L
27 mm	EZ	12,80	1	3857-27-0.9-EZ-S
27 mm	EZ	12,80	1	3857-27-0.9-EZ-M
27 mm	EZ	12,80	1	3857-27-0.9-EZ-L
34 mm	EZ	15,72	1	3857-34-1.1-EZ-S
34 mm	EZ	15,72	1	3857-34-1.1-EZ-M
34 mm	EZ	15,72	1	3857-34-1.1-EZ-L

Sandflex® Cobra™

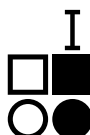

### 3851 Contour and small machine

		€		
6 mm	PRX	8,92	1	3851-6-0.6-10/14
6 mm	Hook	8,92	1	3851-6-0.6-H-6
6 mm	PRX	8,92	1	3851-6-0.9-10/14
6 mm	Hook	8,92	1	3851-6-0.9-H-6
10 mm	PRX	9,25	1	3851-10-0.6-10/14
10 mm	Hook	9,25	1	3851-10-0.6-H-4
10 mm	Hook	9,25	1	3851-10-0.6-H-6
10 mm	PRX	9,25	1	3851-10-0.9-10/14
10 mm	Hook	9,25	1	3851-10-0.9-H-4
10 mm	Hook	9,25	1	3851-10-0.9-H-6
10 mm	Regular	9,25	1	3851-10-0.9-R-14
13 mm	PRX	9,25	1	3851-13-0.5-10/14

		€		
13 mm	PRX	9,25	1	3851-13-0.5-14/18
13 mm	Regular	9,25	1	3851-13-0.5-R-10
13 mm	Regular	9,25	1	3851-13-0.5-R-14
13 mm	Regular	9,25	1	3851-13-0.5-R-18
13 mm	Regular	9,25	1	3851-13-0.5-R-24
13 mm	Hook	9,25	1	3851-13-0.5-H-4
13 mm	PRX	9,25	1	3851-13-0.6-10/14
13 mm	PRX	9,25	1	3851-13-0.6-5/8
13 mm	PRX	9,25	1	3851-13-0.6-6/10
13 mm	PRX	9,25	1	3851-13-0.6-8/12
13 mm	Hook	9,25	1	3851-13-0.6-H-3
13 mm	Hook	9,25	1	3851-13-0.6-H-4
13 mm	Hook	9,25	1	3851-13-0.6-H-6
13 mm	Regular	9,25	1	3851-13-0.6-R-10
13 mm	Regular	9,25	1	3851-13-0.6-R-14
13 mm	Regular	9,25	1	3851-13-0.6-R-18
13 mm	PRX	9,25	1	3851-13-0.9-10/14
13 mm	PRX	9,25	1	3851-13-0.9-6/10
13 mm	Hook	9,25	1	3851-13-0.9-H-3
13 mm	Hook	9,25	1	3851-13-0.9-H-4
13 mm	Hook	9,25	1	3851-13-0.9-H-6
13 mm	Regular	9,25	1	3851-13-0.9-R-14
13 mm	Regular	9,25	1	3851-13-0.9-R-6
20 mm	PRX	9,42	1	3851-20-0.9-10/14
20 mm	Hook	9,42	1	3851-20-0.9-H-3
20 mm	Hook	9,42	1	3851-20-0.9-H-4
20 mm	Regular	9,42	1	3851-20-0.9-R-18
20 mm	PRX	9,42	1	3851-20-0.9-4/6
20 mm	PRX	9,42	1	3851-20-0.9-5/8
20 mm	PRX	9,42	1	3851-20-0.9-6/10
20 mm	PRX	9,42	1	3851-20-0.9-8/12
27 mm	PS	9,58	1	3851-27-0.9-P-3
27 mm	PS	9,58	1	3851-27-0.9-P-4
27 mm	Regular	9,58	1	3851-27-0.9-R-6
34 mm	PS	14,08	1	3851-34-1.1-P-2
34 mm	PS	14,08	1	3851-34-1.1-P-3

Sandflex® Cobra™ Fundición



### 3851 Sandflex® Cobra™ Foundry

		€		
10 mm	HA	9,25	1	3851-10-0.6-HA-4
13 mm	HA	9,25	1	3851-13-0.6-HA-4
13 mm	HA	9,25	1	3851-13-0.6-HA-6
13 mm	HA	9,25	1	3851-13-0.9-HA-4
20 mm	HA	9,42	1	3851-20-0.9-HA-3
20 mm	HA	9,42	1	3851-20-0.9-HA-4
27 mm	HA	9,58	1	3851-27-0.9-HA-4
27 mm	HA	9,58	1	3851-27-0.9-HA-3



**3851 Sandflex® Cobra™**

		€		
27 mm	PRX	9,58	1	3851-27-0.9-2/3
27 mm	PRX	9,58	1	3851-27-0.9-3/4
27 mm	PRX	9,58	1	3851-27-0.9-4/6
27 mm	PRX	9,58	1	3851-27-0.9-5/8
27 mm	PRX	9,58	1	3851-27-0.9-6/10
27 mm	PRX	9,58	1	3851-27-0.9-8/12
27 mm	PRX	9,58	1	3851-27-0.9-10/14
34 mm	PRX	14,08	1	3851-34-1.1-2/3
34 mm	PRX	14,08	1	3851-34-1.1-3/4
34 mm	PRX	14,08	1	3851-34-1.1-4/6
34 mm	PRX	14,08	1	3851-34-1.1-5/8
34 mm	PRX	14,08	1	3851-34-1.1-6/10
41 mm	PRX	18,24	1	3851-41-1.3-1.4/2
41 mm	PRX	18,24	1	3851-41-1.3-2/3
41 mm	PRX	18,24	1	3851-41-1.3-3/4
41 mm	PRX	18,24	1	3851-41-1.3-4/6
41 mm	PRX	18,24	1	3851-41-1.3-5/8
54 mm	PRX	20,84	1	3851-54-1.3-1.4/2
54 mm	PRX	20,86	1	3851-54-1.3-2/3
54 mm	PRX	23,41	1	3851-54-1.3-3/4
54 mm	PRX	20,86	1	3851-54-1.3-4/6
54 mm	PR	20,86	1	3851-54-1.6-P-1.25
54 mm	PRX	20,86	1	3851-54-1.6-1/1.4
54 mm	PRX	20,86	1	3851-54-1.6-1.4/2
54 mm	PRX	20,86	1	3851-54-1.6-2/3
54 mm	PRX	20,86	1	3851-54-1.6-3/4
54 mm	PRX	20,86	1	3851-54-1.6-4/6
67 mm	PRX	36,13	1	3851-67-1.6-7/1
67 mm	PRX	36,13	1	3851-67-1.6-1/1.4
67 mm	PRX	36,13	1	3851-67-1.6-1.4/2
67 mm	PRX	36,13	1	3851-67-1.6-2/3
67 mm	PRX	36,13	1	3851-67-1.6-3/4
67 mm	PRX	36,13	1	3851-67-1.6-4/6
80 mm	PRX	54,27	1	3851-80-1.6-7/1
80 mm	PRX	54,27	1	3851-80-1.6-1/1.4
80 mm	PRX	54,27	1	3851-80-1.6-1.4/2

**Hoja de sierra King Cobra**

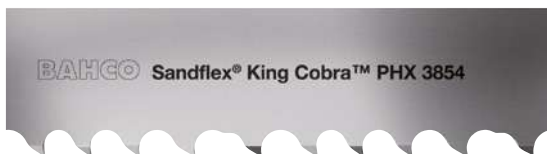

**3854-Sandflex® King Cobra™ PHX**

		€		
27 mm	PHX	10,76	1	3854-27-0.9-PHX-2/3
27 mm	PHX	10,76	1	3854-27-0.9-PHX-3/4
27 mm	PHX	10,76	1	3854-27-0.9-PHX-4/6

		€		
34 mm	PHX	15,07	1	3854-34-1.1-PHX-1.4/2
34 mm	PHX	15,07	1	3854-34-1.1-PHX-2/3
34 mm	PHX	15,07	1	3854-34-1.1-PHX-3/4
34 mm	PHX	15,07	1	3854-34-1.1-PHX-4/6
41 mm	PHX	19,52	1	3854-41-1.3-PHX-1.4/2
41 mm	PHX	19,52	1	3854-41-1.3-PHX-2/3
41 mm	PHX	19,52	1	3854-41-1.3-PHX-3/4
41 mm	PHX	19,52	1	3854-41-1.3-PHX-4/6
54 mm	PHX	27,18	1	3854-54-1.3-PHX-1.4/2
54 mm	PHX	27,18	1	3854-54-1.3-PHX-2/3
54 mm	PHX	27,18	1	3854-54-1.3-PHX-3/4
54 mm	PHX	30,79	1	3854-54-1.6-PHX-7/1
54 mm	PHX	30,79	1	3854-54-1.6-PHX-1/1.4
54 mm	PHX	30,79	1	3854-54-1.6-PHX-1.4/2
54 mm	PHX	30,79	1	3854-54-1.6-PHX-2/3
54 mm	PHX	30,79	1	3854-54-1.6-PHX-3/4
67 mm	PHX	38,67	1	3854-67-1.6-PHX-7/1
67 mm	PHX	38,67	1	3854-67-1.6-PHX-1/1.4
67 mm	PHX	38,67	1	3854-67-1.6-PHX-1.4/2
67 mm	PHX	38,67	1	3854-67-1.6-PHX-2/3
80 mm	PHX	58,07	1	3854-80-1.6-PHX-7/1
80 mm	PHX	58,07	1	3854-80-1.6-PHX-1/1.4
80 mm	PHX	58,07	1	3854-80-1.6-PHX-1.4/2

**Sandflex® King Cobra™ PQ**



**3854-Sandflex® King Cobra™ PQ**

		€		
27 mm	PQ	15,01	1	3854-27-0.9-PQ-3/4
27 mm	PQ	15,01	1	3854-27-0.9-PQ-4/6
34 mm	PQ	17,09	1	3854-34-1.1-PQ-2/3
34 mm	PQ	17,09	1	3854-34-1.1-PQ-3/4
34 mm	PQ	17,09	1	3854-34-1.1-PQ-4/6
41 mm	PQ	20,34	1	3854-41-1.3-PQ-1.4/2
41 mm	PQ	20,34	1	3854-41-1.3-PQ-2/3
41 mm	PQ	20,34	1	3854-41-1.3-PQ-3/4
41 mm	PQ	20,34	1	3854-41-1.3-PQ-4/6
54 mm	PQ	31,04	1	3854-54-1.6-PQ-9/1.2
54 mm	PQ	31,04	1	3854-54-1.6-PQ-1.4/2
54 mm	PQ	31,04	1	3854-54-1.6-PQ-2/3
54 mm	PQ	31,04	1	3854-54-1.6-PQ-3/4
54 mm	PQ	31,04	1	3854-54-1.6-PQ-4/6
67 mm	PQ	40,30	1	3854-67-1.6-PQ-9/1.2
67 mm	PQ	40,30	1	3854-67-1.6-PQ-1.4/2
67 mm	PQ	40,30	1	3854-67-1.6-PQ-2/3
80 mm	PQ	59,60	1	3854-80-1.6-PQ-9/1.2
80 mm	PQ	58,07	1	3854-80-1.6-PQ-1.4/2



Sandflex® King Cobra™ PQ



**3858 PQ P9000**

		€		
41 mm	PQ	26,40	1	3858-41-1.3-PQ-1.4/2
41 mm	PQ	26,40	1	3858-41-1.3-PQ-2/3
41 mm	PQ	26,40	1	3858-41-1.3-PQ-3/4
54 mm	PQ	40,23	1	3858-54-1.6-PQ-9/1.2
54 mm	PQ	40,23	1	3858-54-1.6-PQ-1.4/2
54 mm	PQ	40,23	1	3858-54-1.6-PQ-2/3
67 mm	PQ	52,80	1	3858-67-1.6-PQ-9/1.2
67 mm	PQ	52,80	1	3858-67-1.6-PQ-1.4/2
80 mm	PQ	75,44	1	3858-80-1.6-PQ-9/1.2

Hojas de sierra con dentado PHX

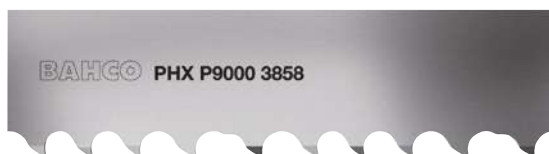

**3858 PHX P9000**

		€		
34 mm	PHX	15,97	1	3858-34-1.1-PHX-1.4/2
34 mm	PHX	15,97	1	3858-34-1.1-PHX-2/3
34 mm	PHX	15,97	1	3858-34-1.1-PHX-3/4
41 mm	PHX	21,37	1	3858-41-1.3-PHX-1.4/2
41 mm	PHX	21,37	1	3858-41-1.3-PHX-2/3
41 mm	PHX	21,37	1	3858-41-1.3-PHX-3/4
54 mm	PHX	27,66	1	3858-54-1.3-PHX-1.4/2
54 mm	PHX	27,66	1	3858-54-1.3-PHX-2/3
54 mm	PHX	27,66	1	3858-54-1.3-PHX-3/4
54 mm	PHX	27,66	1	3858-54-1.6-PHX-7/1
54 mm	PHX	27,66	1	3858-54-1.6-PHX-1/1.4
54 mm	PHX	27,66	1	3858-54-1.6-PHX-1.4/2
54 mm	PHX	27,66	1	3858-54-1.6-PHX-2/3
54 mm	PHX	27,66	1	3858-54-1.6-PHX-3/4
67 mm	PHX	37,72	1	3858-67-1.6-PHX-7/1
67 mm	PHX	37,72	1	3858-67-1.6-PHX-1/1.4
67 mm	PHX	37,72	1	3858-67-1.6-PHX-1.4/2
67 mm	PHX	37,72	1	3858-67-1.6-PHX-2/3
80 mm	PHX	44,51	1	3858-80-1.6-PHX-7/1
80 mm	PHX	44,51	1	3858-80-1.6-PHX-1/1.4
80 mm	PHX	44,51	1	3858-80-1.6-PHX-1.4/2

Sandflex® Top Fabricator



**3853 Sandflex® Top Fabricator**

		€		
20 mm	PF	10,34	1	3853-20-0.9-5/7-VS
20 mm	PF	10,34	1	3853-20-0.9-8/11-VS
27 mm	PF	10,74	1	3853-27-0.9-3/4
27 mm	PF	10,74	1	3853-27-0.9-4/6
27 mm	PF	10,74	1	3853-27-0.9-5/8
27 mm	PF	10,74	1	3853-27-0.9-5/7-VS
27 mm	PF	10,74	1	3853-27-0.9-8/11-VS
34 mm	PF	13,30	1	3853-34-1.1-2/3
34 mm	PF	13,30	1	3853-34-1.1-3/4
34 mm	PF	13,30	1	3853-34-1.1-4/6
34 mm	PF	13,30	1	3853-34-1.1-5/8
34 mm	PF	13,30	1	3853-34-1.1-5/7-VS
34 mm	PF	13,30	1	3853-34-1.1-8/11-VS
41 mm	PF	20,60	1	3853-41-1.3-2/3
41 mm	PF-W	20,60	1	3853-41-1.3-2/3-W
41 mm	PF	20,60	1	3853-41-1.3-3/4
41 mm	PF-W	20,60	1	3853-41-1.3-3/4-W
41 mm	PF	20,60	1	3853-41-1.3-4/6
41 mm	PF	20,60	1	3853-41-1.3-5/8
41 mm	PF	20,60	1	3853-41-1.3-5/7-VS
54 mm	PF	25,30	1	3853-54-1.3-3/4
54 mm	PF	25,30	1	3853-54-1.3-3/4-W
54 mm	PF	25,30	1	3853-54-1.3-5/8
54 mm	PF	25,30	1	3853-54-1.6-2/3
54 mm	PF-W	25,30	1	3853-54-1.6-2/3-W
54 mm	PF	25,30	1	3853-54-1.6-3/4
54 mm	PF-W	25,30	1	3853-54-1.6-3/4-W
54 mm	PF	25,30	1	3853-54-1.6-4/6
67 mm	PF	35,95	1	3853-67-1.6-2/3
67 mm	PF-W	35,95	1	3853-67-1.6-2/3-W
67 mm	PF	35,95	1	3853-67-1.6-3/4
67 mm	PF-W	35,95	1	3853-67-1.6-3/4-W
67 mm	PF-W	35,95	1	3853-67-1.6-5/8-W

Hoja de sierra Sandflex™ Top Fabricator



**3853 Sandflex® Top Fabricator Coated**

		€		
41 mm	PF	53,41	1	3853-41-1.3-2/3-WS
41 mm	PF	50,34	1	3853-41-1.3-3/4-WS
54 mm	PF	58,85	1	3853-54-1.6-2/3-WS
54 mm	PF	55,07	1	3853-54-1.6-3/4-WS
67 mm	PF	65,61	1	3853-67-1.6-2/3-WS
67 mm	PF	63,87	1	3853-67-1.6-3/4-WS

## SIERRAS DE CINTA TRIMETÁLICAS PARA EL CORTE DE METAL

Hojas de sierra de cinta de metal duro Extreme Easy-Cut



### 3859 Carbide Easy-Cut EZX

		€		
27 mm	EZX	33,10	1	3859-27-0.9-EZX-3/4
27 mm	EZX	43,28	1	3859-27-0.9-EZX-4/6
34 mm	EZX	32,67	1	3859-34-1.1-EZX-2/3
34 mm	EZX	41,59	1	3859-34-1.1-EZX-3/4
34 mm	EZX	44,98	1	3859-34-1.1-EZX-4/6
41 mm	EZX	31,30	1	3859-41-1.3-EZX-1.4/2
41 mm	EZX	35,33	1	3859-41-1.3-EZX-2/3
41 mm	EZX	45,52	1	3859-41-1.3-EZX-3/4
41 mm	EZX	47,64	1	3859-41-1.3-EZX-4/6
54 mm	EZX	44,45	1	3859-54-1.6-EZX-1.4/2
54 mm	EZX	40,42	1	3859-54-1.6-EZX-1/1.25
54 mm	EZX	46,04	1	3859-54-1.6-EZX-2/3
54 mm	EZX	49,44	1	3859-54-1.6-EZX-3/4
54 mm	EZX	58,45	1	3859-54-1.6-EZX-4/6
67 mm	EZX	40,63	1	3859-67-1.6-EZX-7/1
67 mm	EZX	48,06	1	3859-67-1.6-EZX-1.4/2
67 mm	EZX	44,03	1	3859-67-1.6-EZX-1/1.25
67 mm	EZX	58,89	1	3859-67-1.6-EZX-2/3
80 mm	EZX	42,76	1	3859-80-1.6-EZX-7/1
80 mm	EZX	50,71	1	3859-80-1.6-EZX-1.4/2
80 mm	EZX	79,57	1	3859-80-1.6-EZX-1/1.25

## Carbide Triple Set® "Xtra"™



### 3868 Carbide Triple Set® TSX

		€		
27 mm	TSX	90,11	1	3868-27-0.9-TSX-3/4
34 mm	TSX	59,05	1	3868-34-1.1-TSX-2
34 mm	TSX	71,91	1	3868-34-1.1-TSX-2/3
34 mm	TSX	88,67	1	3868-34-1.1-TSX-3/4
41 mm	TSX	72,61	1	3868-41-1.3-TSX-1.4/2
41 mm	TSX	63,11	1	3868-41-1.3-TSX-1.6
41 mm	TSX	62,01	1	3868-41-1.3-TSX-2
41 mm	TSX	77,12	1	3868-41-1.3-TSX-2/3
41 mm	TSX	94,89	1	3868-41-1.3-TSX-3/4
54 mm	TSX	94,22	1	3868-54-1.3-TSX-1.4/2
54 mm	TSX	95,80	1	3868-54-1.3-TSX-2/3
54 mm	TSX	95,95	1	3868-54-1.6-TSX-1/1.25
54 mm	TSX	104,92	1	3868-54-1.6-TSX-1.4/2
54 mm	TSX	91,23	1	3868-54-1.6-TSX-1.6
54 mm	TSX	96,08	1	3868-54-1.6-TSX-2/3
54 mm	TSX	96,08	1	3868-54-1.6-TSX-3/4
67 mm	TSX	126,10	1	3868-67-1.6-TSX-7/1
67 mm	TSX	131,25	1	3868-67-1.6-TSX-1/1.25
67 mm	TSX	134,21	1	3868-67-1.6-TSX-1.4/2
67 mm	TSX	134,21	1	3868-67-1.6-TSX-2/3
80 mm	TSX	211,20	1	3868-80-1.1-TSX-3/4
80 mm	TSX	134,21	1	3868-80-1.6-TSX-7/1
80 mm	TSX	143,32	1	3868-80-1.6-TSX-1/1.25
80 mm	TSX	133,28	1	3868-80-1.6-TSX-1.4/2
80 mm	TSX	186,06	1	3868-80-1.6-TSX-2/3

## SIERRAS DE CINTA DE METAL DURO PARA METAL

Carbide Triple Set



### 3869 Carbide Triple Set®

		€		
13 mm	TS	55,61	1	3869-13-0.9-TS-3
20 mm	TS	57,50	1	3869-20-0.9-TS-3
20 mm	TS	83,89	1	3869-20-0.9-TS-4
27 mm	TS	57,50	1	3869-27-0.9-TS-3
27 mm	TS	83,89	1	3869-27-0.9-TS-4
34 mm	TS	36,33	1	3869-34-1.1-TS-2
34 mm	TS	61,27	1	3869-34-1.1-TS-3

## Carbide TSS Triple Set



### 3868 Carbide Triple Set® TSS

		€		
27 mm	TSS	90,11	1	3868-27-0.9-TSS-3/4
34 mm	TSS	73,35	1	3868-34-1.1-TSS-2/3
34 mm	TSS	87,40	1	3868-34-1.1-TSS-3/4
41 mm	TSS	79,95	1	3868-41-1.3-TSS-1.4/2
41 mm	TSS	79,10	1	3868-41-1.3-TSS-2/3
54 mm	TSS	117,41	1	3868-54-1.6-TSS-1/1.25
54 mm	TSS	115,31	1	3868-54-1.6-TSS-1.4/2
54 mm	TSS	121,64	1	3868-54-1.6-TSS-2/3
67 mm	TSS	126,10	1	3868-67-1.6-TSS-7/1
67 mm	TSS	134,21	1	3868-67-1.6-TSS-1/1.25
67 mm	TSS	134,21	1	3868-67-1.6-TSS-1.4/2
67 mm	TSS	134,21	1	3868-67-1.6-TSS-2/3
80 mm	TSS	134,21	1	3868-80-1.6-TSS-7/1
80 mm	TSS	160,92	1	3868-80-1.6-TSS-1.4/2
80 mm	TSS	186,06	1	3868-80-1.6-TSS-2/3





3881 Carbide Multi Chip THQ



**3881 Carbide Multi Set THQ**

		€			
34 mm	THQ	82,52	1		3881-34-1.1-THQ-2/3
41 mm	THQ	83,61	1		3881-41-1.3-THQ-1.4/2
41 mm	THQ	88,67	1		3881-41-1.3-THQ-2/3
54 mm	THQ	110,46	1		3881-54-1.6-THQ-1.4/2
54 mm	THQ	110,59	1		3881-54-1.6-THQ-1/1.25
54 mm	THQ	110,48	1		3881-54-1.6-THQ-2/3
67 mm	THQ	137,54	1		3881-67-1.6-THQ-1/1.25
67 mm	THQ	137,54	1		3881-67-1.6-THQ-1.4/2
67 mm	THQ	85,70	1		3881-67-1.6-THQ-2/3
80 mm	THQ	143,32	1		3881-80-1.6-THQ-7/1
80 mm	THQ	150,04	1		3881-80-1.6-THQ-1/1.25
80 mm	THQ	143,32	1		3881-80-1.6-THQ-1.4/2
80 mm	THQ	198,64	1		3881-80-1.6-THQ-2/3

3881 Carbide Multi Chip THS



**3881 Carbide Multi Set THS**

		€			
41 mm	THS	91,95	1		3881-41-1.3-THS-1.4/2
54 mm	THS	121,49	1		3881-54-1.6-THS-1/1.25
54 mm	THS	121,49	1		3881-54-1.6-THS-1.4/2
67 mm	THS	150,04	1		3881-67-1.6-THS-1/1.25
67 mm	THS	150,04	1		3881-67-1.6-THS-1.4/2
67 mm	THS	150,62	1		3881-67-1.6-THS-2/3
80 mm	THS	155,90	1		3881-80-1.6-THS-7/1
80 mm	THS	155,90	1		3881-80-1.6-THS-1.4/2
80 mm	THS	198,64	1		3881-80-1.6-THS-2/3
100 mm	THS	78,07	1		3881-100-1.6-THS-7/1

Sierra cinta 3860 Carbide dentado especial para Titanio



**3860 Unset Carbide TMC**

		€			
41 mm	TMC	100,02	1		3860-41-1.3-TMC-1.4/2
41 mm	TMC	117,03	1		3860-41-1.3-TMC-2/3
54 mm	TMC	118,42	1		3860-54-1.3-TMC-1.4/2
54 mm	TMC	137,04	1		3860-54-1.3-TMC-2/3
54 mm	TMC	92,70	1		3860-54-1.6-TMC-7/1
54 mm	TMC	117,53	1		3860-54-1.6-TMC-1/1.25
54 mm	TMC	110,02	1		3860-54-1.6-TMC-1.4/2
54 mm	TMC	151,06	1		3860-54-1.6-TMC-2/3
67 mm	TMC	130,03	1		3860-67-1.6-TMC-1/1.25
67 mm	TMC	125,03	1		3860-67-1.6-TMC-1.4/2
67 mm	TMC	154,21	1		3860-67-1.6-TMC-2/3
80 mm	TMC	116,67	1		3860-80-1.1-TMC-1.4/2
80 mm	TMC	140,04	1		3860-80-1.6-TMC-7/1
80 mm	TMC	146,90	1		3860-80-1.6-TMC-1/1.25
80 mm	TMC	153,79	1		3860-80-1.6-TMC-1.4/2
80 mm	TMC	155,64	1		3860-80-1.6-TMC-2/3
100 mm	TMC	120,44	1		3860-100-1.1-TMC-1.4/2

3860 TCD - Sierra cinta Metal Duro sin triscado



**3860 Unset Carbide TCD**

		€			
27 mm	TCD	99,35	1		3860-27-0.9-TCD-3
27 mm	TCD	94,18	1		3860-27-0.9-TCD-3/4
34 mm	TCD	72,85	1		3860-34-1.1-TCD-2/3
34 mm	TCD	103,99	1		3860-34-1.1-TCD-3/4
34 mm	TCD	103,99	1		3860-34-1.1-TCD-3/4-W
41 mm	TCD	65,84	1		3860-41-1.3-TCD-1.4/2
41 mm	TCD	70,56	1		3860-41-1.3-TCD-1.9/2.1
41 mm	TCD	73,49	1		3860-41-1.3-TCD-2/3
41 mm	TCD	109,81	1		3860-41-1.3-TCD-3/4
54 mm	TCD	83,83	1		3860-54-1.6-TCD-1.4/2
54 mm	TCD	68,40	1		3860-54-1.6-TCD-1.9/2.1
54 mm	TCD	100,64	1		3860-54-1.6-TCD-2/3
54 mm	TCD	139,75	1		3860-54-1.6-TCD-3/4
67 mm	TCD	89,64	1		3860-67-1.6-TCD-1.4/2
67 mm	TCD	63,27	1		3860-67-1.6-TCD-1/1.25
80 mm	TCD	96,68	1		3860-80-1.6-TCD-5/0.8







### 3860 TCZ - Sierra cinta metal duro sin triscado



#### 3860 Unset Carbide TCZ



		€			
27 mm	TCZ	92,14	1		3860-27-0.9-TCZ-3/4
34 mm	TCZ	72,88	1		3860-34-1.1-TCZ-2/3
34 mm	TCZ	103,98	1		3860-34-1.1-TCZ-3/4
41 mm	TCZ	71,75	1		3860-41-1.3-TCZ-2/3
41 mm	TCZ	109,81	1		3860-41-1.3-TCZ-3/4





Dentado especial para corte barras tratadas al cromo duro

### 3860 TCA- Sierra cinta sin triscado multiviruta



#### 3860 Unset Carbide TCA



		€			
27 mm	TCA	72,81	1		3860-27-0.9-TCA-3
34 mm	TCA	59,90	1		3860-34-1.1-TCA-2/3
34 mm	TCA	79,16	1		3860-34-1.1-TCA-3
41 mm	TCA	54,36	1		3860-41-1.3-TCA-1.4/2
41 mm	TCA	68,93	1		3860-41-1.3-TCA-2/3
54 mm	TCA	76,22	1		3860-54-1.6-TCA-.8/1
54 mm	TCA	56,02	1		3860-54-1.6-TCA-1/1.25
54 mm	TCA	68,93	1		3860-54-1.6-TCA-1.4/2
80 mm	TCA	81,18	1		3860-80-1.6-TCA-.8/1



Geometría del dentado especial para aluminio

### Hojas se sierra recubiertas



#### 3860 Unset Carbide TMC Coated







		€			
54 mm	TMC	118,74	1		3860-54-1.6-TMC-1/1.25S
54 mm	TMC	122,23	1		3860-54-1.6-TMC-1.4/2S
54 mm	TMC	133,87	1		3860-54-1.6-TMC-2/3S
67 mm	TMC	128,05	1		3860-67-1.6-TMC-1/1.25S
67 mm	TMC	133,87	1		3860-67-1.6-TMC-1.4/2S

### HOJA DE SIERRA PARA MADERA

#### Sandcut® Bi-Metal



#### 3861 Sandcut Bi-metal

		€			
4	Hook	2,97	1		3861-20-0.6-H-4
1.33	Hook	3,94	1		3861-27-0.9-H-1.33
1.15	Hook	8,98	1		3861-34-0.9-H-1.15
1.15	Hook	8,98	1		3861-34-1.1-H-1.15
1.15	Hook	11,92	1		3861-41-1.1-H-1.15
1.15	Hook	13,47	1		3861-54-1.1-H-1.15



## Sandcut® Sólido

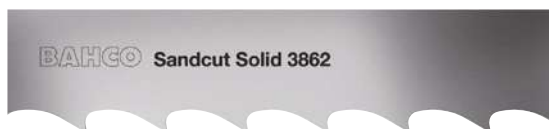

### 3862 Sandcut Solid

		€		
1.15	Hook	14,54	1	3862-33-0.9-H-1.15
1.15	Hook	14,54	1	3862-33-1.1-H-1.15
1.15	Hook	15,54	1	3862-40-1.1-H-1.15

## SIERRAS DE CINTA PARA CORTE DE AISLAMIENTO

Hojas de sierra de cinta Sandflex® con doble punta aislante



### 3852 Sandflex® Twin Tip Insulation

		€		
27 mm	INS	13,79	1	3852-27-0.9-INS-3
34 mm	INS	14,85	1	3852-34-1.1-INS-3

## SIERRAS CIRCULARES DE ACERO RÁPIDO

Sierra circular acero rápido



### 3815-32-1

		€		
200 mm	BW3	85,44	1	3815-200-2.0-32-1-03BW
200 mm	BW4	106,80	1	3815-200-2.0-32-1-04BW
225 mm	BW3	129,36	1	3815-225-2.0-32-1-03BW
225 mm	BW4	129,36	1	3815-225-2.0-32-1-04BW

		€		
225 mm	BW5	129,36	1	3815-225-2.0-32-1-05BW
225 mm	C6	129,36	1	3815-225-2.0-32-1-06C
250 mm	BW3	141,91	1	3815-250-2.0-32-1-03BW
250 mm	BW4	141,91	1	3815-250-2.0-32-1-04BW
250 mm	BW5	141,91	1	3815-250-2.0-32-1-05BW
250 mm	C6	141,91	1	3815-250-2.0-32-1-06C
275 mm	BW4	196,55	1	3815-275-2.5-32-1-04BW
275 mm	BW5	196,55	1	3815-275-2.5-32-1-05BW
275 mm	C6	196,55	1	3815-275-2.5-32-1-06C
275 mm	C8	196,55	1	3815-275-2.5-32-1-08C
300 mm	BW4	242,34	1	3815-300-2.5-32-1-04BW
300 mm	BW5	242,34	1	3815-300-2.5-32-1-05BW
300 mm	C5	242,34	1	3815-300-2.5-32-1-05C
300 mm	C6	242,34	1	3815-300-2.5-32-1-06C
300 mm	C8	242,34	1	3815-300-2.5-32-1-08C
315 mm	BW4	292,42	1	3815-315-2.5-32-1-04BW
315 mm	BW5	292,42	1	3815-315-2.5-32-1-05BW
315 mm	C6	292,42	1	3815-315-2.5-32-1-06C
315 mm	C8	292,42	1	3815-315-2.5-32-1-08C
350 mm	BW4	409,69	1	3815-350-2.5-32-1-04BW
350 mm	C6	409,69	1	3815-350-2.5-32-1-06C

Sierra circular en acero rápido



### 3815-40-2

		€		
250 mm	BW3	141,91	1	3815-250-2.0-40-2-03BW
250 mm	BW4	141,91	1	3815-250-2.0-40-2-04BW
250 mm	BW5	141,91	1	3815-250-2.0-40-2-05BW
275 mm	BW3	196,55	1	3815-275-2.5-40-2-03BW
275 mm	BW4	196,55	1	3815-275-2.5-40-2-04BW
275 mm	BW5	196,55	1	3815-275-2.5-40-2-05BW
275 mm	C6	196,55	1	3815-275-2.5-40-2-06C
275 mm	C8	196,55	1	3815-275-2.5-40-2-08C
315 mm	BW4	292,42	1	3815-315-2.5-40-2-04BW
315 mm	BW5	292,42	1	3815-315-2.5-40-2-05BW
315 mm	C6	312,05	1	3815-315-3.0-40-2-06C

Sierra circular en acero rápido



**3815-50-4**

Ø	V	€		
370 mm	C8	409,69	1	3815-370-3.0-50-4-08C
370 mm	C10	409,69	1	3815-370-3.0-50-4-10C
400 mm	C10	538,56	1	3815-400-3.5-50-4-10C

**HOJAS DE SIERRA DE MÁQUINA**

Hoja de sierra para máquinas Sandflex® Bi-metal

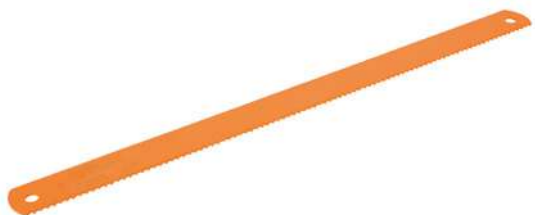

**3809**

	L	€		
10	300 mm	11,03	10	3809-300-25-1.25-10
14	300 mm	11,09	10	3809-300-25-1.25-14
6	300 mm	15,78	10	3809-300-32-1.60-6
10	300 mm	15,90	10	3809-300-32-1.60-10
6	350 mm	12,88	10	3809-350-25-1.25-6
10	350 mm	12,88	10	3809-350-25-1.25-10
14	350 mm	12,88	10	3809-350-25-1.25-14
4	350 mm	16,97	10	3809-350-32-1.60-4
6	350 mm	16,97	10	3809-350-32-1.60-6





	L	€		
8	350 mm	16,97	10	3809-350-32-1.60-8
10	350 mm	16,97	10	3809-350-32-1.60-10
14	350 mm	16,97	10	3809-350-32-1.60-14
4	350 mm	22,74	10	3809-350-32-2.00-4
6	350 mm	22,74	10	3809-350-32-2.00-6
10	350 mm	22,74	10	3809-350-32-2.00-10
6	350 mm	28,49	10	3809-350-38-2.00-6
10	350 mm	28,49	10	3809-350-38-2.00-10
10	400 mm	16,39	10	3809-400-25-1.25-10
4	400 mm	21,57	10	3809-400-32-1.60-4
6	400 mm	21,57	10	3809-400-32-1.60-6
8	400 mm	21,57	10	3809-400-32-1.60-8
10	400 mm	21,57	10	3809-400-32-1.60-10
14	400 mm	21,57	10	3809-400-32-1.60-14
4	400 mm	25,30	10	3809-400-32-2.00-4
6	400 mm	25,30	10	3809-400-32-2.00-6
8	400 mm	25,80	10	3809-400-32-2.00-8
10	400 mm	25,30	10	3809-400-32-2.00-10
4	400 mm	28,84	10	3809-400-38-2.00-4
6	400 mm	28,84	10	3809-400-38-2.00-6
10	400 mm	28,84	10	3809-400-38-2.00-10
6	425 mm	25,47	10	3809-425-32-1.60-6
10	425 mm	28,84	10	3809-425-32-1.60-10
4	450 mm	26,94	10	3809-450-32-1.60-4
6	450 mm	26,94	10	3809-450-32-1.60-6
10	450 mm	26,94	10	3809-450-32-1.60-10
14	450 mm	26,94	10	3809-450-32-1.60-14
4	450 mm	31,75	10	3809-450-32-2.00-4
6	450 mm	31,75	10	3809-450-32-2.00-6
10	450 mm	31,75	10	3809-450-32-2.00-10
4	450 mm	36,11	10	3809-450-38-2.00-4
6	450 mm	36,11	10	3809-450-38-2.00-6
8	450 mm	36,11	10	3809-450-38-2.00-8
10	450 mm	36,11	10	3809-450-38-2.00-10
4	450 mm	45,24	10	3809-450-45-2.25-4
6	450 mm	45,24	10	3809-450-45-2.25-6
6	475 mm	52,27	10	3809-475-45-2.25-6
4	500 mm	42,19	10	3809-500-38-2.00-4
6	500 mm	42,19	10	3809-500-38-2.00-6
10	500 mm	42,19	10	3809-500-38-2.00-10
4	500 mm	54,04	10	3809-500-45-2.25-4
6	500 mm	54,04	10	3809-500-45-2.25-6
4	500 mm	63,87	10	3809-500-50-2.50-4
6	500 mm	63,87	10	3809-500-50-2.50-6
8	500 mm	64,82	10	3809-500-50-2.50-8
6	525 mm	44,09	10	3809-525-38-2.00-6
10	525 mm	44,09	10	3809-525-38-2.00-10
4	525 mm	56,50	10	3809-525-45-2.25-4
6	525 mm	56,50	10	3809-525-45-2.25-6
4	550 mm	59,42	10	3809-550-45-2.25-4
6	550 mm	59,42	10	3809-550-45-2.25-6
4	550 mm	70,81	10	3809-550-50-2.50-4
6	550 mm	70,81	10	3809-550-50-2.50-6
4	575 mm	64,73	10	3809-575-45-2.25-4
3	575 mm	73,84	10	3809-575-50-2.50-3
4	575 mm	73,84	10	3809-575-50-2.50-4
6	575 mm	73,84	10	3809-575-50-2.50-6
6	600 mm	52,49	10	3809-600-38-2.00-6
4	600 mm	64,94	10	3809-600-45-2.25-4
6	600 mm	64,94	10	3809-600-45-2.25-6
3	600 mm	78,54	10	3809-600-50-2.50-3
4	600 mm	78,54	10	3809-600-50-2.50-4
6	600 mm	78,54	10	3809-600-50-2.50-6
4	650 mm	87,45	5	3809-650-50-2.50-4
6	650 mm	87,45	5	3809-650-50-2.50-6
4	700 mm	95,54	5	3809-700-50-2.50-4
6	700 mm	95,54	5	3809-700-50-2.50-6
4	750 mm	111,50	5	3809-750-50-2.50-4
6	750 mm	111,50	5	3809-750-50-2.50-6



Sandflex® Bi-metal hoja de sierra para máquina KASTO







**3809 KA**

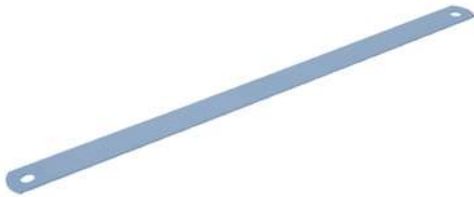



		€			
6	400 mm	25,33	10		3809-400-32-2.00-6-KA
4	450 mm	36,11	10		3809-450-38-2.00-4-KA
6	450 mm	36,11	10		3809-450-38-2.00-6-KA
10	450 mm	36,11	10		3809-450-38-2.00-10-KA
6	500 mm	54,04	10		3809-500-45-2.25-6-KA
4	500 mm	63,87	10		3809-500-50-2.50-4-KA
6	500 mm	63,87	10		3809-500-50-2.50-6-KA
4	550 mm	70,81	10		3809-550-50-2.50-4-KA
6	550 mm	70,81	10		3809-550-50-2.50-6-KA
3	575 mm	73,84	10		3809-575-50-2.50-3-KA
4	575 mm	73,84	10		3809-575-50-2.50-4-KA
6	575 mm	73,84	10		3809-575-50-2.50-6-KA
10	575 mm	73,84	10		3809-575-50-2.50-10-KA
4	600 mm	78,54	10		3809-600-50-2.50-4-KA
6	600 mm	78,54	10		3809-600-50-2.50-6-KA
3	650 mm	87,45	5		3809-650-50-2.50-3-KA
4	650 mm	87,45	5		3809-650-50-2.50-4-KA
6	650 mm	87,45	5		3809-650-50-2.50-6-KA
3	700 mm	95,54	5		3809-700-50-2.50-3-KA
4	700 mm	95,54	5		3809-700-50-2.50-4-KA
6	700 mm	95,54	5		3809-700-50-2.50-6-KA

Hoja de sierra para máquinas HSS



**3802**





		€			
6	300 mm	12,25	10		3802-300-25-1.25-6
10	300 mm	12,25	10		3802-300-25-1.25-10
14	300 mm	12,30	10		3802-300-25-1.25-14
6	300 mm	17,66	10		3802-300-32-1.60-6
10	300 mm	17,92	10		3802-300-32-1.60-10
6	350 mm	14,39	10		3802-350-25-1.25-6
10	350 mm	14,39	10		3802-350-25-1.25-10
14	350 mm	14,39	10		3802-350-25-1.25-14
4	350 mm	18,97	10		3802-350-32-1.60-4
6	350 mm	18,97	10		3802-350-32-1.60-6
8	350 mm	18,97	10		3802-350-32-1.60-8
10	350 mm	18,97	10		3802-350-32-1.60-10
14	350 mm	18,97	10		3802-350-32-1.60-14
6	400 mm	18,34	10		3802-400-25-1.25-6
10	400 mm	18,34	10		3802-400-25-1.25-10
14	400 mm	18,34	10		3802-400-25-1.25-14
4	400 mm	23,95	10		3802-400-32-1.60-4
6	400 mm	23,95	10		3802-400-32-1.60-6

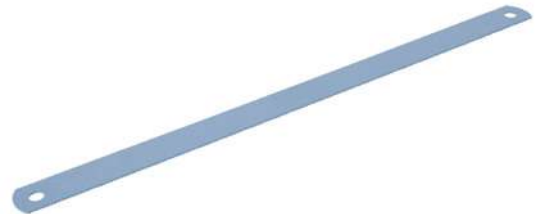



		€			
8	400 mm	23,95	10		3802-400-32-1.60-8
10	400 mm	23,95	10		3802-400-32-1.60-10
14	400 mm	23,95	10		3802-400-32-1.60-14
4	400 mm	31,98	10		3802-400-38-2.00-4
6	400 mm	31,98	10		3802-400-38-2.00-6
10	400 mm	31,98	10		3802-400-38-2.00-10
6	425 mm	28,42	10		3802-425-32-1.60-6
10	425 mm	28,92	10		3802-425-32-1.60-10
4	450 mm	29,93	10		3802-450-32-1.60-4
6	450 mm	29,93	10		3802-450-32-1.60-6
10	450 mm	29,93	10		3802-450-32-1.60-10
14	450 mm	29,93	10		3802-450-32-1.60-14
4	450 mm	40,15	10		3802-450-38-2.00-4
6	450 mm	40,15	10		3802-450-38-2.00-6
8	450 mm	40,15	10		3802-450-38-2.00-8
10	450 mm	40,15	10		3802-450-38-2.00-10
8	475 mm	42,96	10		3802-475-38-2.00-8
4	500 mm	47,15	10		3802-500-38-2.00-4
6	500 mm	47,15	10		3802-500-38-2.00-6
8	500 mm	47,15	10		3802-500-38-2.00-8
10	500 mm	47,15	10		3802-500-38-2.00-10
10	500 mm	66,42	10		3802-500-45-2.25-10
4	500 mm	71,12	10		3802-500-50-2.50-4
6	500 mm	71,12	10		3802-500-50-2.50-6
6	525 mm	49,06	10		3802-525-38-2.00-6
8	525 mm	43,92	10		3802-525-38-2.00-8
10	525 mm	49,53	10		3802-525-38-2.00-10
6	550 mm	46,15	10		3802-550-38-2.00-6
4	550 mm	78,21	10		3802-550-50-2.50-4
6	550 mm	78,60	10		3802-550-50-2.50-6
8	550 mm	80,18	5		3802-550-50-2.50-8
10	550 mm	80,18	10		3802-550-50-2.50-10
4	575 mm	82,17	10		3802-575-50-2.50-4
6	575 mm	82,17	10		3802-575-50-2.50-6
4	600 mm	87,53	10		3802-600-50-2.50-4
6	600 mm	87,53	10		3802-600-50-2.50-6
8	600 mm	87,53	10		3802-600-50-2.50-8
4	650 mm	97,34	5		3802-650-50-2.50-4
6	650 mm	97,34	5		3802-650-50-2.50-6
3	700 mm	93,51	5		3802-700-50-2.50-3
4	700 mm	106,40	5		3802-700-50-2.50-4
6	700 mm	106,40	5		3802-700-50-2.50-6
4	750 mm	124,10	5		3802-750-50-2.50-4
6	750 mm	113,34	5		3802-750-50-2.50-6

Hoja de sierra para máquinas KASTO HSS



**3802 KA**

		€			
4	450 mm	40,15	10		3802-450-38-2.00-4-KA
6	450 mm	40,15	10		3802-450-38-2.00-6-KA
8	450 mm	40,15	10		3802-450-38-2.00-8-KA
10	450 mm	40,15	10		3802-450-38-2.00-10-KA
4	500 mm	71,12	10		3802-500-50-2.50-4-KA
6	500 mm	71,12	10		3802-500-50-2.50-6-KA
4	550 mm	78,60	10		3802-550-50-2.50-4-KA
8	550 mm	78,60	10		3802-550-50-2.50-8-KA
3	575 mm	82,17	10		3802-575-50-2.50-3-KA
4	575 mm	82,17	10		3802-575-50-2.50-4-KA



		€		
6	575 mm	82,17	10	3802-575-50-2.50-6-KA
4	650 mm	97,34	5	3802-650-50-2.50-4-KA
6	650 mm	88,85	5	3802-650-50-2.50-6-KA
2	700 mm	105,96	5	3802-700-50-2.50-2-KA
4	700 mm	106,40	5	3802-700-50-2.50-4-KA
6	700 mm	106,40	5	3802-700-50-2.50-6-KA

## ACCESORIOS PARA SIERRAS DE CINTA

Cepillo de virutas



### 3870-BRUSH

	€		
60 mm	23,09	4	3870-BRUSH-60-6
80 mm	26,78	4	3870-BRUSH-80-6
80 mm	26,78	4	3870-BRUSH-80-8
80 mm	26,78	4	3870-BRUSH-80-10
100 mm	34,28	4	3870-BRUSH-100-10
100 mm	25,36	4	3870-BRUSH-100-12
100 mm	34,28	4	3870-BRUSH-100-10-HEX
100 mm	34,28	1	3870-BRUSH-100-13

Tensiómetro



### 3870-TENSION

	€		
680 g	297,32	1	3870-TENSION METER

Refractómetro



### 3870-REFR

	€		
260 g	73,68	1	3870-REFRACTOMETER

Cuña metálica larga, 75mm



### 3870-WEDGE

	€		
60 g	4,66	1	3870-WEDGE-3

Rueda para ajuste de tensión de sierra cinta



### 3870-Wheel

	€		
0.7790 kg	62,86	1	3870-WHEEL







**BAHCO®**



# Limas



## LIMAS DE MECÁNICO

Lima plana paralela, embalaje industrial, sin mango



### 1-100...-0

		€		
100 mm	1	5,67	10	1-100-04-1-0
100 mm	2	5,08	10	1-100-04-2-0
100 mm	3	5,28	10	1-100-04-3-0
150 mm	1	5,28	10	1-100-06-1-0
150 mm	2	5,64	10	1-100-06-2-0
150 mm	3	5,85	10	1-100-06-3-0
200 mm	1	6,84	10	1-100-08-1-0
200 mm	2	7,26	10	1-100-08-2-0
200 mm	3	7,37	10	1-100-08-3-0
250 mm	1	8,93	10	1-100-10-1-0
250 mm	2	9,34	10	1-100-10-2-0
250 mm	3	9,49	10	1-100-10-3-0
300 mm	1	12,20	5	1-100-12-1-0
300 mm	2	12,47	5	1-100-12-2-0
300 mm	3	12,62	5	1-100-12-3-0
350 mm	1	17,44	5	1-100-14-1-0
350 mm	2	18,26	5	1-100-14-2-0

Tipo de picado: 1 = Basto, 2 = Entrefino, 3 = Fino

Lima paralela con mango



ergo



### 1-100...-2

		€		
100 mm	1	7,12	5	1-100-04-1-2
100 mm	2	7,26	5	1-100-04-2-2
150 mm	1	8,99	5	1-100-06-1-2
150 mm	2	9,07	5	1-100-06-2-2
150 mm	3	9,06	5	1-100-06-3-2
200 mm	1	9,84	5	1-100-08-1-2
200 mm	2	10,31	5	1-100-08-2-2
200 mm	3	11,46	5	1-100-08-3-2
250 mm	1	12,70	5	1-100-10-1-2
250 mm	2	13,10	5	1-100-10-2-2
250 mm	3	12,43	5	1-100-10-3-2
300 mm	1	15,67	5	1-100-12-1-2
300 mm	2	15,94	5	1-100-12-2-2
300 mm	3	14,66	5	1-100-12-3-2

Tipo de picado: 1 = Basto, 2 = Entrefino, 3 = Fino

Lima plana paralela, delgada



### 1-102

		€		
150 mm	2	7,95	10	1-102-06-2-0
150 mm	3	8,37	10	1-102-06-3-0
200 mm	1	9,49	10	1-102-08-1-0
200 mm	2	9,84	10	1-102-08-2-0
200 mm	3	9,96	10	1-102-08-3-0

Tipo de picado: 2 = Entrefino, 3 = Fino

Lima para torneear



### 1-104

		€		
250 mm	2	15,34	10	1-104-10-2-0
250 mm	3	15,88	10	1-104-10-3-0
300 mm	2	20,51	5	1-104-12-2-0
300 mm	3	22,03	5	1-104-12-3-0
350 mm	3	29,83	5	1-104-14-3-0

Tipo de picado: 2 = Entrefino, 3 = Fino

Lima plana paralela "Oberg Cut"



### 1-106...-0

		€		
200 mm	1	11,23	10	1-106-08-1-0
250 mm	1	15,63	10	1-106-10-1-0
300 mm	1	19,95	5	1-106-12-1-0

Limado Oberg



ergo



### 1-106...-2

		€		
200 mm	1	14,74	5	1-106-08-1-2
250 mm	1	18,87	5	1-106-10-1-2
300 mm	1	22,77	5	1-106-12-1-2

Lima plana



### 1-110...-0

		€		
100 mm	1	4,83	10	1-110-04-1-0
100 mm	2	5,08	10	1-110-04-2-0
100 mm	2	5,28	10	1-110-04-3-0
150 mm	1	5,28	10	1-110-06-1-0
150 mm	2	5,64	10	1-110-06-2-0
150 mm	3	5,85	10	1-110-06-3-0
200 mm	1	6,84	10	1-110-08-1-0
200 mm	2	7,26	10	1-110-08-2-0
200 mm	2	7,37	10	1-110-08-3-0
250 mm	1	8,93	10	1-110-10-1-0
250 mm	2	9,34	10	1-110-10-2-0
250 mm	3	9,49	10	1-110-10-3-0
300 mm	1	12,20	5	1-110-12-1-0
300 mm	2	12,47	5	1-110-12-2-0
300 mm	3	12,62	5	1-110-12-3-0
350 mm	1	17,44	5	1-110-14-1-0

Tipo de picado: 1 = Basto, 2 = Entrefino, 3 = Fino



## Lima plana



ergo



### 1-110...-2

			€		
150 mm	1	8,99	5	1-110-06-1-2	
150 mm	2	9,07	5	1-110-06-2-2	
150 mm	3	8,97	5	1-110-06-3-2	
200 mm	1	9,84	5	1-110-08-1-2	
200 mm	2	10,31	5	1-110-08-2-2	
200 mm	3	10,39	5	1-110-08-3-2	
250 mm	1	12,70	5	1-110-10-1-2	
250 mm	2	13,10	5	1-110-10-2-2	
250 mm	3	11,92	5	1-110-10-3-2	
300 mm	1	14,47	5	1-110-12-1-2	
300 mm	2	16,87	5	1-110-12-2-2	
300 mm	3	14,85	5	1-110-12-3-2	

Tipo de picado: 1 = Basto, 2 = Entrefino, 3 = Fino

## Lima plana, punta delgada



### 1-111...-0

			€		
100 mm	1	5,28	10	1-111-04-1-0	
100 mm	2	5,57	10	1-111-04-2-0	
100 mm	3	5,77	10	1-111-04-3-0	
150 mm	1	5,77	10	1-111-06-1-0	
150 mm	2	6,61	10	1-111-06-2-0	
150 mm	3	6,84	10	1-111-06-3-0	
200 mm	1	8,08	10	1-111-08-1-0	
200 mm	2	9,15	10	1-111-08-2-0	

Tipo de picado: 1 = Basto, 2 = Entrefino, 3 = Fino

## Lima plana, punta delgada



ergo



### 1-111...-2

			€		
150 mm	2	10,20	5	1-111-06-2-2	

## Lima de contacto



### 1-115

			€		
110 mm	3	10,76	10	1-115-11-3-1	

## Lima universal, 2 cantos planos (tipo USA)



### 1-143...-0

			€		
100 mm	1	4,38	10	1-143-04-1-0	
150 mm	1	4,76	10	1-143-06-1-0	
200 mm	1	6,14	10	1-143-08-1-0	
250 mm	1	8,08	10	1-143-10-1-0	
300 mm	1	11,02	5	1-143-12-1-0	

## Lima 2 cantos planos



ergo



### 1-143...-2

			€		
150 mm	1	8,79	5	1-143-06-1-2	
200 mm	1	10,11	5	1-143-08-1-2	
250 mm	1	12,06	5	1-143-10-1-2	
300 mm	1	15,19	5	1-143-12-1-2	

## Lima diagonal



ergo



### 1-320...-2

			€		
200 mm	2	22,09	5	1-320-08-2-2	
250 mm	2	24,11	5	1-320-10-2-2	

## Lima diagonal



### 1-320...-0

			€		
200 mm	2	18,26	10	1-320-08-2-0	
250 mm	2	20,22	10	1-320-10-2-0	
300 mm	2	22,29	5	1-320-12-2-0	

## Lima media caña



### 1-210...-0

			€		
100 mm	1	8,30	10	1-210-04-1-0	
100 mm	2	8,37	10	1-210-04-2-0	
100 mm	3	8,49	10	1-210-04-3-0	
150 mm	1	8,49	10	1-210-06-1-0	
150 mm	2	8,72	10	1-210-06-2-0	
150 mm	3	8,86	10	1-210-06-3-0	
200 mm	1	10,48	10	1-210-08-1-0	
200 mm	2	10,67	10	1-210-08-2-0	
200 mm	3	10,88	10	1-210-08-3-0	
250 mm	1	12,75	10	1-210-10-1-0	
250 mm	2	13,16	10	1-210-10-2-0	
250 mm	3	13,45	10	1-210-10-3-0	
300 mm	1	18,97	5	1-210-12-1-0	
300 mm	2	19,38	5	1-210-12-2-0	
300 mm	3	19,65	5	1-210-12-3-0	
350 mm	1	26,20	5	1-210-14-1-0	

Tipo de picado: 1 = Basto, 2 = Entrefino, 3 = Fino



## Lima de media caña



ergo®



### 1-210...-2

		€		
100 mm	1	10,31	5	1-210-04-1-2
100 mm	2	10,31	5	1-210-04-2-2
150 mm	1	10,75	5	1-210-06-1-2
150 mm	2	10,95	5	1-210-06-2-2
150 mm	3	11,64	5	1-210-06-3-2
200 mm	1	12,34	5	1-210-08-1-2
200 mm	2	13,26	5	1-210-08-2-2
200 mm	3	12,02	5	1-210-08-3-2
250 mm	1	16,61	5	1-210-10-1-2
250 mm	2	17,44	5	1-210-10-2-2
250 mm	3	14,64	5	1-210-10-3-2
300 mm	1	22,36	5	1-210-12-1-2
300 mm	2	22,61	5	1-210-12-2-2
300 mm	3	24,21	5	1-210-12-3-2

Tipo de picado: 1 = Basto, 2 = Entrefino, 3 = Fino

## Lima redonda con mango



ergo®



### 1-230...-2

		€		
100 mm	1	6,85	5	1-230-04-1-2
100 mm	2	7,17	5	1-230-04-2-2
150 mm	1	8,12	5	1-230-06-1-2
150 mm	2	8,29	5	1-230-06-2-2
150 mm	3	7,96	5	1-230-06-3-2
200 mm	1	9,15	5	1-230-08-1-2
200 mm	2	9,49	5	1-230-08-2-2
200 mm	3	9,19	5	1-230-08-3-2
250 mm	1	11,59	5	1-230-10-1-2
250 mm	2	12,13	5	1-230-10-2-2
250 mm	3	11,87	5	1-230-10-3-2
300 mm	1	14,32	5	1-230-12-1-2
300 mm	2	14,32	5	1-230-12-2-2
300 mm	3	13,76	5	1-230-12-3-2

Tipo de picado: 1 = basto/ 2 = entrefino/ 3 = fino

## Lima triangular



ergo®



### 1-170...-2

		€		
100 mm	2	8,99	5	1-170-04-2-2
150 mm	1	9,24	5	1-170-06-1-2
150 mm	2	9,72	5	1-170-06-2-2
150 mm	3	11,04	5	1-170-06-3-2
200 mm	1	11,64	5	1-170-08-1-2
200 mm	2	12,06	5	1-170-08-2-2
200 mm	3	14,34	5	1-170-08-3-2
250 mm	1	15,01	5	1-170-10-1-2
250 mm	2	15,04	5	1-170-10-2-2
250 mm	3	18,29	5	1-170-10-3-2

Tipo de picado: 1 = Basto, 2 = Entrefino, 3 = Fino

## Lima redonda



### 1-230...-0

		€		
100 mm	1	4,96	10	1-230-04-1-0
100 mm	2	5,23	10	1-230-04-2-0
100 mm	3	5,37	10	1-230-04-3-0
150 mm	1	5,57	10	1-230-06-1-0
150 mm	2	5,85	10	1-230-06-2-0
150 mm	3	5,96	10	1-230-06-3-0
200 mm	1	6,61	10	1-230-08-1-0
200 mm	2	7,02	10	1-230-08-2-0
200 mm	3	7,33	10	1-230-08-3-0
250 mm	1	8,08	10	1-230-10-1-0
250 mm	2	8,99	10	1-230-10-2-0
250 mm	3	9,63	10	1-230-10-3-0
300 mm	1	11,23	5	1-230-12-1-0
300 mm	2	11,87	5	1-230-12-2-0
300 mm	3	12,06	5	1-230-12-3-0

Tipo de picado: 1 = Basto, 2 = Entrefino, 3 = Fino

## Lima triangular



### 1-170...-0

		€		
100 mm	1	5,56	10	1-170-04-1-0
100 mm	2	5,59	10	1-170-04-2-0
100 mm	3	5,96	10	1-170-04-3-0
150 mm	1	6,25	10	1-170-06-1-0
150 mm	2	6,65	10	1-170-06-2-0
150 mm	3	6,84	10	1-170-06-3-0
200 mm	1	8,24	10	1-170-08-1-0
200 mm	2	8,72	10	1-170-08-2-0
200 mm	3	8,93	10	1-170-08-3-0
250 mm	1	11,64	10	1-170-10-1-0
250 mm	2	12,13	10	1-170-10-2-0
250 mm	3	12,42	10	1-170-10-3-0
300 mm	1	15,04	5	1-170-12-1-0
300 mm	2	16,30	5	1-170-12-2-0

Tipo de picado: 1 = Basto, 2 = Entrefino, 3 = Fino

## Lima cuadrada



### 1-160...-0

		€		
100 mm	1	5,75	10	1-160-04-1-0
100 mm	2	6,00	10	1-160-04-2-0
100 mm	3	6,14	10	1-160-04-3-0
150 mm	1	5,54	10	1-160-06-1-0
150 mm	2	5,96	10	1-160-06-2-0
150 mm	3	6,19	10	1-160-06-3-0
200 mm	1	6,64	10	1-160-08-1-0
200 mm	2	6,96	10	1-160-08-2-0
200 mm	3	7,12	10	1-160-08-3-0
250 mm	1	9,41	10	1-160-10-1-0
250 mm	2	9,89	10	1-160-10-2-0
250 mm	3	10,05	10	1-160-10-3-0
300 mm	1	13,52	5	1-160-12-1-0
300 mm	2	14,08	5	1-160-12-2-0
300 mm	3	16,58	5	1-160-12-3-0

Tipo de picado: 1 = Basto, 2 = Entrefino, 3 = Fino

## Lima cuadrada



ergo®



### 1-160...-2

		€		
100 mm	1	8,12	5	1-160-04-1-2
100 mm	2	8,49	5	1-160-04-2-2
150 mm	1	8,93	5	1-160-06-1-2

			€		
150 mm	2	8,99	5	1-160-06-2-2	
150 mm	3	9,40	5	1-160-06-3-2	
200 mm	1	10,05	5	1-160-08-1-2	
200 mm	2	10,48	5	1-160-08-2-2	
200 mm	3	12,02	5	1-160-08-3-2	
250 mm	1	12,42	5	1-160-10-1-2	
250 mm	2	13,26	5	1-160-10-2-2	
250 mm	3	14,64	5	1-160-10-3-2	
300 mm	1	17,89	5	1-160-12-1-2	
300 mm	2	17,53	5	1-160-12-2-2	
300 mm	3	17,69	5	1-160-12-3-2	

Tipo de picado: 1 = Basto, 2 = Entrefino, 3 = Fino

Juego 6 limas de mecánico, picado fino



ergo®



1-476

			€		
100 mm	3	50,57	1	1-476-04-3-2	

Tipo de picado: 3 = Fino 1-160-04-3-2, 1-111-04-3-2, 1-230-04-3-2, 1-170-04-3-2, 1-210-04-3-2, 1-100-04-3-2

Juego de 3 limas de mecánico ERGO™



ergo®



1-473

			€		
150 mm	2	29,32	5	1-473-06-2-2	

1-230-06-2-2

1-210-06-2-2

1-100-06-2-2

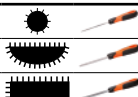

Juego de 3 limas de mecánico ERGO™



ergo®



1-473-08-2-2

			€		
200 mm	2	33,86	5	1-473-08-2-2	

1-230-08-2-2

1-210-08-2-2

1-100-08-2-2

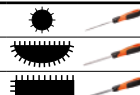

Juego de 3 limas de mecánico ERGO™



ergo®



1-473-10-2-2 1

			€		
250 mm	2	39,88	5	1-473-10-2-2	

1-230-10-2-2

1-210-10-2-2

1-100-10-2-2

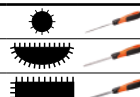

Juego de 5 limas de mecánico ERGO™



ergo®



1-477

			€		
200 mm	2	59,82	5	1-477-08-2-2	

1-100-08-2-2

1-210-08-2-2

6-343-08-2-2

1-230-08-2-2

1-170-08-2-2

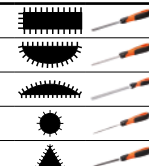

Juego de 5 limas de mecánico ERGO™



ergo®



1-477-10-2-2

			€		
250 mm	2	71,86	5	1-477-10-2-2	

1-100-10-2-2

1-210-10-2-2

6-343-10-2-2

1-230-10-2-2

1-170-10-2-2

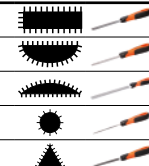

Juego de 5 limas de mecánico ERGO™



ergo



**1-478**

		€		
200 mm	1&2	54,21	5	1-478-08-1-2

1-210-08-1-2		
1-230-08-1-2		
1-100-08-1-2, 1-100-08-2-2		
1-160-08-1-2		

Juego de 5 limas de mecánico ERGO™



ergo



**1-478-10-1-2 1**

		€		
250 mm	1&2	64,52	5	1-478-10-1-2

1-210-10-1-2		
1-230-10-1-2		
1-100-10-1-2, 1-100-10-2-2		
1-160-10-1-2		

Juego de 5 limas de mecánico ERGO™



ergo



**1-479**

		€		
200 mm	1	63,71	5	1-479-08-1-2

4-138-08-1-2		
1-210-08-1-2		
6-343-08-2-2		
1-230-08-1-2		
1-100-08-1-2		

Juego de 5 limas de mecánico ERGO™



ergo



**1-479-08-2-2**

		€		
200 mm	2	64,79	5	1-479-08-2-2

4-138-08-1-2		
1-210-08-2-2		
6-343-08-2-2		
1-230-08-2-2		
1-100-08-2-2		

**LIMAS PARA AFILADO**

Lima para cadena de motosierra, plana



ergo



**166-2**

		€		
150 mm	3	9,00	5	166-6-16-2.5-2

Lima para cadena de motosierra, plana



**166/167-12**

		€		
150 mm	3	4,39	12	166-6-16-2.5-12
200 mm	1	7,65	12	167-8-21-3.2-12

Lima para cadena de motosierra



**168 - 1P**

		€		
150 mm	3.2 mm	1,80	12	168-6-3.2-1P
150 mm	3.5 mm	1,80	12	168-6-3.5-1P
200 mm	4.0 mm	1,80	12	168-8-4.0-1P
200 mm	4.5 mm	1,80	12	168-8-4.5-1P
200 mm	4.8 mm	1,80	12	168-8-4.8-1P
200 mm	5.2 mm	1,80	12	168-8-5.2-1P
200 mm	5.5 mm	1,80	12	168-8-5.5-1P
200 mm	6.3 mm	2,07	12	168-8-6.3-1P

Lima para cadena de motosierra



**168 - 3P**

		€		
150 mm	3.2 mm	5,19	12	168-6-3.2-3P
150 mm	3.5 mm	5,19	12	168-6-3.5-3P
200 mm	4.0 mm	5,19	12	168-8-4.0-3P
200 mm	4.5 mm	5,19	12	168-8-4.5-3P
200 mm	4.8 mm	5,19	12	168-8-4.8-3P
200 mm	5.2 mm	5,19	12	168-8-5.2-3P
200 mm	5.5 mm	5,19	12	168-8-5.5-3P
200 mm	6.3 mm	5,19	12	168-8-6.3-3P

Lima para cadena de motosierra, caja de 6 limas



**168-8**

Longitud	Anchura	€	Caja	Artículo
200 mm	4.0 mm	1,76	6	168-8-4.0-6
200 mm	4.5 mm	1,76	6	168-8-4.5-6
200 mm	4.8 mm	1,76	6	168-8-4.8-6
200 mm	5.2 mm	1,77	6	168-8-5.2-6
200 mm	5.5 mm	1,76	6	168-8-5.5-6

Juego de limas para cadenas de motosierra con guía de limado



ergo®



**168-C-G**

Longitud	Anchura	€	Caja	Artículo
200 mm	4.0 mm	29,98	10	168-COMBI-4.0-6922
200 mm	4.8 mm	30,80	10	168-COMBI-4.8-6920
200 mm	5.5 mm	30,80	10	168-COMBI-5.5-6924

Juego de limas para cadenas de motosierra



ergo®



**168-C**

Longitud	Anchura	€	Caja	Artículo
200 mm	4.0 mm	15,47	10	168-COMBI-4.0
200 mm	4.5 mm	15,47	10	168-COMBI-4.5
200 mm	4.8 mm	15,47	10	168-COMBI-4.8
200 mm	5.5 mm	15,47	10	168-COMBI-5.5

Lima plana paralela



**4-138...-0**

Longitud	Cant.	€	Caja	Artículo
150 mm	1	7,83	10	4-138-06-1-0
200 mm	1	10,07	10	4-138-08-1-0
250 mm	1	12,40	10	4-138-10-1-0
300 mm	1	17,32	5	4-138-12-1-0

Lima plana paralela



ergo®



**4-138...-2**

Longitud	Cant.	€	Caja	Artículo
150 mm	1	11,11	5	4-138-06-1-2
200 mm	1	13,40	5	4-138-08-1-2
250 mm	1	15,54	5	4-138-10-1-2
300 mm	1	20,06	5	4-138-12-1-2

Lima plana paralela



ergo®



**4-140...-2**

Longitud	Cant.	€	Caja	Artículo
200 mm	1	13,40	5	4-140-08-1-2
250 mm	1	15,80	5	4-140-10-1-2

Lima plana paralela



**4-142**

Longitud	Cant.	€	Caja	Artículo
150 mm	1	7,55	10	4-142-06-1-0
200 mm	1	8,73	10	4-142-08-1-0
250 mm	1	11,42	10	4-142-10-1-0

Lima plana paralela



**4-144...-0**

Longitud	Cant.	€	Caja	Artículo
200 mm	2	10,56	10	4-144-08-2-0





Lima plana paralela



ergo®



**4-144...-2**

Icon	Icon	€	Icon	Icon
200 mm	2	13,79	5	4-144-08-2-2

Juego de 2 limas de bricolaje 4-152 + 4-153



ergo®



**4-154**

Icon	Icon	€	Icon	Icon
200 mm	1 & 2	32,12	10	4-154-08-2-2

Lima triangular para afilado



ergo®



**4-183...-2**

Icon	Icon	€	Icon	Icon
100 mm	2	6,38	5	4-183-04-2-2
125 mm	2	7,82	5	4-183-05-2-2
150 mm	2	8,01	5	4-183-06-2-2
175 mm	2	9,49	5	4-183-07-2-2
200 mm	2	11,29	5	4-183-08-2-2

Lima de bricolaje para madera



ergo®



**4-152**

Icon	Icon	€	Icon	Icon
200 mm	2 & 2	16,93	5	4-152-08-2-2

Un lado con picado doble basto, el otro lado picado sencillo entrefino

Lima para herramientas agrícolas



**4-155**

Icon	Icon	€	Icon	Icon
200 mm	1	12,59	10	4-155-08-2-0
250 mm	1	16,67	5	4-155-10-2-0

Lima triangular delgada



**4-186...-0**

Icon	Icon	€	Icon	Icon
100 mm	2	5,29	10	4-186-04-2-0
112 mm	2	5,29	10	4-186-45-2-0*
125 mm	2	5,29	10	4-186-05-2-0
150 mm	2	5,29	10	4-186-06-2-0
175 mm	2	7,49	10	4-186-07-2-0
200 mm	2	8,46	10	4-186-08-2-0

Lima de bricolaje para metal, embalaje individual



ergo®



**4-153**

Icon	Icon	€	Icon	Icon
200 mm	1 & 1	16,93	5	4-153-08-1-2

Un lado con picado doble basto, el otro lado picado sencillo entrefino

Lima triangular para afilado



**4-183...-0**

Icon	Icon	€	Icon	Icon
100 mm	2	4,53	10	4-183-04-2-0
125 mm	2	5,24	10	4-183-05-2-0
150 mm	2	6,24	10	4-183-06-2-0
175 mm	2	7,41	10	4-183-07-2-0
200 mm	2	9,87	10	4-183-08-2-0
250 mm	2	12,34	10	4-183-10-2-0

Lima triangular delgada



**4-186...-2**

Icon	Icon	€	Icon	Icon
100 mm	2	6,79	5	4-186-04-2-2
125 mm	2	7,54	5	4-186-05-2-2
150 mm	2	8,01	5	4-186-06-2-2

Lima triangular extra-delgada



**4-187...-0**

Longitud	Puntas	€	Paquete	Artículo
100 mm	2	5,59	10	4-187-04-2-0
112 mm	2	6,04	10	4-187-45-2-0*
125 mm	2	6,04	10	4-187-05-2-0
150 mm	2	6,39	10	4-187-06-2-0
175 mm	2	9,09	10	4-187-07-2-0

Lima triangular extra delgada



ergo®



**4-187...-2**

Longitud	Puntas	€	Paquete	Artículo
125 mm	2	8,17	5	4-187-05-2-2
150 mm	2	9,75	5	4-187-06-2-2

Lima triangular super delgada



**4-188...-0**

Longitud	Puntas	€	Paquete	Artículo
125 mm	2	7,33	10	4-188-05-2-0
150 mm	2	8,19	10	4-188-06-2-0

Lima triangular super delgada



ergo®



**4-188...-2**

Longitud	Puntas	€	Paquete	Artículo
125 mm	2	9,37	5	4-188-05-2-2

Lima triangular para sierras - 2 puntas



**4-190...-0**

Longitud	Puntas	€	Paquete	Artículo
175 mm	2	7,41	10	4-190-07-2-0
200 mm	2	7,91	10	4-190-08-2-0

Lima triangular para sierras - 2 puntas



ergo®



**4-190...-2**

Longitud	Puntas	€	Paquete	Artículo
150 mm	2	8,03	5	4-190-06-2-2
175 mm	2	9,66	5	4-190-07-2-2
200 mm	2	8,92	5	4-190-08-2-2

Lima triangular para sierra de cinta



**4-192...-0**

Longitud	Puntas	€	Paquete	Artículo
150 mm	2	8,66	10	4-192-06-2-0
175 mm	2	9,87	10	4-192-07-2-0
200 mm	2	10,56	10	4-192-08-2-0

Lima triangular para sierra de cinta



ergo®



**4-192...-2**

Longitud	Puntas	€	Paquete	Artículo
150 mm	2	11,99	5	4-192-06-2-2
200 mm	2	13,79	5	4-192-08-2-2

Limas para sierra de cinta



**4-202 - 4-204**

Longitud	Puntas	€	Paquete	Artículo
216 mm	2	10,78	10	4-202-85-2-0
216 mm	2	13,75	10	4-204-85-2-0

\* Hasta agotar existencias



Lima rómbica Wasa™



4-272...-0

Longitud	Picados	€	Paquetes	Referencia
150 mm	3	8,73	10	4-272-06-3-0

Escofina plana paralela



6-344...-2

Longitud	Picados	€	Paquetes	Referencia
200 mm	2	14,91	5	6-344-08-2-2
250 mm	2	18,13	5	6-344-10-2-2

Tipo de picado: 1-basto/ 2-entrefino

Escofina media caña, lengua de vaca



6-343...-0

Longitud	Picados	€	Paquetes	Referencia
200 mm	2	15,88	10	6-343-08-2-0
200 mm	3	18,13	10	6-343-08-3-0
250 mm	2	20,22	10	6-343-10-2-0
250 mm	3	23,15	10	6-343-10-3-0

Tipo de picado: 1 = Basto, 2 = Entrefino

Lima rómbica Wasa™



4-272...-2

Longitud	Picados	€	Paquetes	Referencia
125 mm	3	11,99	5	4-272-05-3-2
150 mm	3	11,99	5	4-272-06-3-2

Escofina media caña



6-342...-0

Longitud	Picados	€	Paquetes	Referencia
150 mm	2	8,93	10	6-342-06-2-0
200 mm	1	10,31	10	6-342-08-1-0
200 mm	2	11,99	10	6-342-08-2-0
250 mm	1	14,08	10	6-342-10-1-0
250 mm	2	15,19	10	6-342-10-2-0

Tipo de picado: 1 = Basto, 2 = Entrefino

Escofina media caña, lengua de vaca



6-343...-2

Longitud	Picados	€	Paquetes	Referencia
200 mm	2	18,49	5	6-343-08-2-2
250 mm	2	22,60	5	6-343-10-2-2

Tipo de picado: 1 = Basto, 2 = Entrefino

ESCOFINAS

Escofina plana paralela



6-344...-0

Longitud	Picados	€	Paquetes	Referencia
200 mm	2	10,78	10	6-344-08-2-0
250 mm	2	12,22	10	6-344-10-2-0

Tipo de picado: 1 = Basto, 2 = Entrefino

Escofina media caña



6-342...-2

Longitud	Picados	€	Paquetes	Referencia
150 mm	2	12,42	5	6-342-06-2-2
200 mm	1	13,94	5	6-342-08-1-2
200 mm	2	16,74	5	6-342-08-2-2
250 mm	1	17,30	5	6-342-10-1-2
250 mm	2	20,51	5	6-342-10-2-2

Tipo de picado: 1 = Basto, 2 = Entrefino

Escofina redonda



6-345...-0

Longitud	Picados	€	Paquetes	Referencia
200 mm	2	9,88	10	6-345-08-2-0
250 mm	2	11,95	10	6-345-10-2-0

Tipo de picado: 1 = Basto, 2 = Entrefino



## Escofina redonda



ergo



### 6-345...-2



Longitud	Picados	€	Paquete	Artículo
200 mm	1	11,24	5	6-345-08-1-2
200 mm	2	11,46	5	6-345-08-2-2
250 mm	1	14,22	5	6-345-10-1-2

Tipo de picado: 1 = Basto, 2 = Entrefino

## Juego de 3 escofinas ERGO™



ergo



### 6-470



Longitud	Picados	€	Paquete	Artículo
200 mm	2	55,07	5	6-470-08-2-2

6-345-08-2-2



6-342-08-2-2



4-152-08-2-2



## LIMAS CON DIENTES FRESADOS

### Hoja plana Pansar®



### 3-330



Longitud	Picados	€	Paquete	Artículo
300 mm	1	27,39	5	3-330-12-1-0
300 mm	2	29,24	5	3-330-12-2-0
350 mm	1	29,43	5	3-330-14-1-0
350 mm	2	33,78	5	3-330-14-2-0

Hoja 12" para portallimas 9-462 y 9-463, hoja 14" para portallimas 9-462

## Hoja de media caña Pansar®



### 3-331



Longitud	Picados	€	Paquete	Artículo
350 mm	1	29,98	5	3-331-14-1-0

Tipo de picado: 1 = Basto, 2 = Entrefino

## Lima patrón



ergo



### FM10



Longitud	Picados	€	Paquete	Artículo
300 mm	4 & 5	19,11	5	FM12
250 mm	4 & 5	19,11	5	FM10

Un lado con picado cizalla, por el otro dentado curvado

## Lima patrón, media caña



ergo



### HRFM10



Longitud	Picados	€	Paquete	Artículo
250 mm	5	23,33	5	HRFM10

## LIMAS DE AGUJA

### Lima plana paralela



### 2-300



Longitud	Picados	€	Paquete	Artículo
140 mm	0	7,96	10	2-300-14-0-0
140 mm	2	7,96	10	2-300-14-2-0
140 mm	4	8,39	10	2-300-14-4-0
160 mm	0	8,64	10	2-300-16-0-0
160 mm	1	8,64	10	2-300-16-1-0
160 mm	2	8,64	10	2-300-16-2-0
160 mm	4	9,17	10	2-300-16-4-0
180 mm	0	10,05	10	2-300-18-0-0
180 mm	2	10,05	10	2-300-18-2-0

Tipo de picado: 0 = Basto, 1 = Entrefino, 2 = Fino, 4 = Super-fino

### Lima plana



### 2-301



Longitud	Picados	€	Paquete	Artículo
140 mm	0	9,17	10	2-301-14-0-0
140 mm	2	9,17	10	2-301-14-2-0
160 mm	0	10,05	10	2-301-16-0-0
160 mm	1	10,05	10	2-301-16-1-0
160 mm	2	10,05	10	2-301-16-2-0

Tipo de picado: 0 = Basto, 1 = Entrefino, 2 = Fino, 4 = Super-fino

### Lima media caña



### 2-304



Longitud	Picados	€	Paquete	Artículo
140 mm	0	10,44	10	2-304-14-0-0
140 mm	2	10,44	10	2-304-14-2-0
140 mm	4	11,26	10	2-304-14-4-0
160 mm	0	11,52	10	2-304-16-0-0
160 mm	1	11,52	10	2-304-16-1-0
160 mm	2	11,52	10	2-304-16-2-0
160 mm	4	12,16	10	2-304-16-4-0
180 mm	0	13,31	10	2-304-18-0-0
180 mm	2	13,31	10	2-304-18-2-0

Tipo de picado: 0 = Basto, 1 = Entrefino, 2 = Fino, 4 = Super-fino



### Lima marking



#### 2-313

mm	0	€	10	2-313-16-0-0
160 mm	0	11,52	10	2-313-16-0-0

Tipo de picado: 0 = Basto, 1 = Entrefino, 2 = Fino, 4 = Super-fino

### Lima redonda



#### 2-307

mm	0	€	10	2-307-14-0-0
140 mm	0	7,96	10	2-307-14-0-0
140 mm	2	7,96	10	2-307-14-2-0
140 mm	4	8,39	10	2-307-14-4-0
160 mm	0	8,64	10	2-307-16-0-0
160 mm	1	8,64	10	2-307-16-1-0
160 mm	2	8,64	10	2-307-16-2-0
160 mm	4	9,17	10	2-307-16-4-0
180 mm	0	10,05	10	2-307-18-0-0
180 mm	2	10,05	10	2-307-18-2-0

Tipo de picado: 0 = Basto, 1 = Entrefino, 2 = Fino, 4 = Super-fino

### Lima ovalada



#### 2-305

mm	1	€	10	2-305-16-1-0
160 mm	1	11,52	10	2-305-16-1-0
160 mm	2	11,52	10	2-305-16-2-0

Tipo de picado: 0 = Basto, 1 = Entrefino, 2 = Fino, 4 = Super-fino

### Lima semi-ovalada



#### 2-306

mm	1	€	10	2-306-16-1-0
160 mm	1	11,52	10	2-306-16-1-0
160 mm	2	11,52	10	2-306-16-2-0

Tipo de picado: 0 = Basto, 1 = Entrefino, 2 = Fino, 4 = Super-fino

### Lima triangular



#### 2-302

mm	0	€	10	2-302-14-0-0
140 mm	0	9,17	10	2-302-14-0-0
140 mm	2	9,17	10	2-302-14-2-0
140 mm	4	9,56	10	2-302-14-4-0
160 mm	0	10,05	10	2-302-16-0-0
160 mm	1	10,05	10	2-302-16-1-0
160 mm	2	10,05	10	2-302-16-2-0
160 mm	4	10,44	10	2-302-16-4-0
180 mm	0	11,52	10	2-302-18-0-0
180 mm	2	11,52	10	2-302-18-2-0

Tipo de picado: 0 = Basto, 1 = Entrefino, 2 = Fino, 4 = Super-fino

### Lima Barrette



#### 2-309

mm	2	€	10	2-309-16-2-0
160 mm	2	10,05	10	2-309-16-2-0
160 mm	4	10,44	10	2-309-16-4-0

Tipo de picado: 0 = Basto, 1 = Entrefino, 2 = Fino, 4 = Super-fino

### Lima cuchillo



#### 2-308

mm	2	€	10	2-308-14-2-0
140 mm	2	10,44	10	2-308-14-2-0
160 mm	0	11,52	10	2-308-16-0-0
160 mm	1	11,52	10	2-308-16-1-0
160 mm	2	11,52	10	2-308-16-2-0

Tipo de picado: 0 = Basto, 1 = Entrefino, 2 = Fino, 4 = Super-fino

### Lima cuadrada



#### 2-303

mm	2	€	10	2-303-14-2-0
140 mm	2	9,17	10	2-303-14-2-0
160 mm	0	10,05	10	2-303-16-0-0
160 mm	1	10,05	10	2-303-16-1-0
160 mm	2	10,05	10	2-303-16-2-0
160 mm	4	10,44	10	2-303-16-4-0
180 mm	0	11,52	10	2-303-18-0-0
180 mm	2	11,52	10	2-303-18-2-0

Tipo de picado: 0 = Basto, 1 = Entrefino, 2 = Fino, 4 = Super-fino

### Juego de 6 limas de aguja + 1 mango



#### 2-470

mm	0	€	10	2-470-14-0-0
140 mm	0	49,36	10	2-470-14-0-0

#### 9-488-02-10

#### 2-304-14-0-0

#### 2-300-14-0-0

#### 2-303-14-0-0

#### 2-302-14-0-0

#### 2-301-14-0-0

#### 2-307-14-0-0

Juego de 6 limas de aguja + 1 mango



**2-470-14-2-0**

		€		
140 mm	2	48,15	10	2-470-14-2-0

9-488-02-10	
2-304-14-2-0	
2-300-14-2-0	
2-303-14-2-0	
2-302-14-2-0	
2-301-14-2-0	
2-307-14-2-0	

Juego de 6 limas de aguja + 1 mango



**2-470-14-4-0**

		€		
140 mm	4	52,56	10	2-470-14-4-0

9-488-02-10	
2-304-14-4-0	
2-300-14-4-0	
2-303-14-4-0, 2-301-14-4-0	
2-302-14-4-0	
2-307-14-4-0	

Juego de 6 limas de aguja + 1 mango



**2-470-16-1-0**

		€		
160 mm	1	50,69	10	2-470-16-1-0

9-488-02-10	
2-304-16-1-0	
2-300-16-1-0	
2-303-16-1-0	
2-302-16-1-0	
2-301-16-1-0	
2-307-16-1-0	

Juego de 6 limas de aguja + 1 mango



**2-470-16-2-0**

		€		
160 mm	2	52,27	10	2-470-16-2-0

9-488-02-10	
2-304-16-2-0	
2-300-16-2-0	
2-303-16-2-0	
2-302-16-2-0	
2-301-16-2-0	
2-307-16-2-0	

Juego de 9 limas de aguja + 1 mango



**2-471**

		€		
160 mm	1	86,03	5	2-471-16-1-0

9-488-02-10	
2-303-16-1-0	
2-304-16-1-0	
2-302-16-1-0	
2-300-16-1-0	
2-308-16-1-0	
2-301-16-1-0	
2-306-16-1-0	
2-305-16-1-0	
2-307-16-1-0	

Juego de 12 limas de aguja + 1 mango



**2-472**

		€		
140 mm	0	93,94	5	2-472-14-0-0

2-303-14-0-0, 2-313-14-0-0, 2-309-14-0-0, 2-306-14-0-0	
2-300-14-0-0	
2-301-14-0-0	
2-304-14-0-0	
2-302-14-0-0	
2-307-14-0-0	
9-488-02-10	



Juego de 12 limas de aguja



**2-472-14-2-0**

		€		
140 mm	2	93,94	5	2-472-14-2-0

2-303-14-2-0	
2-300-14-2-0	
2-301-14-2-0	
2-304-14-2-0	
2-302-14-2-0	
2-313-14-2-0, 2-306-14-2-0	
2-307-14-2-0	
2-308-14-2-0	
9-488-02-10	

Juego de 12 limas de aguja



**2-472-16-0-0**

		€		
160 mm	0	101,37	5	2-472-16-0-0

2-303-16-0-0	
2-300-16-0-0	
2-301-16-0-0	
2-304-16-0-0	
2-302-16-0-0	
2-313-16-0-0	
2-307-16-0-0	
2-306-16-0-0	
2-308-16-0-0	
9-488-02-10	

Juego de 12 limas de aguja



**2-472-16-1-0**

		€		
160 mm	1	101,37	5	2-472-16-1-0

2-300-16-1-0	
2-301-16-1-0	
2-302-16-1-0	
2-303-16-1-0	
2-304-16-1-0	
2-306-16-1-0	
2-307-16-1-0	
2-308-16-1-0	
2-309-16-2-0	
2-311-16-2-0	
2-313-16-2-0	
9-488-02-10	

Juego de 12 limas de aguja



**2-472-16-2-0**

		€		
160 mm	2	101,37	5	2-472-16-2-0

2-303-16-2-0	
2-300-16-2-0	
2-301-16-2-0	
2-311-16-2-0	
2-304-16-2-0	
2-302-16-2-0	
2-313-16-2-0	
2-307-16-2-0	
2-309-16-2-0	
2-306-16-2-0	
2-308-16-2-0	
9-488-02-10	

**LIMAS DE DIAMANTE**

Limas de aguja de diamante



**2-300-D - 2-304-D**

	€		
140 mm	55,51	10	2-300-14-D-1P
160 mm	74,48	10	2-300-16-D-1P
140 mm	55,51	1	2-301-14-D-1P
140 mm	61,08	10	2-302-14-D-1P
160 mm	81,68	10	2-302-16-D-1P
140 mm	55,51	10	2-303-14-D-1P
160 mm	74,48	1	2-303-16-D-1P
140 mm	61,08	10	2-304-14-D-1P
160 mm	81,68	10	2-304-16-D-1P

Limas de aguja de diamante



**2-306-D - 2-308-D**

	€		
140 mm	61,08	1	2-306-14-D-1P
140 mm	55,51	10	2-307-14-D-1P
160 mm	74,48	10	2-307-16-D-1P
140 mm	61,08	1	2-308-14-D-1P

Limas de precisión de diamante



**5-600-D - 5-670-D**

	€		
215 mm	141,07	10	5-600-21-D-1P
215 mm	139,96	5	5-610-21-D-1P
215 mm	99,94	1	5-630-21-D-1P
215 mm	148,40	1	5-670-21-D-1P*

## ACCESORIOS

Portalimas Pansar®



**9-462**

	€		
350 mm	58,53	5	9-462-14-0-0*

Mango universal para limas de aguja



**9-488-02**

	€		
5 g	2,62	10	9-488-02-10

Mango para limas de cadenas de motosierra



**PH-6604**

	€		
55 g	3,20	15	PH-6604-1P
50 g	2,05	25	PH-6604-25

Cepillo para limas



**9-467**

		€		
130 mm	260 mm	44,54	1	9-467-00-0-0

Cepillo para limas



**9-469**

		€		
110 mm	240 mm	16,95	1	9-469-00-0-0

Mango bimataterial ERGO™ para limas pequeñas



ergo



**9-484...10**

		€		
3.2	3.2 mm	1,83	10	9-484-3.2-10
5.2	5.2 mm	1,83	10	9-484-5.2-10

Mango bimataterial ERGO™ para limas pequeñas



ergo



**9-484...1P**

		€		
3.2	3.2 mm	3,16	10	9-484-3.2-1P
5.2	5.2 mm	3,16	10	9-484-5.2-1P

Mango bimataterial ERGO™ para limas planas



ergo



**9-485...10**

		€		
4	4 mm	3,16	10	9-485-04-10
5	5 mm	3,16	10	9-485-05-10
6	6 mm	3,44	10	9-485-06-10
9	9 mm	3,44	10	9-485-09-10
13	13 mm	3,44	10	9-485-13-10

Mango bimataterial ERGO™ para limas planas



ergo



**9-485...1P**

		€		
4	4 mm	3,16	10	9-485-04-1P
5	5 mm	3,16	10	9-485-05-1P
6	6 mm	4,64	20	9-485-06-1P
9	9 mm	4,64	20	9-485-09-1P
13	13 mm	4,64	1	9-485-13-1P

Para limas planas, punta sin mango y semiesféricas

\* Hasta agotar existencias



Mango bimaterial ERGO™ para limas



ergo®



**9-486-C-10**

		€		
3.2	3.2 mm	3,29	10	9-486-C-10

Mango bimaterial ERGO™ para limas



ergo®



**9-486...10**

		€		
4	4 mm	3,44	10	9-486-04-10
5	5 mm	3,44	10	9-486-05-10
7	7 mm	3,45	10	9-486-07-10
8	8 mm	4,62	10	9-486-08-10

Mango bimaterial ERGO™ para limas



ergo®



**9-486-C-1P**

		€		
3.2	3.2 mm	4,39	10	9-486-C-1P

Mango bimaterial ERGO™ para limas



ergo®



**9-486...1P**

		€		
4	4 mm	4,64	20	9-486-04-1P
5	5 mm	4,64	20	9-486-05-1P
7	7 mm	4,64	20	9-486-07-1P





# Llaves



## LLAVES AJUSTABLES "INGLESAS"

Llave ajustable pavonada

ergo



90

L	Icon	€	Icon	Icon
158mm/6"	20 mm	29,98	5	9070
208mm/8"	27 mm	32,56	5	9071
257mm/10"	31 mm	42,39	5	9072
308mm/12"	34 mm	61,66	5	9073

Llave ajustable fosfatada moleta central ERGO™, con mordaza reversible

ergo



90P

L	Icon	€	Icon	Icon
158mm/6"	21 mm	33,57	5	9070 P
208mm/8"	28 mm	35,83	5	9071 P
257mm/10"	33 mm	45,95	5	9072 P
308mm/12"	35 mm	65,23	5	9073 P

Llave ajustable cromada plateada

ergo



90C

L	Icon	€	Icon	Icon
158mm/6"	20 mm	27,15	5	9070C
208mm/8"	27 mm	29,08	5	9071C
257mm/10"	31 mm	37,45	5	9072 C
308mm/12"	34 mm	54,67	3	9073 C

Llave ajustable cromada moleta central ERGO™, con mordaza reversible

ergo



90PC

L	Icon	€	Icon	Icon
158mm/6"	21 mm	29,92	5	9070 PC
208mm/8"	28 mm	32,04	5	9071 PC
257mm/10"	33 mm	40,23	5	9072 PC
308mm/12"	35 mm	57,44	3	9073 PC

Llave ajustable pavonada, gran apertura

ergo



9029-9035

L	Icon	€	Icon	Icon
170mm/6"	32 mm	31,44	5	9029
218mm/8"	38 mm	34,17	5	9031
270mm/10"	46 mm	44,57	5	9033
324mm/12"	55 mm	64,60	5	9035

Llave ajustable especial

ergo



9029C/9031C

L	Icon	€	Icon	Icon
170mm/6"	32 mm	36,85	5	9029 C
218mm/8"	38 mm	39,52	5	9031 C

Llave ajustable, gran apertura, mordazas extra finas

ergo



9029-T/9031-T

L	Icon	€	Icon	Icon
170mm/6"	32 mm	36,26	5	9029-T
218mm/8"	38 mm	42,19	5	9031-T

Llave ajustable, gran apertura y mordazas reversibles

ergo



9031P

L	Icon	€	Icon	Icon
218mm/8"	39 mm	37,02	5	9031P

Juego 3 ajustables serie 90 con mango termoplástico (6", 8" y 10")

ergo



ADJUST3-90

g	€	Icon	Icon
900 g	93,84	1	ADJUST 3-90

9070, 9071, 9072



## Juego de llaves 9031 & 9029



ergo



### ADJUST9031/29

g	€		
550 g	65,62	3	ADJUST 9031/29

9029, 9031



## Llave ajustable, fosfatada



### 80

L		€		
110mm/4"	13 mm	23,00	5	8069
155mm/6"	20 mm	24,15	5	8070
205mm/8"	27 mm	26,20	5	8071
255mm/10"	31 mm	34,15	5	8072
305mm/12"	34 mm	49,64	5	8073
380mm/15"	44 mm	81,11	3	8074
455mm/18"	53 mm	127,45	3	8075
110mm/4"	13 mm	22,27	50	8069 IP
155mm/6"	20 mm	23,49	40	8070 IP
205mm/8"	27 mm	25,54	50	8071 IP
255mm/10"	31 mm	33,49	30	8072 IP
305mm/12"	34 mm	48,98	20	8073 IP
380mm/15"	44 mm	80,46	20	8074 IP
455mm/18"	53 mm	126,77	10	8075 IP

## Llave ajustable moleta central, cromada



### 80C

L		€		
110mm/4"	13 mm	16,89	5	8069 C
155mm/6"	20 mm	17,33	5	8070 C
205mm/8"	27 mm	19,70	5	8071 C
255mm/10"	31 mm	23,90	5	8072 C
305mm/12"	34 mm	31,46	5	8073 C
380mm/15"	44 mm	52,85	3	8074 C
455mm/18"	53 mm	82,00	3	8075 C
110mm/4"	13 mm	16,38	5	8069 C IP

L		€		
155mm/6"	20 mm	16,80	5	8070 C IP
205mm/8"	27 mm	19,21	5	8071 C IP
255mm/10"	31 mm	23,39	5	8072 C IP
305mm/12"	34 mm	30,94	5	8073 C IP
380mm/15"	44 mm	52,32	3	8074 C IP
455mm/18"	53 mm	81,50	3	8075 C IP

IP: Embalaje industrial

## Llave ajustable gran tamaño



### 86/87

L		€		
614mm/24"	63 mm	285,33	1	86
770mm/30"	85 mm	291,37	1	87

## Juego 3 llaves ajustables serie 80 (6", 8" y 10")



### ADJUST3

g	€		
810 g	79,91	1	ADJUST 3

8070, 8071, 8072

## Repuestos para llaves ajustables



### RPS

	€		
8069, 8069 C	5,03	1	8069-1
8070, 8070 C, 9070, 9070 C	5,82	1	8070-1
8071, 8071 C, 9071, 9071 C	5,40	1	8071-1

	€		
8072, 8072 C, 9072, 9072 C	5,60	1	8072-1
8073, 8073 C, 9073, 9073 C	6,47	1	8073-1
8074, 8074 C	10,51	1	8074-1
8075, 8075 C	13,94	1	8075-1
9029, 9029 C, 31	6,17	1	9029-1
9029-T	13,75	1	9029T-1
9031, 9031 C	5,97	1	9031-1
9031-T	13,86	1	9031T-1
9033, 33H	13,04	1	9033-1
9035	14,57	1	9035-1
86	8,30	1	86-1
87	10,42	1	87-1
9031 P	8,65	1	9031 P-1
9070 P, 9070 PC	8,40	1	9070 P-1
9071 P, 9071 PC	8,21	1	9071 P-1
9072 P, 9072 PC	9,03	1	9072 P-1
9073 P, 9073 PC	10,25	1	9073 P-1

-1: mordaza -2: tornillo y muelle

## Moleta, pasador y muelle de repuesto para llaves ajustables "inglesas" con moleta central



### RPS2

	g	€		
8069, 8069 C	3 g	3,06	1	8069-2
8070, 8070 C, 9070, 9070 C, 9070 P, 9070 PC	8 g	3,19	1	8070-2
8071, 8071 C, 9071, 9071 C, 9071 P, 9071 PC	10 g	3,22	1	8071-2
8072, 8072 C, 9072, 9072 C, 9072 P, 9072 PC	16 g	3,53	1	8072-2
8073, 8073 C, 9073, 9073 C, 9073 P, 9073 PC, 9033	25 g	3,88	1	8073-2
8074, 8074 C, 9035	47 g	4,56	1	8074-2
8075, 8075 C	54 g	5,10	1	8075-2
9029, 9029 C, 9029-T, 9031-T, 31, 9031, 9031 C, 9031P	9 g	3,53	1	9029-2
86	125 g	6,98	1	86-2
87	185 g	7,32	1	87-2



Llave ajustable podger, serie larga



**84**

		€		
405mm/16"	41 mm	38,22	1	84-PODGER

Llave ajustable para volantes de válvulas



**33H**

		€		
254mm/10"	46 mm	68,37	5	33H

Llave ajustable función tubo



**31**

		€		
209mm/8"	32 mm	38,37	5	31
209mm/8"	32 mm	36,95	50	31-IP

Llave ajustable "inglesa" con mordazas finas y acabado fosfatado



**31-T**

		€		
209mm/8"	32 mm	36,95	5	31-T
209mm/8"	32 mm	36,95	50	31-T-IP

Llave ajustable fosfatada, Industria pesada



**95**

		€		
257mm/10"	35 mm	49,64	5	9572*

Llave ajustable de moleta lateral, cromada



**91C/97C**

		€		
155mm/6"	21 mm	28,22	5	91C
205mm/8"	29 mm	32,18	5	92C
255mm/10"	34 mm	38,18	5	93C
305mm/12"	39 mm	48,79	5	94C
405mm/16"	48 mm	81,66	1	95C
500mm/20"	60 mm	155,21	1	96C
750mm/30"	77 mm	303,27	1	97C

## LLAVES COMBINADAS

Llaves combinadas, mm



**111M**

	€		
5.5 mm	6,58	10	111M-5.5
6 mm	5,98	10	111M-6
7 mm	6,05	10	111M-7
8 mm	6,22	10	111M-8
9 mm	7,43	10	111M-9
10 mm	7,48	10	111M-10
11 mm	8,13	10	111M-11
12 mm	8,58	10	111M-12
13 mm	9,03	10	111M-13
14 mm	9,40	10	111M-14
15 mm	9,74	10	111M-15
16 mm	10,30	10	111M-16
17 mm	11,01	10	111M-17
18 mm	11,61	10	111M-18
19 mm	13,27	10	111M-19
20 mm	13,42	10	111M-20
21 mm	15,34	10	111M-21
22 mm	15,47	5	111M-22
23 mm	16,38	5	111M-23
24 mm	17,13	5	111M-24
25 mm	18,58	5	111M-25
26 mm	22,05	5	111M-26
27 mm	24,26	5	111M-27
28 mm	25,91	5	111M-28
29 mm	26,56	5	111M-29
30 mm	29,55	5	111M-30
32 mm	31,85	5	111M-32
33 mm	34,26	5	111M-33
34 mm	36,86	5	111M-34
36 mm	52,10	1	111M-36
38 mm	61,61	1	111M-38
41 mm	66,15	1	111M-41
46 mm	87,23	1	111M-46
50 mm	98,80	1	111M-50
55 mm	172,28	1	111M-55
60 mm	228,55	1	111M-60
65 mm	304,35	1	111M-65
70 mm	361,78	1	111M-70
75 mm	455,95	1	111M-75
80 mm	526,01	1	111M-80
85 mm	707,62	1	111M-85
90 mm	716,11	1	111M-90
95 mm	718,23	1	111M-95
100 mm	737,33	1	111M-100
5.5 mm	7,00	1	SB111M-5,5
6 mm	7,26	1	SB111M-6
7 mm	7,31	1	SB111M-7
8 mm	7,49	1	SB111M-8
9 mm	8,74	1	SB111M-9
10 mm	8,81	1	SB111M-10
11 mm	9,48	1	SB111M-11
12 mm	9,93	1	SB111M-12
13 mm	10,41	1	SB111M-13
14 mm	10,83	1	SB111M-14
15 mm	11,15	1	SB111M-15

	€		
16 mm	11,99	1	SB111M-16
17 mm	12,50	1	SB111M-17
18 mm	13,09	1	SB111M-18
19 mm	14,84	1	SB111M-19
20 mm	14,96	1	SB111M-20
21 mm	16,98	1	SB111M-21
22 mm	17,11	1	SB111M-22
23 mm	18,07	1	SB111M-23
24 mm	18,87	1	SB111M-24
25 mm	20,36	1	SB111M-25
26 mm	19,83	1	SB111M-26
27 mm	22,20	1	SB111M-27
28 mm	27,38	1	SB111M-28
29 mm	29,65	1	SB111M-29
30 mm	31,75	1	SB111M-30
32 mm	35,34	1	SB111M-32

SB- Presentación para colgar

### Llave combinada, pulgadas



### 111Z

	€		
1/4 in	6,25	5	111Z-1/4
5/16 in	6,46	5	111Z-5/16
3/8 in	7,85	5	111Z-3/8
7/16 in	8,55	5	111Z-7/16
1/2 in	9,46	5	111Z-1/2
9/16 in	9,96	5	111Z-9/16
5/8 in	10,80	5	111Z-5/8
11/16 in	11,43	5	111Z-11/16
3/4 in	13,69	5	111Z-3/4
13/16 in	15,91	5	111Z-13/16
7/8 in	16,18	5	111Z-7/8
15/16 in	18,02	3	111Z-15/16
1 in	19,47	3	111Z-1
1 1/16 in	25,25	5	111Z-1.1/16
1 1/8 in	26,98	5	111Z-1.1/8
1 1/4 in	33,01	5	111Z-1.1/4
1 5/16 in	38,42	5	111Z-1.5/16
1 3/8 in	54,09	1	111Z-1.3/8
1 7/16 in	54,09	1	111Z-1.7/16
1 1/2 in	56,83	1	111Z-1.1/2
1 5/8 in	68,68	1	111Z-1.5/8
1 11/16 in	88,70	1	111Z-1.11/16
1 3/4 in	95,17	1	111Z-1.3/4
1 13/16 in	88,52	1	111Z-1.13/16
1 7/8 in	101,23	1	111Z-1.7/8
2 in	102,61	1	111Z-2
2 1/8 in	180,51	1	111Z-2.1/8
2 1/4 in	180,51	1	111Z-2.1/4
2 3/8 in	249,48	1	111Z-2.3/8
2 1/2 in	309,19	1	111Z-2.1/2
2 5/8 in	309,19	1	111Z-2.5/8
2 3/4 in	328,87	1	111Z-2.3/4
2 7/8 in	399,16	1	111Z-2.7/8
3 in	399,16	1	111Z-3

### Llave combinada stubby, pulgadas



### 1Z

	€		
3/16 in	7,68	20	1Z-3/16
7/32 in	7,68	20	1Z-7/32*
9/32 in	7,40	20	1Z-9/32
5/16 in	4,78	10	1Z-5/16
11/32 in	5,49	10	1Z-11/32*
3/8 in	5,49	10	1Z-3/8
7/16 in	5,87	10	1Z-7/16
1/2 in	6,49	10	1Z-1/2
9/16 in	6,87	10	1Z-9/16
5/8 in	7,77	10	1Z-5/8
11/16 in	8,04	10	1Z-11/16
3/4 in	9,28	10	1Z-3/4
13/16 in	10,74	10	1Z-13/16
7/8 in	10,74	10	1Z-7/8
15/16 in	17,09	5	1Z-15/16
1 in	17,33	10	1Z-1

### Llave combinada, mm



### S20

	€		
7	5,67	1	SBS20-7*
8	5,87	1	SBS20-8*
9	6,00	1	SBS20-9*
11	6,50	1	SBS20-11*
12	7,13	1	SBS20-12*
13	7,16	1	SBS20-13*
14	7,85	1	SBS20-14*
15	8,06	1	SBS20-15*
16	8,63	1	SBS20-16
18	8,65	1	SBS20-18*
20	11,89	1	SBS20-20*
21	12,46	1	SBS20-21*
22	13,68	1	SBS20-22*

### Juego de 5 llaves combinadas, mm



### 111M/SH5

	€		
5	47,01	1	111M/SH5

111M-8, 111M-10, 111M-13, 111M-17, 111M-19

### Juego de 8 llaves combinadas, mm



### 111M/SH8

	€		
8	86,79	1	111M/SH8

111M-8, 111M-10, 111M-12, 111M-13, 111M-14, 111M-17, 111M-19, 111M-22

### Juego de 12 llaves combinadas, mm



### 111M/SH12

	€		
12	123,62	1	111M/SH12

111M-8, 111M-9, 111M-10, 111M-11, 111M-12, 111M-13, 111M-14, 111M-15, 111M-16, 111M-17, 111M-18, 111M-19

\* Hasta agotar existencias



Juego de 10 llaves combinadas, mm



**111M/**



€



10 97,45 1 111M/S10

111M-8, 111M-9, 111M-10, 111M-11, 111M-12, 111M-13, 111M-14, 111M-17, 111M-19, 111M-22



Juego de 11 llaves combinadas, mm



**111M/11T**



€



11 111,12 1 111M/11T

111M-8, 111M-9, 111M-10, 111M-11, 111M-12, 111M-13, 111M-14, 111M-15, 111M-17, 111M-19, 111M-22



Juego de 14 llaves combinadas, mm



**111M/14T**



€



14 204,98 1 111M/14T

111M-6, 111M-8, 111M-9, 111M-10, 111M-13, 111M-14, 111M-15, 111M-17, 111M-19, 111M-22, 111M-24, 111M-27, 111M-30, 111M-32



Juego de 17 llaves combinadas, mm



**111M/17T**



€



17 177,40 1 111M/17T

111M-6, 111M-7, 111M-8, 111M-9, 111M-10, 111M-11, 111M-12, 111M-13, 111M-14, 111M-15, 111M-16, 111M-17, 111M-18, 111M-19, 111M-20, 111M-21, 111M-22



Juego de 17 llaves combinadas, mm



**111M/17TL**



€



17 228,36 1 111M/17TL

111M-8, 111M-9, 111M-10, 111M-11, 111M-12, 111M-13, 111M-14, 111M-15, 111M-16, 111M-18, 111M-19, 111M-22, 111M-24, 111M-26, 111M-27, 111M-30, 111M-32



Juego de 24 llaves combinadas, mm



**111M/24T**



€



24 375,14 1 111M/24T

111M-6, 111M-7, 111M-8, 111M-9, 111M-10, 111M-11, 111M-12, 111M-13, 111M-14, 111M-15, 111M-16, 111M-17, 111M-18, 111M-19, 111M-20, 111M-21, 111M-22, 111M-24, 111M-26, 111M-27, 111M-28, 111M-30, 111M-32, 111M-36



Juego de 26 llaves combinadas, mm



**111M/26T**



€



26 392,04 1 111M/26T

111M-6, 111M-7, 111M-8, 111M-9, 111M-10, 111M-11, 111M-12, 111M-13, 111M-14, 111M-15, 111M-16, 111M-17, 111M-18, 111M-19, 111M-20, 111M-21, 111M-22, 111M-23, 111M-24, 111M-25, 111M-26, 111M-27, 111M-28, 111M-29, 111M-30, 111M-32



Juegos de 8 llaves combinadas, pulgadas



**111Z/**



€



8 98,74 1 111Z/8T



111Z-3/8, 111Z-7/16, 111Z-1/2, 111Z-9/16, 111Z-5/8, 111Z-11/16, 111Z-3/4, 111Z-7/8



Juegos de 11 llaves combinadas, pulgadas



111Z/11T

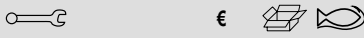

11	158,39	1	111Z/11T
----	--------	---	----------

111Z-3/8, 111Z-7/16, 111Z-1/2, 111Z-9/16, 111Z-5/8, 111Z-11/16, 111Z-3/4, 111Z-13/16, 111Z-7/8, 111Z-15/16, 111Z-1



Llave combinada extra larga, mm



11M

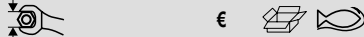

	€		
8 mm	11,76	5	11M-8
9 mm	11,76	5	11M-9
10 mm	12,36	5	11M-10
11 mm	12,36	5	11M-11
12 mm	14,14	5	11M-12
13 mm	14,14	5	11M-13
14 mm	17,07	5	11M-14
15 mm	17,07	5	11M-15
16 mm	18,73	5	11M-16
17 mm	19,32	5	11M-17
18 mm	19,46	5	11M-18
19 mm	24,46	5	11M-19
21 mm	24,46	5	11M-21
22 mm	18,34	5	11M-22
24 mm	31,33	5	11M-24
27 mm	40,63	1	11M-27
30 mm	49,16	1	11M-30
32 mm	49,16	1	11M-32
36 mm	63,20	1	11M-36
38 mm	66,97	1	11M-38

Llave combinada acodada extra larga, pulgadas



11Z

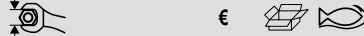

	€		
3/8 in	11,75	5	11Z-3/8*
7/16 in	12,15	5	11Z-7/16*
1/2 in	12,51	5	11Z-1/2*
9/16 in	12,96	5	11Z-9/16*
5/8 in	15,50	5	11Z-5/8*
11/16 in	15,50	5	11Z-11/16*
3/4 in	17,36	5	11Z-3/4*
13/16 in	18,19	5	11Z-13/16*
1 in	38,53	5	11Z-1*

Llave combinada Liliput, mm



4020L-M

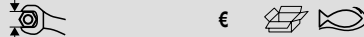

	€		
3.2 mm	20,18	5	4020L-M-3.2
3.5 mm	20,18	5	4020L-M-3.5
4 mm	19,06	5	4020L-M-4
4.5 mm	19,06	5	4020L-M-4.5
5 mm	19,06	5	4020L-M-5
5.5 mm	19,06	5	4020L-M-5.5

Llaves combinadas acodadas, mm



1952M

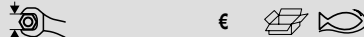

	€		
6 mm	9,46	10	1952M-6
7 mm	9,46	10	1952M-7
8 mm	9,34	10	1952M-8
9 mm	10,51	10	1952M-9
10 mm	10,51	10	1952M-10
11 mm	11,27	10	1952M-11
12 mm	11,91	10	1952M-12
13 mm	12,91	10	1952M-13
14 mm	13,02	10	1952M-14
15 mm	15,41	10	1952M-15

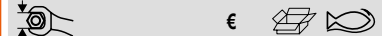

	€		
16 mm	16,67	10	1952M-16
17 mm	17,22	10	1952M-17
18 mm	19,27	10	1952M-18
19 mm	20,20	10	1952M-19
20 mm	21,39	10	1952M-20
21 mm	22,23	10	1952M-21
22 mm	24,93	5	1952M-22
23 mm	26,92	5	1952M-23
24 mm	28,14	5	1952M-24
25 mm	30,03	5	1952M-25
26 mm	30,32	5	1952M-26
27 mm	32,33	5	1952M-27
28 mm	36,86	1	1952M-28
29 mm	39,35	1	1952M-29
30 mm	41,31	1	1952M-30
32 mm	43,20	1	1952M-32
34 mm	55,99	1	1952M-34
36 mm	73,40	1	1952M-36
41 mm	91,25	1	1952M-41
46 mm	146,81	1	1952M-46
50 mm	186,62	1	1952M-50
55 mm	238,31	1	1952M-55
60 mm	362,92	1	1952M-60
65 mm	463,81	1	1952M-65
70 mm	500,80	1	1952M-70
75 mm	567,50	1	1952M-75
80 mm	680,41	1	1952M-80
7 mm	10,67	1	SB1952M-7
8 mm	10,52	1	SB1952M-8
10 mm	11,71	1	SB1952M-10
12 mm	13,10	1	SB1952M-12
13 mm	14,10	1	SB1952M-13
14 mm	14,22	1	SB1952M-14
17 mm	18,41	1	SB1952M-17
19 mm	21,39	1	SB1952M-19
24 mm	29,33	1	SB1952M-24

Llave combinada acodada, pulgadas



1952Z

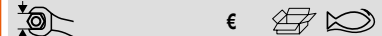

	€		
1/4 in	9,97	5	1952Z-1/4
5/16 in	10,12	5	1952Z-5/16
11/32 in	10,76	5	1952Z-11/32
3/8 in	11,31	5	1952Z-3/8
7/16 in	12,28	5	1952Z-7/16
1/2 in	20,04	5	1952Z-1/2
9/16 in	14,95	5	1952Z-9/16
5/8 in	16,97	5	1952Z-5/8
11/16 in	20,00	5	1952Z-11/16
3/4 in	21,87	5	1952Z-3/4
13/16 in	23,39	5	1952Z-13/16
7/8 in	28,07	5	1952Z-7/8
15/16 in	29,90	5	1952Z-15/16
1 in	31,11	1	1952Z-1
1 1/16 in	34,20	1	1952Z-1.1/16
1 1/8 in	40,38	1	1952Z-1.1/8
1 1/4 in	46,37	1	1952Z-1.1/4
1 5/16 in	50,07	1	1952Z-1.5/16
1 3/8 in	90,93	1	1952Z-1.3/8
1 7/16 in	96,41	1	1952Z-1.7/16
1 1/2 in	97,38	1	1952Z-1.1/2
1 5/8 in	116,72	1	1952Z-1.5/8

\* Hasta agotar existencias



Llave combinada acodada, mm



**PU**

mm	€	Icon	Icon
6 mm	7,52	5	PU-6*
7 mm	9,67	5	PU-7*
8 mm	8,58	5	PU-8
9 mm	9,11	5	PU-9*
14 mm	11,24	5	PU-14*
20 mm	16,54	3	PU-20*
21 mm	16,54	3	PU-21*
22 mm	22,15	3	PU-22*
23 mm	23,69	3	PU-23*
24 mm	25,21	3	PU-24*
25 mm	31,94	1	PU-25*
26 mm	32,29	1	PU-26*
27 mm	36,50	1	PU-27*
28 mm	40,03	1	PU-28*
29 mm	40,53	1	PU-29*
30 mm	43,69	1	PU-30*
32 mm	44,91	1	PU-32*
36 mm	58,33	1	PU-36*

Producto no disponible para España

Juego de 6 llaves combinadas acodadas, mm



**1952M/SH**

Icon	€	Icon	Icon
6	81,81	1	1952M/SH6

1952M-8, 1952M-10, 1952M-12, 1952M-13, 1952M-14, 1952M-17

Juego de 12 llaves combinadas acodadas, mm



**1952M/SH12**

Icon	€	Icon	Icon
12	182,02	1	1952M/SH12

1952M-8, 1952M-9, 1952M-10, 1952M-11, 1952M-12, 1952M-13, 1952M-14, 1952M-15, 1952M-16, 1952M-17, 1952M-18, 1952M-19

Juego de 10 llaves combinadas, acodadas, mm



**1952M/**

Icon	€	Icon	Icon
10	132,30	1	1952M/10

1952M-8, 1952M-9, 1952M-10, 1952M-11, 1952M-12, 1952M-13, 1952M-14, 1952M-16, 1952M-17, 1952M-19

Juegos de 7 llaves combinadas acodadas, mm



**1952M/T**

Icon	€	Icon	Icon
7	112,40	1	1952M/7T

1952M-8, 1952M-10, 1952M-13, 1952M-14, 1952M-17, 1952M-19, 1952M-22

Juego de 14 llaves combinadas acodadas, mm



**1952M/14T**

Icon	€	Icon	Icon
14	295,37	1	1952M/14T

1952M-6, 1952M-8, 1952M-9, 1952M-10, 1952M-13, 1952M-14, 1952M-15, 1952M-17, 1952M-19, 1952M-22, 1952M-24, 1952M-27, 1952M-30, 1952M-32

Juego de 17 llaves combinadas, acodadas, mm



**1952M/17T**

Icon	€	Icon	Icon
17	266,45	1	1952M/17T

1952M-6, 1952M-7, 1952M-8, 1952M-9, 1952M-10, 1952M-11, 1952M-12, 1952M-13, 1952M-14, 1952M-15, 1952M-16, 1952M-17, 1952M-18, 1952M-19, 1952M-20, 1952M-21, 1952M-22

Juego de 26 llaves combinadas, acodadas, mm



**1952M/26T**

Icon	€	Icon	Icon
26	574,10	1	1952M/26T



1952M-6, 1952M-7, 1952M-8, 1952M-9, 1952M-10, 1952M-11, 1952M-12, 1952M-13, 1952M-14, 1952M-15, 1952M-16, 1952M-17, 1952M-18, 1952M-19, 1952M-20, 1952M-21, 1952M-22, 1952M-23, 1952M-24, 1952M-25, 1952M-26, 1952M-27, 1952M-28, 1952M-29, 1952M-30, 1952M-32

Juego de 11 llaves combinadas acodadas, pulgadas



### 1952Z/T

Icon	€	Icon	Icon
11	185,30	1	1952Z/11T

1952Z-1/4, 1952Z-5/16, 1952Z-3/8, 1952Z-7/16, 1952Z-1/2, 1952Z-9/16, 1952Z-5/8, 1952Z-11/16, 1952Z-3/4, 1952Z-13/16, 1952Z-7/8

## LLAVES DE CARRACA

Llave combinada de carraca reversible, mm



### 1RM

Icon	€	Icon	Icon
6 mm	23,23	60	1RM-6
7 mm	23,23	60	1RM-7
8 mm	24,53	60	1RM-8
9 mm	24,84	60	1RM-9
10 mm	26,52	60	1RM-10
11 mm	28,15	60	1RM-11
12 mm	30,23	60	1RM-12
13 mm	31,31	60	1RM-13

Icon	€	Icon	Icon
14 mm	32,67	30	1RM-14
15 mm	33,59	30	1RM-15
16 mm	36,62	30	1RM-16
17 mm	36,94	30	1RM-17
18 mm	39,96	30	1RM-18
19 mm	40,30	30	1RM-19
21 mm	43,04	30	1RM-21
22 mm	43,41	30	1RM-22
24 mm	46,91	30	1RM-24
27 mm	54,75	20	1RM-27
30 mm	66,23	20	1RM-30
32 mm	72,06	20	1RM-32

Llave combinada con carraca, pulgadas



### 1RZ

Icon	€	Icon	Icon
1/4 in	26,68	50	1RZ-1/4
5/16 in	26,96	60	1RZ-5/16
11/32 in	23,23	60	1RZ-11/32
3/8 in	27,89	60	1RZ-3/8
7/16 in	30,78	60	1RZ-7/16
1/2 in	34,28	60	1RZ-1/2
9/16 in	35,62	30	1RZ-9/16
5/8 in	39,42	30	1RZ-5/8
11/16 in	41,93	30	1RZ-11/16
3/4 in	45,55	30	1RZ-3/4
7/8 in	50,09	30	1RZ-7/8
15/16 in	60,26	30	1RZ-15/16

Llave combinada con carraca extracorta, mm



### 10RM

Icon	€	Icon	Icon
8 mm	18,12	60	10RM-8
10 mm	20,38	60	10RM-10
13 mm	23,12	60	10RM-13
14 mm	23,50	60	10RM-14
17 mm	27,34	30	10RM-17
19 mm	29,97	30	10RM-19

Llave combinada con carraca extracorta, pulgadas



### 10RZ

Icon	€	Icon	Icon
5/16 in	19,82	1	10RZ-5/16
3/8 in	21,56	1	10RZ-3/8
7/16 in	22,50	1	10RZ-7/16
1/2 in	24,16	1	10RZ-1/2
9/16 in	25,41	1	10RZ-9/16
5/8 in	28,53	1	10RZ-5/8
11/16 in	29,99	1	10RZ-11/16
3/4 in	32,45	1	10RZ-3/4

Llave combinada con carraca articulada, mm



### 41RM

Icon	€	Icon	Icon
8 mm	22,73	60	41RM-8
10 mm	24,76	60	41RM-10
11 mm	26,03	60	41RM-11
12 mm	28,10	60	41RM-12
13 mm	28,91	60	41RM-13
14 mm	30,31	30	41RM-14
17 mm	34,27	30	41RM-17
19 mm	38,72	30	41RM-19
21 mm	40,38	30	41RM-21

Llave combinada con carraca articulada, pulgadas



### 41RZ

Icon	€	Icon	Icon
5/16 in	20,39	1	41RZ-5/16
3/8 in	21,58	1	41RZ-3/8
7/16 in	22,31	1	41RZ-7/16
1/2 in	24,39	1	41RZ-1/2
9/16 in	25,76	1	41RZ-9/16
5/8 in	28,92	30	41RZ-5/8
11/16 in	30,98	1	41RZ-11/16
3/4 in	32,26	1	41RZ-3/4
13/16 in	46,66	30	41RZ-13/16
7/8 in	46,66	1	41RZ-7/8

\* Hasta agotar existencias



Juego de 6 llaves combinadas de carraca reversibles, mm



**1RM/**



€



6 188,96 20 1RM/SH6

1RM-8, 1RM-10, 1RM-12, 1RM-13, 1RM-14, 1RM-17



Juego de 8 llaves combinadas a carraca, mm



**1RM/SH8**



€



8 270,43 1 1RM/SH8

1RM-8, 1RM-10, 1RM-11, 1RM-12, 1RM-13, 1RM-14, 1RM-17, 1RM-19



Juego de 12 llaves combinadas a carraca, mm



**1RM/SH12**



€



12 399,21 10 1RM/SH12

1RM-8, 1RM-9, 1RM-10, 1RM-11, 1RM-12, 1RM-13, 1RM-14, 1RM-15, 1RM-16, 1RM-17, 1RM-18, 1RM-19



Juego 5 llaves combinadas a carraca, mm



**1RM/S5**



€



5 159,88 10 1RM/S5

1RM-8, 1RM-10, 1RM-13, 1RM-17, 1RM-19



Juego de 8 llaves combinadas con carraca, pulgadas



**1RZ/**



€



8 291,44 1 1RZ/SH8

1RZ-5/16, 1RZ-3/8, 1RZ-7/16, 1RZ-1/2, 1RZ-9/16, 1RZ-5/8, 1RZ-11/16, 1RZ-3/4



Juego de 6 llaves combinada con carraca extracortas, mm



**10RM/**



€



6 148,00 1 10RM/SH6

10RM-8, 10RM-10, 10RM-13, 10RM-14, 10RM-17, 10RM-19



Juego de 8 llaves combinadas con carraca articulada, mm



**41RM/SH8**



€



8 241,62 10 41RM/SH8

41RM-8, 41RM-10, 41RM-11, 41RM-12, 41RM-13, 41RM-14, 41RM-17, 41RM-19



Juego de llaves combinadas de carraca y adaptadores, 8 piezas



**1RMA/S8**



€



160 x 283 x 75 mm 143,94 1 1RMA/S8

1RMA-13-3/8-SQ, 1RMA-10-1/4-SQ, 1RMA-19-1/2-SQ



1RMA-13-5/16-BIT, 1RMA-10-1/4-BIT



1RM-13, 1RM-10, 1RM-19



Juego de llaves combinadas con carraca articuladas



**42RM/S12**



g

€

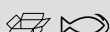

229 x 70 x 280 mm 1562 g 353,26 1 42RM/S12

Llave doble estrella plana a carraca, mm



**1320RM**

	€		
6-7 mm	31,98	60	1320RM-6-7
8-9 mm	32,42	60	1320RM-8-9
10-11 mm	34,39	60	1320RM-10-11
12-13 mm	36,68	60	1320RM-12-13
14-15 mm	40,59	30	1320RM-14-15
16-17 mm	44,56	30	1320RM-16-17
17-19 mm	45,92	30	1320RM-17-19
18-19 mm	47,95	30	1320RM-18-19
22-24 mm	50,52	30	1320RM-22-24

Llave doble estrella plana a carraca, pulgadas



**1320RZ**

	€		
1/4-5/16" in	31,98	60	1320RZ-1/4-5/16
5/16-11/32 in	34,70	60	1320RZ-5/16-11/32
3/8-7/16" in	40,76	60	1320RZ-3/8-7/16
1/2-9/16" in	46,63	30	1320RZ-1/2-9/16
5/8-11/16" in	26,89	30	1320RZ-5/8-11/16
3/4-13/16" in	41,82	30	1320RZ-3/4-13/16
3/4-7/8" in	41,82	30	1320RZ-3/4-7/8
7/8-15/16" in	55,34	30	1320RZ-7/8-15/16

Llave doble de estrella a carraca acodada, pulgadas



**1321RZ**

	€		
3/8-7/16 in	26,13	1	1321RZ-3/8-7/16
1/2-9/16 in	29,45	1	1321RZ-1/2-9/16
5/8-11/16 in	34,09	1	1321RZ-5/8-11/16
3/4x7/8 in	48,20	1	1321RZ-3/4-7/8

Llave doble de estrella plana a carraca



**1320SRM**

	€		
14-19 mm	43,20	1	1320SRM-14-19

Juego de 8 llaves doble estrella plana a carraca, mm



**1320RM/**

	€		
8	326,87	1	1320RM/SH8

1320RM-6-7, 1320RM-8-9, 1320RM-10-11, 1320RM-12-13, 1320RM-14-15, 1320RM-16-17, 1320RM-18-19, 1320RM-22-24

Juego de llaves planas con carraca en S, 29 piezas



**1320SRM/**

	€		
29	133,99	1	1320SRM/S29*

**1320SRM-14-19**

1RMA-19-17-HEX, 1RMA-19-16-HEX, 1RMA-19-15-HEX, 1RMA-19-13-HEX, 1RMA-19-9/16-HEX, 1RMA-19-5/8-HEX, 1RMA-19-11/16-HEX, 1RMA-19-1/2-HEX, 1RMA-19-E18-TX, 1RMA-19-E20-TX, 1RMA-19-E16-TX, 1RMA-19-E22-TX, 1RMA-19-1/2-SQ2, 1RMA-14-11-HEX, 1RMA-14-12-HEX, 1RMA-14-E11-TX, 1RMA-14-E12-TX, 1RMA-14-E10-TX, 1RMA-14-E14-TX, 1RMA-14-E8-TX, 1RMA-14-10-HEX, 1RMA-14-7/16-HEX, 1RMA-14-3/8-HEX, 1RMA-14-5/16-HEX, 1RMA-14-8-HEX, 1RMA-14-9-HEX  
1RMA-19-1/4-SQ

**SBS19-TH22**

Llave de carraca 4 en 1



**S4RM**

	€		
4x5 6x7 mm	21,48	60	S4RM-4-7
8x9 10x11 mm	23,75	60	S4RM-8-11
12x13 14x15 mm	32,07	30	S4RM-12-15
16x17 18x19 mm	38,65	50	S4RM-16-19
20x21 24x27 mm	74,65	20	S4RM-21-27
30x32 34x36 mm	137,41	10	S4RM-30-36

Juego de 3 llaves de carraca 4 en 1



**S4RM/**

	€		
3	97,32	20	S4RM/3T

S4RM-8-11, S4RM-12-15, S4RM-16-19

\* Hasta agotar existencias



Juego de 4 llaves de carraca 4 en 1



**S4RM/4T**

	€		
4	159,09	8	S4RM/4T

S4RM-8-11, S4RM-12-15, S4RM-16-19, S4RM-21-27



Juego de 5 llaves de carraca 4 en 1



**S4RM/5T**

	€		
5	320,61	8	S4RM/5T

S4RM-8-11, S4RM-12-15, S4RM-16-19, S4RM-21-27, S4RM-30-36



Adaptador para llaves con carraca para vasos 1/4", 3/8", 1/2"



**1RMA-SQ**

		€		
1/4 in	10 mm	10,01	1	1RMA-10-1/4-SQ
3/8 in	13 mm	10,53	1	1RMA-13-3/8-SQ
1/2 in	19 mm	11,38	1	1RMA-19-1/2-SQ
1/4 in	19 mm	11,13	100	1RMA-19-1/4-SQ

Adaptador portapuntas para llaves con carraca



**1RMA-BIT**

		€		
1/4	10 mm	7,86	1	1RMA-10-1/4-BIT
5/16	13 mm	8,62	1	1RMA-13-5/16-BIT
10	13 mm	12,39	1	1RMA-13-10-BIT

Juego de 4 adaptadores para llaves de carraca



**1RMA/S4**

	€		
84 x 100 x 35 mm	39,45	30	1RMA/S4

1RMA-10-1/4-SQ, 1RMA-19-1/2-SQ, 1RMA-13-3/8-SQ



1RMA-10-1/4-BIT



**LLAVES FIJAS DE DOS BOCAS**

Llave fija de dos bocas, mm



**6M**

	€		
4x5 mm	5,60	10	6M-4-5
4.5x5.5 mm	7,18	10	6M-4.5-5.5
5x5.5 mm	7,25	10	6M-5-5.5

	€		
5.5x7 mm	5,61	10	6M-5.5-7
6x7 mm	5,61	10	6M-6-7
7x8 mm	5,95	10	6M-7-8
8x9 mm	5,64	10	6M-8-9
8x10 mm	6,07	10	6M-8-10
10x11 mm	6,14	10	6M-10-11
10x13 mm	7,54	10	6M-10-13
12x13 mm	7,47	10	6M-12-13
12x14 mm	7,99	10	6M-12-14
13x14 mm	7,92	10	6M-13-14
13x15 mm	8,79	10	6M-13-15
13x16 mm	9,52	10	6M-13-16
13x17 mm	9,34	10	6M-13-17
14x15 mm	7,92	10	6M-14-15
14x17 mm	9,19	10	6M-14-17
16x17 mm	9,19	10	6M-16-17
16x18 mm	10,05	10	6M-16-18
17x19 mm	10,35	10	6M-17-19
18x19 mm	10,35	10	6M-18-19
19x22 mm	12,52	10	6M-19-22
19x24 mm	13,29	10	6M-19-24
20x22 mm	12,27	10	6M-20-22
21x23 mm	13,37	10	6M-21-23
21x24 mm	14,76	10	6M-21-24
22x24 mm	13,35	10	6M-22-24
24x26 mm	15,53	10	6M-24-26
24x27 mm	15,83	10	6M-24-27
24x30 mm	18,32	5	6M-24-30
25x28 mm	18,05	5	6M-25-28
27x29 mm	21,49	5	6M-27-29
27x30 mm	22,42	5	6M-27-30
27x32 mm	24,53	5	6M-27-32
30x32 mm	24,23	5	6M-30-32
30x36 mm	40,33	5	6M-30-36
32x36 mm	42,41	5	6M-32-36
34x36 mm	44,52	1	6M-34-36
36x41 mm	48,34	1	6M-36-41
38x42 mm	57,47	1	6M-38-42
41x46 mm	68,03	1	6M-41-46
46x50 mm	88,69	1	6M-46-50
4x5 mm	9,88	1	SB6M-4-5
6x7 mm	8,30	1	SB6M-6-7
8x9 mm	7,73	1	SB6M-8-9
10x11 mm	8,21	1	SB6M-10-11
12x13 mm	9,35	1	SB6M-12-13
14x15 mm	9,83	1	SB6M-14-15
16x17 mm	10,89	1	SB6M-16-17
17x19 mm	11,56	1	SB6M-17-19
18x19 mm	11,68	1	SB6M-18-19
20x22 mm	14,01	1	SB6M-20-22
21x23 mm	15,15	1	SB6M-21-23
22x24 mm	14,53	1	SB6M-22-24
24x26 mm	17,22	1	SB6M-24-26
24x27 mm	17,53	1	SB6M-24-27
25x28 mm	18,64	1	SB6M-25-28
27x29 mm	22,66	1	SB6M-27-29
30x32 mm	25,30	1	SB6M-30-32

SB- con clip para colgar



Llave fija de dos bocas, pulgadas



**6Z**

	€		
1/4x5/16 in	5,76	5	6Z-1/4-5/16
5/16x11/32 in	5,76	5	6Z-5/16-11/32
3/8x7/16 in	6,44	5	6Z-3/8-7/16
7/16x1/2 in	7,69	5	6Z-7/16-1/2
1/2x9/16 in	8,15	5	6Z-1/2-9/16
9/16x5/8 in	8,15	5	6Z-9/16-5/8
19/32x11/16 in	10,22	5	6Z-19/32-11/16
5/8x3/4 in	10,61	5	6Z-5/8-3/4
11/16x3/4 in	10,61	5	6Z-11/16-3/4
3/4x7/8 in	12,65	5	6Z-3/4-7/8
25/32x13/16 in	14,61	5	6Z-25/32-13/16
13/16x7/8 in	12,65	5	6Z-13/16-7/8
7/8x15/16 in	16,36	5	6Z-7/8-15/16
15/16x1 in	16,00	5	6Z-15/16-1
1x1.1/8 in	18,53	1	6Z-1-1.1/8
1.1/16x1.1/4 in	24,54	1	6Z-1.1/16-1.1/4
1.1/4x1.3/8 in	42,60	1	6Z-1.1/4-1.3/8

Llave fija de dos bocas, Liliput mm



**1931M**

	€		
4 mm	9,94	5	1931M-4
4.5 mm	9,94	5	1931M-4.5
5 mm	9,94	5	1931M-5
5.5 mm	9,94	5	1931M-5.5
6 mm	9,94	5	1931M-6
7 mm	9,94	5	1931M-7
8 mm	10,36	5	1931M-8
9 mm	11,23	5	1931M-9
10 mm	11,67	5	1931M-10
11 mm	12,54	5	1931M-11
12 mm	12,54	5	1931M-12
13 mm	12,54	5	1931M-13
14 mm	13,38	5	1931M-14
17 mm	17,71	5	1931M-17

Llave fija de dos bocas, Liliput pulgadas



**1931Z**

		€		
1/8 in	74 mm	15,99	5	1931Z-1/8
5/32 in	80 mm	10,36	5	1931Z-5/32
3/16 in	80 mm	10,36	5	1931Z-3/16
13/64 in	80 mm	10,36	5	1931Z-13/64
7/32 in	80 mm	10,36	5	1931Z-7/32
15/64x1/4 in	84 mm	17,87	5	1931Z-15/64-1/4
1/4 in	80 mm	10,36	5	1931Z-1/4
9/32 in	90 mm	10,79	5	1931Z-9/32
9/32x5/16 in	94 mm	16,86	5	1931Z-9/32-5/16
5/16 in	90 mm	11,67	5	1931Z-5/16
11/32 in	105 mm	12,10	5	1931Z-11/32
11/32x3/8 in	94 mm	19,00	5	1931Z-11/32-3/8
3/8 in	105 mm	12,54	5	1931Z-3/8
7/16 in	120 mm	13,38	5	1931Z-7/16
1/2 in	120 mm	13,38	5	1931Z-1/2
9/16 in	130 mm	14,27	5	1931Z-9/16
5/8 in	130 mm	16,40	5	1931Z-5/8

Llave fija DIN895 de dos bocas, mm



**895M**

		€		
6x7 mm	96 mm	3,57	10	895M-6-7
8x9 mm	109 mm	3,23	10	895M-8-9
8x10 mm	115 mm	3,23	10	895M-8-10
10x11 mm	124 mm	3,53	10	895M-10-11
10x13 mm	110 mm	3,53	10	895M-10-13
13x17 mm	155 mm	4,24	10	895M-13-17
17x19 mm	172 mm	5,23	10	895M-17-19
19x22 mm	195 mm	6,41	10	895M-19-22
19x24 mm	206 mm	7,33	5	895M-19-24
22x24 mm	220 mm	7,68	5	895M-22-24
24x27 mm	244 mm	10,19	5	895M-24-27
24x30 mm	265 mm	12,09	5	895M-24-30
27x32 mm	270 mm	14,63	5	895M-27-32
30x32 mm	275 mm	15,40	5	895M-30-32
30x36 mm	305 mm	20,62	1	895M-30-36
32x36 mm	307 mm	20,62	1	895M-32-36
36x41 mm	345 mm	28,56	1	895M-36-41
41x46 mm	381 mm	34,75	1	895M-41-46
46x50 mm	420 mm	41,76	1	895M-46-50
50x55 mm	460 mm	55,05	1	895M-50-55
55x60 mm	500 mm	69,44	1	895M-55-60
65x70 mm	580 mm	136,67	1	895M-65-70

Juego de 8 llaves fijas, mm



**6M/SH**

	€		
8	80,80	1	6M/SH8

6M-6-7, 6M-8-9, 6M-10-11, 6M-12-13, 6M-14-15, 6M-16-17, 6M-18-19, 6M-20-22

Juego de 12 llaves fijas, mm



**6M/SH12**

	€		
12	149,30	1	6M/SH12

6M-6-7, 6M-8-9, 6M-10-11, 6M-12-13, 6M-14-15, 6M-16-17, 6M-18-19, 6M-20-22, 6M-21-23, 6M-24-26, 6M-25-28, 6M-30-32

Juego de 8 llaves fijas de dos bocas, mm



**6M/S**

	€		
8	64,97	1	6M/S8

6M-6-7, 6M-8-9, 6M-10-11, 6M-12-13, 6M-14-15, 6M-16-17, 6M-18-19, 6M-20-22



Juego de 6 llaves fijas en clip, mm



**6M/**

	€		
6	43,06	1	6M/6C

6M-6-7, 6M-8-9, 6M-10-11, 6M-12-13, 6M-14-15, 6M-16-17

Juego de 8 llaves fijas en clip, mm



**6M/8C**

	€		
8	66,23	1	6M/8C

6M-6-7, 6M-8-9, 6M-10-11, 6M-12-13, 6M-14-15, 6M-16-17, 6M-18-19, 6M-20-22

Juego de 10 llaves fijas en clip, mm



**6M/10C**

	€		
10	95,86	1	6M/10C

6M-6-7, 6M-8-9, 6M-10-11, 6M-12-13, 6M-14-15, 6M-16-17, 6M-18-19, 6M-20-22, 6M-24-27, 6M-30-32

Juego de 12 llaves fijas en clip, mm



**6M/12C**

	€		
12	139,44	1	6M/12C

6M-6-7, 6M-8-9, 6M-10-11, 6M-12-13, 6M-14-15, 6M-16-17, 6M-18-19, 6M-20-22, 6M-21-23, 6M-24-27, 6M-25-28, 6M-30-32

Juego de 8 llaves fijas de dos bocas, pulgadas



**6Z/**

	€		
8	77,07	1	6Z/8C

6Z-1/4-5/16, 6Z-3/8-7/16, 6Z-5/16-11/32, 6Z-1/2-9/16, 6Z-19/32-11/16, 6Z-5/8-3/4, 6Z-13/16-7/8, 6Z-15/16-1

Juego de 10 llaves fijas de dos bocas, Liliput



**1931M/**

	€		
10	111,86	1	1931M/10T

1931M-4, 1931M-4.5, 1931M-5, 1931M-5.5, 1931M-6, 1931M-7, 1931M-8, 1931M-9, 1931M-10, 1931M-11

Juego de 12 llaves fijas de dos bocas, Liliput



**1931Z/**

	€		
12	144,61	1	1931Z/12T

1931Z-5/32, 1931Z-9/32, 1931Z-5/16, 1931Z-11/32, 1931Z-3/8, 1931Z-3/16, 1931Z-7/32, 1931Z-1/4, 1931Z-7/16, 1931Z-1/2, 1931Z-5/8, 1931Z-9/16

Juego de 6 llaves fijas de dos bocas para electrónica



**1933M/**

	€		
6	60,33	1	1933M/6T

4x4, 4.5x4.5, 5x5, 5.5x5.5, 6x6, 7x7

Llave magneto en anillo



**3280M/**

	€		
8	17,47	1	3280M

4, 4.5, 5, 5.5, 6, 6.5, 7, 7.5 mm



### Llave fija Crowfoot 1/4"



#### 677-

mm	in	€		
7 mm	1/4 in	33,61	1	677-7
8 mm	1/4 in	33,61	1	677-8
9 mm	1/4 in	33,61	1	677-9
10 mm	1/4 in	33,61	1	677-10
13 mm	1/4 in	33,61	1	677-13
3/8 in	1/4 in	33,25	1	677-3/8

### Llave fija Crowfoot 3/8"



#### 747-

mm	in	€		
10 mm	3/8 in	33,79	1	747-10
11 mm	3/8 in	35,33	1	747-11
12 mm	3/8 in	32,74	1	747-12
13 mm	3/8 in	32,74	1	747-13
14 mm	3/8 in	30,42	1	747-14
15 mm	3/8 in	39,01	1	747-15
16 mm	3/8 in	39,73	1	747-16
17 mm	3/8 in	36,68	1	747-17
18 mm	3/8 in	43,17	1	747-18
19 mm	3/8 in	36,68	1	747-19
20 mm	3/8 in	49,56	1	747-20
21 mm	3/8 in	49,56	1	747-21
22 mm	3/8 in	49,56	1	747-22
23 mm	3/8 in	50,16	1	747-23
24 mm	3/8 in	50,66	1	747-24
25 mm	3/8 in	50,96	1	747-25
26 mm	3/8 in	51,40	1	747-26
27 mm	3/8 in	50,16	1	747-27
28 mm	3/8 in	54,33	1	747-28
30 mm	3/8 in	50,16	1	747-30
32 mm	3/8 in	50,16	1	747-32
34 mm	3/8 in	54,71	1	747-34
36 mm	3/8 in	61,94	1	747-36
40 mm	3/8 in	76,66	1	747-40
41 mm	3/8 in	89,54	1	747-41
42 mm	3/8 in	89,54	1	747-42

mm	in	€		
46 mm	3/8 in	106,09	1	747-46
50 mm	3/8 in	106,09	1	747-50
3/8 in	3/8 in	32,52	1	747-3/8
7/16 in	3/8 in	33,96	1	747-7/16
1/2 in	3/8 in	33,25	1	747-1/2
9/16 in	3/8 in	33,26	1	747-9/16
5/8 in	3/8 in	39,62	1	747-5/8
11/16 in	3/8 in	39,62	1	747-11/16
3/4 in	3/8 in	39,62	1	747-3/4
13/16 in	3/8 in	43,17	1	747-13/16
7/8 in	3/8 in	50,16	1	747-7/8
15/16 in	3/8 in	50,16	1	747-15/16
1 in	3/8 in	50,16	1	747-1
1.1/16 in	3/8 in	50,16	1	747-1.1/16
1.1/8 in	3/8 in	48,33	1	747-1.1/8
1.3/16 in	3/8 in	50,16	1	747-1.3/16
1.1/4 in	3/8 in	50,16	1	747-1.1/4
1.5/16 in	3/8 in	51,40	1	747-1.5/16
1.3/8 in	3/8 in	50,16	1	747-1.3/8
1.7/16 in	3/8 in	61,94	1	747-1.7/16
1.1/2 in	3/8 in	61,94	1	747-1.1/2
1.9/16 in	3/8 in	63,80	1	747-1.9/16
1.5/8 in	3/8 in	83,40	1	747-1.5/8
1.11/16 in	3/8 in	87,70	1	747-1.11/16
1.3/4 in	3/8 in	92,61	1	747-1.3/4
1.13/16 in	3/8 in	100,57	1	747-1.13/16
1.7/8 in	3/8 in	100,57	1	747-1.7/8
1.15/16 in	3/8 in	100,66	1	747-1.15/16
2 in	3/8 in	103,64	1	747-2
2.1/16 in	3/8 in	105,25	1	747-2.1/16
2.1/8 in	3/8 in	133,68	1	747-2.1/8
2.3/16 in	3/8 in	137,36	1	747-2.3/16
2.1/4 in	3/8 in	137,36	1	747-2.1/4
2.5/16 in	3/8 in	137,36	1	747-2.5/16
2.3/8 in	3/8 in	144,38	1	747-2.3/8
2.7/16 in	3/8 in	154,30	1	747-2.7/16
2.1/2 in	3/8 in	154,30	1	747-2.1/2
2.9/16 in	3/8 in	154,30	1	747-2.9/16
2.5/8 in	3/8 in	160,79	1	747-2.5/8
2.3/4 in	3/8 in	160,79	1	747-2.3/4
2.7/8 in	3/8 in	201,64	1	747-2.7/8

### Llave fija Crowfoot 1/2"



#### 787-

mm	in	€		
1.1/16 in	1/2 in	50,16	1	787-1.1/16
1.1/8 in	1/2 in	50,16	1	787-1.1/8
1.3/16 in	1/2 in	56,27	1	787-1.3/16
1.1/4 in	1/2 in	56,27	1	787-1.1/4
1.5/16 in	1/2 in	56,27	1	787-1.5/16
1.3/8 in	1/2 in	61,18	1	787-1.3/8
1.7/16 in	1/2 in	62,41	1	787-1.7/16
1.1/2 in	1/2 in	63,04	1	787-1.1/2
1.5/8 in	1/2 in	69,14	1	787-1.5/8

mm	in	€		
1.11/16 in	1/2 in	140,77	1	787-1.11/16
1.3/4 in	1/2 in	140,77	1	787-1.3/4
1.13/16 in	1/2 in	140,77	1	787-1.13/16
1.7/8 in	1/2 in	153,00	1	787-1.7/8
2 in	1/2 in	153,00	1	787-2
2.1/8 in	1/2 in	171,30	1	787-2.1/8
2.3/16 in	1/2 in	171,30	1	787-2.3/16
2.1/4 in	1/2 in	183,50	1	787-2.1/4
2.3/8 in	1/2 in	195,81	1	787-2.3/8

### Llave fija DIN894 de una boca



#### 894M

mm	L	€		
7 mm	78 mm	3,53	10	894M-7
8 mm	94 mm	3,53	10	894M-8
9 mm	100 mm	3,63	10	894M-9
10 mm	106 mm	3,53	10	894M-10
11 mm	112 mm	3,63	10	894M-11
12 mm	125 mm	3,63	10	894M-12
13 mm	125 mm	3,63	10	894M-13
14 mm	140 mm	4,24	10	894M-14
15 mm	140 mm	4,40	10	894M-15
16 mm	140 mm	4,70	10	894M-16
17 mm	158 mm	3,63	10	894M-17
19 mm	171 mm	4,92	10	894M-19
21 mm	195 mm	5,29	5	894M-21
22 mm	195 mm	6,13	5	894M-22
24 mm	216 mm	7,39	5	894M-24
27 mm	240 mm	8,44	5	894M-27
30 mm	262 mm	9,94	5	894M-30
32 mm	274 mm	11,21	5	894M-32
34 mm	274 mm	18,63	1	894M-34
36 mm	303 mm	14,57	5	894M-36
38 mm	305 mm	22,72	1	894M-38
41 mm	343 mm	23,12	1	894M-41
46 mm	378 mm	26,16	1	894M-46
50 mm	413 mm	32,76	1	894M-50
55 mm	457 mm	38,71	1	894M-55
60 mm	492 mm	54,55	1	894M-60
65 mm	528 mm	65,44	1	894M-65
70 mm	573 mm	76,43	1	894M-70
75 mm	608 mm	131,62	1	894M-75
80 mm	644 mm	155,39	1	894M-80
85 mm	690 mm	189,66	1	894M-85
90 mm	690 mm	212,12	1	894M-90
95 mm	850 mm	322,67	1	894M-95
100 mm	1000 mm	328,94	1	894M-100
105 mm	1000 mm	429,65	1	894M-105
110 mm	1000 mm	480,10	1	894M-110
115 mm	1000 mm	544,55	1	894M-115
120 mm	1000 mm	572,75	1	894M-120
125 mm	1000 mm	660,90	1	894M-125
130 mm	1000 mm	684,68	1	894M-130
135 mm	1000 mm	767,64	1	894M-135



Llave podger acodada de tareas pesadas abierta, en mm



### SC335M

mm	L	€		
17 mm	320 mm	10,48	1	SC335M-17
19 mm	350 mm	15,22	1	SC335M-19
22 mm	350 mm	20,55	1	SC335M-22
24 mm	370 mm	22,41	1	SC335M-24
32 mm	400 mm	39,10	1	SC335M-32
36 mm	430 mm	44,42	1	SC335M-36
41 mm	470 mm	60,09	1	SC335M-41
46 mm	500 mm	75,84	1	SC335M-46

## LLAVES DE ESTRELLA DE DOS BOCAS

Llave de estrella acodada, mm



### 2M

mm	L	€		
6x7 mm	165 mm	10,69	5	2M-6-7
8x9 mm	180 mm	11,71	5	2M-8-9
8x10 mm	180 mm	13,58	5	2M-8-10
10x11 mm	190 mm	12,39	5	2M-10-11
10x13 mm	190 mm	15,71	5	2M-10-13
12x13 mm	210 mm	13,32	5	2M-12-13
13x17 mm	243 mm	14,53	5	2M-13-17
14x15 mm	226 mm	14,12	5	2M-14-15
16x17 mm	246 mm	16,87	5	2M-16-17
16x18 mm	246 mm	20,16	5	2M-16-18
17x19 mm	266 mm	19,66	5	2M-17-19
18x19 mm	266 mm	19,66	5	2M-18-19
19x22 mm	291 mm	23,25	5	2M-19-22
20x22 mm	291 mm	24,12	5	2M-20-22
21x23 mm	306 mm	25,75	5	2M-21-23
22x24 mm	306 mm	28,09	5	2M-22-24
24x26 mm	326 mm	31,83	5	2M-24-26
24x27 mm	326 mm	32,32	5	2M-24-27
25x28 mm	336 mm	37,12	5	2M-25-28
27x29 mm	351 mm	38,18	5	2M-27-29
27x30 mm	351 mm	45,40	5	2M-27-30
27x32 mm	353 mm	45,40	5	2M-27-32

mm	L	€		
30x32 mm	362 mm	45,27	5	2M-30-32
32x36 mm	402 mm	66,51	1	2M-32-36
36x41 mm	438 mm	78,99	1	2M-36-41
41x46 mm	485 mm	104,41	1	2M-41-46
46x50 mm	535 mm	128,87	1	2M-46-50

Llave doble de estrella, extra acodada



### 2Z

mm	L	€		
1/4x5/16 in	165 mm	12,21	1	2Z-1/4-5/16
5/16x3/8 in	180 mm	11,93	1	2Z-5/16-3/8
3/8x7/16 in	190 mm	13,65	1	2Z-3/8-7/16
1/2x9/16 in	210 mm	13,54	1	2Z-1/2-9/16
9/16x5/8 in	225.8 mm	14,53	1	2Z-9/16-5/8
5/8x11/16 in	245.5 mm	17,31	1	2Z-5/8-11/16
3/4x7/8 in	290.5 mm	23,25	1	2Z-3/4-7/8
13/16x7/8 in	290.5 mm	23,25	1	2Z-13/16-7/8
15/16x1 in	325.8 mm	32,01	1	2Z-15/16-1
1x1 1/8 in	335.9 mm	37,93	1	2Z-1-1.1/8
1 1/16x1 1/4 in	353 mm	41,97	1	2Z-1.1/16-1.1/4

Llave de estrella de dos bocas acodada, pulgadas



### 1300Z

mm	L	€		
1/4x5/16 in	156 mm	27,36	1	1300Z-1/4-5/16*
3/8x7/16 in	193 mm	27,36	1	1300Z-3/8-7/16*
1/2x9/16 in	220 mm	30,06	1	1300Z-1/2-9/16*
19/32x11/16 in	258 mm	34,65	1	1300Z-19/32-11/16*
5/8x3/4 in	278 mm	36,90	1	1300Z-5/8-3/4*
25/32x13/16 in	300 mm	51,01	1	1300Z-25/32-13/16*
7/8x15/16 in	334 mm	42,24	1	1300Z-7/8-15/16*
15/16x1 in	352 mm	55,03	1	1300Z-15/16-1*
1x1.1/8 in	380 mm	71,76	1	1300Z-1-1.1/8*

Juego de 8 llaves de estrella de dos bocas extra-acodadas, mm



### 2M/S

	€		
8	121,40	1	2M/S8

2M-6-7, 2M-8-9, 2M-10-11, 2M-12-13, 2M-14-15, 2M-16-17, 2M-18-19, 2M-20-22

Juego de 8 llaves de estrella de dos bocas extra acodadas, mm



### 2M/T

	€		
8	125,71	1	2M/8T

2M-6-7, 2M-8-9, 2M-10-11, 2M-12-13, 2M-14-15, 2M-16-17, 2M-18-19, 2M-20-22

Juego de 10 llaves de estrella de dos bocas acodadas, mm



### 2M/10T

	€		
10	185,93	1	2M/10T

2M-6-7, 2M-8-9, 2M-10-11, 2M-12-13, 2M-14-15, 2M-16-17, 2M-18-19, 2M-20-22, 2M-21-23, 2M-24-27

Juego de 12 llaves de estrella de dos bocas acodadas, mm



**2M/12T**

Icon	€	Icon	Icon
	267,21		1 2M/12T

2M-6-7, 2M-8-9, 2M-10-11, 2M-12-13, 2M-14-15, 2M-16-17, 2M-18-19, 2M-20-22, 2M-21-23, 2M-24-27, 2M-25-28, 2M-30-32

Juego de 7 llaves estrella acodada de dos bocas, pulgadas



**2Z/7T**

Icon	€	Icon	Icon
	111,48		1 2Z/7T

2Z-1/4-5/16, 2Z-5/16-3/8, 2Z-3/8-7/16, 2Z-1/2-9/16, 2Z-9/16-5/8, 2Z-5/8-11/16, 2Z-3/4-7/8

Llave de estrella plana de dos bocas, mm



**4M**

Icon	L	€	Icon	Icon
	95 mm	10,04	10	4M-6-7
	110 mm	10,37	10	4M-8-9
	125 mm	11,53	10	4M-10-11
	140 mm	12,60	10	4M-12-13

Icon	L	€	Icon	Icon
	155 mm	13,81	10	4M-14-15
	170 mm	14,85	10	4M-16-17
	170 mm	15,44	10	4M-17-19
	185 mm	15,44	10	4M-18-19
	205 mm	17,83	10	4M-20-22
	225 mm	19,53	5	4M-21-23
	250 mm	21,91	1	4M-24-26
	255 mm	21,91	1	4M-24-27
	275 mm	24,75	1	4M-25-28
	275 mm	29,69	1	4M-27-29
	300 mm	31,21	1	4M-30-32

Llave de estrella de dos bocas larga, pulgadas



**44Z**

Icon	L	€	Icon	Icon
	197 mm	22,00	10	44Z-1/4-5/16
	238 mm	22,00	10	44Z-5/16-3/8
	284 mm	25,35	10	44Z-3/8-7/16
	326 mm	29,41	10	44Z-7/16-1/2
	358 mm	34,91	10	44Z-1/2-9/16
	401 mm	43,20	5	44Z-5/8-3/4
	401 mm	43,20	5	44Z-11/16-3/4
	410 mm	54,20	5	44Z-11/16-13/16

Llave de estrella de media luna, mm



**1943M**

Icon	L	€	Icon	Icon
	150 mm	28,83	1	1943M-11-13*
	185 mm	30,71	1	1943M-13-15*
	185 mm	32,42	1	1943M-13-17*
	185 mm	33,05	1	1943M-14-17*
	185 mm	33,38	1	1943M-15-17*
	235 mm	35,37	1	1943M-19-22*

Llave de estrella de media luna, pulgadas



**1943Z**

Icon	L	€	Icon	Icon
	153 mm	31,44	1	1943Z-5/16-3/8*
	153 mm	31,44	1	1943Z-7/16-1/2*
	186 mm	32,96	1	1943Z-9/16-5/8*
	233 mm	32,96	1	1943Z-5/8-3/4*
	233 mm	37,00	1	1943Z-11/16-13/16*

Juego de 10 llaves de estrella plana de dos bocas, mm



**4M/10T**

Icon	€	Icon	Icon
	184,19		1 4M/10T

4M-6-7, 4M-8-9, 4M-10-11, 4M-12-13, 4M-14-15, 4M-16-17, 4M-18-19, 4M-20-22, 4M-24-27, 4M-30-32

Juego de 10 llaves de estrella plana de dos bocas, mm



**4M/C**

Icon	€	Icon	Icon
	165,83		1 4M/10C

4M-6-7, 4M-8-9, 4M-10-11, 4M-12-13, 4M-14-15, 4M-16-17, 4M-18-19, 4M-20-22, 4M-21-23, 4M-24-27

\* Hasta agotar existencias



## Juego de 12 llaves estrella plana, mm



### 4M/12C

Icon	€	Icon	Icon
12	222,66	1	4M/12C

4M-6-7, 4M-8-9, 4M-10-11, 4M-12-13, 4M-14-15, 4M-16-17, 4M-18-19, 4M-20-22, 4M-21-23, 4M-24-27, 4M-25-28, 4M-30-32

## Juego de 8 llaves planas de dos bocas, mm



### 4M/

Icon	€	Icon	Icon
8	123,78	1	4M/8

4M-6-7, 4M-8-9, 4M-10-11, 4M-12-13, 4M-14-15, 4M-16-17, 4M-18-19, 4M-20-22

## LLAVES PARA RACORES

### Llave para racores dos bocas, mm



### 1949M

Icon	L	€	Icon	Icon
8x 9 mm	140 mm	23,91	1	1949M-8-9
10x11 mm	150 mm	23,91	1	1949M-10-11
10x12 mm	150 mm	24,81	1	1949M-10-12

Icon	L	€	Icon	Icon
12x13 mm	170 mm	25,55	1	1949M-12-13
12x14 mm	170 mm	26,81	1	1949M-12-14
14x15 mm	170 mm	26,81	1	1949M-14-15
14x17 mm	200 mm	26,81	1	1949M-14-17
17x19 mm	210 mm	36,64	1	1949M-17-19
19x22 mm	220 mm	36,64	1	1949M-19-22
22x24 mm	235 mm	41,93	1	1949M-22-24
24x27 mm	255 mm	53,00	1	1949M-24-27
30x32 mm	280 mm	65,61	1	1949M-30-32

## Llaves para racores, dos bocas, pulgadas



### 1949Z

Icon	L	€	Icon	Icon
3/8x7/16 in	150 mm	25,76	1	1949Z-3/8-7/16
1/2x9/16 in	170 mm	28,92	1	1949Z-1/2-9/16
5/8x3/4 in	210 mm	32,40	1	1949Z-5/8-3/4
3/4x7/8 in	220 mm	34,97	1	1949Z-3/4-7/8
1x1 1/8 in	255 mm	58,36	1	1949Z-1-1.1/8

## Llave Crowfoot 1/4", para racores



### 679-

Icon	Icon	€	Icon	Icon
7 mm	1/4 in	46,37	1	679-7
8 mm	1/4 in	46,37	1	679-8
9 mm	1/4 in	47,35	1	679-9
10 mm	1/4 in	51,56	1	679-10
11 mm	1/4 in	46,37	1	679-11
12 mm	1/4 in	51,98	1	679-12
13 mm	1/4 in	52,23	1	679-13
14 mm	1/4 in	56,24	1	679-14
3/8 in	1/4 in	44,15	1	679-3/8
7/16 in	1/4 in	44,15	1	679-7/16
1/2 in	1/4 in	44,15	1	679-1/2
9/16 in	1/4 in	44,15	1	679-9/16

## Llave Crowfoot 3/8", para racores



### 749-

Icon	Icon	€	Icon	Icon
10 mm	3/8 in	16,13	10	749-10
11 mm	3/8 in	16,13	10	749-11
13 mm	3/8 in	4,67	10	749-13
14 mm	3/8 in	17,51	10	749-14
15 mm	3/8 in	59,49	1	749-15
16 mm	3/8 in	52,74	1	749-16
17 mm	3/8 in	66,38	1	749-17
18 mm	3/8 in	52,74	1	749-18
19 mm	3/8 in	66,38	1	749-19
20 mm	3/8 in	55,19	1	749-20
21 mm	3/8 in	67,75	1	749-21
22 mm	3/8 in	67,75	1	749-22
23 mm	3/8 in	60,72	1	749-23
24 mm	3/8 in	61,51	1	749-24
25 mm	3/8 in	61,94	1	749-25
26 mm	3/8 in	76,75	1	749-26
27 mm	3/8 in	75,72	1	749-27
3/8 in	3/8 in	51,50	1	749-3/8
7/16 in	3/8 in	51,50	1	749-7/16
1/2 in	3/8 in	52,44	1	749-1/2
9/16 in	3/8 in	55,34	1	749-9/16
5/8 in	3/8 in	55,57	1	749-5/8
11/16 in	3/8 in	55,57	1	749-11/16
3/4 in	3/8 in	55,57	1	749-3/4
13/16 in	3/8 in	55,57	1	749-13/16
7/8 in	3/8 in	55,06	1	749-7/8
15/16 in	3/8 in	56,42	1	749-15/16
1 in	3/8 in	56,42	1	749-1
1.1/16 in	3/8 in	56,42	1	749-1.1/16
1.1/8 in	3/8 in	56,42	1	749-1.1/8
1.3/16 in	3/8 in	61,67	1	749-1.3/16
1.1/4 in	3/8 in	65,11	1	749-1.1/4
1.5/16 in	3/8 in	84,32	1	749-1.5/16
1.3/8 in	3/8 in	87,24	1	749-1.3/8
1.7/16 in	3/8 in	88,96	1	749-1.7/16
1.1/2 in	3/8 in	103,52	1	749-1.1/2
1.9/16 in	3/8 in	105,56	1	749-1.9/16
1.5/8 in	3/8 in	109,91	1	749-1.5/8
1.11/16 in	3/8 in	109,91	1	749-1.11/16
1.3/4 in	3/8 in	124,14	1	749-1.3/4
1.13/16 in	3/8 in	127,34	1	749-1.13/16
1.7/8 in	3/8 in	127,34	1	749-1.7/8
1.15/16 in	3/8 in	136,66	1	749-1.15/16
2 in	3/8 in	141,32	1	749-2
2.1/8 in	3/8 in	147,70	1	749-2.1/8
2.3/16 in	3/8 in	147,70	1	749-2.3/16
2.1/4 in	3/8 in	147,70	1	749-2.1/4
2.3/8 in	3/8 in	154,71	1	749-2.3/8
2.5/8 in	3/8 in	172,72	1	749-2.5/8
2.3/4 in	3/8 in	172,72	1	749-2.3/4
3.1/8 in	3/8 in	247,14	1	749-3.1/8



Llave Crowfoot 1/2", para racores



**789-**

mm	in	€		
28 mm	1/2 in	65,01	1	789-28
30 mm	1/2 in	82,53	1	789-30
32 mm	1/2 in	86,66	1	789-32
34 mm	1/2 in	69,91	1	789-34
36 mm	1/2 in	93,57	1	789-36
38 mm	1/2 in	77,27	1	789-38
40 mm	1/2 in	87,09	1	789-40
41 mm	1/2 in	114,35	1	789-41
42 mm	1/2 in	87,09	1	789-42
46 mm	1/2 in	127,29	1	789-46
50 mm	1/2 in	113,45	1	789-50
1.1/8 in	1/2 in	56,42	1	789-1.1/8
1.1/4 in	1/2 in	61,33	1	789-1.1/4
1.5/16 in	1/2 in	65,01	1	789-1.5/16
1.3/8 in	1/2 in	65,01	1	789-1.3/8
1.7/16 in	1/2 in	70,52	1	789-1.7/16
1.1/2 in	1/2 in	70,52	1	789-1.1/2
1.9/16 in	1/2 in	80,94	1	789-1.9/16
1.5/8 in	1/2 in	80,94	1	789-1.5/8
1.3/4 in	1/2 in	93,81	1	789-1.3/4
1.13/16 in	1/2 in	93,81	1	789-1.13/16
2 in	1/2 in	101,79	1	789-2
2.1/4 in	1/2 in	114,07	1	789-2.1/4
2.5/16 in	1/2 in	137,36	1	789-2.5/16
2.3/8 in	1/2 in	142,27	1	789-2.3/8

Llave Crowfoot 3/8", ajustable



**1950MZ**

mm	in	€		
0-29/0-1.1/8 in		79,33	1	1950MZ-3/8

**LLAVES DE GOLPEO**

Llave de estrella de golpe, mm



**7444SG-M**

mm	€		
24 mm	37,37	1	7444SG-M-24
27 mm	40,64	1	7444SG-M-27
30 mm	41,88	1	7444SG-M-30
32 mm	41,88	1	7444SG-M-32
34 mm	61,35	1	7444SG-M-34
36 mm	53,47	1	7444SG-M-36
38 mm	62,92	1	7444SG-M-38
41 mm	68,27	1	7444SG-M-41
42 mm	68,27	1	7444SG-M-42
46 mm	74,82	1	7444SG-M-46
50 mm	84,12	1	7444SG-M-50
55 mm	96,20	1	7444SG-M-55
60 mm	101,40	1	7444SG-M-60
65 mm	135,90	1	7444SG-M-65
70 mm	157,16	1	7444SG-M-70
75 mm	168,76	1	7444SG-M-75
80 mm	224,52	1	7444SG-M-80
85 mm	300,67	1	7444SG-M-85
90 mm	393,10	1	7444SG-M-90
95 mm	434,33	1	7444SG-M-95
100 mm	489,12	1	7444SG-M-100
105 mm	551,78	1	7444SG-M-105
110 mm	608,39	1	7444SG-M-110
115 mm	700,24	1	7444SG-M-115
120 mm	1.019,38	1	7444SG-M-120
125 mm	1.318,72	1	7444SG-M-125
130 mm	1.434,20	1	7444SG-M-130
135 mm	1.479,39	1	7444SG-M-135
140 mm	1.677,78	1	7444SG-M-140
145 mm	2.329,45	1	7444SG-M-145
150 mm	2.452,30	1	7444SG-M-150
155 mm	2.662,55	1	7444SG-M-155
160 mm	2.821,47	1	7444SG-M-160
165 mm	2.997,25	1	7444SG-M-165
170 mm	3.294,40	1	7444SG-M-170
175 mm	3.534,01	1	7444SG-M-175

Llave de estrella de golpe, pulgadas



**7444SG-Z**

in	€		
1 1/16 in	44,71	1	7444SG-Z-1.1/16
1 1/8 in	46,07	1	7444SG-Z-1.1/8
1 3/16 in	46,07	1	7444SG-Z-1.3/16

in	€		
1 1/4 in	46,07	1	7444SG-Z-1.1/4
1 5/16 in	67,51	1	7444SG-Z-1.5/16
1 3/8 in	67,51	1	7444SG-Z-1.3/8
1 7/16 in	67,51	1	7444SG-Z-1.7/16
1 5/8 in	75,09	1	7444SG-Z-1.5/8
1 11/16 in	75,09	1	7444SG-Z-1.11/16
1 3/4 in	82,31	1	7444SG-Z-1.3/4
1 13/16 in	82,31	1	7444SG-Z-1.13/16*
1 7/8 in	92,52	1	7444SG-Z-1.7/8
2 in	92,52	1	7444SG-Z-2
2 1/16 in	105,83	1	7444SG-Z-2.1/16
2 1/8 in	111,57	1	7444SG-Z-2.1/8
2 3/16 in	111,57	1	7444SG-Z-2.3/16
2 1/4 in	111,57	1	7444SG-Z-2.1/4
2 3/8 in	137,80	1	7444SG-Z-2.3/8
2 9/16 in	172,89	1	7444SG-Z-2.9/16
2 5/8 in	172,89	1	7444SG-Z-2.5/8
2 3/4 in	172,89	1	7444SG-Z-2.3/4
3 in	185,64	1	7444SG-Z-3
3 1/8 in	293,92	1	7444SG-Z-3.1/8
3 3/8 in	330,73	1	7444SG-Z-3.3/8
3 1/2 in	432,41	1	7444SG-Z-3.1/2
3 3/4 in	477,78	1	7444SG-Z-3.3/4
3 7/8 in	538,05	1	7444SG-Z-3.7/8
4 in	606,95	1	7444SG-Z-4
4 1/8 in	606,95	1	7444SG-Z-4.1/8
4 1/2 in	770,26	1	7444SG-Z-4.1/2

Llave fija de golpe, mm



**133SGM**

mm	€		
27 mm	29,79	1	133SGM-27
30 mm	34,97	1	133SGM-30
32 mm	37,09	1	133SGM-32
36 mm	47,79	1	133SGM-36
41 mm	58,59	1	133SGM-41
46 mm	78,90	1	133SGM-46
50 mm	89,89	1	133SGM-50
55 mm	104,84	1	133SGM-55
60 mm	116,51	1	133SGM-60
65 mm	146,00	1	133SGM-65
70 mm	188,09	1	133SGM-70
75 mm	201,40	1	133SGM-75
80 mm	263,01	1	133SGM-80
85 mm	276,32	1	133SGM-85
90 mm	352,85	1	133SGM-90
95 mm	371,18	1	133SGM-95
100 mm	569,24	1	133SGM-100
105 mm	635,83	1	133SGM-105
110 mm	694,10	1	133SGM-110
115 mm	812,28	1	133SGM-115
120 mm	825,60	1	133SGM-120

\* Hasta agotar existencias



Llave de estrella de impacto extra-acodada, mm



### 315M

	€		
27 mm	77,70	1	315M-27
30 mm	79,18	1	315M-30
32 mm	77,70	1	315M-32
36 mm	107,56	1	315M-36
41 mm	110,58	1	315M-41
46 mm	143,46	1	315M-46
50 mm	161,37	1	315M-50
55 mm	185,29	1	315M-55
60 mm	239,06	1	315M-60
65 mm	271,93	1	315M-65
70 mm	316,77	1	315M-70
75 mm	328,73	1	315M-75
80 mm	379,51	1	315M-80

Llave de estrella de impacto extra-acodada, pulgadas



### 315Z

	€		
1.1/16 in	71,72	1	315Z-1.1/16
1.1/8 in	71,72	1	315Z-1.1/8
1.3/16 in	74,72	1	315Z-1.3/16
1.1/4 in	77,70	1	315Z-1.1/4
1.5/16 in	80,69	1	315Z-1.5/16
1.3/8 in	101,59	1	315Z-1.3/8
1.7/16 in	95,37	1	315Z-1.7/16
1.1/2 in	97,04	1	315Z-1.1/2
1.5/8 in	113,57	1	315Z-1.5/8
1.11/16 in	116,57	1	315Z-1.11/16
1.3/4 in	125,52	1	315Z-1.3/4
1.13/16 in	128,49	1	315Z-1.13/16
1.7/8 in	137,46	1	315Z-1.7/8
1.15/16 in	140,43	1	315Z-1.15/16
2 mm	140,43	1	315Z-2
2.1/16 in	143,46	1	315Z-2.1/16
2.1/8 in	144,85	1	315Z-2.1/8
2.3/16 in	156,93	1	315Z-2.3/16
2.1/4 in	164,36	1	315Z-2.1/4
2.5/16 in	167,34	1	315Z-2.5/16
2.3/8 in	173,34	1	315Z-2.3/8
2.1/2 in	212,17	1	315Z-2.1/2
2.9/16 in	218,15	1	315Z-2.9/16

	€		
2.5/8 in	221,15	1	315Z-2.5/8
2.3/4 in	221,15	1	315Z-2.3/4
2.7/8 in	262,98	1	315Z-2.7/8
2.15/16 in	265,96	1	315Z-2.15/16
3 mm	271,93	1	315Z-3
3.1/8 in	277,91	1	315Z-3.1/8

Llave a tracción, extra-acodada, mm



### 310M

	€		
24 mm	57,81	1	310M-24
27 mm	57,81	1	310M-27
30 mm	57,81	1	310M-30
32 mm	61,38	1	310M-32
36 mm	70,20	1	310M-36
38 mm	84,47	1	310M-38
41 mm	86,27	1	310M-41
46 mm	96,19	1	310M-46
50 mm	115,82	1	310M-50
55 mm	129,64	1	310M-55
60 mm	159,47	1	310M-60
65 mm	180,32	1	310M-65
70 mm	196,57	1	310M-70
75 mm	214,42	1	310M-75
80 mm	235,55	1	310M-80
85 mm	253,43	1	310M-85
90 mm	503,60	1	310M-90
95 mm	545,83	1	310M-95

Mango tubular



### R310

	€		
24-30 mm	19 mm	44,11	1 R310-0
32-41 mm	22 mm	49,75	1 R310-1
46-55 mm	25 mm	73,73	1 R310-2
60-95 mm	30 mm	94,22	1 R310-3

## LLAVES DE TUBO

Llave de pipa abierta, mm



### 28M

	€		
6 mm	15,19	5	28M-6
7 mm	15,82	5	28M-7
8 mm	13,02	5	28M-8
9 mm	12,90	5	28M-9
10 mm	13,61	5	28M-10
11 mm	14,21	5	28M-11
12 mm	15,07	5	28M-12
13 mm	16,18	5	28M-13
14 mm	18,54	5	28M-14
15 mm	19,64	5	28M-15
16 mm	20,71	5	28M-16
17 mm	21,56	5	28M-17
18 mm	26,01	3	28M-18
19 mm	27,45	3	28M-19
20 mm	29,42	3	28M-20
21 mm	31,98	3	28M-21
22 mm	37,14	3	28M-22
23 mm	38,68	3	28M-23
24 mm	40,99	3	28M-24
25 mm	46,78	3	28M-25
26 mm	50,81	3	28M-26
27 mm	55,49	3	28M-27
28 mm	63,89	1	28M-28
29 mm	72,85	1	28M-29
30 mm	82,68	1	28M-30
32 mm	98,54	1	28M-32
6 mm	12,00	10	SB28M-6
7 mm	12,46	10	SB28M-7
8 mm	13,03	10	SB28M-8
9 mm	13,49	10	SB28M-9
10 mm	14,20	10	SB28M-10
11 mm	14,98	10	SB28M-11
12 mm	15,85	10	SB28M-12
13 mm	16,75	10	SB28M-13
14 mm	19,62	10	SB28M-14
15 mm	20,73	10	SB28M-15
16 mm	21,84	5	SB28M-16
17 mm	22,01	5	SB28M-17
18 mm	27,22	5	SB28M-18
19 mm	28,70	5	SB28M-19
20 mm	30,68	4	SB28M-20
21 mm	33,29	4	SB28M-21
22 mm	38,57	4	SB28M-22
23 mm	40,11	4	SB28M-23
24 mm	42,47	4	SB28M-24

SB: En clip



Llave de pipa abierta, mm



**29M**

	€		
6 mm	15,19	5	29M-6
7 mm	15,82	5	29M-7
8 mm	13,62	5	29M-8
9 mm	13,52	5	29M-9
10 mm	13,61	5	29M-10
11 mm	14,12	5	29M-11
12 mm	15,30	5	29M-12
13 mm	15,86	5	29M-13
14 mm	18,54	5	29M-14
15 mm	19,64	5	29M-15
16 mm	20,71	5	29M-16
17 mm	20,90	5	29M-17
18 mm	26,01	3	29M-18
19 mm	27,45	3	29M-19
20 mm	29,42	3	29M-20
21 mm	31,98	3	29M-21
22 mm	37,14	3	29M-22
23 mm	38,68	3	29M-23
24 mm	40,99	3	29M-24
25 mm	46,78	3	29M-25
26 mm	50,81	3	29M-26
27 mm	55,49	3	29M-27
28 mm	63,89	1	29M-28
29 mm	72,85	1	29M-29
30 mm	82,68	1	29M-30
32 mm	98,54	1	29M-32

Juego de 11 llaves de pipa abiertas, mm



**28M/11**

	€		
11	206,05	1	28M/11

28M-8, 28M-9, 28M-10, 28M-11, 28M-13, 28M-12, 28M-14, 28M-15, 28M-17, 28M-19, 28M-22

Juego de 8 llaves de pipa abiertas, mm



**29M/**

	€		
8	163,55	1	29M/8

29M-8, 29M-10, 29M-12, 29M-13, 29M-14, 29M-17, 29M-19, 29M-22

Juego de 12 llaves de pipa abiertas, mm



**28M/12**

	€		
12	215,62	1	28M/12

28M-8, 28M-9, 28M-10, 28M-11, 28M-12, 28M-13, 28M-14, 28M-15, 28M-16, 28M-17, 28M-18, 28M-19

Juego de 10 llaves de pipa abiertas, mm



**29M/10**

	€		
10	183,46	1	29M/10

29M-8, 29M-10, 29M-11, 29M-12, 29M-13, 29M-14, 29M-16, 29M-17, 29M-18, 29M-19

Juego de 8 llaves de pipa abierta, mm



**28M/**

	€		
8	150,06	1	28M/8

28M-8, 28M-10, 28M-11, 28M-13, 28M-16, 28M-17, 28M-18, 28M-19

Juego de 15 llaves de pipa abiertas, mm



**28M/15**

	€		
15	325,75	1	28M/15

28M-8, 28M-9, 28M-10, 28M-11, 28M-12, 28M-13, 28M-14, 28M-15, 28M-16, 28M-17, 28M-18, 28M-19, 28M-21, 28M-22, 28M-24

Juego de 14 llaves de pipa abiertas, mm



**29M/14**

	€		
14	318,79	1	29M/14

29M-11, 29M-12, 29M-13, 29M-14, 29M-8, 29M-9, 29M-10, 29M-16, 29M-17, 29M-21, 29M-22, 29M-19, 29M-24, 29M-23



Llave de tubo de dos bocas estampada hex, mm



**1936M**

mm	€		
6x7 mm	6,19	50	1936M-6-7
8x9 mm	7,17	5	1936M-8-9
8x10 mm	8,40	30	1936M-8-10
10x11 mm	8,40	25	1936M-10-11
10x13 mm	9,18	25	1936M-10-13
12x13 mm	9,18	25	1936M-12-13
13x17 mm	10,68	20	1936M-13-17
14x15 mm	9,69	20	1936M-14-15
14x17 mm	10,52	15	1936M-14-17
16x17 mm	10,52	15	1936M-16-17
17x19 mm	12,55	10	1936M-17-19
18x19 mm	12,55	10	1936M-18-19
19x22 mm	13,82	8	1936M-19-22
20x22 mm	13,96	8	1936M-20-22
21x23 mm	15,99	8	1936M-21-23
22x24 mm	16,90	5	1936M-22-24
24x26 mm	17,78	5	1936M-24-26
24x27 mm	17,78	5	1936M-24-27
25x28 mm	19,59	5	1936M-25-28
30x32 mm	23,02	1	1936M-30-32
30x34 mm	35,40	4	1936M-30-34
36x41 mm	35,67	4	1936M-36-41
46x50 mm	71,03	2	1936M-46-50

Llave de tubo dos bocas, mm



**27M**

mm	€		
6x7 mm	13,67	10	27M-6-7
8x9 mm	13,81	10	27M-8-9
10x11 mm	14,67	10	27M-10-11
12x13 mm	17,32	10	27M-12-13
13x17* mm	23,08	10	27M-13-17
14x15 mm	19,36	10	27M-14-15
16x17* mm	22,46	10	27M-16-17
16x18* mm	23,89	10	27M-16-18
18x19* mm	26,83	10	27M-18-19
20x22* mm	30,61	10	27M-20-22
21x23* mm	34,04	5	27M-21-23
21x24* mm	35,56	5	27M-21-24
24x26* mm	36,36	5	27M-24-26

mm	€		
24x27* mm	37,00	5	27M-24-27
25x28* mm	41,82	5	27M-25-28
27x29* mm	47,76	5	27M-27-29
30x32* mm	53,52	5	27M-30-32
6x7 mm	14,85	10	SB27M-6-7
8x9 mm	15,00	10	SB27M-8-9
10x11 mm	15,85	10	SB27M-10-11
12x13 mm	18,54	10	SB27M-12-13
14x15 mm	20,55	10	SB27M-14-15
16x17* mm	23,68	10	SB27M-16-17
18x19* mm	28,04	10	SB27M-18-19
20x22* mm	31,77	10	SB27M-20-22
21x23* mm	35,21	5	SB27M-21-23
24x26* mm	39,08	5	SB27M-24-26

\* Con agujero para mango escalonado (26S)

Juego de 7 llaves de tubo de dos bocas, mm



**1936M/**

	€		
7	108,45	1	1936M/7

1936M-8-9, 1936M-10-11, 1936M-12-13, 1936M-14-15, 1936M-16-17, 1936M-18-19, 1936M-20-22

26S-610

Juego de 12 llaves de tubo de dos bocas, mm



**1936M/12**

	€		
12	190,91	1	1936M/12

1936M-6-7, 1936M-8-9, 1936M-10-11, 1936M-12-13, 1936M-14-15, 1936M-16-17, 1936M-18-19, 1936M-20-22, 1936M-21-23, 1936M-24-27, 1936M-25-28, 1936M-30-32

26S-610, 26S-1216, 26S-16

Juego de 8 llaves de tubo dos bocas forjadas, mm



**27M/T**

	€		
8	163,03	1	27M/8T

27M-6-7, 27M-8-9, 27M-10-11, 27M-12-13, 27M-14-15, 27M-16-17, 27M-18-19, 27M-20-22

Juego 12 llaves tubo en bolsa



**27M/12T**

	€		
12	330,91	1	27M/12T

27M-6-7, 27M-8-9, 27M-10-11, 27M-12-13, 27M-14-15, 27M-16-17, 27M-18-19, 27M-20-22, 27M-21-23, 27M-24-26, 27M-25-28, 27M-30-32

Juego de 6 llaves de tubo dos bocas forjadas, mm



**27M/**

	€		
6	101,30	1	27M/6

27M-6-7, 27M-8-9, 27M-10-11, 27M-12-13, 27M-14-15, 27M-16-17

Juego de 8 llaves de tubo de dos bocas forjadas, mm



**27M/8**

	€		
8	158,71	1	27M/8

27M-6-7, 27M-8-9, 27M-10-11, 27M-12-13, 27M-14-15, 27M-16-17, 27M-18-19, 27M-20-22



Juego de 10 llaves de tubo de dos bocas forjadas, mm



**27M/10**

	€		
10	229,09	1	27M/10

27M-6-7, 27M-8-9, 27M-10-11, 27M-12-13, 27M-14-15, 27M-16-17, 27M-18-19, 27M-20-22, 27M-21-23, 27M-24-26



Juego de 12 llaves de tubo de dos bocas forjadas, mm



**27M/12**

	€		
12	324,45	1	27M/12

27M-6-7, 27M-8-9, 27M-10-11, 27M-12-13, 27M-14-15, 27M-16-17, 27M-18-19, 27M-20-22, 27M-21-23, 27M-24-26, 27M-25-28, 27M-30-32



Mango escalonado para llave de tubo



**26S**

	€		
6 8 10 mm	11,68	10	26S-610
12 14 mm	27,27	8	26S-1216
16 mm	7,78	5	26S-16

Llave de vaso articulada de dos bocas, bihexagonal, mm



**4040M**

	€		
6x7 mm	40,12	1	4040M-6-7
8x9 mm	41,09	1	4040M-8-9
10x11 mm	41,98	1	4040M-10-11
10x13 mm	46,63	1	4040M-10-13
12x13 mm	43,72	1	4040M-12-13
13x17 mm	45,58	1	4040M-13-17*
14x15 mm	45,84	1	4040M-14-15
16x17 mm	50,02	1	4040M-16-17
16x18 mm	51,52	1	4040M-16-18*
18x19 mm	57,00	1	4040M-18-19
20x22 mm	67,71	1	4040M-20-22*
21x23 mm	70,54	1	4040M-21-23*
24x27 mm	73,85	1	4040M-24-27

Llave de vaso articulada de dos bocas, bihexagonal, pulgadas



**4040Z**

	€		
3/8x7/16 in	40,53	1	4040Z-3/8-7/16*
1/2x9/16 in	45,01	1	4040Z-1/2-9/16*
5/8x11/16 in	47,98	1	4040Z-5/8-11/16*
5/8x3/4 in	51,21	1	4040Z-5/8-3/4*
13/16x7/8 in	58,83	1	4040Z-13/16-7/8*

Juego de 6 llaves de vaso articuladas de dos bocas, bihexagonal, mm



**4040M/S6**

	€		
6	291,98	1	4040M/S6

4040M-8-9, 4040M-10-11, 4040M-12-13, 4040M-14-15, 4040M-16-17, 4040M-18-19



Juegos de 6 llaves de vaso articuladas de dos bocas, bihexagonal, mm



**4040M/6T**

	€		
6	275,08	1	4040M/6T

4040M-8-9, 4040M-10-11, 4040M-12-13, 4040M-14-15, 4040M-16-17, 4040M-18-19



**LLAVES UNIVERSALES**

Llaves 5 en 1 para armarios de control



**MK5**

	€		
97x25 mm	28,30	1	MK5

Perfil: Cuadrado hembra: 5,6,7-8mm Triángulo hembra: 9mm

\* Hasta agotar existencias



Llave 9 en 1 para armarios de control



**MK9**

L	€		
95x95 mm	43,15	25	MK9

Perfil cuadrado: 5,6,7-8,9-10mm Triángulo: 7,8-9,10-11mm Dos posiciones 3-5 y cierre semiluna 6mm

**LLAVES DE GANCHO ARTICULADAS**

Llave de gancho articulada, mm



**4106**

	€		
19-50 mm	28,18	10	4106-19-50
20-35 mm	36,77	1	4106-20-35*
32-75 mm	41,08	25	4106-32-75
50-120 mm	42,02	25	4106-50-120
115-165 mm	40,60	25	4106-115-165
150-230 mm	90,75	10	4106-150-230

Llave de gancho articulado tipo pin, mm



**40B**

	€		
19-50 mm	24,96	25	40B-19-50
22-35 mm	39,06	1	40B-22-35*
32-75 mm	36,53	25	40B-32-75
50-120 mm	46,07	20	40B-50-120
115-165 mm	62,63	25	40B-115-165
150-230 mm	63,68	10	40B-150-230
165-230 mm	100,89	1	40B-165-230*

Pasador de repuesto para llaves de gancho ajustables



**40B-SP**

	€		
40B-19-50	3,72	1	40B-19-50-SP
40B-32-75	3,72	1	40B-32-75-SP
40B-50-120	4,40	1	40B-50-120-SP
40B-115-165	4,40	1	40B-115-165-SP

Llave pivote, ajustable



**4307/4310**

	€		
10-50 mm	78,85	1	4307
22-100 mm	106,55	1	4310



## Llaves de vaso y carracas



## JUEGOS DE VASOS

Juego de vasos 1/4", 1/2" y llaves combinadas



**S910**



€



110 x 320 x 375 mm 224,91 2 S910

Juego de vasos 1/4", 1/2" llaves mixtas, 106 piezas



**S106**



€



110 x 430 x 375 mm 315,09 2 S106

Juego de vasos 1/4" y 1/2", 81 piezas



**S81MIX**



€



110 x 430 x 375 mm 228,09 2 S81MIX

Juego de vasos y llaves combinadas de 95 piezas 1/4" y 1/2"



**S95**



€



110 x 320 x 375 mm 242,14 2 S95

Juego de vasos 1/4" y llaves combinadas 1/4" y 1/2", 103 piezas



**S103**



€



110 x 375 x 430 mm 297,74 2 S103

Juego de llaves de vaso cuadradas de 1/2" con perfil hexagonal métrico y llaves combinadas/juego de puntas/martillo/ alicates - 71 piezas



**S71MIX**



€



110 x 430 x 375 mm 180,25 2 S71MIX

Juego de vasos 1/4" y 1/2" con llaves de vaso, 94 piezas



**S87+7**



€



110 x 430 x 375 mm 270,53 2 S87+7

Juego de vasos 1/2"+1/4", 108 piezas



**S108**



€



110 x 430 x 375 mm 316,15 2 S108

Juego de vasos de 1/4" - 1/2", 41 piezas



**S410**



€



110 x 320 x 375 mm 130,49 2 S410



Juego de vasos 1/4" y 1/2", 77 piezas



**S800**

110 x 375 x 430 mm € 299,28 2 S800

Juego de vasos y puntas 1/4" y 3/8", mm, 91 piezas



**SL91**

100 x 215 x 370 mm € 182,67 4 SL91\*

Juego de vasos 1/4", 3/8", 1/2", 137 piezas



**S137**

105 x 370 x 430 mm € 431,42 2 S137

Juego de vasos y puntas 1/4" y 1/2", mm, 79 piezas



**SW79**

100 x 215 x 370 mm € 180,35 4 SW79

Juego de vasos y puntas 1/4" y 3/8", mm, 91 piezas



**SW91**

100 x 215 x 370 mm € 196,27 4 SW91\*

Juego de 10 vasos serie larga 1/4", 10 piezas



**S0810L**

35 x 85 x 160 mm € 32,80 20 S0810L

Juego vasos de 1/2" y 1/4", 56 piezas



**S560**

100 x 215 x 375 mm € 122,00 4 S560

Juego vasos 1/4" y 1/2" y llaves combinadas, 138 piezas



**S138**

110 x 375 x 430 mm € 334,18 2 S138

Juego de vasos 1/4", 25 piezas



**SL25**

35 x 85 x 160 mm € 44,11 20 SL25

\* Hasta agotar existencias



Juego de llaves de vaso cuadradas de 1/4" con perfil métrico bi-hex y puntas de destornillador/portapuntas - 39 piezas



**S39MH**

€ 30,39 20 S39MH

35 x 85 x 160 mm

Juego de vasos 1/4", 24 piezas



**SL24**

€ 44,51 30 SL24

35 x 85 x 160 mm

Juego de vasos 1/4", 16 piezas



**S160**

€ 50,92 6 S160

70 x 160 x 280 mm

Juego de llaves de vaso cuadradas de 1/4" con perfil métrico bi-hex y puntas de destornillador/sopORTE de puntas Paquete al por menor- 39 piezas



**SBS39MH**

€ 31,42 24 SBS39MH

35 x 85 x 160 mm

SB=embalaje en blister

Juego de vasos de 1/4", 37 piezas



**SL25L**

€ 61,98 10 SL25L

46 x 130 x 195 mm

Juego de vasos 1/4", 29 piezas



**S290**

€ 73,74 6 S290

70 x 160 x 280 mm

Juego de vasos 1/4" en mm y puntas, 37 piezas, en blister



**SBSL25**

€ 47,62 5 SBSL25

55 x 80 x 165 mm

SB=embalaje en blister

Juego de vasos largos 1/4" en mm y puntas, 37 piezas, en blister



**SBSL25L**

€ 48,18 10 SBSL25L

46 x 130 x 195 mm

Juego de vasos 1/4", 46 piezas



**S460**

€ 114,24 6 S460

100 x 215 x 375 mm

Juego de vasos y puntas 1/4", 65 piezas



**SL65**



€



70 x 160 x 280 mm

89,12

6

SL65

Juego vasos 1/4" y puntas, 65 piezas



**SW65**



€



70 x 160 x 280 mm

95,48

6

SW65

Juego vasos 1/4", 25 piezas, en pulgadas



**SL25AF**



€



35 x 85 x 165 mm

44,11

20

SL25AF

Juego de vasos 1/4", 16 piezas



**S160AF**



€



70 x 160 x 280 mm

50,92

6

S160AF

Juego de vasos 1/4", 12 piezas



**6712RN**



€



31 x 108 x 178 mm

123,98

1

6712RN

6700SM-4, 6700SM-5, 6700SM-5.5, 6700SM-6, 6700SM-7, 6700SM-8, 6700SM-10, 6700SM-11, 6700SM-13

6960, 6962, 6960-6

6950RN

4750BMC3

Juego de vasos 1/4", 15 piezas



**A6716DM**



€



35 x 111 x 223 mm

158,17

1

A6716DM

A6700DM-5.5, A6700DM-6, A6700DM-7, A6700DM-8, A6700DM-9, A6700DM-10, A6700DM-11, A6700DM-12, A6700DM-13, A6700DM-14

6956

6962, 6960-6

6966

6954-5

6950

4750BMC4

Juego de vasos 1/4", 16 piezas



**6715MGS**



€



34 x 113 x 223 mm

171,89

1

6715MGS

SB6700SM-4, 6700SM-4.5, 6700SM-5, 6700SM-5.5, 6700SM-6, 6700SM-6, 6700SM-7, 6700SM-8, 6700SM-9, 6700SM-10, 6700SM-11, 6700SM-13

6954-5

6950RN

6956

6966

6962, 6960-6





Juego de vasos 1/4", 32 piezas



**6719MHR**

	€			
50 x 110 x 220 mm	185,03	1	6719MHR	

6700SM-4, 6700SM-4.5, 6700SM-5.5, 6700SM-5, 6700SM-6, 6700SM-7, 6700SM-8, 6700SM-9, 6700SM-10, 6700SM-11, 6700SM-12, 6700SM-13, 6700SM-14		
6950RN		
6960, 6962, 6960-6		
6954-5		
6956		
6966		

Juego de vasos 1/4", 15 piezas



**6729MHR**

	€			
50 x 110 x 220 mm	195,45	1	6729MHR	

6700SM-4, 6700SM-5, 6700SM-6, 6700SM-7, 6700SM-8, 6700SM-9, 6700SM-10, 6700SM-11, 6700SM-13, 6700SM-14		
6950RN		
6960, 6962, 6960-6		
6966		
6956		
6973A		
59S/PH1, 59S/PH2, 59S/PH3		
59S/PZ1, 59S/PZ2, 59S/PZ3		
59S/0.6-4.5, 59S/0.8-5.5, 59S/1.2-6.5		
59S/H3, 59S/H4, 59S/H5, 59S/H6		

Juego de vasos 1/4", 16 piezas



**6729MHP**

	€			
50 x 110 x 220 mm	198,88	1	6729MHP	

6700SM-4, 6700SM-5, 6700SM-6, 6700SM-7, 6700SM-8, 6700SM-9, 6700SM-10, 6700SM-11, 6700SM-13, 6700SM-14		
6950		
6960, 6962, 6960-6		
6966		
6956		
6973A		
59S/0.6-4.5, 59S/0.8-5.5, 59S/1.2-6.5		
59S/PZ1, 59S/PZ2, 59S/PZ3		
59S/PH1, 59S/PH2, 59S/PH3		
59S/H3, 59S/H4, 59S/H5, 59S/H6		

Juego de vasos 1/4", 17 piezas



**6717MBP**

	€			
50 x 110 x 220 mm	179,21	1	6717MBP	

A6700DM-5, A6700DM-5.5, A6700DM-6, A6700DM-7, A6700DM-8, A6700DM-9, A6700DM-10, A6700DM-11, A6700DM-12, A6700DM-13, A6700DM-14		
6950		
6960, 6962, 6960-6		
6954-5		
6966		
6956		

Juego de vasos 1/4", 27 piezas



**6730MBP**

	€			
50 x 110 x 220 mm	203,52	1	6730MBP	

A6700DM-5, A6700DM-5.5, A6700DM-6, A6700DM-7, A6700DM-8, A6700DM-9, A6700DM-10, A6700DM-11, A6700DM-12, A6700DM-13, A6700DM-14		
6950		
6960, 6962, 6960-6		
6954-5		
6966		
6956		
6973A		
59S/0.6-4.5, 59S/1.2-6.5, 59S/0.8-5.5		
59S/PH1, 59S/PH2, 59S/PH3		
59S/PZ1, 59S/PZ2, 59S/PZ3		
59S/H3, 59S/H4, 59S/H5, 59S/H6		

Juego de vasos 1/4", 17 piezas



**6719SM**

	€			
41 x 113 x 223 mm	175,31	1	6719SM	

6700SM-4, 6700SM-4.5, 6700SM-5, 6700SM-5.5, 6700SM-6, 6700SM-7, 6700SM-8, 6700SM-9, 6700SM-10, 6700SM-11, 6700SM-12, 6700SM-13		
6954-5		
6950		
6956		
6966		
6962, 6960-6		

Juego de vasos 1/4", 20 piezas



**6715MG**

35 x 111 x 223 mm € 211,65 1 6715MG

6700SM-4, 6700SM-4.5, 6700SM-5, 6700SM-5.5, 6700SM-6, 6700SM-7, 6700SM-8, 6700SM-9, 6700SM-10, 6700SM-11, 6700SM-12, 6700SM-13, 6700SM-14	
6954-5	
6958	
6956	
6962, 6960, 6960-6	
6966	
6950RN	

Juego de vasos 1/4", 27 piezas



**6722M**

41 x 113 x 223 mm € 233,63 1 6722M

6700SM-4, 6700SM-5, 6700SM-6, 6700SM-7, 6700SM-8, 6700SM-9, 6700SM-10, 6700SM-11, 6700SM-13, 6700SM-14	
6954-5	
6956	
6950	
6966	
6960, 6962, 6960-6	
6972H	
59S/H3, 59S/H4, 59S/H5, 59S/H6	
59S/PH1, 59S/PH2, 59S/PH3	

Juego de vasos 1/4", 29 piezas



**6715PZ**

41 x 113 x 223 mm € 262,88 1 6715PZ

6700SM-4, 6700SM-4.5, 6700SM-5, 6700SM-5.5, 6700SM-6, 6700SM-7, 6700SM-8, 6700SM-9, 6700SM-10, 6700SM-11, 6700SM-12, 6700SM-13	
6956	
6950	
6954-5	
6962, 6960, 6960-6	
6966	
6709F-4.5, 6709F-5.5, 6709F-8	
6709M-3, 6709M-4, 6709M-5, 6709M-6, 6709M-8	
6709PZ-1, 6709PZ-3, 6709PZ-2	

Juego de vasos 1/4", 21 piezas



**6721NM**

41 x 113 x 223 mm € 286,40 1 6721NM

6700SM-4, 6700SM-4.5, 6700SM-5, 6700SM-5.5, 6700SM-6, 6700SM-7, 6700SM-8, 6700SM-9, 6700SM-10, 6700SM-11, 6700SM-12, 6700SM-13, 6700SM-14	
6954-5	
6951	
6956	
6950	
6962, 6960, 6960-6	
6966	
6958	

Juego de vasos 1/4", 27 piezas



**6715GE**

31 x 113 x 223 mm € 230,19 1 6715GE

6700SM-4, 6700SM-5, 6700SM-6, 6700SM-7, 6700SM-8, 6700SM-9, 6700SM-10, 6700SM-11, 6700SM-13, 6700SM-14	
6956	
6950RN	
6954-5	
6966	
6960, 6962, 6960-6	
6972H	
59S/H3, 59S/H4, 59S/H5, 59S/H6	
59S/PH1, 59S/PH2, 59S/PH3	

Juego de vasos, 29 piezas



**6715GJ**

50 x 113 x 223 mm € 263,84 1 6715GJ

6700SM-4, 6700SM-4.5, 6700SM-5, 6700SM-5.5, 6700SM-6, 6700SM-7, 6700SM-8, 6700SM-9, 6700SM-10, 6700SM-11, 6700SM-12, 6700SM-13	
6956	
6962, 6960, 6960-6	
6709F-4.5, 6709F-5.5, 6709F-8	
6709M-5, 6709M-6, 6709M-8, 6709M-4, 6709M-3	
6954-5	
6950	
6966	
6709PH-1, 6709PH-2, 6709PH-3	





Juego de vasos 1/4", 33 piezas



### 6720NM

	€		
43 x 114 x 351 mm	320,71	1	6720NM

6700SM-4, 6700SM-4.5, 6700SM-5, 6700SM-5.5, 6700SM-6, 6700SM-7, 6700SM-8, 6700SM-9, 6700SM-10, 6700SM-11, 6700SM-12, 6700SM-13, 6700SM-14		
1931M-4, 1931M-4.5, 1931M-9, 1931M-10, 1931M-11, 1931M-14, 1931M-13, 1931M-12, 1931M-7, 1931M-8, 1931M-6, 1931M-5.5, 1931M-5		
6954-5		
6950		
6956		
221 D		
73721-3-80		
6966		
6962, 6960-6		

Juego de llaves de vaso 1/4", 15 piezas, pulgadas



### A6716DZ

	€		
41 x 113 x 223 mm	170,34	1	A6716DZ

A6700DZ-3/16, A6700DZ-7/32, A6700DZ-1/4, A6700DZ-9/32, A6700DZ-5/16, A6700DZ-11/32, A6700DZ-3/8, A6700DZ-7/16, A6700DZ-1/2, A6700DZ-9/16		
6956		
6962, 6960-6		
6966		
6954-5		
6950		
4750BMC4		

Juego de vasos 1/4", 18 piezas, pulgadas



### A6718DZ

	€		
41 x 113 x 223 mm	187,41	1	A6718DZ

6950		
6951		
6956		
6954-5		
6958		
6960, 6962, 6960-6		
6966		
A6700DZ-3/16, A6700DZ-7/32, A6700DZ-1/4, A6700DZ-9/32, A6700DZ-5/16, A6700DZ-11/32, A6700DZ-3/8, A6700DZ-7/16, A6700DZ-1/2, A6700DZ-9/16		

Juego de vasos 1/4", 25 piezas, mm y pulgadas



### 6715MZ

	€		
40 x 126 x 230 mm	213,07	1	6715MZ

6700SM-4, 6700SM-4.5, 6700SM-5, 6700SM-5.5, 6700SM-6, 6700SM-8, 6700SM-9, 6700SM-10, 6700SM-11, 6700SM-13		
6700SZ-7/32, 6700SZ-3/16, 6700SZ-1/4, 6700SZ-9/32, 6700SZ-5/16, 6700SZ-11/32, 6700SZ-3/8, 6700SZ-7/16, 6700SZ-1/2		
6954-5		
6950		
6956		
6966		
6962, 6960-6		

Juego de 9 vasos largos de 1/4" para tornillos de cabeza hexagonal métricos e imperiales



### A6709MZ/9

	€		
46 x 130 x 195 mm	207,41	1	A6709MZ/9

A6709M-2.5, A6709M-3, A6709M-4, A6709M-5, A6709M-6		
A6709Z-1/8, A6709Z-9/64, A6709Z-5/32, A6709Z-3/16		
SPAR-CASE-A6		

Juego de vasos 1/4" en rail, 13 piezas, en mm



### 6729SM

	€		
25 x 55 x 190 mm	82,06	1	6729SM

6700SM-4, 6700SM-4.5, 6700SM-5, 6700SM-5.5, 6700SM-6, 6700SM-7, 6700SM-8, 6700SM-9, 6700SM-10, 6700SM-11, 6700SM-12, 6700SM-13, 6700SM-14		
6956		

Juego de vasos 7 piezas



### 6729SZ

	€		
25 x 55 x 190 mm	54,86	1	6729SZ

6700SZ-1/4, 6700SZ-11/32, 6700SZ-1/2, 6700SZ-3/16, 6700SZ-7/32, 6700SZ-3/8, 6700SZ-7/16		
6956		

Juego de 13 llaves de vaso 1/4", en rail, mm



**6713MH**

		€		
13	260 g	70,70	1	6713MH

6700SM-4, 6700SM-4.5, 6700SM-5, 6700SM-5.5, 6700SM-6, 6700SM-7, 6700SM-8, 6700SM-9, 6700SM-10, 6700SM-11, 6700SM-12, 6700SM-13, 6700SM-14

Juego de 8 vasos 1/4" en rail, mm



**6708DMB**

		€		
8	340 g	97,43	1	6708DMB

A6800DM-6, A6800DM-7, A6800DM-8, A6800DM-9, A6800DM-10, A6800DM-11, A6800DM-12, A6800DM-13

Juego de 11 vasos 1/4", en rail



**6711MB**

		€		
11	240 g	61,54	1	6711MB

A6700DM-5, A6700DM-5.5, A6700DM-6, A6700DM-7, A6700DM-8, A6700DM-9, A6700DM-10, A6700DM-11, A6700DM-12, A6700DM-13, A6700DM-14

Juego de 6 llaves vaso 1/4" en rail



**6706TE**

		€		
6	150 g	48,41	1	6706TE

6700TORX-E4, 6700TORX-E5, 6700TORX-E6, 6700TORX-E7, 6700TORX-E8, 6700TORX-E10

Juego de herramientas en caja de metal, mm



**R6725MK**

	€		
26 x 105 x 175 mm	266,87	1	R6725MK

6700SM-7, 6700SM-8, 6700SM-10

6954-5

R6967

R6810M-3.4, R6810M-4, R6810M-4.5, R6810M-5, R6810M-6, R6810M-7, R6810M-8, R6810M-9, R6810M-10

6966

R6950

6962, 6960-6

R6964A

Juego de herramientas en caja de metal, pulgadas



**R6725ZK**

	€		
48 x 115 x 225 mm	256,31	1	R6725ZK

6700SZ-1/4, 6700SZ-5/16, 6700SZ-11/32, 6700SZ-3/8, 6700SZ-7/16, 6700SZ-1/2

6954-5

R6967

R6950

6962, 6960-6

R6810M-6

R6964A

6966

R6810Z-3/16, R6810Z-7/32, R6810Z-1/4, R6810Z-5/16, R6810Z-3/8

R6822Z

Juego de 14 vasos 3/8" serie larga



**S1214L**

	€		
49 x 152 x 280 mm	60,00	10	S1214L

Juego de llaves de vaso 1/4" y 3/8", 33 piezas



**S330**

	€		
70 x 160 x 280 mm	80,61	6	S330



Juego de vasos 1/4" y 3/8", 53 piezas



**S330L**

	€		
100 x 215 x 375 mm	117,43	4	S330L

Juego vasos 3/8", 38 piezas



**S380**

	€		
100 x 215 x 375 mm	116,55	4	S380

Juego de vasos 3/8" con cabeza delgada, 34 piezas



**SL34**

	€		
70 x 160 x 280 mm	85,82	6	SL34

Juego de vasos con accionamiento exterior y carraca pasante, 14 piezas



**S140T**

	€		
65 x 160 x 280 mm	73,03	10	S140T

SBS19-THR

SBS19-TH75

SBS19-TH10, SBS19-TH11, SBS19-TH12, SBS19-TH13, SBS19-TH14, SBS19-TH15, SBS19-TH16, SBS19-TH17, SBS19-TH18, SBS19-TH19, SBS19-TH21, SBS19-TH22, SBS19-TH24

SBS19-TH20

Juego de llave de carraca con cuadrado pasante, 3 piezas



**S140T-R**

	€		
121 x 280 x 220 mm	44,56	10	S140T-R

Carraca 72 dientes, Adaptador 19mm-3/4" para cuadrado 3/8", Adaptador 19mm-3/4" para cuadrado 1/2"

SBS19-THR

1RMA-19-3/8-SQ

1RMA-19-1/2-SQ

Juego de vasos pasantes, 53 piezas



**S530T**

	€		
90 x 205 x 370 mm	202,30	4	S530T

Juego de vasos de 3/8 y 1/4"



**S330AF**

	€		
70 x 160 x 280 mm	80,61	6	S330AF

Juego de vasos 3/8" 22 piezas, Bihex.,mm



**A7435DME**

	€		
40 x 150 x 500 mm	340,32	1	A7435DME*

A7400DM-9, A7400DM-10, A7400DM-11, A7400DM-12, A7400DM-13, A7400DM-14, A7400DM-15, A7400DM-16, A7400DM-17, A7400DM-18, A7400DM-19, A7400DM-20, A7400DM-21, A7400DM-22

7755-3/8

7754, 7760, 7761

7762, 7760-3, 7760-5

7758

7752

7766

7760-10

Juego de vasos 3/8", 22 piezas



**7422MBR**

60 x 220 x 280 mm € 256,19 1 7422MBR

A7400DM-6, A7400DM-7, A7400DM-8, A7400DM-9, A7400DM-10, A7400DM-11, A7400DM-12, A7400DM-13, A7400DM-14, A7400DM-15, A7400DM-16, A7400DM-17, A7400DM-18, A7400DM-19, A7400DM-20, A7400DM-21, A7400DM-22

- 7750RN
- 7760, 7754
- 7762, 7760-3
- 7766
- 7760-10

Juego de vasos 3/8", 22 piezas



**7422MHR**

50 x 160 x 350 mm € 249,11 1 7422MHR

7400SM-6, 7400SM-7, 7400SM-8, 7400SM-9, 7400SM-10, 7400SM-11, 7400SM-12, 7400SM-13, 7400SM-14, 7400SM-15, 7400SM-16, 7400SM-17, 7400SM-18, 7400SM-19, 7400SM-20, 7400SM-21, 7400SM-22

- 7750RN
- 7760, 7754
- 7762, 7760-3
- 7766
- 7760-10

Juego de vasos 3/8", 20 piezas, Bihex., pulgadas



**A7535DZE**

165 x 500 x 45 mm € 409,49 1 A7535DZE\*

A7400DZ-1/2, A7400DZ-17/32, A7400DZ-1/4, A7400DZ-3/4, A7400DZ-13/16, A7400DZ-19/32, A7400DZ-11/16, A7400DZ-3/8, A7400DZ-7/16, A7400DZ-5/16, A7400DZ-7/8, A7400DZ-9/16, A7400DZ-5/8

- 7755-3/8
- 7754, 7760
- 7766
- 7758
- 7752
- 7762, 7760-3
- 7760-10

Juego de vasos 3/8" 12 piezas, en rail



**7400SR/**

12 35 x 220 x 25 mm € 84,69 1 7400SR/S12

7400SM-11, 7400SM-10, 7400SM-15, 7400SM-14, 7400SM-13, 7400SM-12, 7400SM-16, 7400SM-9, 7400SM-8, 7400SM-17, 7400SM-19, 7400SM-18

Juego de 9 vasos 3/8" en rail, mm



**7409MB**

9 370 g € 71,57 1 7409MB

A7400DM-7, A7400DM-8, A7400DM-10, A7400DM-11, A7400DM-13, A7400DM-15, A7400DM-17, A7400DM-19, A7400DM-22

Juego de 8 vasos 3/8" en rail, mm



**7408MD**

8 690 g € 121,67 1 7408MD

A7402DM-10, A7402DM-11, A7402DM-12, A7402DM-13, A7402DM-14, A7402DM-16, A7402DM-17, A7402DM-19

Juego de 7 vasos 3/8"



**7400TORX-ER/**

7 25 x 55 x 190 mm € 82,62 1 7400TORX-ER/S7

7400TORX-E14, 7400TORX-E12, 7400TORX-E11, 7400TORX-E10, 7400TORX-E18, 7400TORX-E16, 7400TORX-E8

\* Hasta agotar existencias





Juego de 12 vasos 1/2" serie larga



**S1612L**

49 x 152 x 280 mm € 73,78 4 S1612L

7805SM-10, 7805SM-11, 7805SM-12, 7805SM-13, 7805SM-14, 7805SM-15, 7805SM-16, 7805SM-17, 7805SM-18, 7805SM-19, 7805SM-20, 7805SM-21

Juego de vasos 1/2" con puntas hexagonales, 9 piezas



**S9HEX**

46 x 130 x 195 mm € 50,92 10 S9HEX

7809M-4, 7809M-5, 7809M-6, 7809M-7, 7809M-8, 7809M-10, 7809M-12, 7809M-14, 7809M-17

Juego de 9 vasos de 1/2" con puntas TORX



**S9TORX**

46 x 130 x 195 mm € 50,92 10 S9TORX

7809TORX-T20, 7809TORX-T25, 7809TORX-T27, 7809TORX-T30, 7809TORX-T40, 7809TORX-T45, 7809TORX-T50, 7809TORX-T55, 7809TORX-T60

Juego de vasos 1/2" con puntas hexagonales, 18 piezas



**S18HEX**

100 x 210 x 370 mm € 101,63 4 S18HEX

Juego de 18 vasos de 1/2" con puntas TORX



**S18TORX**

100 x 210 x 370 mm € 104,03 4 S18TORX

Juego de vasos 1/2", 24 piezas



**S240**

100 x 215 x 375 mm € 127,67 4 S240

8150QR

8166

8160-5, 8160-10

7772H

8158-10

7800SM-10, 7800SM-11, 7800SM-12, 7800SM-13, 7800SM-14, 7800SM-15, 7800SM-16, 7800SM-17, 7800SM-18, 7800SM-19, 7800SM-20, 7800SM-21, 7800SM-22, 7800SM-23, 7800SM-24, 7800SM-27, 7800SM-30, 7800SM-32

S240-BOX

Juego de vasos de 1/2" con perfil estriado en mm y carraca - 24 piezas



**S240-SPL**

100 x 215 x 375 mm € 125,35 4 S240-SPL

8150QR

8158-10

8166

7772H

8160-5, 8160-10

7800SPL-10, 7800SPL-11, 7800SPL-12, 7800SPL-13, 7800SPL-14, 7800SPL-15, 7800SPL-16, 7800SPL-17, 7800SPL-18, 7800SPL-19, 7800SPL-20, 7800SPL-21, 7800SPL-22, 7800SPL-23, 7800SPL-24, 7800SPL-27, 7800SPL-30, 7800SPL-32

Juego de vasos 1/2" y llaves mixtas, 40 piezas



**S400**

110 x 320 x 375 mm € 189,15 2 S400

8150QR

8158-10

8166

7772H

8160-5, 8160-10

7800SM-10, 7800SM-11, 7800SM-12, 7800SM-13, 7800SM-14, 7800SM-15, 7800SM-16, 7800SM-17, 7800SM-18, 7800SM-19, 7800SM-20, 7800SM-21, 7800SM-22, 7800SM-23, 7800SM-24, 7800SM-25, 7800SM-26, 7800SM-27, 7800SM-28, 7800SM-30, 7800SM-32



111M-7, 111M-8, 111M-9, 111M-10,  
111M-11, 111M-12, 111M-13, 111M-14,  
111M-15, 111M-16, 111M-17, 111M-18,  
111M-19



### Juego de vasos 1/2"



### S240AF

100 x 215 x 375 mm € 127,67 4 S240AF

8150QR

8158-10

7805GPR-16, 7805GPR-21

8166

7772H

8160-5, 8160-10

7800SZ-3/8, 7800SZ-7/16, 7800SZ-1/2,  
7800SZ-9/16, 7800SZ-5/8, 7800SZ-  
11/16, 7800SZ-3/4, 7800SZ-13/16,  
7800SZ-7/8, 7800SZ-15/16, 7800SZ-1,  
7800SZ-1.1/16, 7800SZ-1.1/8, 7800SZ-  
1.3/16, 7800SZ-1.1/4

### Juego de vasos de 1/2" y llaves combinadas



### S350AF

110 x 371 x 313 mm € 198,34 2 S350AF

### Juego de 10 vasos con punta 1/2", mm



### 7809M/10

45 x 110 x 255 mm € 151,41 1 7809M/10

7809M-5, 7809M-6, 7809M-7, 7809M-8,  
7809M-9, 7809M-10, 7809M-12, 7809M-14,  
7809M-17, 7809M-19

### Juego de 10 vasos con punta 1/2", pulgadas



### 7809Z/10

45 x 110 x 255 mm € 146,35 1 7809Z/10

7809Z-3/8, 7809Z-5/16, 7809Z-7/16,  
7809Z-1/4, 7809Z-19/32, 7809Z-5/8,  
7809Z-17/32, 7809Z-9/16, 7809Z-1/2,  
7809Z-3/16

### Juego de 10 vasos con puntas TORX® y HEXAGONALES 1/2"



### 7809TORX/10

45 x 110 x 255 mm € 165,64 1 7809TORX/10

7809TORX-T20, 7809TORX-T27,  
7809TORX-T25, 7809TORX-T40,  
7809TORX-T30, 7809TORX-T45,  
7809TORX-T50, 7809TORX-T55

7809M-6, 7809M-8

### Juego de vasos con cuadrado de 1/4" y 1/2" con perfil bi-hexagonal métrico - 42 piezas



### 7842MH

77 x 257 x 357 mm € 190,55 1 7842MH

8150MH

8160-10

7772H

7800DM-10, 7800DM-11, 7800DM-12,  
7800DM-13, 7800DM-15, 7800DM-17,  
7800DM-19, 7800DM-22, 7800DM-24,  
7800DM-27

6950MHS

6956MH

6973A

6960-6

A6700DM-5, A6700DM-5.5,  
A6700DM-6, A6700DM-7, A6700DM-8,  
A6700DM-9, A6700DM-10,  
A6700DM-11, A6700DM-12,  
A6700DM-13

59S/PZ1, 59S/PZ2

59S/PH1, 59S/PH2

59S/H4, 59S/H6, 59S/H8-3P, 59S/H10

59S/T10, 59S/T15, 59S/T20, 59S/T25,  
59S/T30

59S/0.5-4.0, 59S/1.2-8.0



Juego de Vasos de 1/4" y 1/2" con perfil métrico Bi-Hex y carraca con mango metálico - 56 piezas



### S560MH

100 x 215 x 375 mm € 180,77 4 S560MH

8150MH	
7800DM-10, 7800DM-11, 7800DM-12, 7800DM-13, 7800DM-14, 7800DM-15, 7800DM-17, 7800DM-19, 7800DM-22, 7800DM-24, 7800DM-27, 7800DM-30, 7800DM-32	
8160-5	
8166	
8174A	
7772H	
7805GPR-21	
8178	
6950MH	
6960,6962,6960-6	
6960-4	
6966	
6954-5	
6956MH	
6973A	
KM653-1P	
A6700DM-5, A6700DM-5.5, A6700DM-6, A6700DM-7, A6700DM-8, A6700DM-9, A6700DM-10, A6700DM-11, A6700DM-12, A6700DM-13	
A6800DM-4, A6800DM-5, A6800DM-6, A6800DM-7, A6800DM-8, A6800DM-9, A6800DM-10, A6800DM-11, A6800DM-12, A6800DM-13	
70S/T45, 70S/T50, 70S/T55	
1995M-1.5, 1995M-2, 1995M-2.5	

Juego de vasos 1/2", 14 piezas



### 7814DS

60 x 185 x 445 mm € 231,88 1 7814DS

7800DM-10, 7800DM-11, 7800DM-12, 7800DM-13, 7800DM-14, 7800DM-15, 7800DM-16, 7800DM-17, 7800DM-18, 7800DM-19

8150SL

8160-5, 8160-10

8166

Juego de vasos 1/2", 18 piezas



### 7818DS

60 x 185 x 445 mm € 281,77 1 7818DS

7800DM-8, 7800DM-10, 7800DM-11, 7800DM-12, 7800DM-13, 7800DM-14, 7800DM-15, 7800DM-16, 7800DM-17, 7800DM-18, 7800DM-19, 7800DM-21, 7800DM-22

8150SL

8160-5, 8160-10

8154-11

8166

Juego de vasos 1/2", 17 piezas



### 7818MHR

50 x 185 x 445 mm € 283,02 1 7818MHR

7800SM-10, 7800SM-11, 7800SM-12, 7800SM-13, 7800SM-14, 7800SM-15, 7800SM-17, 7800SM-19, 7800SM-22, 7800SM-24, 7800SM-27, 7800SM-30, 7800SM-32

8150RN-1/2

8160-5, 8160-10

8154-11

8166

Juego de vasos 1/2", 25 piezas



### 7825MHP

60 x 185 x 445 mm € 338,66 1 7825MHP

7800SM-10, 7800SM-11, 7800SM-12, 7800SM-13, 7800SM-14, 7800SM-15, 7800SM-16, 7800SM-17, 7800SM-18, 7800SM-19, 7800SM-20, 7800SM-21, 7800SM-22, 7800SM-23, 7800SM-24, 7800SM-26, 7800SM-27, 7800SM-28, 7800SM-30, 7800SM-32

8150-1/2

8160-5, 8160-10

8154-11

8166

4750BMC10

Juego de vasos 1/2", 26 piezas



### 7825MBP

60 x 185 x 445 mm € 338,74 1 7825MBP

7800DM-10, 7800DM-11, 7800DM-12, 7800DM-13, 7800DM-14, 7800DM-15, 7800DM-16, 7800DM-17, 7800DM-18, 7800DM-19, 7800DM-20, 7800DM-21, 7800DM-22, 7800DM-23, 7800DM-24, 7800DM-26, 7800DM-27, 7800DM-28, 7800DM-30, 7800DM-32

8150-1/2

8160-5, 8160-10

8154-11

8166

Juego de vasos 1/2", 25 piezas



**7819DRN**

51 x 225 x 445 mm € 370,14 1 7819DRN

- 7800DM-19, 7800DM-18, 7800DM-17, 7800DM-16, 7800DM-23, 7800DM-22, 7800DM-21, 7800DM-11, 7800DM-10, 7800DM-15, 7800DM-13, 7800DM-14, 7800DM-12, 7800DM-24, 7800DM-26, 7800DM-27, 7800DM-28, 7800DM-30, 7800DM-32
- 8150RN-1/2
- 8152-1/2
- 8166
- 8160-5, 8160-10
- 8154-11
- 8166
- 4750BMC10

Juego de vasos 1/2", 25 piezas



**7888DM**

73 x 340 x 445 mm € 379,84 1 7888DM

- 7800DM-10, 7800DM-11, 7800DM-12, 7800DM-13, 7800DM-14, 7800DM-15, 7800DM-16, 7800DM-17, 7800DM-18, 7800DM-19, 7800DM-20, 7800DM-21, 7800DM-22, 7800DM-23, 7800DM-24, 7800DM-26, 7800DM-27, 7800DM-28, 7800DM-30, 7800DM-32
- 8150-1/2
- 8154-11
- 8160-3, 8160-5, 8160-10
- 8166
- 8157-15

Juego de vasos 1/4" y 1/2", 47 piezas



**7847SS**

60 x 225 x 445 mm € 582,66 1 7847SS

- 6700SM-5, 6700SM-6, 6700SM-7, 6700SM-8, 6700SM-9, 6700SM-10, 6700SM-11, 6700SM-12, 6700SM-13
- 6950SL
- 6960, 6962, 6960-6
- 6954-5
- 6966
- 6956
- 59S/PH1, 59S/PH2, 59S/PH3
- 59S/PZ1, 59S/PZ2, 59S/PZ3
- 59S/0.6-4.5, 59S/0.8-5.5, 59S/1.2-8.0
- 59S/H3, 59S/H4, 59S/H5, 59S/H6
- 7800SM-10, 7800SM-11, 7800SM-12, 7800SM-13, 7800SM-14, 7800SM-15, 7800SM-17, 7800SM-19, 7800SM-22, 7800SM-24, 7800SM-27, 7800SM-30, 7800SM-32
- 8150SL
- 6973A
- 8160-5, 8160-10
- 8154-11
- 8166

Juego de vasos 1/2", pulgadas, 17 piezas



**7817DZS**

60 x 185 x 445 mm € 271,93 1 7817DZS

- 7800DZ-3/8, 7800DZ-7/16, 7800DZ-1/2, 7800DZ-9/16, 7800DZ-5/8, 7800DZ-11/16, 7800DZ-3/4, 7800DZ-13/16, 7800DZ-7/8, 7800DZ-15/16, 7800DZ-1, 7800DZ-1.1/8, 7800DZ-1.1/4

- 8150SL
- 8160-5, 8160-10
- 8166

Juego de vasos y puntas 1/2", 16 piezas



**7817DZS1**

60 x 185 x 445 mm € 218,94 1 7817DZS1

- 7800DZ-3/8, 7800DZ-7/16, 7800DZ-1/2, 7800DZ-9/16, 7800DZ-5/8, 7800DZ-11/16, 7800DZ-3/4, 7800DZ-13/16, 7800DZ-7/8, 7800DZ-15/16, 7800DZ-1, 7800DZ-1.1/8, 7800DZ-1.1/16

- 8150SL
- 8160-5, 8160-10
- 8166

Juego de vasos 1/2", AF, 23 piezas



**7823DZS**

60 x 185 x 445 mm € 320,26 1 7823DZS

- 7800DZ-3/8, 7800DZ-7/16, 7800DZ-1/2, 7800DZ-9/16, 7800DZ-19/32, 7800DZ-5/8, 7800DZ-11/16, 7800DZ-3/4, 7800DZ-25/32, 7800DZ-13/16, 7800DZ-7/8, 7800DZ-15/16, 7800DZ-1, 7800DZ-1.1/16, 7800DZ-1.1/8, 7800DZ-1.3/16, 7800DZ-1.1/4, 7800DZ-1.5/16

- 8150SL
- 8160-5, 8160-10
- 8154-11
- 8166





Juego de vasos 1/2", 14 piezas



**7814DST**

60 x 220 x 480 mm € 200,35 1 7814DST\*

- 7800DM-10, 7800DM-11, 7800DM-12, 7800DM-13, 7800DM-14, 7800DM-15, 7800DM-16, 7800DM-17, 7800DM-18, 7800DM-19
- 8150SL
- 8160-5, 8160-10
- 8166

Juego de vasos 1/2", 18 piezas



**7818DST**

60 x 220 x 480 mm € 251,14 1 7818DST

- 7800DM-8, 7800DM-10, 7800DM-11, 7800DM-12, 7800DM-13, 7800DM-14, 7800DM-15, 7800DM-16, 7800DM-17, 7800DM-18, 7800DM-19, 7800DM-21, 7800DM-22
- 8150SL
- 8160-5, 8160-10
- 8166
- 8154-11

Juego de vasos 1/2", 25 piezas



**7825SST**

65 x 250 x 480 mm € 316,64 1 7825SST

- 7800SM-10, 7800SM-11, 7800SM-12, 7800SM-13, 7800SM-14, 7800SM-15, 7800SM-16, 7800SM-17, 7800SM-18, 7800SM-19, 7800SM-20, 7800SM-21, 7800SM-22, 7800SM-23, 7800SM-24, 7800SM-26, 7800SM-27, 7800SM-28, 7800SM-30, 7800SM-32
- 8150SL
- 8160-1/2, 8162-1/2, 8166-1/2, 8154-1/2
- 8160-5, 8160-10
- 8166
- 8154-11

Juego de vasos 1/2", 18 piezas



**7818SST**

60 x 220 x 480 mm € 262,59 1 7818SST\*

- 7800SM-10, 7800SM-11, 7800SM-12, 7800SM-13, 7800SM-14, 7800SM-15, 7800SM-17, 7800SM-19, 7800SM-22, 7800SM-24, 7800SM-27, 7800SM-30, 7800SM-32
- 8150SL
- 8160-1/2, 8162-1/2, 8166-1/2, 8154-1/2
- 8160-5, 8160-10
- 8166
- 8154-11

Juego de vasos 1/2", 25 piezas



**7825DST**

65 x 250 x 480 mm € 316,64 1 7825DST\*

- 7800DM-10, 7800DM-11, 7800DM-12, 7800DM-13, 7800DM-14, 7800DM-15, 7800DM-16, 7800DM-17, 7800DM-18, 7800DM-19, 7800DM-20, 7800DM-21, 7800DM-22, 7800DM-23, 7800DM-24, 7800DM-26, 7800DM-27, 7800DM-28
- 8150SL
- 8160-1/2, 8162-1/2, 8166-1/2, 8154-1/2
- 8160-5, 8160-10
- 8166
- 8154-11

Juego de 10 vasos 1/2" en rail, mm



**7810MH**

10 g € 78,04 1 7810MH

- 7800SM-10, 7800SM-11, 7800SM-13, 7800SM-14, 7800SM-15, 7800SM-16, 7800SM-19, 7800SM-17, 7800SM-21, 7800SM-22

Juego de 10 vasos 1/2"



**7810MB**

10 € 78,04 1 7810MB

7800DM-11, 7800DM-10, 7800DM-14,  
7800DM-13, 7800DM-16, 7800DM-17,  
7800DM-19, 7800DM-22, 7800DM-21,  
7800DM-15

Juego de 6 vasos 1/2" en rail, mm



### 7806MD

		€		
6	950 g	106,72	1	7806MD

7805DM-10, 7805DM-14, 7805DM-13,  
7805DM-17, 7805DM-19, 7805DM-22

Juego de 6 vasos 1/2" en rail



### 7807TE

		€		
7	600 g	75,17	1	7807TE

7800TORX-E10, 7800TORX-E12,  
7800TORX-E14, 7800TORX-E16,  
7800TORX-E18, 7800TORX-E20,  
7800TORX-E24

Juego de vasos de 3/4", 17 piezas



### SLX 17

	€		
375 x 430 x 110 mm	277,96	1	SLX 17

12 vasos hex 22-50, Cabeza carraca 24d-S91, Mango ext S93, Cuadrado mango corr, Alarg 200, Alarg 400

Juego de llaves de vaso cuadradas de 3/4" con perfil hexagonal métrico y cabeza de carraca - 20 piezas



### SLX20

	€		
375 x 430 x 110 mm	279,13	2	SLX20

8900SM-19, 8900SM-22, 8900SM-24,  
8900SM-27, 8900SM-30, 8900SM-32,  
8900SM-33, 8900SM-34, 8900SM-36,  
8900SM-38, 8900SM-41, 8900SM-46,  
8900SM-50

8960-8, 8960-16

8954A

8950RN/A

8953-16

8966

8957A

Juego de vasos hex 3/4", 17 piezas, en pulgadas



### SLX17AF

	€		
70 x 375 x 430 mm	277,96	1	SLX 17AF

12 vasos hex, Cabeza carraca 24d-S91, Mango ext S93, Cuadrado mango corr, Alarg 8", Alarg 16"

Juego de vasos hex 3/4", 15 piezas, mm



### 8845NM

	€		
94 x 206 x 591 mm	601,25	1	8845NM

Este producto no está garantizado contra la rotura del cuadrado macho.

8900SM-24, 8900SM-22, 8900SM-27,  
8900SM-30, 8900SM-32, 8900SM-36,  
8900SM-38, 8900SM-41, 8900SM-46,  
8900SM-50

8953

8954A

8962, 8961

8950N/A, 8950RN/A

8955N/B

8960-16, 8960-8

\* Hasta agotar existencias





Juego de vasos 3/4", 15 piezas



**8845DM**

94 x 206 x 591 mm € 591,83 1 8845DM

8900DM-19, 8900DM-22, 8900DM-24, 8900DM-27, 8900DM-30, 8900DM-32, 8900DM-36, 8900DM-41, 8900DM-46, 8900DM-50

8950N/A, 8950RN/A

8953

8954A

8961, 8962

8955N/B

8960-8, 8960-16

Juego de vasos 3/4", 24 piezas



**8840M**

100 x 210 x 595 mm € 1.241,00 1 8840M

8900DM-19, 8900DM-22, 8900DM-24, 8900DM-25, 8900DM-27, 8900DM-28, 8900DM-30, 8900DM-32, 8900DM-36, 8900DM-41, 8900DM-46, 8900DM-50, 8900DM-55, 8900DM-60

8953

8950N/A, 8950RN/A

8951

8954A

8958A

8962, 8961

8966

8965, 8971

8172

8955N/B

8957A

8960-16, 8960-8

Juego de vasos 1", mm



**9540MB**

210 x 560 x 120 mm € 1.189,37 1 9540MB

9500SM-80, 9500SM-75, 9500SM-70, 9500SM-65, 9500SM-60, 9500SM-55, 9500SM-50, 9500SM-46

9550AB

9555

9560AB, 9563AB

Juego de vasos 1", mm, 18 piezas



**9540MBL**

225 x 605 x 120 mm € 1.758,73 1 9540MBL

9500SM-80, 9500SM-77, 9500SM-71, 9500SM-70, 9500SM-67, 9500SM-65, 9500SM-63, 9500SM-60, 9500SM-75, 9500SM-46, 9500SM-50, 9500SM-54, 9500SM-55, 9500SM-58

9550AB

9560AB, 9563AB

9555

Juego de 12 vasos bi-hexagonal 1", en pulgadas



**9540DZ**

150 x 260 x 670 mm € 1.398,81 1 9540DZ

9550AB

9555

9563AB, 9560AB

9500DZ-2.3/4, 9500DZ-2.3/8, 9500DZ-2.3/16, 9500DZ-3, 9500DZ-1.13/16, 9500DZ-3.1/8, 9500DZ-2.5/8, 9500DZ-2

Juego de vasos 3/4", 23 piezas



**8821MB**

95 x 220 x 600 mm € 852,99 1 8821MB

8950N/A, 8950RN/A

8954, 8954-15

8965, 8971

8966

8961, 8962

8900DM-26, 8900DM-23, 8900DM-22, 8900DM-24, 8900DM-27, 8900DM-29, 8900DM-28, 8900DM-32, 8900DM-30, 8900DM-34, 8900DM-38, 8900DM-35, 8900DM-36, 8900DM-46, 8900DM-41, 8900DM-42, 8900DM-50

8960-8, 8960-16

Juego de 19 vasos bi-hexagonal 1", en pulgadas



### 9540DZL

€	Icon	Icon
140 x 285 x 630 mm	1.914,71	1 9540DZL

9500DZ-2.1/4, 9500DZ-2.3/4, 9500DZ-2.3/8, 9500DZ-2.1/2, 9500DZ-2.15/16, 9500DZ-2.1/8, 9500DZ-1.7/8, 9500DZ-2.3/16, 9500DZ-3, 9500DZ-1.13/16, 9500DZ-3.1/8, 9500DZ-2.5/8, 9500DZ-2, 9500DZ-2.9/16

9550AB	
9555	
9563AB, 9560AB	
9565AB	

1/4"

Vaso 1/4", hexagonal, mm



### 6700SM

€	Icon	Icon
4 mm	5,28	5 6700SM-4
4.5 mm	5,28	5 6700SM-4.5
5 mm	5,28	5 6700SM-5
5.5 mm	5,28	5 6700SM-5.5
6 mm	5,28	5 6700SM-6
7 mm	5,28	5 6700SM-7
8 mm	5,28	5 6700SM-8
9 mm	5,28	5 6700SM-9
10 mm	5,28	5 6700SM-10
11 mm	5,28	5 6700SM-11
12 mm	5,28	5 6700SM-12
13 mm	5,28	5 6700SM-13
14 mm	5,28	5 6700SM-14
4 mm	6,02	1 SB6700SM-4
4.5 mm	6,02	1 SB6700SM-4.5
5 mm	6,02	1 SB6700SM-5
5.5 mm	6,02	1 SB6700SM-5.5
6 mm	6,02	1 SB6700SM-6
7 mm	6,02	1 SB6700SM-7
8 mm	6,02	1 SB6700SM-8
9 mm	6,02	1 SB6700SM-9

€	Icon	Icon
10 mm	6,02	1 SB6700SM-10
11 mm	6,02	1 SB6700SM-11
12 mm	6,02	1 SB6700SM-12
13 mm	6,02	1 SB6700SM-13
14 mm	6,02	1 SB6700SM-14

SB: Embalaje en blíster con información del producto

Vaso, hexagonal 1/4", pulgadas



### 6700SZ

€	Icon	Icon
1/8 in	5,37	5 6700SZ-1/8
5/32 in	5,37	5 6700SZ-5/32
3/16 in	5,37	5 6700SZ-3/16
7/32 in	5,37	5 6700SZ-7/32
1/4 in	5,37	5 6700SZ-1/4
9/32 in	5,37	5 6700SZ-9/32
5/16 in	5,37	5 6700SZ-5/16
11/32 in	5,37	5 6700SZ-11/32
3/8 in	5,37	5 6700SZ-3/8
7/16 in	5,37	5 6700SZ-7/16
1/2 in	5,37	5 6700SZ-1/2
9/16 in	5,37	5 6700SZ-9/16
1/8 in	6,07	5 SB6700SZ-1/8
5/32 in	6,07	1 SB6700SZ-5/32
3/16 in	6,07	1 SB6700SZ-3/16
7/32 in	6,07	1 SB6700SZ-7/32
1/4 in	6,07	1 SB6700SZ-1/4
5/16 in	6,07	1 SB6700SZ-5/16
11/32 in	6,07	1 SB6700SZ-11/32
3/8 in	6,07	1 SB6700SZ-3/8
7/16 in	6,07	1 SB6700SZ-7/16
1/2 in	6,07	1 SB6700SZ-1/2
9/16 in	6,07	1 SB6700SZ-9/16

SB: Embalaje en blíster con información del producto

Vaso TORX® hembra 1/4"



### 6700TORX-E

€	Icon	Icon
E4	7,08	5 6700TORX-E4
E5	7,08	5 6700TORX-E5
E6	7,08	5 6700TORX-E6

€	Icon	Icon
E7	7,08	5 6700TORX-E7
E8	7,08	5 6700TORX-E8
E10	7,08	5 6700TORX-E10
E4	7,78	1 SB6700TORX-E4
E5	7,78	1 SB6700TORX-E5
E6	7,78	1 SB6700TORX-E6
E7	7,78	1 SB6700TORX-E7
E8	7,78	1 SB6700TORX-E8

SB: Embalaje en blíster con información del producto

Vasos para refrigeración



### R6810M

€	Icon	Icon
3.4 mm	11,91	5 R6810M-3,4
4 mm	11,91	5 R6810M-4
4.5 mm	11,91	5 R6810M-4.5
5 mm	12,16	5 R6810M-5
6 mm	12,16	5 R6810M-6
7 mm	12,43	1 R6810M-7
8 mm	13,13	5 R6810M-8
9 mm	13,13	5 R6810M-9
10 mm	13,98	5 R6810M-10

Vasos para refrigeración, pulgadas



### R6810Z

€	Icon	Icon
3/16 in	12,17	1 R6810Z-3/16
7/32 in	12,17	1 R6810Z-7/32
1/4 in	12,17	1 R6810Z-1/4
5/16 in	14,81	1 R6810Z-5/16
3/8 in	14,81	1 R6810Z-3/8



Adaptador para refrigeración, 1/4"



**R6822Z**



€ 14,82 5 R6822Z

Adaptador de hembra a hembra, 1/4"



**R6967**



1/4 € 13,92 5 R6967

Adaptador de macho a macho, 1/4"



**R6964A**

€ 6,59 1 R6964A

Vaso bihexagonal 1/4" mm



**A6700DM**



Ø	€		
4 mm	4,89	5	A6700DM-4
4.5 mm	4,89	5	A6700DM-4.5
5 mm	5,28	5	A6700DM-5
5.5 mm	5,28	5	A6700DM-5.5
6 mm	5,28	5	A6700DM-6
7 mm	5,28	5	A6700DM-7
8 mm	5,28	5	A6700DM-8
9 mm	5,28	5	A6700DM-9
10 mm	5,28	5	A6700DM-10
11 mm	5,28	5	A6700DM-11
12 mm	5,28	5	A6700DM-12
13 mm	5,28	5	A6700DM-13
14 mm	5,28	5	A6700DM-14
5 mm	5,97	1	SBA6700DM-5
5.5 mm	5,97	1	SBA6700DM-5.5
6 mm	5,97	1	SBA6700DM-6
7 mm	5,97	1	SBA6700DM-7
8 mm	5,97	1	SBA6700DM-8
9 mm	5,97	1	SBA6700DM-9
10 mm	5,97	1	SBA6700DM-10
11 mm	5,97	1	SBA6700DM-11
12 mm	5,97	1	SBA6700DM-12
13 mm	5,97	1	SBA6700DM-13
14 mm	5,97	1	SBA6700DM-14

SB: Embalaje en blíster con información del producto

Vaso, bihexagonal 1/4" pulgadas



**A6700DZ**



Ø	€		
3/16 in	6,70	5	A6700DZ-3/16
7/32 in	6,70	5	A6700DZ-7/32
1/4 in	6,70	5	A6700DZ-1/4
9/32 in	6,70	5	A6700DZ-9/32
5/16 in	6,70	5	A6700DZ-5/16
11/32 in	6,70	5	A6700DZ-11/32
3/8 in	6,78	5	A6700DZ-3/8
7/16 in	6,78	5	A6700DZ-7/16
1/2 in	6,78	5	A6700DZ-1/2
9/16 in	6,78	5	A6700DZ-9/16

SB: Embalaje en blíster con información del producto

Vaso 1/4" Bihex serie larga, mm



**A6800DM**



Ø	€		
4 mm	12,41	1	A6800DM-4
5 mm	12,41	1	A6800DM-5
5.5 mm	12,41	1	A6800DM-5.5
6 mm	12,41	1	A6800DM-6
7 mm	12,41	1	A6800DM-7
8 mm	12,41	1	A6800DM-8
9 mm	12,41	1	A6800DM-9
10 mm	12,41	1	A6800DM-10
11 mm	12,41	1	A6800DM-11
12 mm	12,41	1	A6800DM-12
13 mm	12,41	1	A6800DM-13
14 mm	12,41	1	A6800DM-14
4 mm	13,11	1	SBA6800DM-4
5 mm	13,11	1	SBA6800DM-5
5.5 mm	13,11	1	SBA6800DM-5.5
6 mm	13,11	1	SBA6800DM-6
7 mm	13,11	1	SBA6800DM-7
8 mm	13,11	1	SBA6800DM-8
9 mm	13,11	1	SBA6800DM-9
10 mm	13,11	1	SBA6800DM-10
11 mm	13,11	1	SBA6800DM-11
12 mm	13,11	1	SBA6800DM-12
13 mm	13,11	1	SBA6800DM-13
14 mm	13,11	1	SBA6800DM-14

SB: Embalaje en blíster con información del producto

Vaso hexagonal largo 1/4"



**A6800SM**



Ø	€		
4 mm	12,23	1	A6800SM-4
4.5 mm	12,23	1	A6800SM-4.5
5 mm	12,23	1	A6800SM-5
6 mm	12,23	1	A6800SM-6
7 mm	12,23	1	A6800SM-7
8 mm	12,23	1	A6800SM-8
9 mm	12,23	1	A6800SM-9
10 mm	12,23	1	A6800SM-10
11 mm	12,23	1	A6800SM-11
12 mm	12,23	1	A6800SM-12
13 mm	12,23	1	A6800SM-13
14 mm	12,23	1	A6800SM-14
15 mm	12,23	1	A6800SM-15

SB: Embalaje en blíster con información del producto

Vaso 1/4" hexagonal, serie larga, en pulgadas



**A6800SZ**

	€		
1/8 in	15,72	1	A6800SZ-1/8*
5/32" in	15,72	1	A6800SZ-5/32*

Vaso 1/4" Bihex serie larga, pulgadas



**A6800DZ**

	€		
3/16 in	15,00	1	A6800DZ-3/16
7/32 in	15,00	1	A6800DZ-7/32
1/4 in	15,00	1	A6800DZ-1/4
9/32 in	15,00	1	A6800DZ-9/32
5/16 in	15,00	1	A6800DZ-5/16
11/32 in	15,00	1	A6800DZ-11/32
3/8 in	15,00	1	A6800DZ-3/8
7/16 in	15,00	1	A6800DZ-7/16
1/2 in	15,00	1	A6800DZ-1/2
9/16 in	15,00	1	A6800DZ-9/16
3/16 in	15,69	1	SBA6800DZ-3/16
7/32 in	15,69	1	SBA6800DZ-7/32
1/4 in	15,69	1	SBA6800DZ-1/4
9/32 in	15,69	1	SBA6800DZ-9/32
5/16 in	15,69	1	SBA6800DZ-5/16
11/32 in	15,69	1	SBA6800DZ-11/32
3/8 in	15,69	1	SBA6800DZ-3/8
7/16 in	15,69	1	SBA6800DZ-7/16
1/2 in	15,69	1	SBA6800DZ-1/2
9/16 in	15,69	1	SBA6800DZ-9/16

SB: Embalaje en blíster con información del producto

Vaso articulado 1/4", bihexagonal, mm



**A6710DM**

	€		
5.5 mm	42,83	1	A6710DM-5.5
6 mm	42,83	1	A6710DM-6
7 mm	42,83	1	A6710DM-7
8 mm	42,83	1	A6710DM-8
9 mm	42,83	1	A6710DM-9
10 mm	42,83	1	A6710DM-10
11 mm	43,52	1	A6710DM-11
12 mm	43,52	1	A6710DM-12
13 mm	43,52	1	A6710DM-13
14 mm	43,52	1	A6710DM-14

Vaso articulado, cuadrado 1/4"



**A6710DZ**

	€		
3/16 in	43,52	1	A6710DZ-3/16
7/32 in	43,52	1	A6710DZ-7/32
1/4 in	43,52	1	A6710DZ-1/4
9/32 in	43,52	1	A6710DZ-9/32
5/16 in	43,52	1	A6710DZ-5/16
11/32 in	43,52	1	A6710DZ-11/32
3/8 in	43,52	1	A6710DZ-3/8
7/16 in	43,76	1	A6710DZ-7/16
1/2 in	43,76	1	A6710DZ-1/2
9/16 in	43,76	1	A6710DZ-9/16

Mango articulado, 1/4"



**6958**

	€		
153 mm	22,23	1	6958-6
153 mm	44,34	1	SB6958-6

SB: Embalaje en blíster con información del producto

Mango articulado 1/4" con cabeza giratoria y mango metálico



**6957-6**

	€		
150 mm	8,55	10	6957-6

Mango corredizo en T de 1/4"



**6954**

	€		
125 mm	11,98	10	6954-5
125 mm	12,68	1	SB6954-5

SB: Embalaje en blíster con información del producto

Destornillador portavasos 1/4"



**6956**

	€		
150 mm	12,38	10	6956
150 mm	13,08	1	SB6956

SB: Embalaje en blíster con información del producto

Mango giratorio de 1/4" con mango metálico



**6956MH**

	€		
150 mm	12,57	10	6956MH

\* Hasta agotar existencias





### Alargadera 1/4"



#### 6960 - 6962L

L	€		
26 mm	7,94	1	696EX-01
75 mm	9,55	10	6960-3
150 mm	2,71	10	6960-6
152 mm	9,58	1	696EX-06*
276 mm	14,56	1	696EX-11
355 mm	16,97	1	6960-14
75 mm	12,60	1	SB6960-3
101 mm	12,18	1	SB6961*
150	14,35	1	SB6960-6
355 mm	17,49	1	SB6960-14

SB: Clip para colgar (blister)

### Alargadera angular de 1/4"



#### 6960-W - 6962-W

L	€		
50 mm	11,35	10	6960W-2
100 mm	13,25	1	6960W-4
150 mm	15,14	10	6960W-6

### Alargadera flexible de 1/4"



#### 6960F

L	€		
150 mm	7,96	1	SB6960F-6
150 mm	10,16	20	6960F-6

SB: Clip para colgar (blister)

### Articulación universal de 1/4"



#### 6966

L	€		
35 mm	24,34	10	6966
35 mm	25,04	1	SB6966

SB: Embalaje en blister con información del producto

### Articulación universal de 1/4", funcionamiento fluido



#### 6968

L	€		
35 mm	30,99	100	6968

### Adaptador 1/4" para puntas 1/4"



#### 6709HL

	€		
1/4 in	9,99	100	6709HL

### Adaptador portapuntas hexagonal 1/4"



#### 6972H

	€		
1/4" in	23,27	1	6972H

### Adaptador 1/4" para puntas 1/4"



#### 6973M

	€		
1/4"	6,89	1	6973M

### Adaptador 1/4" para puntas 1/4"



#### 6973A

	€		
1/4 in	7,51	10	6973A
1/4 in	6,03	1	SB6973A

SB: Embalaje en blister con información del producto



Adaptadores planos de 1/4" a 1/4"



**6969**

	€		
1/4	1,38	1	6969

Regleta para vasos



**RAIL-187/264/340**

L	€		
203 mm	2,66	10	RAIL-8
250 mm	2,93	10	RAIL-10
340 mm	3,31	3	RAIL-340*

Vasos con puntas Phillips 1/4"



**6709PH**

	€		
1	7,67	5	6709PH-1
2	7,67	5	6709PH-2
3	7,67	5	6709PH-3
4	7,67	5	6709PH-4
1	8,38	1	SB6709PH-1
2	8,38	1	SB6709PH-2
3	8,38	1	SB6709PH-3

SB: Embalaje en blíster con información del producto

Aumentador plano de entrada 1/4" a salida 3/8"



**7767**

	€		
1/4	24,90	1	7767
1/4	25,60	1	SB7767

SB: Embalaje en blíster con información del producto

Clips 1/4"



**C1/4**

L	€		
17 mm	0,38	25	CLIPS-1/4

Vasos con puntas Pozidriv 1/4"



**6709PZ**

	€		
1	8,15	5	6709PZ-1
2	8,15	5	6709PZ-2
3	8,15	5	6709PZ-3
1	8,84	1	SB6709PZ-1
2	8,84	1	SB6709PZ-2
3	8,84	1	SB6709PZ-3

SB: Embalaje en blíster con información del producto

Juego de aumentadores planos 7767,8167,8967



**8967/S3**

	€		
110 x 194 x 30 mm	87,69	1	8967/S3

7767	
8167	
8967	

Vasos con puntas recta 1/4"



**6709F**

		€		
0.6 mm	4.5 mm	7,01	5	6709F-4.5
0.8 mm	5.5 mm	7,01	5	6709F-5.5
0.9 mm	6.5 mm	7,01	5	6709F-6.5
1.2 mm	8 mm	7,01	5	6709F-8
0.8 mm	5.5 mm	7,74	1	SB6709F-5.5
1.2 mm	8 mm	7,74	1	SB6709F-8

SB: Embalaje en blíster con información del producto

\* Hasta agotar existencias



Vasos con punta TORX® 1/4"



**6709TORX**

	€		
T6	8,33	5	6709TORX-T6
T7	8,33	5	6709TORX-T7
T8	8,64	5	6709TORX-T8
T9	8,64	5	6709TORX-T9
T10	8,64	5	6709TORX-T10
T15	8,64	5	6709TORX-T15
T20	8,64	5	6709TORX-T20
T25	8,93	5	6709TORX-T25
T27	8,93	5	6709TORX-T27
T30	8,93	5	6709TORX-T30
T40	8,93	5	6709TORX-T40
T8	9,34	1	SB6709TORX-T8
T9	9,34	1	SB6709TORX-T9
T10	9,34	1	SB6709TORX-T10
T15	9,34	1	SB6709TORX-T15
T20	9,34	1	SB6709TORX-T20
T25	9,61	1	SB6709TORX-T25
T27	9,61	1	SB6709TORX-T27
T30	9,61	1	SB6709TORX-T30
T40	9,61	1	SB6709TORX-T40

SB: Embalaje en blister con información del producto

Vasos con puntas TORX® inviolable 1/4"



**6709TORX-R**

	€		
TR 8	9,05	1	6709TORX-R-T8
TR 10	9,05	1	6709TORX-R-T10
TR 15	9,05	1	6709TORX-R-T15
TR 20	9,05	1	6709TORX-R-T20
TR 25	9,38	1	6709TORX-R-T25
TR 8	9,74	1	SB6709TORX-R-T8*
TR 10	9,74	1	SB6709TORX-R-T10*
TR 15	9,74	1	SB6709TORX-R-T15*
TR 20	9,74	1	SB6709TORX-R-T20*
TR 25	10,08	1	SB6709TORX-R-T25*

SB: Embalaje en blister con información del producto

Vaso cuadradillo 1/4" con puntas TORX PLUS® 1/4"



**6709-IP**

	€		
IP6	8,64	1	6709-IP6
IP7	8,64	1	6709-IP7
IP8	8,97	1	6709-IP8
IP9	8,97	1	6709-IP9
IP10	M3 9,03	1	6709-IP10
IP15	- 9,03	1	6709-IP15
IP20	M4 9,03	1	6709-IP20
IP25	M5 9,37	1	6709-IP25
IP27	- 9,03	1	6709-IP27
IP30	M6 8,64	1	6709-IP30
IP40	M8 10,77	1	6709-IP40
IP45	- 10,77	1	6709-IP45

Vasos con puntas hexagonales 1/4"



**6709M**

	€		
3 mm	6,94	5	6709M-3
4 mm	6,94	5	6709M-4
5 mm	6,94	5	6709M-5
6 mm	6,94	5	6709M-6
8 mm	6,94	5	6709M-8
10 mm	6,93	5	6709M-10
4 mm	7,63	1	SB6709M-4
5 mm	7,63	1	SB6709M-5
6 mm	7,63	1	SB6709M-6
8 mm	7,63	1	SB6709M-8

SB: Embalaje en blister con información del producto

Vaso con punta hex 1/4" serie larga, mm



**A6709M**

	€		
2.5 mm	32,90	1	A6709M-2.5
3 mm	32,90	1	A6709M-3
4 mm	32,90	1	A6709M-4
5 mm	32,90	1	A6709M-5
6 mm	32,90	1	A6709M-6
2.5 mm	33,77	1	SBA6709M-2.5
3 mm	33,77	1	SBA6709M-3
4 mm	33,77	1	SBA6709M-4
5 mm	33,60	1	SBA6709M-5
6 mm	33,60	1	SBA6709M-6

SB: Embalaje en blister con información del producto

Vaso con punta hex 1/4" serie larga, pulgadas



**A6709Z**

	€		
1/8 in	32,90	1	A6709Z-1/8
9/64 in	32,90	1	A6709Z-9/64
5/32 in	32,90	1	A6709Z-5/32
3/16 in	32,90	1	A6709Z-3/16
1/8 in	33,60	1	SBA6709Z-1/8
9/64 in	33,60	1	SBA6709Z-9/64
5/32 in	33,60	1	SBA6709Z-5/32
3/16 in	33,60	1	SBA6709Z-3/16

SB: Embalaje en blister con información del producto

Llave de carraca 1/4" con bloqueo 72 dientes



**6950SL**

L	Dientes	€	Embalaje	Artículo
119 mm	72	42,45	1	6950SL

Cabeza reducida

Llave de carraca reversible para válvulas de refrigeración



**R6950**

L	Dientes	€	Embalaje	Artículo
160 mm	32	107,56	1	R6950

Llave de carraca reversible 1/4"



**6950QR**

L	Dientes	€	Embalaje	Artículo
145 mm	60	22,78	10	6950QR
145 mm	60	23,29	1	SB6950QR

SB: Embalaje en blister

Llave de carraca reversible 1/4" 72 dientes 5° ángulo de acción



**6950**

L	Dientes	€	Embalaje	Artículo
121 mm	72	42,04	1	6950
121 mm	72	42,79	1	SB6950

SB=embalaje en blister

Carraca de cabeza tipo pera reversible 1/4" con 60 dientes, mango metálico



**6950MH**

L	Dientes	€	Embalaje	Artículo
150 mm	60	13,95	10	6950MH
150 mm	60	14,46	1	SB6950MH

SB=embalaje en blister

Llave de carraca 1/4" reversible



**6950QRS**

L	Dientes	€	Embalaje	Artículo
120 m	60	22,81	10	6950QRS
120 m	60	23,33	1	SB6950QRS

SB: Embalaje en blister

Llave de carraca reversible, 1/4" 72 dientes/5° ángulo de acción



**6950RN**

L	Dientes	€	Embalaje	Artículo
121 mm	72	38,10	1	6950RN
121 mm	72	38,76	1	SB6950RN

SB=embalaje en blister

Carraca reversible corta de 1/4" con cabeza tipo pera, 60 dientes, mango metálico



**6950MHS**

L	Dientes	€	Embalaje	Artículo
120 mm	60	13,95	10	6950MHS
120	60	14,46	1	SB6950MHS

SB=embalaje en blister

Llave de carraca 1/4" con cabeza giratoria



**8120-1/4**

L	Dientes	€	Embalaje	Artículo
149 mm	72	39,49	20	8120-1/4

\* Hasta agotar existencias



Llaves combinadas de carraca para puntas de destornillador



**6950CBR**

	€		
52	11,72	10	6950CBR
52	12,24	1	SB6950CBR

SB=embalaje en blister

Adaptador para llave de carraca 1/4"



**6951**

	€		
40 mm	82,84	1	6951

60 dientes / Ángulo de acción de 6°

Kit de reparación para carraca 1/4" 6950SL



**6950SL-SPARE**

	€		
10	18,16	1	6950SL-SPARE

Kit de reparación para carraca 1/4" - 6950



**6950-SPARE**

	€		
12	6950	18,67	1 6950-SPARE

Kit de reparación para carraca 1/4 6950RN



**6950RN-SPARE**

	€		
6	6950RN	17,93	1 6950RN-SPARE

3/8"

Vaso hexagonal 3/8", mm



**7400SM**

	€		
6 mm	5,75	5	7400SM-6
7 mm	5,75	5	7400SM-7
8 mm	5,85	5	7400SM-8
9 mm	6,08	5	7400SM-9
10 mm	6,30	5	7400SM-10
11 mm	6,39	5	7400SM-11

	€		
12 mm	6,48	5	7400SM-12
13 mm	6,64	5	7400SM-13
14 mm	7,10	5	7400SM-14
15 mm	7,37	5	7400SM-15
16 mm	7,79	5	7400SM-16
17 mm	7,97	5	7400SM-17
18 mm	8,16	5	7400SM-18
19 mm	8,49	5	7400SM-19
20 mm	8,71	5	7400SM-20
21 mm	8,97	5	7400SM-21
22 mm	9,12	5	7400SM-22
6 mm	6,45	1	SB7400SM-6
7 mm	6,45	1	SB7400SM-7
8 mm	6,55	1	SB7400SM-8
9 mm	6,78	1	SB7400SM-9
10 mm	6,99	1	SB7400SM-10
11 mm	7,08	1	SB7400SM-11
12 mm	7,19	1	SB7400SM-12
13 mm	7,33	1	SB7400SM-13
14 mm	7,79	1	SB7400SM-14
15 mm	8,09	1	SB7400SM-15
16 mm	8,48	1	SB7400SM-16
17 mm	8,65	1	SB7400SM-17
18 mm	8,86	1	SB7400SM-18
19 mm	9,20	1	SB7400SM-19
20 mm	9,41	1	SB7400SM-20
21 mm	9,66	1	SB7400SM-21
22 mm	9,82	1	SB7400SM-22

SB: Embalaje en blister con información del producto

Vaso bihexagonal 3/8", mm



**A7400DM**

	€		
6 mm	7,66	5	A7400DM-6
7 mm	7,66	5	A7400DM-7
8 mm	7,66	5	A7400DM-8
9 mm	7,66	5	A7400DM-9
10 mm	7,66	5	A7400DM-10
11 mm	7,66	5	A7400DM-11
12 mm	7,66	5	A7400DM-12
13 mm	7,66	5	A7400DM-13
14 mm	7,66	5	A7400DM-14
15 mm	7,78	5	A7400DM-15
16 mm	7,78	5	A7400DM-16
17 mm	7,78	5	A7400DM-17
18 mm	7,78	5	A7400DM-18
19 mm	7,78	5	A7400DM-19
20 mm	7,78	5	A7400DM-20
21 mm	7,87	5	A7400DM-21
22 mm	7,87	5	A7400DM-22
24 mm	8,30	5	A7400DM-24
6 mm	8,35	1	SBA7400DM-6
7 mm	8,35	1	SBA7400DM-7

Ø	€		
8 mm	8,35	1	SBA7400DM-8
9 mm	8,35	1	SBA7400DM-9
10 mm	8,35	1	SBA7400DM-10
11 mm	8,35	1	SBA7400DM-11
12 mm	8,35	1	SBA7400DM-12
13 mm	8,35	1	SBA7400DM-13
14 mm	8,35	1	SBA7400DM-14
15 mm	8,47	1	SBA7400DM-15
16 mm	8,47	1	SBA7400DM-16
17 mm	8,47	1	SBA7400DM-17
18 mm	8,47	1	SBA7400DM-18
19 mm	8,47	1	SBA7400DM-19
20 mm	8,47	1	SBA7400DM-20
21 mm	8,56	1	SBA7400DM-21
22 mm	8,56	1	SBA7400DM-22

SB: Embalaje en blíster con información del producto

### Vaso hexagonal 3/8", pulgadas



### 7400SZ

Ø	€		
1/4" in	7,44	1	7400SZ-1/4
5/16" in	7,44	1	7400SZ-5/16
11/32" in	7,67	1	7400SZ-11/32
3/8" in	7,44	1	7400SZ-3/8
7/16" in	7,56	1	7400SZ-7/16
1/2" in	7,56	1	7400SZ-1/2
9/16" in	7,56	1	7400SZ-9/16
5/8" in	7,67	1	7400SZ-5/8
11/16" in	7,67	1	7400SZ-11/16
3/4" in	7,67	1	7400SZ-3/4
13/16" in	7,67	1	7400SZ-13/16
7/8" in	7,67	1	7400SZ-7/8

### Vaso bihexagonal 3/8", pulgadas



### A7400DZ

Ø	€		
1/4 in	8,34	5	A7400DZ-1/4
5/16 in	8,34	5	A7400DZ-5/16
3/8 in	8,34	5	A7400DZ-3/8

Ø	€		
7/16 in	8,49	5	A7400DZ-7/16
1/2 in	8,49	5	A7400DZ-1/2
17/32 in	8,49	5	A7400DZ-17/32
9/16 in	8,49	5	A7400DZ-9/16
19/32 in	8,49	5	A7400DZ-19/32
5/8 in	8,61	5	A7400DZ-5/8
11/16 in	8,61	5	A7400DZ-11/16
3/4 in	8,61	5	A7400DZ-3/4
13/16 in	8,61	5	A7400DZ-13/16
7/8 in	8,61	5	A7400DZ-7/8
1/4 in	9,05	1	SBA7400DZ-1/4
5/16 in	9,05	1	SBA7400DZ-5/16
3/8 in	9,05	1	SBA7400DZ-3/8
7/16 in	9,20	1	SBA7400DZ-7/16
1/2 in	9,20	1	SBA7400DZ-1/2
17/32 in	9,20	1	SBA7400DZ-17/32
9/16 in	9,20	1	SBA7400DZ-9/16
19/32 in	9,20	1	SBA7400DZ-19/32
5/8 in	9,31	1	SBA7400DZ-5/8
11/16 in	9,31	1	SBA7400DZ-11/16
3/4 in	9,31	1	SBA7400DZ-3/4
13/16 in	9,31	1	SBA7400DZ-13/16
7/8 in	9,31	1	SBA7400DZ-7/8

SB: Embalaje en blíster con información del producto

### Vasos articulados con cuadrado de 3/8" y con perfil bi-hexagonal métrico



### A7410DM

Ø	€		
10 mm	44,24	1	A7410DM-10
11 mm	44,24	1	A7410DM-11
12 mm	45,40	1	A7410DM-12
13 mm	45,40	1	A7410DM-13
14 mm	45,40	1	A7410DM-14
15 mm	45,99	1	A7410DM-15
16 mm	45,99	1	A7410DM-16
17 mm	48,90	1	A7410DM-17
18 mm	49,84	1	A7410DM-18
19 mm	49,84	1	A7410DM-19

### Vaso articulado bihexagonal 3/8", pulgadas



### A7410DZ

Ø	€		
5/16 in	40,59	1	A7410DZ-5/16
3/8 in	42,02	1	A7410DZ-3/8
7/16 in	42,02	1	A7410DZ-7/16
1/2 in	42,02	1	A7410DZ-1/2
9/16 in	42,02	1	A7410DZ-9/16
5/8 in	46,92	1	A7410DZ-5/8
11/16 in	46,92	1	A7410DZ-11/16
3/4 in	46,92	1	A7410DZ-3/4

### Vaso bihexagonal 3/8" serie larga, mm



### A7402DM

Ø	€		
7 mm	15,36	1	A7402DM-7
8 mm	15,36	1	A7402DM-8
9 mm	15,37	1	A7402DM-9
10 mm	15,37	5	A7402DM-10
11 mm	15,37	1	A7402DM-11
12 mm	15,37	1	A7402DM-12
13 mm	15,37	1	A7402DM-13
14 mm	16,08	1	A7402DM-14
15 mm	16,08	1	A7402DM-15
16 mm	16,08	1	A7402DM-16
17 mm	17,14	1	A7402DM-17
18 mm	17,14	1	A7402DM-18
19 mm	17,14	1	A7402DM-19
21 mm	17,53	1	A7402DM-21
7 mm	16,05	1	SBA7402DM-7
8 mm	16,05	1	SBA7402DM-8
9 mm	16,07	1	SBA7402DM-9
10 mm	16,07	1	SBA7402DM-10
11 mm	16,07	1	SBA7402DM-11
12 mm	16,07	1	SBA7402DM-12
13 mm	16,07	1	SBA7402DM-13
14 mm	16,76	1	SBA7402DM-14
15 mm	16,76	1	SBA7402DM-15
16 mm	16,76	1	SBA7402DM-16
17 mm	17,85	1	SBA7402DM-17
18 mm	17,85	1	SBA7402DM-18
19 mm	17,85	1	SBA7402DM-19

SB: Embalaje en blíster con información del producto





Llaves de vaso profundas de accionamiento cuadrado de 3/8" con perfil hexagonal métrico



### A7402SM

€	Icono	Icono
6 mm	15,36	10 A7402SM-6
7 mm	15,36	10 A7402SM-7
8 mm	15,36	10 A7402SM-8
9 mm	15,37	10 A7402SM-9
10 mm	15,37	1 A7402SM-10
11 mm	15,37	1 A7402SM-11
12 mm	15,37	10 A7402SM-12
13 mm	15,37	10 A7402SM-13
14 mm	16,08	10 A7402SM-14
15 mm	16,08	10 A7402SM-15
16 mm	16,08	10 A7402SM-16
17 mm	17,14	10 A7402SM-17
18 mm	17,14	10 A7402SM-18
19 mm	17,14	10 A7402SM-19
20 mm	18,68	10 A7402SM-20
22 mm	18,68	10 A7402SM-22

6	15,36	1 SBA7402SM-6
7	15,36	1 SBA7402SM-7
8	15,36	1 SBA7402SM-8
9	15,36	1 SBA7402SM-9
10	15,86	1 SBA7402SM-10
11	15,86	1 SBA7402SM-11
12	15,86	1 SBA7402SM-12
13	15,86	1 SBA7402SM-13
14	16,59	1 SBA7402SM-14
15	16,59	1 SBA7402SM-15
16	16,59	1 SBA7402SM-16
17	17,65	1 SBA7402SM-17
18	17,65	1 SBA7402SM-18
19	17,65	1 SBA7402SM-19
20	18,59	1 SBA7402SM-20
22	18,59	10 SBA7402SM-22

SB: Embalaje en blíster con información del producto

Vaso bihexagonal 3/8" serie larga, pulgadas



### A7402DZ

€	Icono	Icono
1/4 in	17,26	1 A7402DZ-1/4
5/16 in	17,26	1 A7402DZ-5/16
3/8 in	17,26	1 A7402DZ-3/8
7/16 in	17,26	1 A7402DZ-7/16
1/2 in	17,26	1 A7402DZ-1/2
9/16 in	17,26	1 A7402DZ-9/16
19/32 in	17,26	1 A7402DZ-19/32
5/8 in	17,26	1 A7402DZ-5/8
11/16 in	17,26	1 A7402DZ-11/16
3/4 in	17,26	1 A7402DZ-3/4

€	Icono	Icono
13/16 in	17,26	1 A7402DZ-13/16
7/8 in	17,26	1 A7402DZ-7/8
1/4 in	17,93	1 SBA7402DZ-1/4
5/16 in	17,93	1 SBA7402DZ-5/16
3/8 in	17,93	1 SBA7402DZ-3/8
7/16 in	17,93	1 SBA7402DZ-7/16
1/2 in	17,93	1 SBA7402DZ-1/2
9/16 in	17,93	1 SBA7402DZ-9/16
19/32 in	17,93	1 SBA7402DZ-19/32
5/8 in	17,93	1 SBA7402DZ-5/8
11/16 in	17,93	1 SBA7402DZ-11/16
3/4 in	17,93	1 SBA7402DZ-3/4
13/16 in	17,93	1 SBA7402DZ-13/16
7/8 in	17,93	1 SBA7402DZ-7/8

SB: Embalaje en blíster con información del producto

Vaso TORX® hembra 3/8"



### 7400TORX-E

€	Icono	Icono
E8	11,21	5 7400TORX-E8
E10	11,21	5 7400TORX-E10
E11	11,21	5 7400TORX-E11
E12	11,21	5 7400TORX-E12
E14	12,25	5 7400TORX-E14
E16	12,25	5 7400TORX-E16
E18	12,85	5 7400TORX-E18
E8	11,92	1 SB7400TORX-E8
E10	11,92	1 SB7400TORX-E10
E11	11,92	1 SB7400TORX-E11
E12	11,92	1 SB7400TORX-E12
E14	12,94	1 SB7400TORX-E14
E16	12,94	1 SB7400TORX-E16
E18	13,54	1 SB7400TORX-E18

SB: Embalaje en blíster con información del producto

Berbiquí 3/8" con mango de acero giratorio



### 7752

€	Icono	Icono
435 mm	48,27	1 7752

Mango articulado 3/8"



### 7758

€	Icono	Icono
250 m	29,90	1 7758-10
250 m	31,39	1 SB7758-10

SB: Embalaje en blíster con información del producto

Mango corredizo en T 3/8"



### 7754

€	Icono	Icono
200 mm	17,40	10 7754-8

SB: Embalaje en blíster con información del producto

Destornillador portavasos 3/8"



### 7756

€	Icono	Icono
150 mm	18,91	6 7756
150 mm	19,50	1 SB7756

SB: Clip para colgar

Mango giratorio de 3/8" con mango metálico



**7756MH**

L	€	SB	Icon	Part No.
150 mm	19,83	10	7756MH	

Alargadera de 3/8" con moleteado



**776EX**

L	€	SB	Icon	Part No.
26 mm	12,57	1	776EX-01*	
76 mm	12,57	1	776EX-03*	
101 mm	14,47	1	776EX-04*	
200 mm	16,38	1	776EX-08*	

Articulación universal 3/8", funcionamiento fluido



**7768**

L	€	SB	Icon	Part No.
45 mm	42,79	50	7768	

Alargadera de 3/8"



**7760-7761-7762**

L	€	SB	Icon	Part No.
75 mm	7,21	32	7760-3	
125 mm	13,79	10	7760-5	
252 mm	20,50	1	SB7762	

SB: Clip para colgar

Alargadera flexible de 3/8"

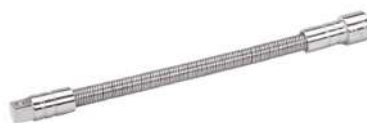

**7759**

L	€	SB	Icon	Part No.
200 mm	41,81	1	7759	
200 mm	42,51	1	SB7759	

SB: Clip para colgar

Reductor de entrada 3/8" y salida 1/4"



**7771**

Input	Output	€	SB	Icon	Part No.
3/8"	1/4"	13,05	5	7771	
3/8"	1/4"	13,36	1	SB7771	

Este producto no está garantizado contra la rotura del cuadrado macho

Alargadera angular 3/8"



**7760-W - 7761-W**

L	€	SB	Icon	Part No.
75 mm	11,53	10	7760W-3	
150 mm	12,81	10	7760W-6	

SB: Clip para colgar

Articulación universal 3/8"



**7766**

L	€	SB	Icon	Part No.
51.5 mm	30,22	1	7766	
51.5 mm	30,90	1	SB7766	

SB: Embalaje en blíster con información del producto

Amplificador de entrada 3/8" a salida 1/2"



**7772**

Input	Output	€	SB	Icon	Part No.
3/8"	1/2"	12,66	40	7772	

\* Hasta agotar existencias



Aumentador magnético de 3/8" a 1/2"



**8167**

		€		
3/8	1/2	29,20	1	8167

Railes y clips para vasos 3/8"



**C3/8**

	€		
19 mm	0,38	25	CLIPS-3/8

Llave de carraca reversible, 3/8"



**7750RN**

		€		
206 mm	72	54,02	1	7750RN
206 mm	72	54,73	1	SB7750RN

SB- Clip para colgar

Adaptador 3/8" para puntas 1/4"



**7773A**

	€		
1/4 in	3,08	20	7773A
1/4 in	2,39	1	SB7773A

SB=embalaje en blister

Llave de carraca 3/8" cabeza delgada 72 dientes



**7750SL**

		€		
204 mm	72	60,28	1	7750SL

Llave de carraca reversible 3/8", liberación rápida



**7750QR**

		€		
200 m	60	31,78	10	7750QR
200 m	60	32,29	1	SB7750QR

SB: Embalaje en blister

Adaptador 3/8" para puntas 5/16"



**7106J**

	€		
5/16 in	8,79	1	7106J*

Llave de carraca reversible 3/8"



**7750**

		€		
207 mm	80	57,00	1	7750
207 mm	80	60,71	1	SB7750

SB=embalaje en blister

Carraca de cabeza tipo pera reversible 3/8" con 60 dientes, mango metálico



**7750MH**

		€		
150	60	29,82	5	7750MH

Carraca 3/8" con cabeza giratoria



**8120-3/8**

		€		
223 mm	72	48,09	10	8120-3/8

Llave de carraca articulada 3/8" reversible



**7710**

		€		
278 mm	60	79,13	1	7710

Carraca pasante de 19 mm con 72 dientes y ángulo de acción de 5°.



**SBS19-THR**

		€		
250 mm	60	37,47	50	SBS19-THR

SB=embalaje en blister

Vaso con punta recta 3/8"



**7409F**

	€		
6.4 mm	6,74	5	7409F-6.5
7.9 mm	6,74	5	7409F-8
9.5 mm	6,74	5	7409F-10
6.4 mm	7,46	1	SB7409F-6.5
7.9 mm	7,46	1	SB7409F-8
9.5 mm	7,46	1	SB7409F-10

SB: Embalaje en blíster con información del producto

Vaso con punta Phillips 3/8"



**7409PH**

	€		
1	7,10	5	7409PH-1
2	7,10	5	7409PH-2
3	7,10	5	7409PH-3
1	7,79	1	SB7409PH-1
2	7,79	1	SB7409PH-2
3	7,79	1	SB7409PH-3

SB: Embalaje en blíster con información del producto

Vaso con punta TORX® 3/8"



**7409TORX**

	€		
T20	12,07	5	7409TORX-T20
T25	12,07	5	7409TORX-T25
T27	12,07	5	7409TORX-T27
T30	12,07	5	7409TORX-T30
T40	14,64	5	7409TORX-T40

	€		
T45	14,64	5	7409TORX-T45
T50	14,64	5	7409TORX-T50
T20	12,77	1	SB7409TORX-T20
T25	12,77	1	SB7409TORX-T25
T27	12,77	1	SB7409TORX-T27
T30	12,77	1	SB7409TORX-T30
T40	15,31	1	SB7409TORX-T40
T45	15,31	1	SB7409TORX-T45
T50	15,31	1	SB7409TORX-T50

SB: Embalaje en blíster con información del producto

Vaso con punta TORX® inviolable, 3/8"



**7409TORX-R**

	€		
TR 27	13,39	5	7409TORX-R-T27
TR 30	13,39	5	7409TORX-R-T30
TR 40	15,75	5	7409TORX-R-T40
TR 45	16,07	5	7409TORX-R-T45
TR 50	16,72	5	7409TORX-R-T50
TR 27	14,09	1	SB7409TORX-R-T27
TR 30	14,09	1	SB7409TORX-R-T30
TR 40	16,46	1	SB7409TORX-R-T40
TR 45	16,74	1	SB7409TORX-R-T45
TR 50	17,44	1	SB7409TORX-R-T50

SB: Embalaje en blíster con información del producto

Juego de 5 vasos con punta 3/8" 7409TORX



**7409TORX-TRR/**

		€		
5	25 x 55 x 190 mm	72,36	1	7409TORX-TRR/S5

7409TORX-R-T40, 7409TORX-R-T30, 7409TORX-R-T27, 7409TORX-R-T50, 7409TORX-R-T45

\* Hasta agotar existencias



Vaso con punta TORX® serie larga 3/8"



**7409TORX-L**

	€		
T25	19,62	5	7409TORX-T25-L
T30	19,62	5	7409TORX-T30-L
T40	22,95	5	7409TORX-T40-L
T45	22,95	5	7409TORX-T45-L
T50	22,95	5	7409TORX-T50-L
T30	20,32	1	SB7409TORX-T30-L*
T40	23,63	1	SB7409TORX-T40-L*
T45	23,63	1	SB7409TORX-T45-L*
T50	23,63	1	SB7409TORX-T50-L*

SB: Embalaje en blister con información del producto

Vaso con punta hexagonal cuadrado 3/8", mm



**7409M**

	€		
3 mm	10,94	5	7409M-3
4 mm	10,94	5	7409M-4
5 mm	10,94	5	7409M-5
6 mm	10,94	5	7409M-6
7 mm	10,94	5	7409M-7
8 mm	11,98	5	7409M-8
10 mm	11,98	5	7409M-10
3 mm	11,63	1	SB7409M-3
4 mm	11,63	1	SB7409M-4
5 mm	11,63	1	SB7409M-5
6 mm	11,63	1	SB7409M-6
7 mm	11,63	1	SB7409M-7
8 mm	12,66	1	SB7409M-8
10 mm	12,66	1	SB7409M-10

SB: Embalaje en blister con información del producto

Vaso con punta hexagonal con bola 3/8"



**7409BH**

	€		
4 mm	11,74	5	7409BH-4
5 mm	11,74	1	7409BH-5
6 mm	11,74	5	7409BH-6

	€		
8 mm	12,73	5	7409BH-8
10 mm	14,43	5	7409BH-10
4 mm	12,42	1	SB7409BH-4*
5 mm	12,42	1	SB7409BH-5*
6 mm	12,42	1	SB7409BH-6*
8 mm	13,42	1	SB7409BH-8*
10 mm	15,12	1	SB7409BH-10*

SB: Embalaje en blister con información del producto

Claves de vaso pasantes de 19 mm con perfil métrico



**SBS19-TH**

	€		
10 mm	5,87	1	SBS19-TH10
11 mm	5,87	1	SBS19-TH11
12 mm	5,87	1	SBS19-TH12
13 mm	5,87	1	SBS19-TH13
14 mm	6,06	1	SBS19-TH14
15 mm	6,06	1	SBS19-TH15
16 mm	6,06	1	SBS19-TH16
17 mm	6,92	1	SBS19-TH17
18 mm	6,92	1	SBS19-TH18
19 mm	6,92	1	SBS19-TH19
21 mm	7,61	1	SBS19-TH21
22 mm	7,61	1	SBS19-TH22
24 mm	8,19	1	SBS19-TH24

Portapuntas cuadradillos de 3/8", para puntas hexagonales, pulgadas



**7409Z**

	L	€		
1/8 in	47 mm	9,86	1	7409Z-1/8
5/32 in	47 mm	9,86	1	7409Z-5/32
3/16 in	47 mm	9,86	1	7409Z-3/16
7/32 in	47 mm	9,86	1	7409Z-7/32
1/4 in	47 mm	9,86	1	7409Z-1/4
3/8 in	50.5 mm	10,79	1	7409Z-3/8

Vaso pasante de 19 mm Extensión de 75 mm



**SBS19-TH75**

L	€		
75 mm	9,99	1	SBS19-TH75

SB=embalaje en blister

Juego de vasos con punta hexagonal 3/8"



**7409MR/**

	€		
7 25 x 55 x 190 mm	79,49	1	7409MR/S7

7409M-3, 7409M-4, 7409M-10, 7409M-8, 7409M-7, 7409M-6, 7409M-5

Adaptador de carraca reversible 3/8"



**7751**

L	g	€		
55 mm	175 g	45,29	10	7751

Kit de reparación para 7755-3/8



**7755-SO/1**

	€		
6 7755-3/8	29,19	1	7755-SO/1



Kit de reparación para carraca cabeza delgada 3/8" 7750SL



**7750SL-SPARE**

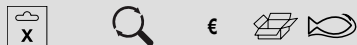

12 7750SL 19,14 1 7750SL-SPARE

Kit de reparación para carraca 3/8 7750



**7750-SPARE**



11 7750 21,04 1 7750-SPARE

Kit de reparación para llave de carraca 3/8" 7710



**7710-SO/1**

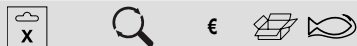

8 7710 28,12 1 7710-SO/1\*

Kit de reparación para carraca 3/8 7750RN



**7750RN-SPARE**



6 7750RN 18,15 1 7750RN-SPARE

1/2"

Vaso de 1/2" hexagonal, mm



**7800SM**



8 mm	6,59	10	7800SM-8
9 mm	6,72	10	7800SM-9
10 mm	6,72	10	7800SM-10
11 mm	6,72	10	7800SM-11
12 mm	7,11	10	7800SM-12
13 mm	7,42	10	7800SM-13
14 mm	7,81	10	7800SM-14
15 mm	8,09	10	7800SM-15
16 mm	8,24	10	7800SM-16
17 mm	8,57	10	7800SM-17
18 mm	8,57	10	7800SM-18
19 mm	8,90	10	7800SM-19
20 mm	9,34	10	7800SM-20
21 mm	9,39	10	7800SM-21
22 mm	9,73	10	7800SM-22
23 mm	10,23	10	7800SM-23
24 mm	10,97	10	7800SM-24
25 mm	11,14	10	7800SM-25
26 mm	11,37	10	7800SM-26
27 mm	11,68	10	7800SM-27
28 mm	12,54	10	7800SM-28
29 mm	13,02	10	7800SM-29
30 mm	13,02	10	7800SM-30
32 mm	13,28	10	7800SM-32
33 mm	11,92	10	7800SM-33
34 mm	17,77	10	7800SM-34
36 mm	25,17	10	7800SM-36

8 mm	7,81	1	SB7800SM-8
9 mm	7,95	1	SB7800SM-9
10 mm	7,95	1	SB7800SM-10
11 mm	7,95	1	SB7800SM-11
12 mm	8,30	1	SB7800SM-12
13 mm	8,61	1	SB7800SM-13
14 mm	8,99	1	SB7800SM-14
15 mm	9,28	1	SB7800SM-15
16 mm	9,46	1	SB7800SM-16
17 mm	9,79	1	SB7800SM-17
18 mm	9,79	1	SB7800SM-18
19 mm	10,11	1	SB7800SM-19
21 mm	10,06	1	SB7800SM-20
21 mm	10,60	1	SB7800SM-21
22 mm	10,92	1	SB7800SM-22
23 mm	11,43	1	SB7800SM-23
24 mm	12,16	1	SB7800SM-24
25 mm	12,34	1	SB7800SM-25
26 mm	12,57	1	SB7800SM-26
27 mm	12,91	1	SB7800SM-27
28 mm	13,75	1	SB7800SM-28
29 mm	13,75	1	SB7800SM-29
30 mm	14,22	1	SB7800SM-30
32 mm	14,50	1	SB7800SM-32
33 mm	14,00	1	SB7800SM-33
34 mm	18,47	1	SB7800SM-34
36 mm	25,87	1	SB7800SM-36

SB: Embalaje en blíster con información del producto

Vasos de 1/2" serie larga hex, mm



**7805SM**



10 mm	17,99	10	7805SM-10
11 mm	17,99	10	7805SM-11
12 mm	17,99	10	7805SM-12
13 mm	17,99	10	7805SM-13
14 mm	18,75	10	7805SM-14
15 mm	19,73	10	7805SM-15
16 mm	20,25	10	7805SM-16
17 mm	20,25	10	7805SM-17
18 mm	20,25	10	7805SM-18
19 mm	20,25	10	7805SM-19
20 mm	20,71	10	7805SM-20
21 mm	22,57	10	7805SM-21
22 mm	22,74	10	7805SM-22
23 mm	23,46	10	7805SM-23
24 mm	23,46	10	7805SM-24
25 mm	22,66	10	7805SM-25
26 mm	23,46	10	7805SM-26
27 mm	26,00	10	7805SM-27
28 mm	24,25	10	7805SM-28
29 mm	25,87	10	7805SM-29
30 mm	27,80	10	7805SM-30
32 mm	30,08	10	7805SM-32
34 mm	30,08	10	7805SM-34

10 mm	18,68	1	SB7805SM-10
11 mm	12,89	1	SB7805SM-11
12 mm	18,68	1	SB7805SM-12
13 mm	18,68	1	SB7805SM-13
14 mm	19,45	1	SB7805SM-14
15 mm	20,45	1	SB7805SM-15
16 mm	20,95	1	SB7805SM-16
17 mm	20,95	1	SB7805SM-17
18 mm	20,95	1	SB7805SM-18
19 mm	20,95	1	SB7805SM-19
20 mm	21,70	1	SB7805SM-20
21 mm	23,28	1	SB7805SM-21
22 mm	23,46	1	SB7805SM-22
23 mm	24,17	1	SB7805SM-23
24 mm	24,17	1	SB7805SM-24
25 mm	24,17	1	SB7805SM-25
26 mm	24,17	1	SB7805SM-26
27 mm	26,67	1	SB7805SM-27
28 mm	24,90	1	SB7805SM-28
29 mm	26,59	1	SB7805SM-29
30 mm	28,49	1	SB7805SM-30
32 mm	30,79	1	SB7805SM-32
34 mm	33,65	1	SB7805SM-34

SB: Embalaje en blíster con información del producto

\* Hasta agotar existencias



Vaso 1/2" cuadrado, serie larga



**7805SZ**

Ø	€		
1.3/16 in	23,68	1	7805SZ-1.3/16
1.1/4 in	25,12	1	7805SZ-1.1/4
1.5/16 in	27,12	1	7805SZ-1.5/16
1.3/8 in	28,88	1	7805SZ-1.3/8
1.7/16 in	46,12	1	7805SZ-1.7/16
1.1/2 in	46,12	1	7805SZ-1.1/2

Ø	€		
15 mm	9,28	1	SB7800DM-15
16 mm	9,46	1	SB7800DM-16
17 mm	9,79	1	SB7800DM-17
18 mm	9,79	1	SB7800DM-18
19 mm	10,11	1	SB7800DM-19
21 mm	10,35	1	SB7800DM-20
21 mm	10,60	1	SB7800DM-21
22 mm	10,92	1	SB7800DM-22
23 mm	11,43	1	SB7800DM-23
24 mm	12,16	1	SB7800DM-24
25 mm	12,34	1	SB7800DM-25
26 mm	12,57	1	SB7800DM-26
27 mm	12,91	1	SB7800DM-27
28 mm	13,75	1	SB7800DM-28
29 mm	14,07	1	SB7800DM-29
30 mm	14,22	1	SB7800DM-30
31 mm	14,60	1	SB7800DM-31
32 mm	14,75	1	SB7800DM-32
33 mm	12,59	1	SB7800DM-33
34 mm	17,67	1	SB7800DM-34
36 mm	26,90	1	SB7800DM-36

SB: Embalaje en blíster con información del producto

Vaso de 1/2" bihex, mm



**7800DM**

Ø	€		
8 mm	6,59	10	7800DM-8
9 mm	6,59	10	7800DM-9
10 mm	6,59	10	7800DM-10
11 mm	6,72	10	7800DM-11
12 mm	7,11	10	7800DM-12
13 mm	7,42	10	7800DM-13
14 mm	7,81	10	7800DM-14
15 mm	8,09	10	7800DM-15
16 mm	8,24	10	7800DM-16
17 mm	8,57	10	7800DM-17
18 mm	8,57	10	7800DM-18
19 mm	8,90	10	7800DM-19
20 mm	9,15	10	7800DM-20
21 mm	9,39	10	7800DM-21
22 mm	9,73	10	7800DM-22
23 mm	10,23	10	7800DM-23
24 mm	10,97	10	7800DM-24
25 mm	11,14	10	7800DM-25
26 mm	11,37	10	7800DM-26
27 mm	11,68	10	7800DM-27
28 mm	12,54	10	7800DM-28
29 mm	12,86	10	7800DM-29
30 mm	13,02	10	7800DM-30
31 mm	13,24	10	7800DM-31
32 mm	13,53	10	7800DM-32
33 mm	11,92	10	7800DM-33
34 mm	16,98	10	7800DM-34
36 mm	25,64	10	7800DM-36
8 mm	7,81	1	SB7800DM-8
9 mm	7,81	1	SB7800DM-9
10 mm	7,81	1	SB7800DM-10
11 mm	7,92	1	SB7800DM-11
12 mm	8,30	1	SB7800DM-12
13 mm	8,61	1	SB7800DM-13
14 mm	8,99	1	SB7800DM-14

Vasos de 1/2" bihexagonal, pulgadas



**7800DZ**

Ø	€		
5/16 in	8,33	10	7800DZ-5/16
11/32 in	8,33	10	7800DZ-11/32
3/8 in	6,75	10	7800DZ-3/8
13/32 in	8,33	10	7800DZ-13/32
7/16 in	6,93	10	7800DZ-7/16
1/2 in	7,61	10	7800DZ-1/2
9/16 in	8,11	10	7800DZ-9/16
19/32 in	8,33	10	7800DZ-19/32
5/8 in	8,57	10	7800DZ-5/8
11/16 in	8,81	10	7800DZ-11/16
3/4 in	9,24	10	7800DZ-3/4
25/32 in	9,39	10	7800DZ-25/32
13/16 in	9,73	10	7800DZ-13/16
7/8 in	10,06	10	7800DZ-7/8
15/16 in	11,29	10	7800DZ-15/16
1 in	11,37	10	7800DZ-1
1 1/16 in	12,03	10	7800DZ-1.1/16
1 1/8 in	12,79	10	7800DZ-1.1/8
1 3/16 in	13,52	10	7800DZ-1.3/16
1 1/4 in	13,69	10	7800DZ-1.1/4
1.5/16 in	12,00	10	7800DZ-1.5/16
1.3/8 in	12,00	10	7800DZ-1.3/8
1.7/16 in	12,48	1	7800DZ-1.7/16
1.1/2 in	11,56	10	7800DZ-1.1/2
5/16 in	8,85	1	SB7800DZ-5/16
11/32 in	8,85	1	SB7800DZ-11/32
3/8 in	7,47	1	SB7800DZ-3/8
13/32 in	8,85	1	SB7800DZ-13/32
7/16 in	7,62	1	SB7800DZ-7/16
1/2 in	8,31	1	SB7800DZ-1/2
9/16 in	8,81	1	SB7800DZ-9/16
19/32 in	9,04	1	SB7800DZ-19/32
5/8 in	9,28	1	SB7800DZ-5/8
11/16 in	9,53	1	SB7800DZ-11/16
3/4 in	9,94	1	SB7800DZ-3/4

Ø	€		
25/32 in	10,10	1	SB7800DZ-25/32
13/16 in	10,43	1	SB7800DZ-13/16
7/8 in	10,75	1	SB7800DZ-7/8
15/16 in	12,00	1	SB7800DZ-15/16
1 in	12,07	1	SB7800DZ-1
1.1/16 in	12,74	1	SB7800DZ-1.1/16
1.1/8 in	13,47	1	SB7800DZ-1.1/8
1.3/16 in	14,23	1	SB7800DZ-1.3/16
1.1/4 in	14,38	1	SB7800DZ-1.1/4
1.5/16 in	14,15	1	SB7800DZ-1.5/16
1.3/8 in	12,51	1	SB7800DZ-1.3/8
1.7/16 in	13,00	1	SB7800DZ-1.7/16
1.1/2 in	12,07	1	SB7800DZ-1.1/2

SB: Embalaje en blíster con información del producto

Vasos largos 1/2" hexagonales pulgadas



**7800SZ**

Ø	€		
3/8 in	4,54	10	7800SZ-3/8
7/16 in	4,72	10	7800SZ-7/16
1/2 in	7,61	10	7800SZ-1/2
9/16 in	4,78	10	7800SZ-9/16
5/8 in	8,56	10	7800SZ-5/8
11/16 in	5,57	10	7800SZ-11/16
3/4 in	5,78	10	7800SZ-3/4
13/16 in	5,88	10	7800SZ-13/16
7/8 in	6,23	10	7800SZ-7/8
15/16 in	6,90	10	7800SZ-15/16
1/2 in	7,21	10	7800SZ-1
1.1/16 in	7,02	10	7800SZ-1.1/16
1 1/8 in	8,19	10	7800SZ-1.1/8
1 3/16 in	8,02	10	7800SZ-1.3/16
1 1/4 in	8,02	10	7800SZ-1.1/4

SB: presentación clip colgable

Vaso de 1/2" bihexagonal, mm



**7805DM**

Ø	€		
10 mm	17,65	10	7805DM-10
12 mm	17,65	10	7805DM-12
13 mm	17,65	10	7805DM-13
14 mm	18,46	10	7805DM-14
15 mm	19,39	10	7805DM-15

Ø	€		
16 mm	19,95	10	7805DM-16
17 mm	19,95	10	7805DM-17
18 mm	19,95	10	7805DM-18
19 mm	19,95	10	7805DM-19
21 mm	22,17	10	7805DM-21
22 mm	22,38	10	7805DM-22
23 mm	22,45	10	7805DM-23
24 mm	23,05	10	7805DM-24
26 mm	23,05	10	7805DM-26
27 mm	25,54	10	7805DM-27
30 mm	27,32	10	7805DM-30
32 mm	28,00	10	7805DM-32
34 mm	28,00	10	7805DM-34
<hr/>			
10 mm	18,38	1	SB7805DM-10
12 mm	18,38	1	SB7805DM-12
13 mm	18,38	1	SB7805DM-13
14 mm	19,15	1	SB7805DM-14
15 mm	20,10	1	SB7805DM-15
16 mm	20,66	1	SB7805DM-16
17 mm	20,66	1	SB7805DM-17
18 mm	20,66	1	SB7805DM-18
19 mm	20,66	1	SB7805DM-19
21 mm	22,87	1	SB7805DM-21
22 mm	23,06	1	SB7805DM-22
23 mm	23,11	1	SB7805DM-23
24 mm	23,75	1	SB7805DM-24
26 mm	23,75	1	SB7805DM-26
27 mm	26,25	1	SB7805DM-27
30 mm	28,04	1	SB7805DM-30
32 mm	28,66	1	SB7805DM-32
34 mm	22,33	1	SB7805DM-34

SB: Embalaje en blister con información del producto

### Vaso 1/2", serie larga



### 7805DZ

Ø	€		
5/8 in	17,27	10	7805DZ-5/8*
11/16 in	17,27	10	7805DZ-11/16*
3/4 in	17,27	10	7805DZ-3/4*
13/16 in	19,21	10	7805DZ-13/16*
7/8 in	19,38	10	7805DZ-7/8*
15/16 in	19,99	10	7805DZ-15/16*
1 in	20,95	10	7805DZ-1*
1.1/16 in	22,15	10	7805DZ-1.1/16*
1.1/8 in	24,83	10	7805DZ-1.1/8*
1.13/16 in	23,68	10	7805DZ-1.3/16*
1.1/4 in	25,12	10	7805DZ-1.1/4*
1.5/16 in	27,12	10	7805DZ-1.5/16*
1.3/8 in	28,88	10	7805DZ-1.3/8*
1.7/16 in	46,12	10	7805DZ-1.7/16*
1.1/2 in	46,12	10	7805DZ-1.1/2*

### Vasos de 1/2" con perfil estriado en mm



### 7800SPL

Ø	€		
10 mm	6,72	10	7800SPL-10
11 mm	6,72	10	7800SPL-11
12 mm	7,11	10	7800SPL-12
13 mm	7,42	10	7800SPL-13
14 mm	7,81	10	7800SPL-14
15 mm	8,09	10	7800SPL-15
16 mm	8,24	10	7800SPL-16
17 mm	8,57	10	7800SPL-17
18 mm	8,57	10	7800SPL-18
19 mm	8,90	10	7800SPL-19
20 mm	9,34	10	7800SPL-20
21 mm	9,39	10	7800SPL-21
22 mm	9,73	10	7800SPL-22
23 mm	10,23	10	7800SPL-23
24 mm	10,97	10	7800SPL-24
27 mm	11,68	10	7800SPL-27
30 mm	7,78	10	7800SPL-30
32 mm	13,28	10	7800SPL-32

### Vaso TORX® hembra, cuadrado 1/2"



### 7800TORX-E

Ø	€		
E8	9,53	1	7800TORX-E8
E10	10,71	1	7800TORX-E10
E11	10,71	1	7800TORX-E11
E12	10,71	1	7800TORX-E12
E14	10,71	1	7800TORX-E14
E16	10,88	1	7800TORX-E16
E18	10,88	1	7800TORX-E18
E20	11,46	1	7800TORX-E20
E24	12,60	1	7800TORX-E24
<hr/>			
E8	10,23	1	SB7800TORX-E8
E10	11,43	1	SB7800TORX-E10
E11	11,43	1	SB7800TORX-E11
E12	11,43	1	SB7800TORX-E12
E14	11,43	1	SB7800TORX-E14
E16	11,58	1	SB7800TORX-E16
E18	11,58	1	SB7800TORX-E18
E20	12,16	1	SB7800TORX-E20
E24	13,31	1	SB7800TORX-E24

SB: Embalaje en blister con información del producto

### Berbiquí 1/2", con mango de acero giratorio



### 8152-1/2

L	€		
425 mm	48,87	1	8152-1/2

### Mango articulado de 1/2"



### 8157

L	€		
257 mm	97,43	1	8157-10
390 mm	56,66	1	8157-15
600 mm	89,10	1	8157-24
900 mm	136,66	10	8157-36
<hr/>			
257 mm	98,60	1	SB8157-10
390 mm	57,84	1	SB8157-15
600 mm	99,68	1	SB8157-24
900 mm	137,83	1	SB8157-36

SB: Clip para colgar

### Mango articulado de 1/2"



### 8158

L	€		
270 mm	31,30	1	8158-10
390 mm	33,42	1	8158-15
<hr/>			
270 mm	35,73	1	SB8158-10
390 mm	45,55	1	SB8158-15

SB=embalaje en blister

\* Hasta agotar existencias



Mango acodado 1/2"



**8178**

L	€	Icon	Icon
180 mm	16,13	10	8178

Alargadera de 1/2"



**8160**

L	€	Icon	Icon
75 mm	12,88	10	8160-3
125 mm	15,18	8	8160-5
250 mm	19,13	10	8160-10
75 mm	16,91	1	SB8160-3
125 mm	11,40	1	SB8160-5
250 mm	20,45	1	SB8160-10

SB: Clip para colgar

Articulación universal de 1/2"



**8166**

L	€	Icon	Icon
72 mm	33,95	10	8166
72 mm	36,82	1	SB8166

SB: Clip para colgar

Mango corredizo en T, 1/2"



**8154**

L	€	Icon	Icon
280 mm	19,59	10	8154-11
280 mm	24,73	1	SB8154-11

SB: Clip para colgar

Alargadera angular 1/2"



**8159-W - 8162-W**

L	€	Icon	Icon
75 mm	16,64	10	8160W-3
125 mm	17,47	8	8160W-5
250 mm	21,93	10	8160W-10

Articulación universal de 1/2",  
funcionamiento fluido



**8168**

L	€	Icon	Icon
62 mm	39,47	40	8168

Adaptador cabeza corrediza 3/8" a 1/2"



**7772H**

Icon	Icon	€	Icon	Icon
3/8"	1/2"	3,20	10	7772H

Alargadera con bloqueo 1/2"



**8160-B**

L	€	Icon	Icon
125 mm	28,51	1	8160-B

Reductor de entrada 1/2" a salida 3/8"



**8171**

Icon	Icon	€	Icon	Icon
1/2"	3/8"	17,48	20	8171
1/2"	3/8"	20,45	1	SB8171

Este producto no está garantizado contra la rotura del cuadrado macho.



Llave combinada escalonada



**8195-key**

	€		
140 g	22,03	50	8195-KEY

Para usar con 8195-R

Adaptador de 1/2" para puntas 5/16"



**8174A**

	€		
5/16 in	10,03	10	8174A

Regletas y clips 1/2"



**C1/2**

	€		
19 mm	0,39	25	CLIPS-1/2

Aumentador de entrada 1/2" a salida 3/4"



**8172**

		€		
1/2"	3/4"	20,79	10	8172
1/2"	3/4"	24,03	1	SB8172

SB=embalaje en blister

Kit de repuestos para mango mango articulado 1/2" 8169-1/2



**SP120**

	€		
75 g	27,60	1	SP120

Vaso con punta recta cuadrado 1/2"



**7809F**

		€		
0.8 mm	8 mm	14,74	5	7809F-8
1 mm	10 mm	15,03	5	7809F-10

Amplificador plano de 1/2" a 3/4"



**8967**

		€		
1/2	3/4	33,63	1	8967

Kit de repuestos para mango mango articulado 1/2" 8170-1/2



**SP120XL**

	€		
55 g	13,14	1	SP120XL

Vaso con punta Phillips cuadrado 1/2"



**7809PH**

	€		
2	12,83	1	7809PH-2
3	13,24	1	7809PH-3
4	13,24	1	7809PH-4





Vaso con punta Pozidriv cuadrado 1/2"



### 7809PZ

	€		
3	13,30	1	7809PZ-3*

Vaso con punta TORX® cuadrado 1/2"



### 7809TORX

	€		
T20	15,17	1	7809TORX-T20
T25	15,17	1	7809TORX-T25
T27	15,17	1	7809TORX-T27
T30	15,17	1	7809TORX-T30
T40	17,71	1	7809TORX-T40
T45	17,71	1	7809TORX-T45
T50	17,71	1	7809TORX-T50
T55	22,17	1	7809TORX-T55
T60	22,17	1	7809TORX-T60
T70	22,18	10	7809TORX-T70
T20	16,38	1	SB7809TORX-T20
T25	16,38	1	SB7809TORX-T25
T27	16,38	1	SB7809TORX-T27
T30	16,38	1	SB7809TORX-T30
T40	18,94	1	SB7809TORX-T40
T45	18,94	1	SB7809TORX-T45
T50	18,94	1	SB7809TORX-T50
T55	23,42	1	SB7809TORX-T55
T60	23,42	1	SB7809TORX-T60

SB: Embalaje en blister con información del producto

Vasos largos con punta TORX® cuadrado 1/2"



### 7809TORX L

		€		
T20	80 mm	20,69	1	7809TORX-T20-120
T25	80 mm	20,69	1	7809TORX-T25-120
T27	80 mm	20,69	1	7809TORX-T27-120
T30	80 mm	20,69	1	7809TORX-T30-120
T40	82 mm	22,63	1	7809TORX-T40-120
T45	80 mm	22,63	1	7809TORX-T45-120
T50	62 mm	22,63	1	7809TORX-T50-100
T50	80 mm	21,33	1	7809TORX-T50-120
T55	80 mm	26,20	1	7809TORX-T55-120
T60	80 mm	26,20	1	7809TORX-T60-120
T70	102 mm	32,01	5	7809TORX-T70-140
T70	80 mm	25,41	1	7809TORX-T70-120

Juego de 9 vasos con punta TORX® 1/2" en rail



### 7809TO

		€		
9	770 g	156,22	1	7809TO

7809TORX-T27, 7809TORX-T20, 7809TORX-T25, 7809TORX-T30, 7809TORX-T50, 7809TORX-T40, 7809TORX-T45, 7809TORX-T60, 7809TORX-T55

Juego de vasos con punta y cuadradillo de 1/2" para tornillo de cabeza TORX® (9 piezas)



### 7800TORX/9

	€		
46 x 130 x 195 mm	95,80	1	7800TORX/9

7800TORX-E8, 7800TORX-E10, 7800TORX-E11, 7800TORX-E12, 7800TORX-E14, 7800TORX-E16, 7800TORX-E18, 7800TORX-E20, 7800TORX-E24

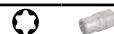

Vaso con punta hexagonal cuadrado 1/2", mm



### 7809M

	€		
4 mm	13,37	10	7809M-4
5 mm	13,37	1	7809M-5
6 mm	13,37	1	7809M-6
7 mm	13,37	1	7809M-7
8 mm	14,50	1	7809M-8
9 mm	14,50	1	7809M-9
10 mm	14,50	1	7809M-10
12 mm	14,82	1	7809M-12
14 mm	14,85	1	7809M-14
17 mm	15,58	1	7809M-17
19 mm	16,02	1	7809M-19
4 mm	14,60	1	SB7809M-4
5 mm	14,60	1	SB7809M-5
6 mm	14,60	1	SB7809M-6
7 mm	14,60	1	SB7809M-7
8 mm	15,71	1	SB7809M-8
9 mm	15,71	1	SB7809M-9
10 mm	15,02	1	SB7809M-10
12 mm	16,05	1	SB7809M-12
14 mm	16,45	1	SB7809M-14
17 mm	16,97	1	SB7809M-17
19 mm	17,23	1	SB7809M-19

SB: Embalaje en blister con información del producto

Vasos largos con punta hexagonal, cuadrado 1/2"



### 7809M-L

		€		
4 mm	80 mm	13,83	1	7809M-4-120
5 mm	80 mm	13,83	1	7809M-5-120
5 mm	143 mm	17,70	1	7809M-5-180
6 mm	80 mm	13,83	1	7809M-6-120
7 mm	63 mm	13,28	1	7809M-7-100
7 mm	80 mm	17,58	1	7809M-7-120

Ø	L	€	📦	🐟
8 mm	83 mm	13,83	1	7809M-8-120
10 mm	80 mm	15,54	1	7809M-10-120
12 mm	80 mm	15,93	1	7809M-12-120
14 mm	80 mm	16,27	10	7809M-14-120
17 mm	80 mm	16,61	10	7809M-17-120
19 mm	80 mm	17,02	8	7809M-19-120

Destornilladores de vaso profundo con cuadrado de 1/2" para tornillo métrico de cabeza hexagonal



### SB7809M-XX-120

Ø	L	€	📦	🐟
4 mm	80 mm	20,13	1	SB7809M-4-120
5 mm	63 mm	19,68	1	SB7809M-5-100*
5 mm	80 mm	20,25	1	SB7809M-5-120
5 mm	140 mm	18,10	1	SB7809M-5-180
6 mm	80 mm	20,50	1	SB7809M-6-120
7	80 mm	20,75	1	SB7809M-7-120
8 mm	81 mm	21,44	1	SB7809M-8-120
10 mm	80 mm	20,27	1	SB7809M-10-120
12 mm	80 mm	24,83	1	SB7809M-12-120
14 mm	80 mm	25,25	1	SB7809M-14-120
17 mm	80 mm	25,68	1	SB7809M-17-120
19 mm	80 mm	26,19	1	SB7809M-19-120

SB=embalaje en blister

Juego de 8 vasos con punta hexagonal 1/2" en rail, mm



### 7808HM

📦	g	€	📦	🐟
8	810 g	113,67	1	7808HM

7809M-4, 7809M-6, 7809M-8, 7809M-7, 7809M-5, 7809M-10, 7809M-12, 7809M-14

Vaso con punta hexagonal cuadrado 1/2", pulgadas



### 7809Z

Ø	€	📦	🐟
1/4 in	13,13	1	7809Z-3/16
5/16 in	13,13	1	7809Z-1/4
3/8 in	13,13	1	7809Z-5/16
7/16 in	13,50	1	7809Z-3/8
1/2 in	14,26	1	7809Z-7/16
17/32 in	14,74	1	7809Z-1/2
9/16 in	14,63	1	7809Z-17/32
19/32 in	15,00	1	7809Z-9/16
5/8 in	15,00	1	7809Z-19/32

Vaso con punta XZN cuadrado 1/2"



### 7809XZN

Ø	€	📦	🐟
6	18,62	1	7809XZN-6
8	18,75	1	7809XZN-8
8	20,51	1	7809XZN-8-100
10	19,67	1	7809XZN-10
10	24,32	1	7809XZN-10-100
12	24,32	1	7809XZN-12
12	26,56	1	7809XZN-12-100
14	25,99	1	7809XZN-14
14	30,40	1	7809XZN-14-100
16	28,48	1	7809XZN-16
18	30,34	1	7809XZN-18

Llave de carraca 1/2" cabeza delgada 72 dientes



### 8150SL

L	€	📦	🐟	
264 mm	72	68,04	1	8150SL

Llave de carraca reversible 1/2"



### 8150-1/2

L	€	📦	🐟	
269 mm	80	66,85	1	8150-1/2
269 mm	80	67,63	1	SB8150-1/2

SB: Clip para colgar

Llave de carraca reversible, 1/2"



### 8150RN-1/2

L	€	📦	🐟	
267 mm	72	64,56	1	8150RN-1/2
267 mm	72	65,33	1	SB8150RN-1/2

SB: Clip para colgar

Llave de carraca reversible de 1/2"



### 8150QR

L	€	📦	🐟	
250 m	60	38,51	3	8150QR
250 m	60	28,12	1	SB8150QR

SB=embalaje en blister

\* Hasta agotar existencias



Juego de 4 accesorios de 1/2"



**SB81-SET1**

	€		
35 x 170 x 450 mm	36,67	8	SB81-SET1

SB=embalaje en blister

8150QR	
8158-15	
8160-10	
8172	

Carraca de cabeza tipo pera reversible 1/2" con 60 dientes, mango metálico



**8150MH**

		€		
200 mm	60	40,69	5	8150MH

Carraca 1/2" con cabeza giratoria



**8120-1/2**

		€		
266 mm	72	62,09	12	8120-1/2

Carraca reversible 1/2", cuadrado pasante



**8195-R**

		€		
260 mm	60	54,52	1	8195-R

Set carraca de válvula de radiador



**8195-SET**

	€		
350 x 20 x 80 mm	66,40	5	8195-SET

8195-R	
8195-SQ	
8195-KEY	

Llave de carraca articulada de 1/2" reversible



**8110H-1/2**

		€		
440 mm	32	102,97	1	8110H-1/2

Conductor para la llave de carraca 8193-1/2



**8194-1/2**

	€		
32 mm	6,42	1	8194-1/2*

Conductor para carraca 8195-R



**8195-SQ**

		€		
37.5 mm	40 g	5,85	25	8195-SQ

Adaptador para llave de carraca de 1/2"



**8151-1/2**

	€		
71 mm	87,93	1	8151-1/2

Kit de reparación para llave de carraca de 1/2" 8155-1/2



**8155-SO/1**

		€		
6	8155-1/2	50,51	1	8155-SO/1

Kit de reparación para carraca 1/2 8150RN-1/2



**8150RN-1/2-SPARE**

		€		
6	8150RN-1/2	19,51	1	8150RN-1/2-SPARE

Vasos estándar, cuadrado 3/4"



**8900SZ**

	€		
3/4 in	16,35	1	8900SZ-3/4*
13/16 in	22,56	1	8900SZ-13/16*
1 in	24,73	1	8900SZ-1*
1.7/16 in	31,05	1	8900SZ-1.7/16*
1.9/16 in	32,35	1	8900SZ-1.9/16*
1.7/8 in	43,01	1	8900SZ-1.7/8*
2 in	46,87	1	8900SZ-2*

Kit de reparación para carraca cabeza delgada 1/2" 8150SL



**8150SL-SPARE**

		€		
12	8150SL	21,17	1	8150SL-SPARE

**3/4"**

Vasos de 3/4" hexagonales, mm



**8900SM**

	€		
19 mm	18,57	1	8900SM-19
22 mm	18,57	1	8900SM-22
23 mm	18,57	1	8900SM-23
24 mm	19,93	5	8900SM-24
26 mm	20,20	5	8900SM-26
27 mm	20,59	5	8900SM-27
28 mm	20,59	1	8900SM-28
29 mm	23,07	1	8900SM-29
30 mm	23,07	5	8900SM-30
32 mm	24,06	5	8900SM-32
33 mm	24,06	1	8900SM-33
34 mm	25,60	1	8900SM-34
35 mm	25,60	1	8900SM-35
36 mm	27,83	5	8900SM-36
38 mm	29,61	1	8900SM-38
41 mm	32,63	5	8900SM-41
42 mm	32,63	1	8900SM-42
46 mm	38,50	1	8900SM-46
50 mm	43,88	1	8900SM-50
55 mm	52,79	1	8900SM-55
60 mm	58,69	1	8900SM-60

Vaso longitud estándar, cuadrado 3/4"



**8900DM**

	€		
19 mm	18,32	1	8900DM-19
21 mm	15,82	5	8900DM-21
22 mm	18,86	1	8900DM-22
23 mm	17,86	1	8900DM-23
24 mm	20,20	1	8900DM-24
25 mm	19,62	1	8900DM-25
26 mm	17,71	1	8900DM-26
27 mm	20,59	1	8900DM-27
28 mm	21,60	1	8900DM-28
29 mm	20,31	1	8900DM-29
30 mm	23,07	5	8900DM-30
32 mm	24,06	1	8900DM-32
33 mm	23,68	1	8900DM-33
34 mm	25,60	1	8900DM-34
35 mm	23,68	1	8900DM-35
36 mm	27,83	1	8900DM-36
37 mm	28,53	1	8900DM-37
38 mm	32,67	1	8900DM-38
40 mm	35,14	1	8900DM-40
41 mm	32,63	5	8900DM-41
42 mm	35,13	1	8900DM-42
46 mm	38,50	1	8900DM-46
47 mm	36,11	1	8900DM-47
50 mm	43,87	5	8900DM-50
52 mm	46,00	1	8900DM-52
40 mm	46,00	3	8900DM-54
55 mm	52,80	1	8900DM-55
56 mm	53,86	1	8900DM-56
60 mm	58,69	5	8900DM-60

Kit de reparación para carraca 1/2 8150-1/2



**8150-1/2-SPARE**

		€		
11	8150-1/2	31,50	1	8150-1/2-SPARE

\* Hasta agotar existencias



Vaso longitud estándar, cuadrado 3/4"



**8900DZ**

	€		
3/4 in	12,90	1	8900DZ-3/4
13/16 in	16,82	1	8900DZ-13/16
7/8 in	20,42	1	8900DZ-7/8
15/16 in	20,17	1	8900DZ-15/16
31/32 in	23,24	1	8900DZ-31/32
1 in	20,33	1	8900DZ-1
1 1/16 in	21,00	1	8900DZ-1.1/16
1 1/8 in	22,02	1	8900DZ-1.1/8
1 3/16 in	24,33	1	8900DZ-1.3/16
1 1/4 in	24,34	1	8900DZ-1.1/4
1 5/16 in	26,40	5	8900DZ-1.5/16
1 3/8 in	26,40	1	8900DZ-1.3/8
1 7/16 in	27,77	1	8900DZ-1.7/16
1 1/2 in	29,84	1	8900DZ-1.1/2
1.9/16 in	34,47	1	8900DZ-1.9/16
1 5/8 in	33,61	1	8900DZ-1.5/8
1.11/16 in	34,88	1	8900DZ-1.11/16
1 3/4 in	39,00	1	8900DZ-1.3/4
1 13/16 in	39,00	1	8900DZ-1.13/16
1 7/8 in	44,41	1	8900DZ-1.7/8
2 in	44,41	1	8900DZ-2
2.1/16 in	44,30	1	8900DZ-2.1/16
2.1/8 in	44,31	1	8900DZ-2.1/8
2.3/16 in	50,42	1	8900DZ-2.3/16
2.1/4 in	46,25	1	8900DZ-2.1/4
2.3/8 in	55,71	1	8900DZ-2.3/8

Mango universal para cabeza de carraca de 3/4" 8950N/A



**8953**

	€		
405 m	36,67	1	8953-16

Compatible con 8958A y 8954A

Extensión telescópica 3/4"



**8953E-32**

	€		
495 to 810 mm	80,31	1	8953E-32

Mango corredizo en T de 3/4"



**8954**

	€		
390 mm	71,30	1	8954-15

Mango universal 8953 y cabeza 8954A

Cabeza corrediza de 3/4"



**8954A**

	€		
62 mm	37,76	1	8954A

Mangos articulados con cabeza flexible de 3/4" de cuadradillo



**8957-19**

	€		
480 mm	97,08	1	8957-19

Cabeza para mango articulado de 3/4"



**8958A**

	€		
125 mm	95,74	1	8958A*

Cabezas flexibles con cuadradillo de 3/4" para barra rompedora 8957



**8957A**

	€		
140 mm	78,80	1	8957A

Mango acodado 3/4"



**8963**

	€		
415 mm	40,75	1	8963

Alargadera de 3/4"



**8960**

	€		
200 mm	40,20	1	8960-8
400 mm	50,08	12	8960-16

Articulación universal de 3/4"



**8966**

	€		
120 mm	97,49	1	8966



Reductor de entrada 3/4" a salida 1/2"



**8971**

		€		
3/4"	1/2"	27,48	1	8971

Este producto no está garantizado contra la rotura del cuadrado macho

Aumentador de entrada 3/4" a salida 1"



**8972**

		€		
3/4"	1"	30,71	1	8972

Llave de carraca de 3/4" reversible



**8950RN**

		€		
525 mm	72	132,93	1	8950RN

Compuesto por 8950N/A + 8953

Carracas 3/4"



**8955N**

		€		
525 mm	24	120,60	1	8955N

Cabeza de carraca de 3/4", reversible



**8950RN/A**

		€		
170 mm	72	116,70	1	8950RN/A

Con el mango 8953 forma la carraca 8950N

Accesorios para carraca de 3/4"



**8955N/A**

		€		
152 mm	24	95,21	1	8955N/A

Mango universal 3/4"



**8955N/B**

		€		
1160 g	390 mm	33,95	5	8955N/B

Cabeza de carraca 3/4" cuadrado macho y hembra



**8951**

	€		
95.5 mm	357,33	1	8951

Compatible con mango corredizo

Kit de reparación para carracas de 3/4" 8950N, 8950N/A



**8950NA-SO/2**

		€		
8	8950N, 8950N/A	102,69	1	8950NA-SO/2*

Repuesto para carracas de 3/4"



**8955N-SPARE**

		€		
11	8955N, 8955N/A	50,77	1	8955N-SPARE

\* Hasta agotar existencias



1"

Vaso Hexagonal 1", mm



**9500SM**

	€		
41 mm	48,08	1	9500SM-41
46 mm	56,07	1	9500SM-46
50 mm	62,03	1	9500SM-50
54 mm	66,11	1	9500SM-54
55 mm	70,61	1	9500SM-55
58 mm	77,17	1	9500SM-58
60 mm	86,24	1	9500SM-60
63 mm	96,67	1	9500SM-63
65 mm	103,08	1	9500SM-65
67 mm	109,79	1	9500SM-67
70 mm	115,81	1	9500SM-70
71 mm	121,89	1	9500SM-71
75 mm	129,63	1	9500SM-75
77 mm	137,87	1	9500SM-77
80 mm	147,62	1	9500SM-80
82 mm	157,39	1	9500SM-82

Vaso estándar, 1"



**9500DZ**

	€		
1.5/8 in	35,45	1	9500DZ-1.5/8
1.13/16 in	41,31	1	9500DZ-1.13/16
1.7/8 in	41,31	1	9500DZ-1.7/8
2 in	54,25	1	9500DZ-2
2.1/8 in	54,25	1	9500DZ-2.1/8
2.3/16 in	54,25	1	9500DZ-2.3/16
2.1/4 in	54,25	1	9500DZ-2.1/4
2.3/8 in	62,43	1	9500DZ-2.3/8
2.1/2 in	62,43	1	9500DZ-2.1/2
2.9/16 in	62,43	1	9500DZ-2.9/16
2.5/8 in	72,33	1	9500DZ-2.5/8
2.3/4 in	70,98	1	9500DZ-2.3/4
2.15/16 in	84,82	1	9500DZ-2.15/16
3 in	97,45	1	9500DZ-3
3.1/8 in	97,45	1	9500DZ-3.1/8

Mango corredizo en T 1"



**9555**

L	€		
508 mm	103,07	1	9555

Cabeza de mango corredizo 9555AB y mango universal 9552AB

Cabeza corrediza, 1"



**9555AB**

L	€		
78x78x78 mm	48,15	1	9555AB

Alargadera 1"



**9560AB/9563AB**

L	€		
200 mm	77,98	1	9560AB
440 mm	99,90	1	9563AB

Reductor de 1" a 3/4"



**9565AB**

	€		
3/4"	52,11	1	9565AB

Este producto no está garantizado contra la rotura del cuadrado macho

Carraca 1"



**9550N**

L		€		
640 mm	72	270,92	1	9550N

Mango universal 1"



**9550N/B**

g	€		
1960 g	55,55	1	9550N/B

## Accesorios para carraca 1"



### 9550N/A

L	€	g	€	Icon	Icon
195 mm	72	222,19	1	9550N/A	

Icon	g	€	Icon	Icon
110 x 320 x 375 mm	1620 g	52,10	1	S410-CASE*
100 x 215 x 375 mm	1120 g	46,17	1	S460-CASE
100 x 215 x 375 mm	1120 g	45,84	1	S560-CASE
110 x 375 x 430 mm	2200 g	61,81	1	S108-CASE*
110 x 375 x 430 mm	2200 g	53,01	1	SLX17-CASE
100 x 215 x 375 mm	1120 g	44,74	1	S330L-CASE*

## Repuesto para carracas de 1"



### 9550N-SPARE

Icon	€	g	€	Icon	Icon
2	9550N, 9550N/A	76,17	1	9550N-SPARE	

## Caja vacía de plástico inyectado



### 4750IB

Icon	€	Icon	Icon
35 x 80 x 100 mm	13,34	1	SPAR-CASE-A7
35 x 85 x 160 mm	14,03	1	SPAR-CASE-A6
49 x 152 x 280 mm	19,89	1	SPAR-CASE-A4

## CAJAS VACÍAS PARA JUEGOS DE VASOS

### Cajas vacías para juegos de vasos



### -CASE

Icon	g	€	Icon	Icon
110 x 375 x 430 mm	2200 g	63,96	1	S103-CASE
70 x 160 x 280 mm	520 g	16,43	6	S160-BOX
100 x 215 x 370 mm	1120 g	46,16	1	S240AF-CASE*
70 x 160 x 280 mm	500 g	31,94	1	S330-CASE*

## LLAVES DE CARRACA PARA ESTRUCTURAS

### Llave a carraca de doble boca para estructuras



### SC2RM

Icon	€	Icon	Icon
13-17 mm	38,25	10	SC2RM-13-17
15-17 mm	38,87	10	SC2RM-15-17
19-22 mm	40,10	10	SC2RM-19-22
27-30 mm	72,18	1	SC2RM-27-30

\* Hasta agotar existencias





**BAHCO®**



## Herramientas dinamométricas





## LLAVES DINAMOMÉTRICAS DIGITALES

Llave dinamométrica y de ángulo delgada Bluetooth® con memoria y cabeza rectangular intercambiable



### TAWMB MICRO

mm	Nm	Nm	€		
9x12 mm	1.5-30 N·m	0.01 N·m	1.757,85	1	TAWMB930M
9x12 mm	6.8-135 N·m	0.1 N·m	1.873,32	1	TAWMB9135M

PRECISIÓN: 20% a 100% de escala completa

Llave dinamométrica y de ángulo Bluetooth® con memoria y cabeza rectangular intercambiable



### TAWMB14\_24

mm	Nm	Nm	€		
14x18 mm	17-340 N·m	1 N·m	1.988,81	1	TAWMB14340
24x32 mm	32.5-650 N·m	1 N·m	2.296,75	1	TAWMB24650
24x32 mm	40-800 N·m	1 N·m	2.552,60	1	TAWMB24800

PRECISIÓN: 20% a 100% de escala completa

Llave dinamométrica electrónica de par y grados, con memoria/USB y cabeza de carraca fija



### TAWM MICRO

	Nm	Nm	€		
1/4 in	0.6-12 N·m	0.01 N·m	1.083,78	1	TAWM1412M
1/4 in	1.5-30 N·m	0.01 N·m	1.096,92	1	TAWM1430M
3/8 in	6.8-135 N·m	0.1 N·m	1.302,34	1	TAWM38135M

PRECISIÓN: 20% a 100% de escala completa

Llave dinamométrica electrónica de par y grados, con memoria/USB y cabeza intercambiable rectangular



### TAWM9 MICRO

mm	Nm	Nm	€		
9x12 mm	0.6-12 N·m	0.01 N·m	1.058,20	1	TAWM912M
9x12 mm	1.5-30 N·m	0.01 N·m	1.117,39	1	TAWM930M
9x12 mm	6.8-135 N·m	0.1 N·m	1.276,69	1	TAWM9135M

Precisión: 20% a 100% de escala completa

Llave dinamométrica electrónica de par y grados, con memoria/USB y cabeza de carraca fija



### TAWM

	Nm	Nm	€		
1/4 in	1.5-30 N·m	1 N·m	754,15	1	TAWM1430*
3/8 in	7-135 N·m	1 N·m	1.258,74	1	TAWM38135
1/2 in	17-340 N·m	1 N·m	1.237,73	1	TAWM12340
3/4 in	40-800 N·m	1 N·m	1.780,94	1	TAWM34800

Precisión: 20% a 100% de escala completa

Llave dinamométrica electrónica de par y grados, con memoria/USB y cabeza intercambiable rectangular



### TAWM9\_14\_24

mm	Nm	Nm	€		
9x12 mm	7-135 N·m	1 N·m	1.213,09	1	TAWM9135
14x18 mm	17-340 N·m	1 N·m	1.303,42	1	TAWM14340
24x32 mm	40-800 N·m	1 N·m	1.922,88	1	TAWM24800

Precisión: 20% a 100% de escala completa

Llave dinamométrica electrónica de par y ángulo en aluminio



**TAWM alu**

Nm	mm		€		
1.5-30 N-m	9x12 mm	1/4 in	230,55	1	TAWM930A*

Llave dinamométrica electrónica de par y grados y cabeza de carraca fija



**TAW MICRO**

	Nm	Nm	€		
1/4 in	0.6-12 N-m	0.01 N-m	943,63	1	TAW1412M
1/4 in	1.5-30 N-m	0.01 N-m	943,63	1	TAW1430M
3/8 in	6.8-135 N-m	0.1 N-m	936,66	1	TAW38135M

Precisión: 20% a 100% de escala completa

Llave dinamométrica electrónica de par y grados y cabeza intercambiable rectangular



**TAW9 MICRO**

mm	Nm	Nm	€		
9x12 mm	0.6-12 N-m	0.01 N-m	834,01	1	TAW912M
9x12 mm	1.5-30 N-m	0.01 N-m	855,57	1	TAW930M
9x12 mm	6.8-135 N-m	0.1 N-m	910,99	1	TAW9135M

Precisión: 20% a 100% de escala completa

Llave dinamométrica electrónica de par y grados y cabeza de carraca fija



**TAW**

	Nm	Nm	€		
3/8 in	7-135 N-m	1 N-m	728,89	1	TAW38135
1/2 in	17-340 N-m	1 N-m	797,65	1	TAW12340
3/4 in	40-800 N-m	1 N-m	1.416,52	1	TAW34800

Precisión: 20% a 100% de escala completa

Llave dinamométrica electrónica de par y grados y cabeza intercambiable rectangular



**TAW9 14 24**

	Nm	Nm	€		
9x12 mm	7-135 N-m	1 N-m	967,89	1	TAW9135
14x18 mm	17-340 N-m	1 N-m	1.071,13	1	TAW14340
24x32 mm	40-800 N-m	1 N-m	1.270,30	1	TAW24800

Precisión: 20% a 100% de escala completa

Llave dinamométrica electrónica con cabeza intercambiable con conexión rectangular



**IZO-D**

	Nm	Nm	€		
1/4 in	3-30 N-m	0.1 N-m	768,33	1	IZO-D-30
3/8 in	13.5-135 N-m	1 N-m	768,33	1	IZO-D-135
1/2 in	20-200 N-m	1 N-m	842,36	1	IZO-D-200
1/2 in	34-340 N-m	1 N-m	970,67	1	IZO-D-340

IZOD-30: 1/4"-9x12; D135: 3/8" - 9x12 IZO D-200: 1/2" 14x18; IZOD-340: 1/2" 14x18

\* Hasta agotar existencias



Llave dinamométrica electrónica con cabeza fija de carraca



**IZO-DR**

	Nm	Nm	€		
3/4 in	81-810 N·m	1 N·m	2.306,91	1	IZO-DR-810

Cabeza de carraca 3/4"

**LLAVES DINAMOMÉTRICAS MECÁNICAS**

Llave dinamométrica mecánica de disparo ajustable con visor y cabeza fija de carraca



**74WR-15/74WR-25**

	Nm	Nm	€		
1/4 in	3-15 N·m	0.1 N·m	264,22	1	74WR-15
1/4 in	5-25 N·m	0.2 N·m	264,22	1	74WR-25

Llave dinamométrica mecánica de disparo ajustable con visor y cabeza de carraca fija con cuadradillo pasante



**74WR-50/74WR-400**

	Nm	Nm	€		
3/8"	10-50 N·m	0.5 N·m	246,60	1	74WR-50
3/8"	20-100 N·m	1 N·m	251,38	1	74WR-100B
1/2"	20-100 N·m	1 N·m	251,38	1	74WR-100
1/2"	40-200 N·m	2 N·m	251,38	1	74WR-200
1/2"	60-300 N·m	2 N·m	264,22	1	74WR-300
1/2"	60-340 N·m	5 N·m	289,38	1	74WR-340
3/4"	80-400 N·m	5 N·m	349,78	1	74WR-400

Llave dinamométrica de disparo mecánica ajustable con visor y cabeza intercambiable de conexión rectangular



**74W9/74W14**

mm	Nm	Nm	€		
9x12 mm	3-15 N·m	0.2 N·m	251,64	1	74W9-15
9x12 mm	5-25 N·m	0.2 N·m	250,38	1	74W9-25
9x12 mm	10-50 N·m	0.5 N·m	237,80	1	74W9-50
9x12 mm	20-100 N·m	1 N·m	237,80	1	74W9-100
9x12 mm	40-200 N·m	1 N·m	301,97	1	74W9-200
14x18 mm	40-200 N·m	2 N·m	301,97	1	74W14-200
14x18 mm	60-300 N·m	2 N·m	339,70	1	74W14-300
14x18 mm	80-400 N·m	5 N·m	402,62	1	74W14-400

Llave dinamométrica de disparo mecánica ajustable con visor y cabeza intercambiable de conexión cilíndrica



**74WS-15/74WS-300**

mm	Nm	Nm	€		
16 mm	3-15 N·m	0.2 N·m	251,64	1	74WS-15
16 mm	5-25 N·m	0.2 N·m	250,38	1	74WS-25
16 mm	10-50 N·m	0.5 N·m	237,80	1	74WS-50
16 mm	20-100 N·m	1 N·m	237,80	1	74WS-100
16 mm	40-200 N·m	2 N·m	301,97	1	74WS-200
16 mm	60-300 N·m	2 N·m	339,70	1	74WS-300

Llave dinamométrica mecánica de disparo ajustable con escala marcada y cabeza fija de carraca

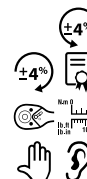

**7455**

	Nm	Nm	€		
1/4 in	1-5 N·m	0.05 N·m	259,44	1	7455-5
1/4 in	3-15 N·m	0.1 N·m	259,44	1	7455-15
1/4 in	4-20 N·m	0.1 N·m	259,44	1	7455-20
1/4 in	5-25 N·m	0.1 N·m	259,44	1	7455-25
3/8 in	12-60 N·m	0.5 N·m	259,45	1	7455-60

			€		
3/8 in	20-100 N·m	0.5 N·m	<b>259,45</b>	1	7455-100
1/2 in	20-100 N·m	0.5 N·m	<b>245,19</b>	1	7455-100A
1/2 in	40-200 N·m	2 N·m	<b>285,38</b>	1	7455-200
1/2 in	60-300 N·m	2 N·m	<b>320,33</b>	1	7455-300
1/2 in	68-340 N·m	2 N·m	<b>320,33</b>	1	7455-340
3/4 in	100-500 N·m	5 N·m	<b>648,60</b>	1	7455-500
3/4 in	160-800 N·m	5 N·m	<b>843,20</b>	1	7455-800
1 in	200-1000 N·m	10 N·m	<b>1.122,77</b>	1	7455-1000

1/4" (7455-5); 3/8" (15-100); 1/2" (200-340) 3/4" (500-800); 1" (1500-2500)

Llave dinamométrica mecánica de disparo ajustable con escala marcada, cabeza fija de carraca y mango de dos secciones



**7455-1500**

			€		
1 in	300-1500 N·m	10 N·m	<b>2.049,57</b>	1	7455-1500

Llave dinamométrica mecánica de disparo ajustable con escala marcada y cabeza de cuadradillo fijo

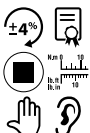

**7455-2500**

			€		
1 in	500-2500 N·m	10 N·m	<b>5.811,44</b>	1	7455-2500

Cuadrado 1"

Llave dinamométrica mecánica de disparo ajustable con escala marcada y cabeza intercambiable



**7465**

			€		
9x12 mm	1-5 N·m	0.05 N·m	<b>227,13</b>	1	7465-5
9x12 mm	3-15 N·m	0.1 N·m	<b>232,30</b>	1	7465-15
9x12 mm	6-30 N·m	0.1 N·m	<b>238,75</b>	1	7465-30
9x12 mm	12-60 N·m	0.5 N·m	<b>245,19</b>	1	7465-60

			€		
9x12 mm	20-100 N·m	0.5 N·m	<b>245,19</b>	1	7465-100
14x18 mm	40-200 N·m	2 N·m	<b>277,46</b>	1	7465-200
14x18 mm	68-340 N·m	2 N·m	<b>303,27</b>	1	7465-340
24x32 mm	160-800 N·m	5 N·m	<b>774,31</b>	1	7465-800

Llave dinamométrica mecánica de disparo ajustable con escala marcada, cabeza intercambiable y mango de dos secciones

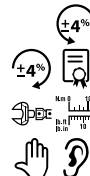

**7465-1500**

			€		
27x36 mm	300-1500 N·m	10 N·m	<b>1.793,83</b>	1	7465-1500

Llave dinamométrica mecánica de disparo ajustable con escala marcada y cabeza de carraca flexible



**7456**

			€		
3/8 in	10-80 lbf·ft	0.5 lbf·ft	<b>324,32</b>	1	7456-80LB

Libras pulgada 120-960

Llave dinamométrica mecánica de disparo de accionamiento libre ajustable con cabeza fija de carraca

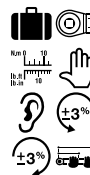

**75R3/75R1**

			€		
3/4" in	130-650 N·m	5 N·m	<b>1.119,79</b>	1	75R3-650
3/4" in	200-800 N·m	10 N·m	<b>1.251,89</b>	1	75R3-800
3/4" in	300-1000 N·m	10 N·m	<b>1.497,23</b>	1	75R3-1000
1" in	500-1500 N·m	10 N·m	<b>1.400,80</b>	1	75R1-1500



Llave dinamométrica mecánica de disparo de accionamiento libre ajustable con cabeza con conexión cilíndrica intercambiable



**75S-650**

			€		
22 mm	130-650 N·m	5 N·m	1.107,21	1	75S-650

Llave dinamométrica mecánica ajustable con cabeza de carraca fija y doble barra de ajuste



**76R1-2000**

			€		
1 in	900-2000 N·m	50 N·m	2.111,50	1	76R1-2000

Llave dinamométrica mecánica articulada ajustable de disparo con visor de escala y cabeza fija de carraca

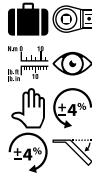

**76R3**

			€		
3/4-1 in	120-600 N·m	10 N·m	692,01	1	76R3-600
3/4-1 in	200-800 N·m	10 N·m	717,17	1	76R3-800
3/4-1 in	300-1000 N·m	20 N·m	748,61	1	76R3-1000

Llave dinamométrica mecánica de flexión de disparo con visor y cabeza intercambiable con conexión cilíndrica



**76S-600**

			€		
22 mm	120-600 N·m	10 N·m	704,58	1	76S-600

Llave dinamométrica mecánica con escala, cabeza cuadrada fija y mango metálico



**7454 M**

			€		
1/4 in	0.7-3.5 N·m	0.1 N·m	336,31	1	7454-3.5*
1/4 in	1.68-8.4 N·m	0.2 N·m	336,31	1	7454-8.4*
3/8 in	3.4-17 N·m	0.5 N·m	336,31	1	7454-17*
3/8 in	6.4-32 N·m	0.5 N·m	251,63	1	7454-32*
3/8 in	14-70 N·m	1 N·m	357,52	1	7454-70A*
1/2 in	28-140 N·m	5 N·m	479,53	1	7454-140A*
1/2 in	46-230 N·m	10 N·m	488,01	1	7454-230*
3/4 in	160-800 N·m	20 N·m	859,33	1	7454-800A*

Llave mecánica de par ajustable con cabeza de carraca fija



**76R3-1500**

			€		
3/4 in	700-1500 N·m	25 N·m	1.581,38	1	76R3-1500



Llave dinamométrica mecánica de dial, cuadradillo fijo y mango de metal

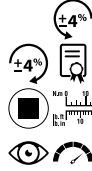

**7454-480/7454-800**

			€		
3/4 in	100-480 N·m	10 N·m	1.058,50	1	7454-480*

Llave dinamométrica mecánica con dial, cuadradillo fijo y mango de dos secciones

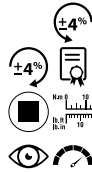

**7454-1400**

			€		
1 in	275-1400 N·m	25 N·m	2.411,07	1	7454-1400*

Llave dinamométrica mecánica con dial/LED y cuadradillo fijo



**7454-800E**

			€		
3/4 in	160-800 N·m	20 N·m	1.764,18	1	7454-800E*

Llave dinamométrica mecánica con dial/LED, cuadradillo fijo y mango de dos secciones



**7454-1400E**

			€		
1 in	275-1400 N·m	25 N·m	3.929,34	1	7454-1400E*

Llave dinamométrica mecánica de disparo prefijada con cabeza fija de carraca



**74PR-20**

			€		
1/4 in	4-20 N·m	219 mm	201,31	1	74PR-20

El prefijado de la llave tiene un sobre coste de 25,00 € e incluye certificado de calibración

Llave dinamométrica mecánica de disparo prefijada con cabeza fija de carraca con cuadradillo por ambos lados



**74PR-60/74PR-400**

			€		
3/8 in	12-60 N·m	295 mm	211,37	1	74PR-60
1/2 in	12-60 N·m	301 mm	211,37	1	74PR-60A
3/8 in	20-100 N·m	335 mm	216,40	1	74PR-100
1/2 in	20-100 N·m	342 mm	216,40	1	74PR-100A
1/2 in	40-200 N·m	425 mm	220,18	1	74PR-200
1/2 in	60-300 N·m	668 mm	264,22	1	74PR-300
3/4 in	80-400 N·m	675 mm	308,25	1	74PR-400

El prefijado de la llave tiene un sobre coste de 15,00 € e incluye certificado de calibración

\* Hasta agotar existencias



Llave dinamométrica mecánica prefijada con cabeza intercambiable de conexión rectangular y mango de plástico



### 74P9-20

mm	N·m	L	€		
9x12 mm	4-20 N·m	205 mm	201,31	1	74P9-20

El prefijado de la llave tiene un sobre coste de 25,00 € e incluye certificado de calibración

Llave dinamométrica mecánica prefijada con cabeza intercambiable de conexión rectangular y mango de goma



### 74P9-60/74P14-400

mm	N·m	L	€		
9x12 mm	12-60 N·m	286 mm	201,31	1	74P9-60
9x12 mm	20-100 N·m	326 mm	195,02	1	74P9-100
14x18 mm	40-200 N·m	403 mm	195,02	1	74P14-200
14x18 mm	60-300 N·m	534 mm	301,97	1	74P14-300
14x18 mm	80-400 N·m	652 mm	314,54	1	74P14-400

El prefijado de la llave tiene un sobre coste de 25,00 € e incluye certificado de calibración

Llave dinamométrica mecánica prefijada con cabeza intercambiable de conexión cilíndrica y mango de plástico

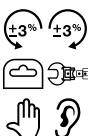

### 74PS-20

mm	N·m	L	€		
16 mm	4-20 N·m	206 mm	201,31	1	74PS-20

El prefijado de la llave tiene un sobre coste de 25,00 € e incluye certificado de calibración

Llave dinamométrica mecánica prefijada con cabeza intercambiable de conexión cilíndrica y mango de goma



### 74PS-60/74PS-300

mm	N·m	L	€		
16 mm	12-60 N·m	283 mm	201,31	1	74PS-60
16 mm	20-100 N·m	324 mm	195,02	1	74PS-100
16 mm	40-200 N·m	405 mm	195,02	1	74PS-200
16 mm	60-300 N·m	643 mm	301,97	1	74PS-300

El prefijado de la llave tiene un sobre coste de 25,00 € e incluye certificado de calibración

Llave dinamométrica mecánica de disparo de accionamiento libre prefijada con cabeza fija de carraca



### 75P3/75P1

mm	N·m	L	€		
3/4 in	130-650 N·m	848 mm	1.119,79	1	75P3-650
3/4" in	200-800 N·m	1030 mm	1.226,73	1	75P3-800
3/4" in	300-1000 N·m	1238 mm	1.497,23	1	75P3-1000
1" in	500-1500 N·m	1563 mm	1.623,05	1	75P1-1500

El prefijado de la llave tiene un sobre coste de 25,00 € e incluye certificado de calibración

Llave dinamométrica mecánica de disparo de accionamiento libre prefijada con cabeza con conexión cilíndrica intercambiable



### 75PS-650

mm	N·m	L	€		
22 mm	130-650 N·m	800 mm	1.094,62	1	75PS-650

El prefijado de la llave tiene un sobre coste de 25,00 € e incluye certificado de calibración

Extensión para llaves de serie 75



**75EXT**

			€		
700 mm	60 mm	1.600 kg	245,35	1	75EXT

Destornillador dinamoétrico angular electrónico



**TAS14**

			€		
1/4" in		0.04-0.7 N·m	729,09	1	TAS14H007
- in	1/4" in	0.04-0.7 N·m	729,09	1	TAS14S007
1/4" in		0.45-9 N·m	748,61	1	TAS14H09
	1/4" in	0.45-9 N·m	748,61	1	TAS14S09

PRECISIÓN: 20% a 100% de escala completa

**DESTORNILLADORES DINAMOMÉTRICOS**

Destornillador digital de par y ángulo Bluetooth®



**TASMB14H**

			€		
1/4 in	0.04-0.7 N·m	0.01 N·m	1.655,19	1	TASMB14H007
1/4 in	0.45-9 N·m	0.01 N·m	1.693,69	1	TASMB14H09

Precisión: 20% a 100% de escala completa

Destornillador dinamoétrico ajustable con visor de escala



**6973N-6978N**

			€		
1/4 in	16-80 cNM	1 cNM	305,91	1	6973N
1/4 in	40-200 cNM	2 cNM	313,02	1	6976N
1/4 in	90-450 cNM	5 cNM	319,93	1	6978N

Destornillador dinamoétrico digital con memoria y USB



**TASM14H**

		€		
1/4 in	0.035-0.700 N·m	1.124,55	1	TASM14H007
1/4 in	0.45-9 N·m	1.156,38	1	TASM14H09

Mini llave dinamoétrica ajustable con punta fija



**6852-5**

			€		
1/4 in	1-5 N·m	0.1 N·m	279,33	1	6852-5



Set de mini llave dinamoétrica ajustable con punta fija



**6852-5/S17**

		€		
32 x 70 x 200 mm	0.29 kg	306,60	1	6852-5/S17

6852-5		
6700SM-4		
59S/PH0, 59S/PH1		
59S/PZ0, 59S/PZ1		
59S/H1.5		
59S/0.8-5.5, 59S/0.6-4.5		
59S/T6, 59S/T7, 59S/T8		

Destornillador dinamoétrico ajustable con escala marcada en cN.m



**TSS120**

			€		
1/4 in	10-120 cN.M	1 cN.M	225,69	1	TSS120

Destornillador dinamoétrico ajustable con escala marcada en N.m



**TSS600**

			€		
1/4 in	1-6 N.m	0.1 N.m	225,69	1	TSS600

Destornillador dinamoétrico preajustable



**6873N-6880N**

			€		
7-70 cNM	1/4 in	1/4 in	281,78	1	6876N
15-170 cNM	1/4 in	1/4 in	288,81	1	6878N
45-450 cNM	1/4 in	1/4 in	319,92	1	6880N

El prefijado de la llave tiene un sobre coste de 25,00 € e incluye certificado de calibración

Mini llave dinamoétrica prefijada con punta fija



**6852P-5**

			€		
1/4" in	1-5 N-m	157 mm	314,54	1	6852P-5

El prefijado de la llave tiene un sobre coste de 25,00 € e incluye certificado de calibración

Destornillador dinamoétrico ERGO™ de par prefijado



**BE-6990**

		€		
0.6 N-m	T6 IP6	61,62	1	BE-6990-IP6
0.9 N-m	T7 IP7	61,62	1	BE-6990-IP7
1.2 N-m	T8 IP8	61,62	1	BE-6990-IP8
1.4 N-m	T9 IP9	61,62	1	BE-6990-IP9
2 N-m	T10 IP10	61,62	1	BE-6990-IP10
3 N-m	T15 IP15	61,62	1	BE-6990-IP15

Juego de destornillador dinamométrico par prefijado ERGO™ con varillas intercambiables



ergo®



**BE-6990-IPSET**

		€		
40 x 170 x 215 mm	0.755 kg	212,22	1	BE-6990-IPSET

Varilla TORX Plus para destornillador dinamométrico BE-6990



**BE-6990-IP20-KL**

			€		
IP20	4.5 mm	90 mm	6,23	10	BE-6990-IP20-KL

Varilla de recambio para puntas TORX®



**BE-6990TX-T20KL**

			€		
T20	4.5 mm	92 mm	7,68	10	BE-6990TX-T20KL

Varilla TORX para destornillador dinamométrico BE-6990



**BE-6990TX-KL**

			€		
T6	1.70 mm	160 mm	7,68	10	BE-6990TX-T6-KL
T7	1.99 mm	160 mm	7,68	10	BE-6990TX-T7-KL
T8	2.31 mm	160 mm	7,68	10	BE-6990TX-T8-KL
T9	2.50 mm	170 mm	7,68	10	BE-6990TX-T9-KL
T10	2.74 mm	170 mm	7,68	10	BE-6990TX-T10KL
T15	3.27 mm	170 mm	7,68	10	BE-6990TX-T15KL

Varilla TORX Plus para destornillador dinamométrico BE-6990



**BE-6990-IP-KL**

			€		
IP6	1.50 mm	170 mm	7,74	10	BE-6990-IP6-KL
IP7	1.99 mm	170 mm	7,74	10	BE-6990-IP7-KL
IP8	2.31 mm	170 mm	7,74	10	BE-6990-IP8-KL
IP9	2.50 mm	170 mm	7,74	10	BE-6990-IP9-KL
IP10	2.74 mm	170 mm	7,74	10	BE-6990-IP10-KL
IP15	3.27 mm	170 mm	7,74	10	BE-6990-IP15-KL

**MULTIPLICADORES**

Multiplicador de par manual con compensación con brazos de reacción recto y acodado



**89049TM-1000**

			€		
1000 Nm - 3/4 in	5:1	200 Nm - 1/2 in	1.623,05	1	89049TM-1000





Multiplicador de par manual con compensación con brazos de reacción recto y acodado



### 8905-TM/9505-TM

in	Ratio	in	€	Icons
1300 Nm - 3/4 in	5:1	260 Nm - 1/2 in	1.538,48	1 8905-TM
2700 Nm - 1 in	5:1	540 Nm - 3/4 in	1.538,48	1 9505-TM

Multiplicador de par manual con placa de reacción



### 9505

in	Ratio	in	€	Icons
3400 Nm - 1 in	5.2:1	680 Nm - 3/4 in	4.007,39	1 9505-3400

Multiplicador de par manual con placa de reacción y sistema de bloqueo de carraca



### 9525-9625

in	Ratio	in	€	Icons
3400 Nm - 1 in	27:1	125 Nm - 1/2 in	7.425,05	1 9525-3400
9500 Nm - 1.1/2 in	27:1	380 Nm - 3/4 in	6.630,63	1 9625-9500

Multiplicador de par manual con brazo de reacción recto



### 95155B/9526B

in	Ratio	in	€	Icons
3000 Nm - 1 in	15.5:1	193 Nm - 1/2 in	4.466,54	1 95155B-3000
4500 Nm - 1 in	27:1	166 Nm - 1/2 in	4.655,28	1 9526B-4500

Multiplicador de par manual compacto con brazo de reacción acodado



### 89222CR/96255CR

in	Ratio	in	€	Icons
1000 Nm - 3/4 in	22.2:1	45 Nm - 1/2 in	3.145,46	1 89222CR-1000
2000 Nm - 1 in	27:1	74 Nm - 1/2 in	3.460,01	1 9527CR-2000
4000 Nm - 1 in	25:1	160 Nm - 1/2 in	5.020,15	1 9525CR-4000
7000 Nm - 1.1/2 in	25.5:1	274 Nm - 1/2 in	6.284,62	1 96255CR-7000

## COMPROBADORES DE PAR

Comprobadores multifunción para llaves y destornilladores dinamométricos



### TEA003-TEA030

Nm	in	Nm	€	Icons
0.1-3.0 N·m	1/4 in	0.01 N·m	1.615,51	1 TEA003
0.5-10 N·m	1/4 in	0.01 N·m	1.615,51	1 TEA010
1.5-30 N·m	10 mm	0.1 N·m	1.538,31	1 TEA030A



Simuladores de Juntas para comprobadores de par



### TJS

mm	in	mm	€	Icons
3 N·m	1/4 in	31 mm	298,11	1 TJS003
10 N·m	1/4 in	31 mm	304,48	1 TJS010
30 N·m	1/4 in	31 mm	322,51	1 TJS030

## Comprobador multifunción para llaves dinámicas



### TEA065-TEA2100

mm	in	€		
3-65 N·m	- mm	3/8 in	1.521,27	1 TEA065
10-350 N·m	- mm	1/2 in	1.503,52	1 TEA350
50-1100 N·m	27 mm	3/4 in	2.019,38	1 TEA1100
200-2100 N·m	27 mm		2.517,50	1 TEA2100

## ADAPTADORES DE PAR Y ÁNGULO

Adaptador electrónico de ángulo y par



### TAM

mm	€		
1/4 in	1,5-30 N·m	373,20	1 TAM1430
3/8 in	6,8-135 N·m	373,20	1 TAM38135
1/2 in	6,8-135 N·m	416,17	1 TAM12135
1/2 in	10-200 N·m	416,17	1 TAM12200
1/2 in	17-340 N·m	509,47	1 TAM12340

1/4" (TAM1430); 3/8" (TAM38135) 1/2" (TAM12135, 12200, 12340)

## Goniómetro electrónico



### MAM

mm	€		
0-360°	56 mm	256,22	1 MAM50M

Señal visual y de audio con 1 LED roja y 5 verdes

## Goniómetro con imán



### 7851-M/8951-M

mm	€		
1/2 in	0-360	490 mm	159,12
3/4 in	0-360	490 mm	245,04

## Goniómetro con pinza



### 7851-G

mm	€		
1/2 in	0-360	555 mm	178,08

## HERRAMIENTAS DE INSERCIÓN

Cabeza intercambiable redonda de carraca reversible con conector rectangular



### 9/14/24/27R





mm	mm	max	€		
1/4 in	9x12 mm	30 N·m	64,52	1	9R-1/4
3/8 in	9x12 mm	135 N·m	67,11	1	9R-3/8
1/2 in	9x12 mm	160 N·m	68,40	1	9R-1/2
1/2 in	14x18 mm	340 N·m	72,28	1	14R-1/2
3/4 in	14x18 mm	420 N·m	116,14	1	14R-3/4
3/4 in	24x32 mm	1000 N·m	187,13	1	24R-3/4
1 in	24x32 mm	1200 N·m	309,72	1	24R-1
1 in	27x36 mm	2500 N·m	354,90	1	27R-1



Cabeza intercambiable con cuadradillo pasante de carraca con conector rectangular







**9/14/24/27T**

			€		
1/4 in	9x12 mm	30 N·m	<b>72,28</b>	1	9T-1/4
3/8 in	9x12 mm	135 N·m	<b>77,44</b>	1	9T-3/8
1/2 in	9x12 mm	160 N·m	<b>82,59</b>	1	9T-1/2
1/2 in	14x18 mm	340 N·m	<b>92,92</b>	1	14T-1/2
3/4 in	14x18 mm	420 N·m	<b>167,77</b>	1	14T-3/4
3/4 in	24x32 mm	1000 N·m	<b>283,91</b>	1	24T-3/4
1 in	24x32 mm	1200 N·m	<b>374,26</b>	1	24T-1
1 in	27x36 mm	2500 N·m	<b>412,97</b>	1	27T-1

Cabeza intercambiable cuadrada fija con conector rectangular







**9/14/24/27F**





			€		
1/4 in	9x12 mm	30 N·m	<b>40,02</b>	1	9F-1/4
3/8 in	9x12 mm	135 N·m	<b>40,02</b>	1	9F-3/8
1/2 in	9x12 mm	160 N·m	<b>41,29</b>	1	9F-1/2
1/2 in	14x18 mm	340 N·m	<b>43,88</b>	1	14F-1/2
3/4 in	14x18 mm	420 N·m	<b>73,56</b>	1	14F-3/4
3/4 in	24x32 mm	1000 N·m	<b>237,46</b>	1	24F-3/4
1 in	24x32 mm	1200 N·m	<b>277,46</b>	1	24F-1
1 in	27x36 mm	2500 N·m	<b>329,10</b>	1	27F-1

Cabeza intercambiable de carraca tipo pera con conector rectangular



**9/14P**





			€		
1/4 in	9x12 mm	30 N·m	<b>86,48</b>	1	9P-1/4
3/8 in	9x12 mm	135 N·m	<b>89,05</b>	1	9P-3/8

			€		
1/2 in	9x12 mm	160 N·m	<b>91,63</b>	1	9P-1/2
1/2 in	14x18 mm	340 N·m	<b>103,25</b>	1	14P-1/2

Cabeza intercambiable de carraca tipo pera con liberación rápida y conector rectangular







**9/14Q**

			€		
1/4 in	9x12 mm	30 N·m	<b>100,65</b>	1	9Q-1/4
3/8 in	9x12 mm	135 N·m	<b>103,25</b>	1	9Q-3/8
1/2 in	9x12 mm	160 N·m	<b>105,82</b>	1	9Q-1/2
1/2 in	14x18 mm	340 N·m	<b>113,57</b>	1	14Q-1/2

Cabeza intercambiable de carraca portapuntas con conector rectangular



**9B**

		€		
1/4 in	9x12 mm	<b>61,93</b>	1	9B-1/4
5/16 in	9x12 mm	<b>83,88</b>	1	9B-5/16

Cabeza intercambiable de boca fija con conector rectangular métrica



9/14/24/277

			€		
7 mm	9x12 mm	9 N·m	28,39	1	97-7
8 mm	9x12 mm	13 N·m	28,39	1	97-8
9 mm	9x12 mm	18 N·m	28,39	1	97-9
10 mm	9x12 mm	24 N·m	28,39	1	97-10
11 mm	9x12 mm	32 N·m	28,39	1	97-11
12 mm	9x12 mm	41 N·m	28,39	1	97-12
13 mm	9x12 mm	51 N·m	28,39	1	97-13
14 mm	9x12 mm	63 N·m	28,38	1	97-14
15 mm	9x12 mm	77 N·m	28,38	1	97-15
16 mm	9x12 mm	92 N·m	28,39	1	97-16
17 mm	9x12 mm	109 N·m	28,39	1	97-17
18 mm	9x12 mm	125 N·m	28,39	1	97-18
19 mm	9x12 mm	145 N·m	28,39	1	97-19
21 mm	9x12 mm	160 N·m	47,59	1	97-21
22 mm	9x12 mm	160 N·m	54,82	1	97-22
24 mm	9x12 mm	160 N·m	54,82	1	97-24
27 mm	9x12 mm	160 N·m	50,22	1	97-27
30 mm	9x12 mm	160 N·m	49,05	1	97-30
32 mm	9x12 mm	160 N·m	49,05	1	97-32
13 mm	14x18 mm	51 N·m	32,27	1	147-13
14 mm	14x18 mm	63 N·m	32,27	1	147-14
15 mm	14x18 mm	77 N·m	32,27	1	147-15
16 mm	14x18 mm	92 N·m	32,27	1	147-16
17 mm	14x18 mm	109 N·m	32,27	1	147-17
18 mm	14x18 mm	125 N·m	32,27	1	147-18
19 mm	14x18 mm	145 N·m	32,27	1	147-19
21 mm	14x18 mm	190 N·m	38,71	1	147-21
22 mm	14x18 mm	220 N·m	38,71	1	147-22
24 mm	14x18 mm	280 N·m	38,71	1	147-24
25 mm	14x18 mm	320 N·m	43,88	1	147-25
27 mm	14x18 mm	360 N·m	43,88	1	147-27
30 mm	14x18 mm	360 N·m	43,88	1	147-30
32 mm	14x18 mm	360 N·m	43,88	1	147-32
33 mm	14x18 mm	360 N·m	47,76	1	147-33
34 mm	14x18 mm	360 N·m	47,76	1	147-34
35 mm	14x18 mm	360 N·m	47,76	1	147-35
36 mm	14x18 mm	360 N·m	47,76	1	147-36
37 mm	14x18 mm	360 N·m	50,34	1	147-37
38 mm	14x18 mm	360 N·m	50,34	1	147-38
39 mm	14x18 mm	360 N·m	50,34	1	147-39
41 mm	14x18 mm	360 N·m	50,34	1	147-41
45 mm	14x18 mm	360 N·m	178,10	1	147-45
46 mm	14x18 mm	360 N·m	178,10	1	147-46
50 mm	14x18 mm	360 N·m	184,55	1	147-50
55 mm	14x18 mm	360 N·m	198,74	1	147-55
60 mm	14x18 mm	360 N·m	212,93	1	147-60
65 mm	14x18 mm	360 N·m	217,48	1	147-65
68 mm	14x18 mm	360 N·m	240,03	1	147-68
70 mm	14x18 mm	360 N·m	240,03	1	147-70
75 mm	14x18 mm	360 N·m	281,32	1	147-75
90 mm	14x18 mm	360 N·m	356,18	1	147-90
24 mm	24x32 mm	1200 N·m	197,46	1	247-24
27 mm	24x32 mm	1200 N·m	197,46	1	247-27

			€		
30 mm	24x32 mm	1200 N·m	200,05	1	247-30
32 mm	24x32 mm	1200 N·m	200,05	1	247-32
34 mm	24x32 mm	1200 N·m	200,05	1	247-34
36 mm	24x32 mm	1200 N·m	205,20	1	247-36
41 mm	24x32 mm	1200 N·m	205,20	1	247-41
46 mm	24x32 mm	1200 N·m	209,06	1	247-46
50 mm	24x32 mm	1200 N·m	214,22	1	247-50
55 mm	24x32 mm	1200 N·m	220,69	1	247-55
60 mm	24x32 mm	1200 N·m	224,55	1	247-60
30 mm	27x36 mm	3000 N·m	220,69	1	277-30
32 mm	27x36 mm	3000 N·m	220,69	1	277-32
34 mm	27x36 mm	3000 N·m	220,69	1	277-34
36 mm	27x36 mm	3000 N·m	225,84	1	277-36
41 mm	27x36 mm	3000 N·m	247,78	1	277-41
46 mm	27x36 mm	3000 N·m	252,94	1	277-46
50 mm	27x36 mm	3000 N·m	259,41	1	277-50
55 mm	27x36 mm	3000 N·m	267,13	1	277-55
60 mm	27x36 mm	3000 N·m	272,30	1	277-60

Cabeza intercambiable de boca fija con conector rectangular pulgadas



9/14/24/277"





			€		
1/4 in	9x12 mm	6 N·m	29,69	1	97-1/4
5/16 in	9x12 mm	13 N·m	29,69	1	97-5/16
3/8 in	9x12 mm	24 N·m	29,69	1	97-3/8
7/16 in	9x12 mm	32 N·m	29,69	1	97-7/16
1/2 in	9x12 mm	51 N·m	29,69	1	97-1/2
17/32 in	9x12 mm	63 N·m	29,69	1	97-17/32
9/16 in	9x12 mm	77 N·m	29,69	1	97-9/16
5/8 in	9x12 mm	92 N·m	29,69	1	97-5/8
11/16 in	9x12 mm	125 N·m	29,69	1	97-11/16
3/4 in	9x12 mm	145 N·m	29,69	1	97-3/4
13/16 in	9x12 mm	160 N·m	46,46	1	97-13/16
7/8 in	9x12 mm	160 N·m	46,46	1	97-7/8
15/16 in	9x12 mm	160 N·m	49,05	1	97-15/16
1 in	9x12 mm	160 N·m	49,05	1	97-1
7/16 in	14x18 mm	32 N·m	36,13	1	147-7/16
1/2 in	14x18 mm	51 N·m	36,13	1	147-1/2
9/16 in	14x18 mm	77 N·m	36,13	1	147-9/16
5/8 in	14x18 mm	92 N·m	36,13	1	147-5/8
11/16 in	14x18 mm	109 N·m	36,13	1	147-11/16
3/4 in	14x18 mm	145 N·m	36,13	1	147-3/4
13/16 in	14x18 mm	190 N·m	41,29	1	147-13/16
7/8 in	14x18 mm	220 N·m	41,29	1	147-7/8
15/16 in	14x18 mm	280 N·m	41,29	1	147-15/16
1 in	14x18 mm	360 N·m	41,29	1	147-1
1 1/8 in	14x18 mm	360 N·m	41,29	1	147-1.1/8
1 1/4 in	14x18 mm	360 N·m	43,88	1	147-1.1/4



Cabeza intercambiable de boca estrella con conector rectangular métrica







9/14/24/278

 mm	 mm	 máx	€		
7 mm	9x12 mm	25 N·m	30,98	1	98-7
8 mm	9x12 mm	34 N·m	30,98	1	98-8
9 mm	9x12 mm	45 N·m	30,98	1	98-9
10 mm	9x12 mm	58 N·m	30,98	1	98-10
11 mm	9x12 mm	47 N·m	30,98	1	98-11
12 mm	9x12 mm	89 N·m	30,98	1	98-12
13 mm	9x12 mm	105 N·m	30,98	1	98-13
14 mm	9x12 mm	125 N·m	30,98	1	98-14
15 mm	9x12 mm	145 N·m	30,98	1	98-15
16 mm	9x12 mm	160 N·m	30,98	1	98-16
17 mm	9x12 mm	160 N·m	30,98	1	98-17
18 mm	9x12 mm	160 N·m	30,98	1	98-18
19 mm	9x12 mm	160 N·m	30,98	1	98-19
21 mm	9x12 mm	160 N·m	30,98	1	98-21
22 mm	9x12 mm	160 N·m	30,98	1	98-22
13 mm	14x18 mm	105 N·m	33,55	1	148-13
14 mm	14x18 mm	125 N·m	33,55	1	148-14
15 mm	14x18 mm	150 N·m	33,55	1	148-15
16 mm	14x18 mm	175 N·m	33,55	1	148-16
17 mm	14x18 mm	200 N·m	33,55	1	148-17
18 mm	14x18 mm	230 N·m	33,55	1	148-18
19 mm	14x18 mm	260 N·m	33,55	1	148-19
21 mm	14x18 mm	330 N·m	38,71	1	148-21
22 mm	14x18 mm	360 N·m	38,71	1	148-22
24 mm	14x18 mm	360 N·m	38,71	1	148-24
27 mm	14x18 mm	360 N·m	38,71	1	148-27
28 mm	14x18 mm	360 N·m	43,88	1	148-28
30 mm	14x18 mm	360 N·m	43,88	1	148-30
32 mm	14x18 mm	360 N·m	43,88	1	148-32
34 mm	14x18 mm	360 N·m	47,76	1	148-34
36 mm	14x18 mm	360 N·m	47,76	1	148-36
41 mm	14x18 mm	360 N·m	47,76	1	148-41
24 mm	24x32 mm	1200 N·m	201,32	1	248-24
27 mm	24x32 mm	1200 N·m	201,32	1	248-27
30 mm	24x32 mm	1200 N·m	206,48	1	248-30
32 mm	24x32 mm	1200 N·m	206,48	1	248-32
34 mm	24x32 mm	1200 N·m	206,48	1	248-34
36 mm	24x32 mm	1200 N·m	210,36	1	248-36
41 mm	24x32 mm	1200 N·m	220,69	1	248-41
46 mm	24x32 mm	1200 N·m	215,53	1	248-46
50 mm	24x32 mm	1200 N·m	215,53	1	248-50
55 mm	24x32 mm	1200 N·m	263,26	1	248-55
60 mm	24x32 mm	1200 N·m	263,26	1	248-60
30 mm	27x36 mm	3000 N·m	250,35	1	278-30
32 mm	27x36 mm	1240 N·m	250,35	1	278-32
34 mm	27x36 mm	3000 N·m	250,35	1	278-34
36 mm	27x36 mm	3000 N·m	254,22	1	278-36
41 mm	27x36 mm	3000 N·m	267,13	1	278-41
46 mm	27x36 mm	3000 N·m	260,68	1	278-46
50 mm	27x36 mm	3000 N·m	260,68	1	278-50
55 mm	27x36 mm	3000 N·m	263,26	1	278-55
60 mm	27x36 mm	3000 N·m	263,26	1	278-60

Cabeza intercambiable de boca estrella con conector rectangular pulgadas







9/14/24/278"

 in	 mm	 máx	€		
1/4 in	9x12 mm	25 N·m	30,98	1	98-1/4
5/16 in	9x12 mm	34 N·m	30,98	1	98-5/16
3/8 in	9x12 mm	58 N·m	30,98	1	98-3/8
7/16 in	9x12 mm	72 N·m	30,98	1	98-7/16
1/2 in	9x12 mm	105 N·m	30,98	1	98-1/2
9/16 in	9x12 mm	125 N·m	30,98	1	98-9/16
5/8 in	9x12 mm	160 N·m	30,98	1	98-5/8
11/16 in	9x12 mm	160 N·m	30,98	1	98-11/16
3/4 in	9x12 mm	57 N·m	30,98	1	98-3/4
13/16 in	14x18 mm	330 N·m	43,88	1	148-13/16
7/8 in	9x12 mm	160 N·m	32,27	1	98-7/8
1/2 in	14x18 mm	105 N·m	36,13	1	148-1/2
9/16 in	14x18 mm	150 N·m	36,13	1	148-9/16
5/8 in	14x18 mm	175 N·m	36,13	1	148-5/8
11/16 in	14x18 mm	230 N·m	36,13	1	148-11/16
3/4 in	14x18 mm	260 N·m	36,13	1	148-3/4
15/16 in	14x18 mm	360 N·m	43,88	1	148-15/16
7/8 in	14x18 mm	360 N·m	43,88	1	148-7/8
1 in	14x18 mm	360 N·m	43,88	1	148-1

Cabeza intercambiable para racores con conector rectangular



99 in

 in	 mm	 máx	€		
3/8 in	9x12 mm	9 N·m	34,86	1	99-3/8
7/16 in	9x12 mm	16 N·m	34,86	1	99-7/16
1/2 in	9x12 mm	28 N·m	34,86	1	99-1/2
9/16 in	9x12 mm	31 N·m	34,86	1	99-9/16
5/8 in	9x12 mm	46 N·m	34,86	1	99-5/8
11/16 in	9x12 mm	65 N·m	36,13	1	99-11/16
3/4 in	9x12 mm	74 N·m	36,13	1	99-3/4



Cabeza intercambiable para racores con conector rectangular



**99**

mm	mm	max	€		
10 mm	9x12 mm	14 N·m	32,27	1	99-10
11 mm	9x12 mm	19 N·m	32,27	1	99-11
12 mm	9x12 mm	24 N·m	32,27	1	99-12
13 mm	9x12 mm	30 N·m	32,27	1	99-13
14 mm	9x12 mm	37 N·m	32,27	1	99-14
16 mm	9x12 mm	46 N·m	33,55	1	99-16
17 mm	9x12 mm	55 N·m	33,55	1	99-17
18 mm	9x12 mm	65 N·m	33,55	1	99-18
19 mm	9x12 mm	74 N·m	33,55	1	99-19
21 mm	9x12 mm	87 N·m	33,55	1	99-21
22 mm	9x12 mm	96 N·m	33,55	1	99-22
24 mm	9x12 mm	96 N·m	37,43	1	99-24

Adaptador para cabezas intercambiables con conector rectangular



**9/14/24/27A**

mm	mm	max	€		
9x12 mm	14x18 mm	160 N·m	60,66	1	9A-14
14x18 mm	9x12 mm	160 N·m	77,44	1	14A-9
14x18 mm	24x32 mm	360 N·m	105,82	1	14A-32
24x32 mm	14x18 mm	360 N·m	114,86	1	24A-14
24x32 mm	27x36 mm	1200 N·m	181,97	1	24A-27
27x36 mm	24x32 mm	1200 N·m	215,53	1	27A-24

Cabeza intercambiable para soldar con conector rectangular



**9/14/24W**

mm	L	€		
9x12 mm	23.8 mm	41,67	1	9W
14x18 mm	38 mm	43,88	1	14W
24x32 mm	65 mm	70,99	1	24W

Cabeza de carraca redonda intercambiable con conector cilindrico



**16R/22R**

	mm	max	€		
1/4" in	16 mm	20 N·m	104,04	1	16R-1/4
3/8" in	16 mm	160 N·m	104,04	1	16R-3/8
1/2" in	16 mm	420 N·m	104,04	1	16R-1/2
3/4" in	22 mm	1200 N·m	264,22	1	22R-3/4

Cabeza intercambiable de cuadradillo pasante con conector cilindrico



**16F/22F**





	mm	max	€		
1/4" in	16 mm	20 N·m	81,93	1	16F-1/4
3/8" in	16 mm	160 N·m	81,93	1	16F-3/8
1/2" in	16 mm	420 N·m	81,93	1	16F-1/2
3/4" in	22 mm	1200 N·m	258,51	1	22F-3/4



Cabeza intercambiable llave fija mm con conector cilíndrico







**167/227**

			€		
mm	mm	N·m			
7 mm	16 mm	9 N·m	<b>54,09</b>	1	167-7
8 mm	16 mm	13 N·m	<b>54,09</b>	1	167-8
9 mm	16 mm	18 N·m	<b>54,09</b>	1	167-9
10 mm	16 mm	24 N·m	<b>54,09</b>	1	167-10
11 mm	16 mm	32 N·m	<b>54,09</b>	1	167-11
12 mm	16 mm	41 N·m	<b>55,89</b>	1	167-12
13 mm	16 mm	51 N·m	<b>55,89</b>	1	167-13
14 mm	16 mm	63 N·m	<b>55,89</b>	1	167-14
15 mm	16 mm	77 N·m	<b>55,89</b>	1	167-15
16 mm	16 mm	92 N·m	<b>57,30</b>	1	167-16
17 mm	16 mm	109 N·m	<b>57,30</b>	1	167-17
18 mm	16 mm	125 N·m	<b>61,73</b>	1	167-18
19 mm	16 mm	145 N·m	<b>67,07</b>	1	167-19
20 mm	16 mm	160 N·m	<b>67,32</b>	1	167-20
21 mm	16 mm	190 N·m	<b>72,87</b>	1	167-21
22 mm	16 mm	220 N·m	<b>91,12</b>	1	167-22
23 mm	16 mm	250 N·m	<b>91,12</b>	1	167-23
24 mm	16 mm	280 N·m	<b>91,12</b>	1	167-24
25 mm	16 mm	320 N·m	<b>110,12</b>	1	167-25
26 mm	16 mm	360 N·m	<b>110,12</b>	1	167-26
27 mm	16 mm	360 N·m	<b>110,12</b>	1	167-27
28 mm	16 mm	360 N·m	<b>110,12</b>	1	167-28
30 mm	16 mm	360 N·m	<b>110,12</b>	1	167-30
32 mm	16 mm	360 N·m	<b>110,12</b>	1	167-32
36 mm	16 mm	360 N·m	<b>136,53</b>	1	167-36
22 mm	22 mm	1200 N·m	<b>207,59</b>	1	227-22
24 mm	22 mm	1200 N·m	<b>213,76</b>	1	227-24
27 mm	22 mm	1200 N·m	<b>220,03</b>	1	227-27
30 mm	22 mm	1200 N·m	<b>229,02</b>	1	227-30
32 mm	22 mm	1200 N·m	<b>233,40</b>	1	227-32
34 mm	22 mm	1200 N·m	<b>257,63</b>	1	227-34
36 mm	22 mm	1200 N·m	<b>264,20</b>	1	227-36
41 mm	22 mm	1200 N·m	<b>286,34</b>	1	227-41
46 mm	22 mm	1200 N·m	<b>343,51</b>	1	227-46

Cabeza intercambiable llave fija pulgadas con conector cilíndrico







**167**





			€		
in	mm	N·m			
5/16 in	16 mm	34 N·m	<b>57,54</b>	1	167-5/16
3/8 in	16 mm	45 N·m	<b>57,54</b>	1	167-3/8
7/16 in	16 mm	72 N·m	<b>59,46</b>	1	167-7/16
1/2 in	16 mm	51 N·m	<b>59,46</b>	1	167-1/2
9/16 in	16 mm	77 N·m	<b>59,46</b>	1	167-9/16
5/8 in	16 mm	92 N·m	<b>60,92</b>	1	167-5/8
11/16 in	16 mm	109 N·m	<b>57,88</b>	1	167-11/16
3/4 in	16 mm	145 N·m	<b>67,96</b>	1	167-3/4
13/16 in	16 mm	190 N·m	<b>77,54</b>	1	167-13/16
7/8 in	16 mm	220 N·m	<b>96,90</b>	1	167-7/8
15/16 in	16 mm	280 N·m	<b>96,90</b>	1	167-15/16
1 in	16 mm	360 N·m	<b>117,12</b>	1	167-1
1.1/16 in	16 mm	360 N·m	<b>117,12</b>	1	167-1.1/16
1.1/8 in	16 mm	360 N·m	<b>117,12</b>	1	167-1.1/8
1.3/16 in	16 mm	360 N·m	<b>117,12</b>	1	167-1.3/16
1.1/4 in	16 mm	360 N·m	<b>117,12</b>	1	167-1.1/4

Cabeza intercambiable de boca estrella con conector cilíndrico métrica



**168/228**

			€		
mm	mm	N·m			
7 mm	16 mm	25 N·m	<b>56,76</b>	1	168-7
8 mm	16 mm	34 N·m	<b>56,76</b>	1	168-8
9 mm	16 mm	45 N·m	<b>56,76</b>	1	168-9
10 mm	16 mm	58 N·m	<b>56,76</b>	1	168-10
11 mm	16 mm	72 N·m	<b>56,76</b>	1	168-11

			€		
mm	mm	N·m			
12 mm	16 mm	89 N·m	<b>58,66</b>	1	168-12
13 mm	16 mm	105 N·m	<b>58,66</b>	1	168-13
14 mm	16 mm	125 N·m	<b>58,66</b>	1	168-14
15 mm	16 mm	150 N·m	<b>58,66</b>	1	168-15
16 mm	16 mm	175 N·m	<b>60,15</b>	1	168-16
17 mm	16 mm	200 N·m	<b>60,15</b>	1	168-17
18 mm	16 mm	230 N·m	<b>64,75</b>	1	168-18
19 mm	16 mm	260 N·m	<b>67,07</b>	1	168-19
20 mm	16 mm	290 N·m	<b>70,70</b>	1	168-20
21 mm	16 mm	330 N·m	<b>76,46</b>	1	168-21
22 mm	16 mm	360 N·m	<b>95,63</b>	1	168-22
23 mm	16 mm	360 N·m	<b>95,63</b>	1	168-23
24 mm	16 mm	360 N·m	<b>95,63</b>	1	168-24
26 mm	16 mm	360 N·m	<b>115,67</b>	1	168-26
27 mm	16 mm	360 N·m	<b>115,67</b>	1	168-27
22 mm	22 mm	1200 N·m	<b>231,24</b>	1	228-22
24 mm	22 mm	1200 N·m	<b>231,24</b>	1	228-24
27 mm	22 mm	1200 N·m	<b>231,24</b>	1	228-27
30 mm	22 mm	1200 N·m	<b>240,43</b>	1	228-30
32 mm	22 mm	1200 N·m	<b>245,16</b>	1	228-32
34 mm	22 mm	1200 N·m	<b>263,64</b>	1	228-34
36 mm	22 mm	1200 N·m	<b>277,48</b>	1	228-36
41 mm	22 mm	1200 N·m	<b>300,58</b>	1	228-41
46 mm	22 mm	1200 N·m	<b>360,71</b>	1	228-46

Cabeza intercambiable de boca estrella con conector cilíndrico pulgadas







### 168

			€		
in	mm	N·m			
5/16 in	16 mm	34 N·m	<b>60,40</b>	1	168-5/16
3/8 in	16 mm	58 N·m	<b>60,40</b>	1	168-3/8
7/16 in	16 mm	89 N·m	<b>60,40</b>	1	168-7/16
1/2 in	16 mm	105 N·m	<b>62,37</b>	1	168-1/2
9/16 in	16 mm	125 N·m	<b>62,37</b>	1	168-9/16
5/8 in	16 mm	125 N·m	<b>63,97</b>	1	168-5/8
11/16 in	16 mm	125 N·m	<b>57,88</b>	1	168-11/16
3/4 in	16 mm	260 N·m	<b>75,21</b>	1	168-3/4
13/16 in	16 mm	290 N·m	<b>75,21</b>	1	168-13/16
7/8 in	16 mm	360 N·m	<b>101,73</b>	1	168-7/8
15/16 in	16 mm	360 N·m	<b>101,73</b>	1	168-15/16
1 in	16 mm	360 N·m	<b>123,00</b>	1	168-1
1.1/16 in	16 mm	360 N·m	<b>123,00</b>	1	168-1.1/16
1.3/16 in	16 mm	360 N·m	<b>144,30</b>	1	168-1.3/16

Cabeza intercambiable para racores con conector cilíndrico



### 169

			€		
mm	mm	N·m			
7 mm	16 mm	6 N·m	<b>59,63</b>	1	169-7
8 mm	16 mm	8 N·m	<b>59,63</b>	1	169-8
9 mm	16 mm	10 N·m	<b>59,63</b>	1	169-9
10 mm	16 mm	12 N·m	<b>59,63</b>	1	169-10
11 mm	16 mm	16 N·m	<b>59,63</b>	1	169-11
12 mm	16 mm	16 N·m	<b>61,68</b>	1	169-12
13 mm	16 mm	28 N·m	<b>61,68</b>	1	169-13
14 mm	16 mm	31 N·m	<b>61,68</b>	1	169-14
15 mm	16 mm	38 N·m	<b>61,68</b>	1	169-15
16 mm	16 mm	46 N·m	<b>63,09</b>	1	169-16
17 mm	16 mm	53 N·m	<b>63,09</b>	1	169-17
18 mm	16 mm	65 N·m	<b>68,04</b>	1	169-18
19 mm	16 mm	74 N·m	<b>70,45</b>	1	169-19
20 mm	16 mm	86 N·m	<b>74,16</b>	1	169-20
21 mm	16 mm	100 N·m	<b>80,33</b>	1	169-21
22 mm	16 mm	115 N·m	<b>100,49</b>	1	169-22
23 mm	16 mm	125 N·m	<b>100,49</b>	1	169-23
24 mm	16 mm	145 N·m	<b>100,49</b>	1	169-24
27 mm	16 mm	160 N·m	<b>121,35</b>	1	169-27

## JUEGOS DE MALETAS VACÍAS PARA HERRAMIENTAS DINAMOMÉTRICAS

Maletas vacías de doble pared que absorben los impactos para herramientas dinámicas



### 4750BMCT

	€		
kg			
0.95 kg	<b>27,58</b>	1	4750BMCT1







## Accesorios para herramientas eléctricas





## CORONAS DE SIERRA

Corona de sierra Sandflex® bi-metal



### 3830

	€		
14 mm	12,23	1	3830-14-C
16 mm	12,23	1	3830-16-C
17 mm	12,23	1	3830-17-C
19 mm	12,23	1	3830-19-C
20 mm	12,23	1	3830-20-C
21 mm	12,23	1	3830-21-C
22 mm	12,23	1	3830-22-C
24 mm	12,23	1	3830-24-C
25 mm	12,35	1	3830-25-C
27 mm	13,01	1	3830-27-C
29 mm	13,01	1	3830-29-C
30 mm	13,01	1	3830-30-C
32 mm	13,01	1	3830-32-C
33 mm	13,01	1	3830-33-C
35 mm	14,71	1	3830-35-C
37 mm	14,71	1	3830-37-C
38 mm	14,71	1	3830-38-C
40 mm	14,71	1	3830-40-C
41 mm	14,71	1	3830-41-C
43 mm	14,71	1	3830-43-C
44 mm	16,79	1	3830-44-C
46 mm	16,79	1	3830-46-C
48 mm	16,79	1	3830-48-C
50 mm	16,79	1	3830-50-C
51 mm	16,79	1	3830-51-C
52 mm	20,29	1	3830-52-C
54 mm	20,29	1	3830-54-C
55 mm	20,29	1	3830-55-C
56 mm	20,29	1	3830-56-C
57 mm	20,29	1	3830-57-C
59 mm	20,29	1	3830-59-C
60 mm	20,29	1	3830-60-C
64 mm	22,38	1	3830-64-C
65 mm	22,38	1	3830-65-C
67 mm	22,38	1	3830-67-C
68 mm	22,38	1	3830-68-C
70 mm	22,38	1	3830-70-C
73 mm	22,38	1	3830-73-C
76 mm	25,37	1	3830-76-C
79 mm	25,37	1	3830-79-C
83 mm	25,37	1	3830-83-C
86 mm	25,37	1	3830-86-C
89 mm	25,37	1	3830-89-C
92 mm	29,40	1	3830-92-C
95 mm	31,87	1	3830-95-C
98 mm	33,31	1	3830-98-C
102 mm	35,78	1	3830-102-C
105 mm	37,73	1	3830-105-C
108 mm	44,10	1	3830-108-C

	€		
111 mm	51,39	1	3830-111-C
114 mm	57,25	1	3830-114-C
121 mm	63,75	1	3830-121-C
127 mm	69,60	1	3830-127-C
133 mm	74,80	1	3830-133-C
140 mm	80,00	1	3830-140-C
146 mm	83,25	1	3830-146-C
152 mm	91,06	1	3830-152-C
14 mm	12,23	6	3830-14-VIP
16 mm	12,23	6	3830-16-VIP
17 mm	12,23	6	3830-17-VIP
19 mm	12,23	6	3830-19-VIP
20 mm	12,23	6	3830-20-VIP
21 mm	12,23	6	3830-21-VIP
22 mm	12,23	6	3830-22-VIP
24 mm	12,23	6	3830-24-VIP
25 mm	12,35	6	3830-25-VIP
27 mm	13,01	6	3830-27-VIP
29 mm	13,01	6	3830-29-VIP
30 mm	13,01	6	3830-30-VIP
32 mm	13,01	6	3830-32-VIP
33 mm	13,01	6	3830-33-VIP
35 mm	14,71	6	3830-35-VIP
37 mm	14,71	6	3830-37-VIP
38 mm	14,71	6	3830-38-VIP
40 mm	14,71	6	3830-40-VIP
41 mm	14,71	6	3830-41-VIP
43 mm	14,71	6	3830-43-VIP
44 mm	16,79	6	3830-44-VIP
46 mm	16,79	6	3830-46-VIP
48 mm	16,79	6	3830-48-VIP
50 mm	16,79	6	3830-50-VIP
51 mm	16,79	6	3830-51-VIP
52 mm	20,29	4	3830-52-VIP
54 mm	20,29	4	3830-54-VIP
55 mm	20,29	4	3830-55-VIP
56 mm	20,29	4	3830-56-VIP
57 mm	20,29	4	3830-57-VIP
59 mm	20,29	4	3830-59-VIP
60 mm	20,29	4	3830-60-VIP
62 mm	22,09	4	3830-62-VIP
64 mm	22,38	4	3830-64-VIP
65 mm	22,38	4	3830-65-VIP
67 mm	22,38	4	3830-67-VIP
68 mm	22,38	4	3830-68-VIP
70 mm	22,38	4	3830-70-VIP
73 mm	22,38	4	3830-73-VIP
76 mm	25,37	4	3830-76-VIP
79 mm	25,37	4	3830-79-VIP
83 mm	25,37	4	3830-83-VIP
86 mm	25,37	4	3830-86-VIP
89 mm	25,37	4	3830-89-VIP
92 mm	29,40	4	3830-92-VIP
95 mm	31,87	4	3830-95-VIP
98 mm	33,31	4	3830-98-VIP
102 mm	35,78	4	3830-102-VIP
105 mm	37,73	4	3830-105-VIP
108 mm	44,10	4	3830-108-VIP
111 mm	51,39	4	3830-111-VIP
114 mm	57,25	4	3830-114-VIP
121 mm	63,75	1	3830-121-VIP
127 mm	69,60	1	3830-127-VIP
133 mm	74,80	1	3830-133-VIP
140 mm	80,00	1	3830-140-VIP
146 mm	83,25	1	3830-146-VIP
152 mm	91,06	1	3830-152-VIP
168 mm	118,29	1	3830-168
177 mm	162,84	1	3830-177-HIGH
210 mm	177,44	1	3830-210

C: Clip / VIP: Embalaje industrial

Juego de 4 coronas Sandflex® bi-metales



### 3830-4P

		€		
4	19 mm	18,05	1	3830-19-4P
4	20 mm	19,23	1	3830-20-4P
4	22 mm	31,90	1	3830-22-4P
4	25 mm	35,15	1	3830-25-4P
4	27 mm	33,42	1	3830-27-4P
4	29 mm	33,70	1	3830-29-4P
4	30 mm	33,99	1	3830-30-4P
4	32 mm	36,09	1	3830-32-4P
4	35 mm	36,89	1	3830-35-4P

Juego de coronas bi-metales Sandflex®  
20x4mm + 25x4 mm



### 3834-CP-20/25

	€		
600 g	64,77	1	3834-CP-20/25

3830-20-Cx 4, 3830-25-Cx 4

3834-ARBR-930

3834-DRLx 2



Juego de coronas bi-metales Sandflex® 20 mm-76 mm



**3834-PROMO-82**

	€		
1188 g	93,93	1	3834-PROMO-82

- 3830-20-C, 3830-25-C, 3830-30-C, 3830-35-C, 3830-44-C, 3830-51-C, 3830-64-C, 3830-76-C
- 3834-ARBR-930
- 3834-ARBR-11152QC

Juego de coronas bi-metales Sandflex® 16 mm-44 mm



**3834-PROMO-122**

	€		
1100 g	113,30	1	3834-PROMO-122

- 3830-16-C, 3830-20-Cx 2, 3830-22-C, 3830-25-Cx 2, 3830-29-C, 3830-32-C, 3830-35-Cx 2, 3830-38-C, 3830-44-C
- 3834-ARBR-930
- 3834-ARBR-11152QC

Juego de coronas Sandflex™ bi-metales 19mm-76mm



**3834-PROMO-122-76**

	€		
1441 g	123,68	1	3834-PROMO-122-76

- 3830-19-C, 3830-20-C, 3830-22-C, 3830-25-C, 3830-27-C, 3830-32-C, 3830-35-C, 3830-38-C, 3830-40-C, 3830-51-C, 3830-64-C, 3830-76-C
- 3834-ARBR-930
- 3834-ARBR-9100

Juego de coronas bi-metales Sandflex® 35 mm-83 mm



**3834-SET-72-35/83**

	€		
1613 g	128,94	1	3834-SET-72-35/83

- 3830-35-C, 3830-40-C, 3830-44-C, 3830-51-C, 3830-57-C, 3830-68-C, 3830-83-C
- 3834-ARBR-9100
- 3834-DRL

Juego de 4 coronas bi metales



**3834-42**

	€		
2025 g	154,40	1	3834-SET-42

- 3830-51-VIP, 3830-76-VIP, 3830-86-VIP, 3830-111-VIP
- 3834-ARBR-9100
- 3834-ES

Juego de 11 coronas bi metales



**3834-53**

	€		
2370 g	224,92	1	3834-SET-53

- 3830-19-VIP, 3830-22-VIP, 3830-25-VIP, 3830-29-VIP, 3830-30-VIP, 3830-35-VIP, 3830-37-VIP, 3830-41-VIP, 3830-52-VIP, 3830-60-VIP, 3830-79-VIP
- 3834-ARBR-930
- 3834-ARBR-9100



Juego de 6 coronas bi-metales



**3834-61**

	€		
3145 g	188,65	1	3834-SET-61

3830-44-VIP, 3830-51-VIP, 3830-57-VIP, 3830-73-VIP, 3830-86-VIP, 3830-114-VIP	
3834-ARBR-9100	

Juego de 6 coronas bi-metales



**3834-62-16/50**

	€		
1065 g	120,55	1	3834-SET-62-16/50

3830-16-VIP, 3830-20-VIP, 3830-25-VIP, 3830-32-VIP, 3830-40-VIP, 3830-50-VIP	
3834-ARBR-9100	
3834-ARBR-930	

Juego de 6 coronas bi-metales



**3834-65-22/64**

	€		
1625 g	156,51	1	3834-SET-65-22/64

3830-22-VIP, 3830-29-VIP, 3830-35-VIP, 3830-44-VIP, 3830-51-VIP, 3830-64-VIP	
3834-ARBR-1130	
3834-ARBR-11152	
3834-DRL	

Juego de 6 coronas bi-metales



**3834-62**

	€		
1050 g	126,13	1	3834-SET-62

3830-19-VIP, 3830-21-VIP, 3830-22-VIP, 3830-29-VIP, 3830-38-VIP, 3830-48-VIP	
3834-ARBR-930	
3834-ARBR-9100	

Juego de 6 coronas bi-metales



**3834-65-16/51**

	€		
1465 g	140,64	1	3834-SET-65-16/51

Un cepillo

3830-16-VIP, 3830-20-VIP, 3830-25-VIP, 3830-32-VIP, 3830-40-VIP, 3830-51-VIP	
3834-ARBR-1130	
3834-ARBR-11152	
3834-DRL	

Juego de 7 coronas bi-metales



**3834-72**

	€		
1080 g	168,14	1	3834-SET-72

3830-19-VIP, 3830-22-VIP, 3830-29-VIP, 3830-35-VIP, 3830-44-VIP, 3830-51-VIP, 3830-64-VIP	
3834-ARBR-930	
3834-ARBR-9100	

Juego de 7 coronas bi-metales



**3834-73**

**g** € 2080 g 209,04 1 3834-SET-73

- 3830-16-VIP, 3830-22-VIP, 3830-51-VIP, 3830-57-VIP, 3830-73-VIP, 3830-76-VIP, 3830-92-VIP
- 3834-ARBR-930
- 3834-ARBR-9100

Juego de 10 coronas bi-metales



**3834-SET-77**

**g** € 3325 g 206,31 1 3834-SET-77

- 3830-16-VIP, 3830-20-VIP, 3830-25-VIP, 3830-32-VIP, 3830-41-VIP, 3830-51-VIP, 3830-73-VIP, 3830-76-VIP, 3830-83-VIP, 3830-86-VIP
- 3834-ARBR-930
- 3834-ARBR-9100
- 3834-DRL

Juego de 8 coronas bi-metales



**3834-86**

**g** € 2540 g 276,86 1 3834-SET-86

- 3830-25-VIP, 3830-32-VIP, 3830-35-VIP, 3830-51-VIP, 3830-54-VIP, 3830-76-VIP, 3830-92-VIP, 3830-114-VIP
- 3834-ARBR-1130
- 3834-ARBR-11152
- 3834-DRLx 2
- 3834-ADP

Juego de 7 coronas bi-metales



**3834-73-22/68**

**g** € 2170 g 155,97 1 3834-SET-73-22/68

- 3830-22-VIP, 3830-29-VIP, 3830-35-VIP, 3830-44-VIP, 3830-51-VIP, 3830-64-VIP, 3830-68-VIP
- 3834-ARBR-1130
- 3834-ARBR-11152
- 3834-DRL

Juego de coronas Sandflex™ bi-metales 25mm-114mm



**3834-SET-84-ES**

**g** € 3600 g 126,29 1 3834-SET-84-ES

- 3830-25-C, 3830-30-C, 3830-35-C, 3830-51-C, 3830-54-C, 3830-76-C, 3830-92-C, 3830-114-C
- 3834-ARBR-930ESM, 3834-ARBR-9100ESM
- 3834-DRL-HSS-ES
- 3834-UPSIZE

Juego de 8 coronas bi-metales



**3834-87**

**g** € 1925 g 193,51 1 3834-SET-87

- 3830-19-VIP, 3830-22-VIP, 3830-29-VIP, 3830-38-VIP, 3830-43-VIP, 3830-48-VIP, 3830-52-VIP, 3830-65-VIP
- 3834-ARBR-930
- 3834-ARBR-9100
- 3834-DRL
- 3834-ES





Juego de 9 coronas bi-metales



**3834-92**

	€		
1440 g	193,52	1	3834-SET-92

- 3830-16-VIP, 3830-22-VIP, 3830-25-VIP, 3830-29-VIP, 3830-32-VIP, 3830-41-VIP, 3830-51-VIP, 3830-73-VIP, 3830-83-VIP
- 3834-ARBR-930
- 3834-ARBR-9100

Juego de 9 coronas bi-metales



**3834-94**

	€		
1815 g	179,46	1	3834-SET-94

- 3830-16-VIP, 3830-19-VIP, 3830-22-VIP, 3830-25-VIP, 3830-30-VIP, 3830-35-VIP, 3830-41-VIP, 3830-51-VIP, 3830-67-VIP
- 3834-ARBR-1130
- 3834-ARBR-11152

Juego de 8 coronas bimetel + soportes



**3834-103**

	€		
2015 g	148,43	1	3834-SET-103

- 3830-16-VIP, 3830-19-VIP, 3830-24-VIP, 3830-29-VIP, 3830-38-VIP, 3830-44-VIP, 3830-57-VIP, 3830-67-VIP
- 3834-ARBR-1130
- 3834-ARBR-11152
- 3834-DRL

Juego de coronas Sandflex™ bi-metales 16mm-83mm



**3834-93**

	€		
2360 g	168,00	1	3834-SET-93

- 3830-16-VIP, 3830-20-VIP, 3830-25-VIP, 3830-32-VIP, 3830-40-VIP, 3830-51-VIP, 3830-67-VIP, 3830-76-VIP, 3830-83-VIP
- 3834-ARBR-930
- 3834-ARBR-9100QC
- 3834-DRL

Juego de 9 coronas bi-metales



**3834-95**

	€		
1350 g	189,74	1	3834-SET-95

- 3830-16-VIP, 3830-19-VIP, 3830-22-VIP, 3830-29-VIP, 3830-35-VIP, 3830-44-VIP, 3830-52-VIP, 3830-57-VIP, 3830-64-VIP
- 3834-ARBR-1130
- 3834-ARBR-11152
- 3834-DRL

Juego de 15 coronas bi-metales



**3834-SET-152**

	€		
3770 g	264,46	1	3834-SET-152

- 3830-16-VIP, 3830-19-VIP, 3830-22-VIP, 3830-25-VIP, 3830-32-VIP, 3830-35-VIP, 3830-44-VIP, 3830-51-VIP, 3830-57-VIP, 3830-60-VIP, 3830-65-VIP, 3830-68-VIP, 3830-73-VIP, 3830-76-VIP, 3830-83-VIP
- 3834-ARBR-930
- 3834-ARBR-9100
- 3834-DRLx 2



Corona multiconstrucción, madera y ladrillo



**3833**

	€		
19 mm	13,62	1	3833-19-C
20 mm	13,45	1	3833-20-C
22 mm	13,59	1	3833-22-C
25 mm	14,02	1	3833-25-C
27 mm	14,63	1	3833-27-C
29 mm	15,46	1	3833-29-C
30 mm	15,27	1	3833-30-C
32 mm	15,57	1	3833-32-C
35 mm	17,48	1	3833-35-C
38 mm	17,48	1	3833-38-C
40 mm	17,79	1	3833-40-C
41 mm	17,79	1	3833-41-C
44 mm	20,92	1	3833-44-C
48 mm	20,92	1	3833-48-C
51 mm	21,43	1	3833-51-C
54 mm	23,22	1	3833-54-C
56 mm	24,18	1	3833-56-C
57 mm	24,18	1	3833-57-C
60 mm	24,18	1	3833-60-C
62 mm	24,18	1	3833-62-C
64 mm	24,32	1	3833-64-C
65 mm	24,32	1	3833-65-C
67 mm	24,32	1	3833-67-C
68 mm	24,58	1	3833-68-C
70 mm	24,77	1	3833-70-C
71 mm	24,77	1	3833-71-C
73 mm	24,77	1	3833-73-C
74 mm	24,77	1	3833-74-C
76 mm	25,69	1	3833-76-C
77 mm	28,20	1	3833-77-C
78 mm	28,20	1	3833-78-C
79 mm	28,20	1	3833-79-C
83 mm	28,75	1	3833-83-C
86 mm	28,95	1	3833-86-C
89 mm	29,09	1	3833-89-C
92 mm	29,92	1	3833-92-C
95 mm	30,78	1	3833-95-C
98 mm	31,30	1	3833-98-C
102 mm	33,06	1	3833-102-C
105 mm	33,37	1	3833-105-C
108 mm	33,52	1	3833-108-C
109 mm	36,50	1	3833-109-C
111 mm	33,76	1	3833-111-C
114 mm	36,59	1	3833-114-C
121 mm	37,04	1	3833-121-C
127 mm	39,05	1	3833-127-C
133 mm	39,98	1	3833-133-C
140 mm	40,62	1	3833-140-C
152 mm	43,68	1	3833-152-C
159 mm	50,07	1	3833-159-C
168 mm	55,98	1	3833-168
177 mm	59,98	1	3833-177
210 mm	69,57	1	3833-210
225 mm	73,11	1	3833-225

-C: En clip

Juego de coronas multiconstrucción Superior™ de 32-83 mm - 6 Piezas



**3833-PROMO-42**

g	€		
1489 g	140,12	1	3833-PROMO-42

3833-32-C, 3833-51-C, 3833-76-C, 3833-83-C	
3834-ARBR-9100EL	
3834-UPSIZE	

Juego de coronas multiconstrucción Superior™ de 19-64 mm - 10 piezas



**3833-SET-101**

kg	€		
2.75 kg	320,87	1	3833-SET-101

3833-19-C, 3833-22-C, 3833-29-C, 3833-35-C, 3833-44-C, 3833-51-C, 3833-64-C	
3834-ARBR-930EL, 3834-ARBR-9100EL	
3834-DRL-EL	

Juego de coronas multiconstrucción Superior™, 19 mm-86 mm - 14 unidades



**3833-SET-201**

kg	€		
4.35 kg	364,48	1	3833-SET-201

3833-19-C, 3833-20-C, 3833-25-C, 3833-32-C, 3833-41-C, 3833-51-C, 3833-73-C, 3833-76-C, 3833-83-C, 3833-86-C	
3834-ARBR-930EL, 3834-ARBR-9100EL	
3834-DRL-EL	
3834-UPSIZE	

Juego de coronas multiconstrucción Superior™ de 19-83 mm - 14 piezas



**3833-SET-202**

kg	€		
4.1 kg	359,39	1	3833-SET-202

3833-19-C, 3833-20-C, 3833-25-C, 3833-32-C, 3833-41-C, 3833-51-C, 3833-57-C, 3833-60-C, 3833-73-C, 3833-83-C	
3834-ARBR-930EL, 3834-ARBR-9100EL	
3834-DRL-EL	
3834-UPSIZE	



Juego de coronas multiconstrucción Superior™ de 19-78 mm - 14 piezas



**3833-SET-203**

kg € 1 3833-SET-203

4.65 kg 359,39

3833-19-C, 3833-22-C, 3833-54-C, 3833-56-C,  
3833-57-C, 3833-62-C, 3833-68-C, 3833-71-C,  
3833-74-C, 3833-78-C

3834-ARBR-930EL, 3834-ARBR-9100EL

3834-DRL-EL

3834-UPSIZE

Juego de coronas multiconstrucción Superior™ de 22-67 mm - 9 piezas



**3833-SET-205**

kg € 1 3833-SET-205

2.81 kg 271,36

3833-22-C, 3833-35-C, 3833-44-C, 3833-51-C,  
3833-67-C

3834-ARBR-930EL, 3834-ARBR-9100EL

3834-DRL-EL

3834-UPSIZE

Juego de coronas multiconstrucción Superior™ de 19-76 mm - 15 piezas



**3833-SET-208**

kg € 1 3833-SET-208

3.72 kg 371,34

3833-19-C, 3833-22-C, 3833-25-C, 3833-32-C,  
3833-35-C, 3833-38-C, 3833-44-C, 3833-51-C,  
3833-57-C, 3833-68-C, 3833-76-C

3834-ARBR-930EL, 3834-ARBR-9100EL

3834-DRL-EL

3834-UPSIZE

Juego de coronas multiconstrucción Superior™ de 32-86 mm - 10 piezas



**3833-SET-204**

kg € 1 3833-SET-204

3.88 kg 323,87

3833-32-C, 3833-41-C, 3833-51-C, 3833-73-C,  
3833-76-C, 3833-83-C, 3833-86-C

3834-ARBR-9100EL

3834-DRL-EL

3834-UPSIZE

Juego de coronas multiconstrucción Superior™, 19 mm-83 mm - 14 unidades



**3833-SET-207**

kg € 1 3833-SET-207

3.90 kg 363,88

3833-19-C, 3833-22-C, 3833-25-C, 3833-35-C,  
3833-44-C, 3833-51-C, 3833-64-C, 3833-67-C,  
3833-76-C, 3833-83-C

3834-ARBR-930EL, 3834-ARBR-9100EL

3834-DRL-EL

3834-UPSIZE

Juego de coronas multiconstrucción Superior™, 25 mm-114 mm - 12 unidades



**3833-SET-301**

kg € 1 3833-SET-301

4.38 kg 344,22

3833-25-C, 3833-32-C, 3833-35-C, 3833-51-C,  
3833-54-C, 3833-76-C, 3833-92-C, 3833-114-C

3834-ARBR-930EL, 3834-ARBR-9100EL

3834-DRL-EL

3834-UPSIZE

Juego de coronas multiconstrucción Superior™ de 51-111 mm - 7 piezas



**3833-SET-302**

kg	€		
3.51 kg	224,94	1	3833-SET-302

3833-51-C, 3833-76-C, 3833-86-C, 3833-111-C	
3834-ARBR-9100EL	
3834-DRL-EL	
3834-UPSIZE	

Juego de coronas multiconstrucción Superior™ de 35-114 mm - 11 piezas



**3833-SET-303**

kg	€		
4.17 kg	288,84	1	3833-SET-303

3833-35-C, 3833-40-C, 3833-51-C, 3833-57-C, 3833-60-C, 3833-74-C, 3833-83-C, 3833-105-C	
3834-ARBR-9100EL	
3834-DRL-EL	
3834-UPSIZE	

Juego de coronas multiconstrucción Superior™, 19 mm-114 mm - 13 unidades



**3833-SET-304**

kg	€		
4.20 kg	357,64	1	3833-SET-304

3833-19-C, 3833-25-C, 3833-32-C, 3833-35-C, 3833-51-C, 3833-54-C, 3833-76-C, 3833-92-C, 3833-114-C	
3834-ARBR-930EL, 3834-ARBR-9100EL	
3834-DRL-EL	
3834-UPSIZE	

Coronas con puntas de carburo para acero inoxidable, 16-127 mm



**3832**

	€		
14 mm	20,60	6	3832-14
16 mm	20,60	6	3832-16
17 mm	20,60	6	3832-17
19 mm	20,60	6	3832-19
20 mm	20,60	6	3832-20
21 mm	20,60	6	3832-21
22 mm	20,60	6	3832-22
24 mm	20,60	6	3832-24
25 mm	21,72	6	3832-25
27 mm	23,22	6	3832-27
29 mm	23,22	6	3832-29
30 mm	23,22	6	3832-30
32 mm	23,22	6	3832-32
33 mm	23,22	6	3832-33

	€		
35 mm	25,83	6	3832-35
37 mm	25,83	6	3832-37
38 mm	25,83	6	3832-38
40 mm	25,83	6	3832-40
41 mm	25,83	6	3832-41
43 mm	25,83	6	3832-43
44 mm	29,96	6	3832-44
46 mm	29,96	6	3832-46
48 mm	29,96	6	3832-48
51 mm	29,96	6	3832-51
52 mm	36,34	4	3832-52
54 mm	36,34	4	3832-54
56 mm	36,34	4	3832-56
57 mm	36,34	4	3832-57
59 mm	36,34	4	3832-59
60 mm	36,34	4	3832-60
64 mm	40,07	4	3832-64
65 mm	40,07	4	3832-65
67 mm	40,07	4	3832-67
68 mm	40,07	4	3832-68
70 mm	40,07	4	3832-70
73 mm	40,07	4	3832-73
76 mm	44,58	4	3832-76
79 mm	44,58	4	3832-79
83 mm	44,58	4	3832-83
86 mm	44,58	4	3832-86
89 mm	44,58	4	3832-89
92 mm	51,68	4	3832-92
95 mm	56,56	4	3832-95
98 mm	59,93	4	3832-98
102 mm	62,90	4	3832-102
105 mm	67,39	4	3832-105
108 mm	79,02	4	3832-108
111 mm	91,39	4	3832-111
114 mm	101,50	4	3832-114
121 mm	112,74	1	3832-121
127 mm	123,98	1	3832-127
133 mm	134,47	1	3832-133
140 mm	145,70	1	3832-140
146 mm	153,17	1	3832-146
152 mm	166,65	1	3832-152
16 mm	20,60	1	3832-16-C
19 mm	20,60	1	3832-19-C
20 mm	20,60	1	3832-20-C
22 mm	20,60	1	3832-22-C
24 mm	20,60	1	3832-24-C
25 mm	21,73	1	3832-25-C
29 mm	23,22	1	3832-29-C
30 mm	23,22	1	3832-30-C
32 mm	23,22	1	3832-32-C
35 mm	25,83	1	3832-35-C
38 mm	25,83	1	3832-38-C
41 mm	25,83	1	3832-41-C
44 mm	29,96	1	3832-44-C
46 mm	29,96	1	3832-46-C
48 mm	29,96	1	3832-48-C
51 mm	29,96	1	3832-51-C
54 mm	36,34	1	3832-54-C
57 mm	36,34	1	3832-57-C
60 mm	36,34	1	3832-60-C
64 mm	40,08	1	3832-64-C
73 mm	40,08	1	3832-73-C
76 mm	44,58	1	3832-76-C
83 mm	44,58	1	3832-83-C
86 mm	44,58	1	3832-86-C
92 mm	51,68	1	3832-92-C
102 mm	73,69	1	3832-102-C
114 mm	118,87	1	3832-114-C
127 mm	131,62	1	3832-127-C

-C: En clip





Coronas con puntas de carburo para acero inoxidable 25mm - 114mm - 12 piezas



### 3832-SET-84-ES

	€		
3600 g	238,70	1	3832-SET-84-ES

- 3832-25-C, 3832-30-C, 3832-35-C, 3832-51-C, 3832-54-C, 3832-76-C, 3832-92-C, 3832-114-C
- 3834-ARBR-9100ESM, 3834-ARBR-930ESM
- 3834-DRL-HSS-ES
- 3834-UPSIZ

Juegos de coronas con puntas de carburo para acero inoxidable, 16 mm-114 mm, 20 piezas



### 3832-SET-164-ES

	€		
4800 g	394,87	1	3832-SET-164-ES

- 3832-16-C, 3832-20-C, 3832-25-C, 3832-32-C, 3832-35-C, 3832-41-C, 3832-44-C, 3832-46-C, 3832-51-C, 3832-54-C, 3832-73-C, 3832-76-C, 3832-83-C, 3832-86-C, 3832-92-C, 3832-114-C
- 3834-ARBR-9100ESM, 3834-ARBR-930ESM
- 3834-DRL-HSS-ES
- 3834-UPSIZ

Juego de coronas mixto 35mm-114mm



### 3835-SET-64

		€		
10	3870 g	260,51	1	3835-SET-64

- 3830-35-C, 3830-73-C
- 3833-35-C, 3833-73-C, 3833-76-C, 3833-114-C
- 3834-ARBR-9100QC-C
- 3834-ARBR-9100EL
- 3834-DRL-EL
- 3834-DRL

Juego de coronas mixto 12mm-86mm



### 3835-SET-711

		€		
18	3680 g	273,52	1	3835-SET-711

- 3830-35-C, 3830-41-C, 3830-51-C, 3830-73-C, 3830-76-C, 3830-83-C, 3830-86-C
- 9629-12, 9629-14, 9629-16, 9629-18, 9629-20, 9629-22, 9629-25, 9629-28, 9629-32
- 3834-ARBR-9100ESM
- 3834-DRL-HSS-ES

Soporte para coronas con función eyectora



### 3834-ARBR-EL/ES

		€		
19-30 mm	8,5 mm	43,12	1	3834-ARBR-930EL
32-159 mm	8,5 mm	43,87	1	3834-ARBR-9100EL
16-30 mm	8,5 mm	42,50	1	3834-ARBR-930ESM
32-152 mm	8,5 mm	44,55	1	3834-ARBR-9100ESM

ES: Bimetal y metal duro (Diam. 14-30/Diam 32-210mm) EL: Metal duro (Diam19-30/Diam 32-159)

Broca piloto con punta de carburo para soportes 930EL y 9100EL



### 3834-DRL-EL

		€		
6.35 mm	202 mm	9,68	1	3834-DRL-EL

para soportes 930EL y 9100EL

Accesorios de coronas, broca piloto con eyector corto



### 3834-DRL-HSS-ES

		€		
6.35 mm	138 mm	9,28	1	3834-DRL-ES
6.35 mm	138 mm	16,36	1	3834-DRL-HSS-ES

### Aumentador para agujeros



#### 3834-upsize

Diagram	€	Icons	Part No.
	4,56		3834-UPSIZ

20.5 mm

### Soporte de corona



#### 3834-ARBR

Diagram	Diagram	€	Icons	Part No.
		12,16		3834-ARBR-630
14-30 mm	6.4 mm	12,76		3834-ARBR-630-C
14-30 mm	6.4 mm	9,72		3834-ARBR-730
14-30 mm	6.4 mm	10,23		3834-ARBR-730-C
14-30 mm	8.5 mm	12,16		3834-ARBR-930
14-30 mm	8.5 mm	12,76		3834-ARBR-930-C
14-30 mm	11.1 mm	14,04		3834-ARBR-1130
14-30 mm	11.1 mm	14,74		3834-ARBR-1130-C

SDS+

### Soporte para coronas, cambio rápido



#### 3834-ARBR-QC

Diagram	Diagram	€	Icons	Part No.
		15,55		3834-ARBR-930QC-C
14-30 mm	8.5 mm	25,47		3834-ARBR-9100
32-152 mm	8.5 mm	26,76		3834-ARBR-9100-C
32-152 mm	8.5 mm	21,72		3834-ARBR-9100QC
32-152 mm	8.5 mm	23,05		3834-ARBR-9100QC-C
32-210 mm	11.1 mm	25,47		3834-ARBR-11152
32-210 mm	11.1 mm	26,76		3834-ARBR-11152-C
32-210 mm	11.1 mm	21,72		3834-ARBR-11152QC
32-210 mm	11.1 mm	22,82		3834-ARBR-11152QC-C
32-210 mm	15.4 mm	25,47		3834-ARBR-16152
32-210 mm	15.4 mm	23,80		3834-ARBR-16152QC

-C: con clip para colgar

### Soporte de corona SDS+



#### 3834-ARBR-SD

Diagram	Diagram	€	Icons	Part No.
		14,98		3834-ARBR-SD30
14-30 mm	SDS+ mm	26,98		3834-ARBR-SD152QC
32-210 mm	SDS+ mm			

### Broca piloto



#### 3834-DRL

Diagram	Diagram	€	Icons	Part No.
		5,82		3834-DRL
6.35 mm	81 mm			

### Accesorios para coronas, broca piloto de carburo STD



#### 3834-DRL-CT/L

Diagram	Diagram	€	Icons	Part No.
		16,87		3834-DRL-CT
6.35 mm	81 mm	9,41		3834-DRL-L
6.35 mm	114 mm			

### Prolongador



#### 3834-EXT

Diagram	Diagram	€	Icons	Part No.
		21,42		3834-EXT-1
11.1 mm	330 mm	21,42		3834-EXT-2
8.5 mm	330 mm			

### Muelle expulsor



#### 3834-ES

Diagram	€	Icons	Part No.
	2,20		3834-ES
10 g			

### Adaptador para soporte



#### 3834-ADP

Diagram	€	Icons	Part No.
	6,61		3834-ADP
20 g			





Tornillos de repuesto para soportes de corona



### 3834-SCREWS

g	€		
9 g	2,75	1	3834-M6X29-SET
9 g	1,72	1	3834-M8X5-SET
9 g	1,82	1	3834-M8X6-SET
9 g	1,94	1	3834-M8X10-SET

Hoja de sable para metal duro



### 3940-HM

		€		
150 mm	8/12	7,29	10	3940-150-8/12-ST-2P
150 mm	8/12	18,23	5	3940-150-8/12-ST-5P
150 mm	8/12	34,74	1	3940-150-8/12-ST-10P
150 mm	8/12	329,59	1	3940-150-8/12-ST-100P
228 mm	8/12	9,46	5	3940-228-8/12-ST-2P
228 mm	8/12	23,64	5	3940-228-8/12-ST-5P
228 mm	8/12	44,62	1	3940-228-8/12-ST-10P
228 mm	8/12	424,98	1	3940-228-8/12-ST-100P
150 mm	10	8,25	10	3940-150-10-HST-2P
150 mm	10	20,64	5	3940-150-10-HST-5P
150 mm	10	37,39	1	3940-150-10-HST-10P
150 mm	10	329,59	1	3940-150-10-ST-100P
150 mm	10	7,29	5	3940-150-10-ST-2P
150 mm	10	18,23	5	3940-150-10-ST-5P
150 mm	10	34,74	1	3940-150-10-ST-10P
150 mm	14	8,37	10	3940-150-14-HST-2P
150 mm	14	20,94	5	3940-150-14-HST-5P
150 mm	14	37,80	1	3940-150-14-HST-10P
150 mm	18	8,37	10	3940-150-18-HST-2P
150 mm	18	20,94	5	3940-150-18-HST-5P
150 mm	18	37,80	1	3940-150-18-HST-10P
228 mm	10	9,46	10	3940-228-10-HST-2P
228 mm	10	25,73	5	3940-228-10-HST-5P
228 mm	10	47,42	1	3940-228-10-HST-10P
228 mm	10	644,25	1	3940-228-10-HST-100P
228 mm	10	13,16	10	3940-228-10-ST-2P
228 mm	10	23,64	5	3940-228-10-ST-5P
228 mm	10	44,62	1	3940-228-10-ST-10P
228 mm	10	424,98	1	3940-228-10-ST-100P
228 mm	14	10,54	10	3940-228-14-HST-2P
228 mm	14	26,37	5	3940-228-14-HST-5P
228 mm	14	48,43	1	3940-228-14-HST-10P
228 mm	18	10,38	10	3940-228-18-HST-2P
228 mm	18	25,95	5	3940-228-18-HST-5P
228 mm	18	51,91	1	3940-228-18-HST-10P
300 mm	10	12,49	10	3940-300-10-HST-2P
300 mm	10	31,26	5	3940-300-10-HST-5P
300 mm	10	55,66	1	3940-300-10-HST-10P
300 mm	14	12,55	10	3940-300-14-HST-2P
300 mm	14	31,34	5	3940-300-14-HST-5P
300 mm	14	55,66	1	3940-300-14-HST-10P
300 mm	18	12,33	10	3940-300-18-HST-2P
300 mm	18	30,86	5	3940-300-18-HST-5P
300 mm	18	54,55	1	3940-300-18-HST-10P

Hojas de sable para metal fino



### 3940-FM

		€		
100 mm	24	5,55	10	3940-100-24-ST-2P
100 mm	24	13,86	5	3940-100-24-ST-5P
100 mm	24	26,50	1	3940-100-24-ST-10P
150 mm	24	7,29	5	3940-150-24-ST-2P
150 mm	24	18,23	5	3940-150-24-ST-5P
150 mm	24	34,74	1	3940-150-24-ST-10P
150 mm	24	329,59	1	3940-150-24-ST-100P

## HOJAS DE SABLE

Hoja de sable bi-metal



### 3940-M

		€		
100 mm	14	5,55	10	3940-100-14-ST-2P
100 mm	14	13,86	5	3940-100-14-ST-5P
100 mm	14	26,50	1	3940-100-14-ST-10P
100 mm	18	5,55	10	3940-100-18-ST-2P
100 mm	18	13,86	5	3940-100-18-ST-5P
100 mm	18	26,50	1	3940-100-18-ST-10P
150 mm	14	7,29	10	3940-150-14-ST-2P
150 mm	14	18,23	5	3940-150-14-ST-5P
150 mm	14	34,74	1	3940-150-14-ST-10P
150 mm	14	329,59	1	3940-150-14-ST-100P
150 mm	18	7,29	10	3940-150-18-ST-2P
150 mm	18	18,23	5	3940-150-18-ST-5P
150 mm	18	34,74	1	3940-150-18-ST-10P
150 mm	18	329,59	1	3940-150-18-ST-100P
228 mm	14	9,46	10	3940-228-14-ST-2P
228 mm	14	23,64	5	3940-228-14-ST-5P
228 mm	14	44,62	1	3940-228-14-ST-10P
228 mm	14	424,98	1	3940-228-14-ST-100P
228 mm	18	9,46	10	3940-228-18-ST-2P
228 mm	18	23,64	5	3940-228-18-ST-5P
228 mm	18	44,62	1	3940-228-18-ST-10P
228 mm	18	424,98	1	3940-228-18-ST-100P
300 mm	14	11,65	10	3940-300-14-ST-2P
300 mm	14	29,14	5	3940-300-14-ST-5P
300 mm	14	55,63	1	3940-300-14-ST-10P
300 mm	14	528,83	1	3940-300-14-ST-100P
300 mm	18	11,65	10	3940-300-18-ST-2P
300 mm	18	29,14	5	3940-300-18-ST-5P
300 mm	18	55,63	1	3940-300-18-ST-10P
300 mm	18	527,78	1	3940-300-18-ST-100P

Hoja de sable bi-metal de precisión



### 3940-PM

		€		
100 mm	14	5,55	10	3940-100-14-SC-2P
100 mm	14	13,86	5	3940-100-14-SC-5P
100 mm	18	5,55	10	3940-100-18-SC-2P
100 mm	18	13,86	5	3940-100-18-SC-5P
100 mm	24	5,55	10	3940-100-24-SC-2P
100 mm	24	13,86	5	3940-100-24-SC-5P

Hojas de sable con puntas de carburo de tungsteno para materiales de industria pesada



### 3946-C\_HM

		€		
150 mm	8	22,92	10	3946-150-8-HST-1P
228 mm	8	31,73	10	3946-228-8-HST-1P
300 mm	8	41,01	10	3946-300-8-HST-1P

10P = 10 piezas

Hojas de sable con puntas de carburo de tungsteno para acero inoxidable



### 3946-C\_SS

Longitud	Tipos de dientes	€	Pack	Modelo
150 mm	10	9,40	10	3946-150-10-HST-1P
228 mm	10	36,44	10	3946-228-10-HST-1P
300 mm	10	49,36	10	3946-300-10-HST-1P

Hojas de sable de grano de diamante para hierro fundido y cerámica



### 3946-D\_CI

Longitud	Tipos de dientes	€	Pack	Modelo
100 mm	Grit	9,40	10	3946-100-DG-ST-2P
150 mm	Grit	16,45	10	3946-150-DG-ST-2P

Hoja de sierra para talleres de automoción



### 3845

Longitud	Tipos de dientes	€	Pack	Modelo
91.5 mm	18	41,83	1	3845-18-10P
91.5 mm	24	41,83	1	3845-24-10P
90 mm	32	41,83	1	3845-32-10P

Hoja de sierra bi-metal, para madera y metal



### 3940-WM

Longitud	Tipos de dientes	€	Pack	Modelo
150 mm	4/6	9,55	10	3940-150-4/6-SC-2P
150 mm	4/6	18,23	5	3940-150-4/6-SC-5P
150 mm	4/6	34,74	1	3940-150-4/6-SC-10P

Longitud	Tipos de dientes	€	Pack	Modelo
150 mm	5/8	9,55	10	3940-150-5/8-SL-2P
150 mm	5/8	18,23	5	3940-150-5/8-SL-5P
150 mm	5/8	34,74	1	3940-150-5/8-SL-10P
150 mm	5/8	329,59	1	3940-150-5/8-SL-100P
150 mm	6	9,55	10	3940-150-6-ST-2P
150 mm	6	18,23	5	3940-150-6-ST-5P
150 mm	6	34,74	1	3940-150-6-ST-10P
228 mm	6	11,05	10	3940-228-6-SL-2P
228 mm	6	23,64	5	3940-228-6-SL-5P
228 mm	6	44,62	1	3940-228-6-SL-10P
300 mm	6	11,05	10	3940-300-6-SL-2P
300 mm	6	29,14	5	3940-300-6-SL-5P
300 mm	6	55,63	1	3940-300-6-SL-10P
300 mm	8/12	11,05	5	3940-300-8/12-SL-2P
300 mm	8/12	29,14	5	3940-300-8/12-SL-5P
300 mm	8/12	55,63	1	3940-300-8/12-SL-10P
300 mm	8/12	517,19	1	3940-300-8/12-SL-100P

Hoja de sable bi-metal, para "fuego y rescate"



### 3940-FR

Longitud	Tipos de dientes	€	Pack	Modelo
228 mm	10	13,93	10	3940-228-10-DSL-2P
228 mm	10	34,79	5	3940-228-10-DSL-5P
228 mm	10	62,77	1	3940-228-10-DSL-10P
228 mm	10	627,76	1	3940-228-10-DSL-100P

Hoja de sable bi-metal para demolición



### 3940-D

Longitud	Tipos de dientes	€	Pack	Modelo
150 mm	5/8	11,05	5	3940-150-5/8-DSL-2P
150 mm	5/8	19,10	5	3940-150-5/8-DSL-5P
150 mm	5/8	36,36	1	3940-150-5/8-DSL-10P
228 mm	5/8	11,05	10	3940-228-5/8-DSL-2P
228 mm	5/8	24,59	5	3940-228-5/8-DSL-5P
228 mm	5/8	47,05	1	3940-228-5/8-DSL-10P
300 mm	5/8	12,27	10	3940-300-5/8-DSL-2P
300 mm	5/8	30,62	5	3940-300-5/8-DSL-5P
300 mm	5/8	58,39	1	3940-300-5/8-DSL-10P

Hoja de sable bi-metal, para reparación de pallets



### 3940-PR

Longitud	Tipos de dientes	€	Pack	Modelo
228 mm	10/14	44,19	1	3940-228-10/14-PR13-10P
228 mm	10/14	32,13	1	3940-228-10/14-PR09-10P
228 mm	10/14	321,12	1	3940-228-10/14-PR09-100P
228 mm	10/14	441,93	1	3940-228-10/14-PR13-100P
228 mm	8/12	408,57	1	3940-228-8/12-PR13-100P
228 mm	10	426,72	1	3940-228-10-PR09-100P

Hojas de sable con puntas de carburo de tungsteno para madera y clavos



### 3946-C\_WM

Longitud	Tipos de dientes	€	Pack	Modelo
150 mm	6	9,40	10	3946-150-6-DSL-1P
228 mm	6	29,09	10	3946-228-6-DSL-1P
300 mm	6	32,91	10	3946-300-6-DSL-1P

Hoja de sable, para madera HCS



### 3942-W

Longitud	Tipos de dientes	€	Pack	Modelo
228 mm	7	12,41	10	3942-228-7-HSL-2P
228 mm	7	24,16	5	3942-228-7-HSL-5P
228 mm	7	44,62	1	3942-228-7-HSL-10P
300 mm	7	20,78	10	3942-300-7-HSL-2P
300 mm	7	27,44	5	3942-300-7-HSL-5P
300 mm	7	51,10	1	3942-300-7-HSL-10P



Hoja de sable HCS para madera gruesa



### 3942-CW

Longitud	Teeth	€	Paquetes	Modelo
228 mm	5	12,63	10	3942-228-5-HSL-2P
228 mm	5	25,75	5	3942-228-5-HSL-5P
228 mm	5	47,43	1	3942-228-5-HSL-10P
300 mm	5	15,72	10	3942-300-5-HSL-2P
300 mm	5	30,60	5	3942-300-5-HSL-5P
300 mm	5	53,28	1	3942-300-5-HSL-10P

Hoja de sable curva para corte fino



### 3943-C30-JT-F

Longitud	Teeth	€	Paquetes	Modelo
323 mm	13 in	19,69	10	3943-C30-JT-F

Hoja de sable recta corte fino



### 3943-S20-JT-F

Longitud	Teeth	€	Paquetes	Modelo
228 mm	9 in	16,22	10	3943-S20-JT-F

Hojas de sable HSC para madera y plástico



### 3942-WP

Longitud	Teeth	€	Paquetes	Modelo
228 mm	11	9,00	10	3942-228-11-HSL-2P
228 mm	11	18,99	5	3942-228-11-HSL-5P
228 mm	11	31,77	1	3942-228-11-HSL-10P

Hoja de sable curva para corte medio



### 3943-C30-JT-M

Longitud	Teeth	€	Paquetes	Modelo
323 mm	13 in	19,69	10	3943-C30-JT-M
373 mm	15 in	22,01	10	3943-C35-JT-M

Hoja de sable recta para corte grueso



### 3943-R28-UT-C-2P

Longitud	Teeth	€	Paquetes	Modelo
300 mm	12 in	17,38	10	3943-R28-UT-C-2P

Hoja de sable bi-metal, para yeso y planchas



### 3942-PB

Longitud	Teeth	€	Paquetes	Modelo
150 mm	7	19,82	10	3942-150-7-SL-2P
150 mm	7	19,82	5	3942-150-7-SL-5P
150 mm	7	36,87	1	3942-150-7-SL-10P
228 mm	7	9,59	10	3942-228-7-SL-2P
228 mm	7	23,97	5	3942-228-7-SL-5P
228 mm	7	44,83	1	3942-228-7-SL-10P
300 mm	7	14,98	10	3942-300-7-SL-2P
300 mm	7	28,78	5	3942-300-7-SL-5P
300 mm	7	49,65	1	3942-300-7-SL-10P

Hoja de sable curva corte grueso



### 3943-C35-JT-C

Longitud	Teeth	€	Paquetes	Modelo
373 mm	15 in	21,32	10	3943-C35-JT-C

Juego de 5 hojas de sierra, para metal



### 3940-METAL-SET-5P

Cantidad	Peso	€	Paquetes	Modelo
5	125 g	22,66	5	3940-METAL-SET-5P

3940-150-14-ST, 3940-150-18-ST, 3940-150-24-ST, 3940-228-18-ST, 3940-228-14-ST, 3940-150-14-ST, 3940-150-18-ST, 3940-150-24-ST, 3940-228-18-ST, 3940-228-14-ST

Juego de hojas de sable bimetálicas Sandflex® para metales (12 piezas)



### 3940-METAL-SET-12P

		€		
12	460 g	54,38	6	3940-METAL-SET-12P

Juego de 5 hojas de sable, metal duro y demolición



### 3940-HDD-SET-5P

		€		
5	222 g	34,53	5	3940-HDD-SET-5P

3940-150-5/8-DSL, 3940-228-5/8-DSL, 3940-228-10-DSL, 3940-150-14-HST, 3940-228-14-HST, 3940-150-5/8-DSL, 3940-228-5/8-DSL, 3940-228-10-DSL, 3940-150-14-HST, 3940-228-14-HST

Juego de hojas de sable, para metal y madera



### 3940-MIX-SET-5P

		€		
5	150 g	25,88	5	3940-MIX-SET-5P

3940-100-24-SC, 3940-150-18-ST, 3940-150-14-ST, 3940-228-6-SL, 3942-228-7-HSL, 3940-100-24-SC, 3940-150-18-ST, 3940-150-14-ST, 3940-228-6-SL, 3942-228-7-HSL

Juego de 10 hojas de sierra, para metal y madera



### 3940-MIX-SET-10P

		€		
10	245 g	46,39	4	3940-MIX-SET-10P

3940-100-24-SC, 3940-100-18-SC, 3940-150-24-ST, 3940-150-18-ST, 3940-150-14-ST, 3940-150-10-ST, 3940-228-6-SL, 3942-228-11-HSL, 3942-228-7-HSL, 3942-150-7-SL

Juego de hojas de sable para madera y metal (12 piezas)



### 3940-MIX-SET-12P

		€		
12	480 g	55,66	6	3940-MIX-SET-12P

Juego de 5 hojas de sable, para madera



### 3942-WOOD-SET-5P

		€		
5	191 g	30,21	5	3942-WOOD-SET-5P

3942-228-6-SL, 3942-228-11-HSL, 2x 3942-228-7-HSL, 3942-150-7-SL, 3940-228-6-SL, 3942-228-11-HSL, 3942-228-7-HSL, 3942-228-7-HSL, 3942-150-7-SL

Juego de hojas de sable para madera (12 piezas)



### 3942-WOOD-SET-12P

		€		
12	525 g	72,51	6	3942-WOOD-SET-12P

Hoja de acero inoxidable para corte de carne y hielo



### 3944

		€		
300 mm	4	11,77	10	3944-300-3-MEAT-1P

Hojas de sable con punta de carburo para materiales de piedra



### 3946-CT

		€		
150 mm	6	25,24	5	3946-150-6-SL-1P
228 mm	3	24,59	5	3946-228-3-ST-1P

Hojas de sable con dientes de carburo de tungsteno para ladrillos, arlita y hormigón celular.



### 3946-C B

		€		
300 mm	2	35,26	10	3946-300-2-CB-1P
457 mm	2	47,01	10	3946-457-2-CB-1P





## HOJAS DE CALAR

Anclaje europeo, acero al carbono



### 91-M

L	T	€	X	F
100 mm	15/23	8,76	1	91-3PM-5P
100 mm	8	13,42	1	91-433-5P
77 mm	36	7,43	1	91-502-5P
77 mm	21	9,11	1	91-512-5P
77 mm	21	36,18	1	91-512-25P
77 mm	21	8,19	1	91-517-5P
77 mm	13	7,68	1	91-522-5P
132 mm	25	9,90	1	91-611-5P
77 mm	21	8,00	1	91-612-5P
77 mm	13	9,29	1	91-622-5P
132 mm	14	17,03	1	91-7V1-5P

Anclaje europeo, acero al carbono



### 91-WM

L	T	€	X	F
132 mm	10/14	13,70	1	91-4PWM-5P
100 mm	10/14	13,93	1	91-623-5P

Anclaje europeo, acero al carbono



### 91-W

L	T	€	X	F
117 mm	10	10,83	1	91-2PW-5P
132 mm	8	18,41	1	91-434-5P
105 mm	6	19,67	1	91-444-5P
100 mm	8	4,54	1	91-023-5P
77 mm	12	5,96	1	91-027-5P
100 mm	6	6,28	1	91-143-5P
100 mm	6	28,69	1	91-143-25P
100 mm	6	114,87	1	91-143-100P
100 mm	6	7,36	1	91-148-5P
100 mm	10	6,61	1	91-223-5P
100 mm	10	9,26	1	91-226-5P
132 mm	6	8,94	1	91-233-5P
100 mm	6	7,43	1	91-243-5P
77 mm	19	13,93	1	91-412-5P
100 mm	6	19,23	1	91-443-5P

Juego de 10 hojas de calar para metal



### 91-METAL-10P

X	€	F
10	19,38	1 91-METAL-10P

x3 91-512 (T118A), x3 91-522 (T118B), x1 91-433 (T127DF), x1 91-502 (T118G), x2 91-4PWM (T111HF)

Juego de 10 hojas de calar para madera



### 91-WOOD-10P

X	€	F
10	16,91	1 91-WOOD-10P

x4 91-143 (T144D), x2 91-223 (T101B), x2 91-023 (T111C), x1 91-148 (T244D), x1 91-226 (T101BR)

Juego mixto de 10 hojas de calar



### 91-MIXED-10P

X	€	F
10	18,56	1 91-MIXED-10P

x3 91-143 (T144D), x1 91-223 (T101B), x1 91-148 (T244D), x2 91-512 (T118A), x2 91-522 (T118B), x1 91-623 (T111HF)

## ACCESORIOS MULTIHERRAMIENTAS

Hojas multi herramientas con forma estándar para cortar madera



### 92-S W

X	L	T	€	F
1	35 x 50 x 97 mm	18,81	70	92-133-1P
3	35 x 50 x 97 mm	49,36	46	92-133-3P
25	35 x 50 x 97 mm	386,25	1	92-133-25P

Hojas multi herramientas con forma estándar para cortes de precisión en madera



### 92-P W

X	L	T	€	F
1	30 x 50 x 97 mm	21,16	70	92-205-1P
3	30 x 50 x 97 mm	60,29	46	92-205-3P
1	65 x 50 x 97 mm	17,63	70	92-229-1P
25	30 x 50 x 97 mm	528,86	1	92-205-25P

Hojas multiherramientas con forma estándar curvada para cortar madera



### 92-C W

X	L	T	€	F
1	65 x 50 x 97 mm	15,86	70	92-225-1P
25	65 x 50 x 97 mm	309,00	1	92-225-25P



Hoja multi herramientas con forma estándar para cortes universales en madera con clavos



### 92-U\_WN

			€		
1		35 x 50 x 97 mm	17,63	70	92-160-1P
3		35 x 50 x 97 mm	54,06	46	92-160-3P
25		35 x 50 x 97 mm	375,95	1	92-160-25P

Cuchilla Multi-herramientas Starlock Plus para Corte Universal de Madera con Metal



### 92-PU\_WM

			€		
25		28 x 60 x 107 mm	401,70	1	92-151-25P
25		44 x 60 x 107 mm	432,60	1	92-152-25P

Hojas multi herramientas en segmentos para cortar metal



### 92-M\_S

			€		
1		85 mm	26,93	90	92-106-1P

Hoja multiherramientas duradera con forma estándar para cortar madera con clavos



### 92-LF\_WN

			€		
1		50 x 50 x 97 mm	18,81	70	92-221-1P
1		65 x 50 x 97 mm	17,63	70	92-228-1P
25		65 x 50 x 97 mm	309,00	1	92-228-25P

Hoja multiherramientas con puntas de carburo y revestimiento de TiN para cortar metales



### 92-C\_M

			€		
25		35 x 42 x 82 mm	690,10	1	92-236-25P
1		35 x 42 x 82 mm	30,56	70	92-236-1P

Hojas multi herramientas en segmentos para cortar madera



### 92-SP

			€		
1		85 mm	24,32	90	92-113-1P

Cuchilla multi herramientas con forma estándar para cortar madera con metal



### 92-U\_WM

			€		
1		28 x 55 x 100 mm	19,39	70	92-222-1P
3		28 x 55 x 100 mm	55,27	46	92-222-3P
25		28 x 55 x 100 mm	375,95	1	92-222-25P
1		44 x 55 x 100 mm	19,98	70	92-223-1P
3		44 x 55 x 100 mm	53,47	46	92-223-3P
25		44 x 55 x 100 mm	412,00	1	92-223-25P

Hojas multiherramientas con forma estándar para corte fino en metal



### 92-FM

			€		
1		30 x 50 x 97 mm	15,29	70	92-157-1P
25		35 x 50 x 97 mm	309,00	1	92-157-25P

Hojas multi herramientas con forma circular para cortar metal



### 92-M\_R

			€		
115		85 mm	47,92	90	92-174-1P



Juego de hojas multi herramientas con forma estándar para cortar madera y metal (8 piezas)



### 92-Universal WM\_Set

		€		
8	32 x 160 x 195 mm	123,52	34	92-WM-SET-8P

92-222-1Px 2, 92-223-1Px 2

92-228-1Px 2

92-160-1Px 2

Hojas multiherramientas en segmentos para ranurados y trabajos de reparación



### 92-CG\_S

		€		
1	75 mm	47,92	90	92-118-1P

Hojas multiherramientas en segmentos para mármol y epoxi



### 92-DG\_S

		€		
1	90 mm	81,27	50	92-166-1P

Hojas multi herramientas con forma triangular para trabajos de raspado y repaso



### 92-CR\_T

		€		
1	80 mm	33,35	90	92-001-1P

Cuchilla multi herramienta con forma estándar para materiales blandos



### 92-MFK

		€		
1	41 x 42 x 87 mm	26,12	70	92-251-1P

Hojas multi herramientas con forma estándar para rasqueta



### 92-SC

		€		
1	52 x 38 x 83 mm	10,88	90	92-165-1P
1	50 x 38 x 83 mm	20,28	90	92-226-1P

Hojas de corte multi herramienta con forma de champiñón



### 92-CM

		€		
1	70 x 30 x 75 mm	31,56	90	92-245-1P

Almohadillas de lijado multiherramientas con forma triangular



### 92-Sanding Pads

		€		
1	80 mm	30,56	20	92-136-1P
1	93 mm	12,66	50	92-137-1P

Papel de lija triangular multiherramienta



### 92 Sanding Paper

		€		
5	82 mm	4,11	10	92-136-G40-5P
5	82 mm	4,11	10	92-136-G80-5P
5	82 mm	4,11	10	92-136-G120-5P
5	82 mm	4,11	10	92-136-G240-5P
5	94 mm	4,11	10	92-137-G40-5P
5	94 mm	4,11	10	92-137-G80-5P
5	94 mm	4,11	10	92-137-G120-5P
5	94 mm	4,11	10	92-137-G240-5P

## HOJAS PARA SIERRAS CIRCULARES

### Sierra circular para madera media



#### 8501-C

Ø	Teeth	€	Icons	Code
136 mm	24	22,85		8501-136-10-24C
136 mm	24	25,39		8501-136-20-24C
150 mm	24	27,92		8501-150-10-24C
160 mm	24	29,20		8501-160-20-24C
165 mm	24	29,20		8501-165-20-24C
184 mm	24	31,73		8501-184-20-24C
190 mm	24	38,08		8501-190-30-24C

### Sierra circular para madera media



#### 8501-P/T

Ø	Teeth	€	Icons	Code
125 mm	16	26,29		8501-2
130 mm	16	25,59		8501-3
140 mm	16	26,41		8501-4
140 mm	24	27,70		8501-4F
140 mm	30	29,14		8501-4XF
150 mm	18	30,64		8501-5
150 mm	30	32,95		8501-5F
160 mm	18	30,35		8501-7
160 mm	30	32,48		8501-7F
170 mm	18	32,95		8501-10
170 mm	30	35,29		8501-10F
180 mm	20	34,48		8501-12
180 mm	40	40,57		8501-12F
184 mm	24	37,58		8501-13
184 mm	40	39,99		8501-13F
184 mm	24	32,99		8501-184-16-24
184 mm	40	34,90		8501-184-16-40
190 mm	20	39,62		8501-15
190 mm	40	43,35		8501-15F
190 mm	60	41,25		8501-190-30-60XF
200 mm	20	48,34		8501-16
200 mm	40	52,84		8501-16F
210 mm	20	48,07		8501-17

Ø	Teeth	€	Icons	Code
210 mm	40	54,66		8501-17F
210 mm	60	48,23		8501-210-30-60XF
230 mm	20	48,90		8501-22
230 mm	40	56,34		8501-22F
230 mm	60	53,30		8501-230-30-60XF
235 mm	30	49,46		8501-23
235 mm	40	57,05		8501-23F
235 mm	60	54,57		8501-235-30-60XF
250 mm	24	62,80		8501-28
250 mm	40	65,42		8501-28F
250 mm	60	72,38		8501-28XF

### Sierra circular para madera



#### 8501-P

Ø	Teeth	€	Icons	Code
160 mm	48	29,20		8501-160-20-48XF
165 mm	48	30,47		8501-165-20-48XF

### Sierra circular para madera



#### 8501-M

Ø	Teeth	€	Icons	Code
210 mm	48	81,23		8501-210-30-48SW
216 mm	24	50,93		8501-16SW
216 mm	48	54,30		8501-18SW
216 mm	60	56,34		8501-216-60SW
250 mm	60	72,31		8501-28SW
260 mm	24	74,65		8501-260-24SW
260 mm	40	69,81		8501-260-40SW
260 mm	60	73,62		8501-260-60SW
300 mm	60	94,16		8501-30SW
305 mm	40	43,03		8501-305-30-40SW
305 mm	60	46,97		8501-305-30-60SW

### Sierra circular para madera



#### 8501-S

Ø	Teeth	€	Icons	Code
300 mm	30	82,65		8501-30
300 mm	40	85,07		8501-30F
300 mm	60	93,88		8501-30XF
315 mm	30	84,74		8501-31
315 mm	40	93,51		8501-31F
400 mm	40	111,56		8501-40

### Sierra circular para aluminio y plástico



#### 8501-AP

Ø	Teeth	€	Icons	Code
210 mm	48	54,53		8501-17S
216 mm	48	57,90		8501-18S
250 mm	80	86,49		8501-28S
260 mm	80	82,50		8501-260-30-80S
300 mm	96	111,36		8501-30S
305 mm	96	55,34		8501-305-30-96S





## DISCOS ABRASIVOS

Discos abrasivos de corte de alto rendimiento para uso general



### 391-T41\_IM

Ø	€				
230x1.9 mm	2,64	50	3911-2301922XDT		
230x2.5 mm	2,51	50	3911-2302522XDT		
75x1.0 mm	1,15	10	3911-751010XTM		
115x1.6 mm	0,96	50	3911-115-T41-IM		
115x1.0 mm	0,96	25	3911-1151T41-IM		
125x1.6 mm	1,16	50	3911-125-T41-IM		
180x2.0 mm	2,22	50	3911-180-T41-IM		
230x2.5 mm	3,17	50	3911-230-T41-IM		
115x1.0 mm	0,84	25	3912-115-T41-IM		
125x1.0 mm	0,91	25	3912-125-T41-IM		
125x1.0 mm	1,01	25	3911-1251T41-IM		
180x1.6 mm	1,74	50	3911-1801T41-IM		
230x1.9 mm	2,40	50	3911-2301T41-IM		
230x3.0 mm	2,86	50	3911-2303T41-IM		

Discos de corte abrasivos de alto rendimiento para aluminio



### 391-T41\_ALU

Ø	€				
115 mm	1,01	25	3911-115-T41-AL		
125 mm	1,01	25	3911-125-T41-AL		

Discos abrasivos de corte de alto rendimiento para inox.



### 391-T41-I

Ø	€				
115x1.0 mm	1,01	25	3911-115-T41-I		
125x1.0 mm	1,16	25	3911-125-T41-I		
150x1.0 mm	2,11	50	3911-150-T41-I		
180x1.6 mm	2,49	50	3911-180-T41-I		
230x1.9 mm	3,17	50	3911-230-T41-I		

Discos de corte abrasivos de alto rendimiento para acero inoxidable y metal



### 391-T41\_CS

Ø	€				
356 mm	5,84	35	3911-350-X2TM		
400 mm	12,04	15	3911-400-F2TM		
400 mm	12,62	15	3911-400-X2TM		

Discos abrasivos de corte de alto rendimiento para metal



### 391-T42\_M

Ø	€				
115x2.5 mm	0,91	25	3911-115-T42-M		
125x2.5 mm	1,01	25	3911-125-T42-M		
150x2.5 mm	1,70	25	3911-150-T42-M		
180x3.2 mm	2,22	25	3911-180-T42-M		
230x3.2 mm	3,17	50	3911-230-T42-M		

Discos abrasivos de corte de alto rendimiento para construcción



### 391-T42\_ST

Ø	€				
115x3.2 mm	1,06	25	3912-115-T42-ST		
125x3.2 mm	1,28	25	3912-125-T42-ST		
180x3.2 mm	1,38	25	3912-180-T42-ST		
230x3.2 mm	2,22	50	3912-230-T42-ST		

Discos abrasivos de alto rendimiento para uso general



### 392-T27\_IM

Ø	€				
115x6.4 mm	1,43	25	3921-115-T27-IM		
125x6.4 mm	1,80	25	3921-125-T27-IM		
150x6.4 mm	2,49	25	3921-150-T27-IM		
180x6.5 mm	2,86	25	3921-180-T27-IM		
230x6.5 mm	4,35	25	3921-230-T27-IM		

Discos abrasivos flexibles para desbaste de inox. y metal



### 392-FLAP\_C

Ø	€				
115 mm	3,40	20	3926-115IM-C40		
115 mm	3,40	20	3926-115IM-C60		
115 mm	3,40	20	3926-115IM-C80		
115 mm	3,40	20	3926-115IM-C120		
125 mm	4,03	20	3926-125IM-C40		
125 mm	4,03	20	3926-125IM-C60		
125 mm	4,03	20	3926-125IM-C80		
125 mm	4,03	20	3926-125IM-C120		

Discos abrasivos flexibles para inox. y metal



### 392-FLAP\_P

Ø	€			
115 mm	2,34	20	3927-115IM-P40	
115 mm	2,34	20	3927-115IM-P60	
115 mm	2,34	20	3927-115IM-P80	
115 mm	2,34	20	3927-115IM-P120	
125 mm	2,71	20	3927-125IM-P40	
125 mm	2,71	20	3927-125IM-P60	
125 mm	2,71	20	3927-125IM-P80	
125 mm	2,71	20	3927-125IM-P120	
125 mm	8,30	12	3927-125-40-3P	
125 mm	8,30	12	3927-125-60-3P	
125 mm	8,30	12	3927-125-80-3P	
125 mm	8,30	12	3927-125-120-3P	

Discos abrasivos de diamante para corte de cerámica y azulejos



### 391-DIAM\_C

Ø	€			
115 mm	17,51	100	3916-115-10P-CE	
125 mm	21,64	100	3916-125-10P-CE	
115 mm	6,68	100	3917-115-7S-C	
125 mm	8,38	100	3917-125-7S-C	

Discos abrasivos de diamante para uso general de corte en construcción



### 391-DIAM\_U

Ø	€			
115 mm	11,99	100	3916-115-10S-UE	
125 mm	14,75	100	3916-125-10S-UE	
150 mm	17,56	50	3916-150-10S-UE	

Ø	€			
180 mm	18,62	50	3916-180-10S-UE	
230 mm	26,15	25	3916-230-10S-UE	
115 mm	6,47	100	3917-115-7S-U	
125 mm	8,59	100	3917-125-7S-U	
230 mm	19,10	25	3917-230-7S-U	

Discos abrasivos de Diamante para hormigón armado



### 391-DIAM\_RC

Ø	€			
230 mm	46,36	25	3916-230-10L-RC	

## SIERRAS DE CINTA

Hojas de sierra



### 3857 Easy-Cut Portaband

		€			
S	EZ	28,62	1	3857-13-0.6-EZ-S-3P690	
S	EZ	28,62	1	3857-13-0.6-EZ-S-3P730	
S	EZ	28,62	1	3857-13-0.6-EZ-S-3P835	
S	EZ	28,62	1	3857-13-0.6-EZ-S-3P900	
S	EZ	28,62	1	3857-13-0.6-EZ-S-3P1140	
M	EZ	28,62	1	3857-13-0.6-EZ-M-3P690	
M	EZ	28,62	1	3857-13-0.6-EZ-M-3P730	
M	EZ	28,62	1	3857-13-0.6-EZ-M-3P835	
M	EZ	28,62	1	3857-13-0.6-EZ-M-3P900	
M	EZ	28,62	1	3857-13-0.6-EZ-M-3P1140	

## LIMAS ROTATIVAS DE CARBURO

Limas rotativas de Carburo de Tungsteno, cilíndrica



A

Ø		€			
3 mm	Medium	14,96	1	A0313M03	
3 mm	Medium	18,16	1	A0313M03E	
3 mm	Medium	15,57	1	A0313M03X	
3 mm	Medium	18,18	1	A0313M03XE	
3 mm	Medium	23,30	1	A0313M03XE-60	
3 mm	Medium	23,66	1	A0313M03XE-80	
6.3 mm	Medium	27,20	1	A0613M03X	
6 mm	Medium	25,97	1	A0616M06	
6 mm	Medium	29,69	1	A0616M06E	
6 mm	Medium	28,48	1	A0616M06X	
6 mm	Medium	29,69	1	A0616M06XE	
8 mm	Medium	38,00	1	A0820M06	
8 mm	Medium	44,02	1	A0820M06E	
8 mm	Medium	40,49	1	A0820M06X	
8 mm	Medium	46,45	1	A0820M06XE	
10 mm	Medium	43,61	1	A1020M06	
10 mm	Medium	50,25	1	A1020M06E	
9.6 mm	Medium	45,68	1	A1020M06X	
9.6 mm	Medium	50,25	1	A1020M06XE	
12 mm	Medium	54,63	1	A1225M06	
12.7 mm	Medium	62,91	1	A1225M06E	
12 mm	Medium	60,91	1	A1225M06X	
12.7 mm	Medium	57,63	1	A1225M08	
12.7 mm	Medium	62,91	1	A1225M08E	
12.7 mm	Medium	57,73	1	A1225M08X	
12.7 mm	Medium	66,25	1	A1225M08XE	
16 mm	Medium	68,52	1	A1625M06	
16 mm	Medium	72,05	1	A1625M06X	
16 mm	Medium	82,87	1	A1625M06XE	
16 mm	Medium	68,52	1	A1625M08	
16 mm	Medium	82,86	1	A1625M08E	
16 mm	Medium	72,05	1	A1625M08X	
16 mm	Medium	78,71	1	A1625M08XE	

F=Fino, M=Entrefino, C=Basto, EC= Extra Basto





Limas rotativas de Carburo de Tungsteno,  
Cilíndrica punta redonda



**C**

		€		
3 mm	Medium	14,96	1	C0313M03
3 mm	Medium	15,57	1	C0313M03X
6.3 mm	Medium	31,77	1	C0616M03X
6 mm	Medium	28,66	1	C0616M06
6 mm	Medium	30,11	1	C0616M06X
8 mm	Medium	41,12	1	C0820M06
8 mm	Medium	43,19	1	C0820M06X
9.6 mm	Medium	41,95	1	C1020M06
10 mm	Medium	44,02	1	C1020M06X
12 mm	Medium	62,30	1	C1225M06
12 mm	Medium	69,45	1	C1225M06X
12.7 mm	Medium	65,84	1	C1225M08X
16 mm	Medium	76,22	1	C1625M06
16 mm	Medium	79,96	1	C1625M06X
16 mm	Medium	76,22	1	C1625M08
16 mm	Medium	79,96	1	C1625M08X

F=Fino, M=Entrefino, C=Basto, EC= Extra Basto

Limas rotativas de Carburo de Tungsteno,  
ovalada



**E**

		€		
3 mm	Medium	24,48	1	E0308M03
3 mm	Medium	25,80	1	E0308M03X
6 mm	Medium	41,96	1	E0614M06
8 mm	Medium	47,54	1	E0816M06
8 mm	Medium	47,35	1	E0816M06X
9.6 mm	Medium	50,25	1	E1018M06
9.6 mm	Medium	52,75	1	E1018M06X
12.7 mm	Medium	57,73	1	E1222M06
12.7 mm	Medium	60,65	1	E1222M06X
12.7 mm	Medium	60,78	1	E1222M08
12.7 mm	Medium	63,85	1	E1222M08X
16 mm	Medium	93,04	1	E1625M06
16 mm	Medium	102,33	1	E1625M06X
16 mm	Medium	93,04	1	E1625M08
16 mm	Medium	97,60	1	E1625M08X

F=Fino, M=Entrefino, C=Basto, EC=Extra Basto

Limas rotativas de Carburo de Tungsteno



**G**

		€		
3 mm	Medium	14,96	1	G0313M03
3 mm	Medium	15,57	1	G0313M03X
6.3 mm	Medium	31,16	1	G0613M03X
6 mm	Medium	32,42	1	G0618M06
6 mm	Medium	32,20	1	G0618M06X
8 mm	Medium	41,53	1	G0820M06
8 mm	Medium	43,61	1	G0820M06X
9.6 mm	Medium	50,25	1	G1020M06
9.6 mm	Medium	52,75	1	G1020M06X
12.7 mm	Medium	58,77	1	G1225M06
12.7 mm	Medium	61,68	1	G1225M06X
12 mm	Medium	61,87	1	G1225M08
12 mm	Medium	61,68	1	G1225M08X
16 mm	Medium	79,54	1	G1625M06
16 mm	Medium	83,48	1	G1625M06X
16 mm	Medium	79,54	1	G1625M08
16 mm	Medium	83,48	1	G1625M08X

F=Fino, M=Entrefino, C=Basto, EC= Extra Basto \*Fabricación bajo pedido

Limas rotativas de Carburo de Tungsteno



**D**

		€		
3 mm	Medium	19,01	1	D0303M03
3 mm	Medium	19,90	1	D0303M03X
6.3 mm	Medium	30,60	1	D0605M03X
6 mm	Medium	29,08	1	D0606M06
6 mm	Medium	30,60	1	D0606M06X
8 mm	Medium	29,95	1	D0807M06
8 mm	Medium	31,48	1	D0807M06X
9.6 mm	Medium	31,04	1	D1009M06
10 mm	M X	39,45	1	D1009M06X-69
9.6 mm	Medium	32,56	1	D1009M06X
12.7 mm	Medium	43,28	1	D1211M06
12.7 mm	Medium	45,47	1	D1211M06X
16 mm	Medium	64,11	1	D1614M06
16 mm	Medium	63,83	1	D1614M06X
16 mm	Medium	60,77	1	D1614M08
16 mm	Medium	63,85	1	D1614M08X

F=Fino, M=Entrefino, C=Basto, EC= Extra Basto

Limas rotativas de Carburo de Tungsteno,  
Ojival punta redonda



**F**

		€		
3 mm	Medium	14,96	1	F0313M03
3 mm	Medium	15,78	1	F0313M03X
6.3 mm	Medium	32,88	1	F0613M03X
6 mm	Medium	36,76	1	F0618M06
6 mm	Medium	38,64	1	F0618M06X
8 mm	Medium	48,38	1	F0820M06
8 mm	Medium	50,88	1	F0820M06X
9.6 mm	Medium	47,14	1	F1020M06
9.6 mm	Medium	49,43	1	F1020M06X
12.7 mm	Medium	59,81	1	F1225M06
12.7 mm	Medium	62,72	1	F1225M06X
12.7 mm	Medium	59,81	1	F1225M08
12.7 mm	Medium	62,72	1	F1225M08X
16 mm	Medium	91,58	1	F1625M06
16 mm	Medium	91,17	1	F1625M06X
16 mm	Medium	91,39	1	F1625M08

F=Fino, M=Entrefino, C=Basto, EC= Extra Basto

Limas rotativas de Carburo de Tungsteno



**H**

		€		
6 mm	Medium	32,80	1	H0613M03X
10 mm	Medium	57,93	1	H1025M06
10 mm	Medium	60,77	1	H1025M06X
12.7 mm	Medium	71,48	1	H1232M06
12.7 mm	Medium	74,98	1	H1232M06X
16 mm	Medium	93,57	1	H1635M06X
16 mm	Medium	89,20	1	H1635M06
16 mm	Medium	89,20	1	H1635M08
16 mm	Medium	98,70	1	H1635M08X

F=Fino, M=Entrefino, C=Basto, EC= Extra Basto

Limas rotativas de Carburo de Tungsteno,  
Cónica 60°



**J**

Ø	Grain	€	Icons	Code
6 mm	Medium	37,58	F, M	J0604M06
9.6 mm	Medium	41,96	F, M	J1010M06
12.7 mm	Medium	49,57	F, M	J1212M06
16 mm	Medium	72,64	F, M	J1616M06
16 mm	Medium	68,86	F, M	J1616M08

F=Fino, M=Entrefino, C=Basto, EC= Extra Basto \*Fabricación bajo pedido

Limas rotativas de Carburo de Tungsteno,  
Cónica 90°



**K**

Ø	Grain	€	Icons	Code
6 mm	Medium	37,58	F, M	K0602M06
9.6 mm	Medium	44,28	F, M	K1008M06
12.7 mm	Medium	46,99	F, M	K1210M06
16 mm	Medium	64,57	F, M	K1612M06
16 mm	Medium	61,21	F, M	K1612M08

F=Fino, M=Entrefino, C=Basto, EC= Extra Basto

Limas rotativas de Carburo de Tungsteno,  
Cónica punta redonda



**L**

Ø	Grain	€	Icons	Code
10 mm	Medium	59,97	F, M	L1020M06
10 mm	Medium	62,97	F, M	L1020M06X
12.7 mm	Medium	66,67	F, M	L1225M06
12.7 mm	Medium	73,80	F, M	L1225M06X
12.7 mm	Medium	75,42	F, M	L1230M06
12.7 mm	Medium	74,98	F, M	L1230M06X
16 mm	Medium	78,89	F, M	L1630M06
16 mm	Medium	82,79	F, M	L1630M06X
16 mm	Medium	78,89	F, M	L1630M08
16 mm	Medium	82,79	F, M	L1630M08X

F=Fino, M=Entrefino, C=Basto, EC= Extra Basto

Limas rotativas de Carburo de Tungsteno,  
Cónica con punta



**M**

Ø	Grain	€	Icons	Code
3 mm	Medium	20,37	F, M	M0310M03
3 mm	Medium	20,35	F, M	M0310M03X
6.3 mm	Medium	31,16	F, M	M0613M03X
6 mm	Medium	35,71	F, M	M0618M06
6 mm	Medium	35,51	F, M	M0618M06X
9.5 mm	Medium	43,17	F, M	M1022M06
9.5 mm	Medium	42,99	F, M	M1022M06X
12.7 mm	Medium	55,43	F, M	M1227M06
12.7 mm	Medium	55,24	F, M	M1227M06X
12.7 mm	Medium	55,32	F, M	M1227M08
16 mm	Medium	91,58	F, M	M1630M06
16 mm	Medium	91,17	F, M	M1630M06X
16 mm	Medium	91,58	F, M	M1630M08
16 mm	Medium	91,17	F, M	M1630M08X

F=Fino, M=Entrefino, C=Basto, EC=Extra Basto

Limas rotativas de Carburo de Tungsteno,  
Cónica invertida



**N**

Ø	Grain	€	Icons	Code
3 mm	Medium	19,60	F, M	N0306M03
3 mm	Medium	21,43	F, M	N0306M03E
6 mm	Medium	30,60	F, M	N0607M06
12.7 mm	Medium	48,89	F, M	N1213M06
12.7 mm	Medium	48,68	F, M	N1213M06X
16 mm	Medium	63,88	F, M	N1613M06
16 mm	Medium	63,60	F, M	N1613M06X
16 mm	Medium	63,88	F, M	N1613M08

F=Fino, M=Entrefino, C=Basto, EC= Extra Basto

Limas rotativas de Carburo de Tungsteno



**A-AL**

Ø	Material	€	Icons	Code
6 mm	AL	35,72	F, M	A0616AL06E
12.7 mm	AL	65,62	F, M	A1225AL06E
12.7 mm	AL	65,62	F, M	A1225AL08E
16 mm	AL	108,55	F, M	A1625AL08XE

Limas rotativas de Carburo de Tungsteno



**C-AL**

Ø	Material	€	Icons	Code
6 mm	AL	34,46	F, M	C0616AL06
12.7 mm	AL	65,84	F, M	C1225AL06

Limas rotativas de Carburo de Tungsteno



**D-AL**

Ø	Material	€	Icons	Code
12.7 mm	AL	52,04	F, M	D1211AL06
12.7 mm	AL	52,04	F, M	D1211AL08



Limas rotativas de Carburo de Tungsteno



**F-AL**

Ø	Material	€	Paquete	Forma
6 mm	AL	44,02	1	F0618AL06
12.7 mm	AL	59,81	1	F1225AL06
12.7 mm	AL	59,81	1	F1225AL08

Limas rotativas cilíndricas de carburo de tungsteno para acero de alta aleación



**A-S**

Ø	Material	€	Paquete	Forma
6 mm	Steel	21,35	5	A0618S06E
9.6 mm	Steel	27,33	5	A1020S06
9.6 mm	Steel	30,06	5	A1020S06E
12.7 mm	Steel	42,67	5	A1225S06
12.7 mm	Steel	46,93	5	A1225S06E

Limas rotativas ojivales con punta redonda de carburo de tungsteno para acero de alta aleación



**F-S**

Ø	Material	€	Paquete	Forma
6 mm	Steel	23,62	5	F0618S06
9.6 mm	Steel	29,78	5	F1020S06
12.7 mm	Steel	44,04	5	F1225S06

Limas rotativas de Carburo de Tungsteno



**L-AL**

Ø	Material	€	Paquete	Forma
12.7 mm	AL	90,39	1	L1230AL06
12.7 mm	AL	90,39	1	L1230AL08

Limas rotativas cilíndricas de punta redonda de carburo de tungsteno para acero de alta aleación



**C-S**

Ø	Material	€	Paquete	Forma
6 mm	Steel	22,63	5	C0618S06
9.6 mm	Steel	30,45	5	C1020S06
12.7 mm	Steel	47,85	5	C1225S06

Limas rotativas ojivales con punta de carburo de tungsteno para acero de alta aleación



**G-S**

Ø	Material	€	Paquete	Forma
9.6 mm	Steel	31,77	5	G1020S06
12.7 mm	Steel	43,21	5	G1225S06

Limas rotativas de Carburo de Tungsteno



**A/G**

Ø	Material	€	Paquete	Forma
6 mm	TR	33,03	1	A0625M06X

Limas rotativas esféricas de carburo de tungsteno para acero de alta aleación



**D-S**

Ø	Material	€	Paquete	Forma
6 mm	Steel	20,78	5	D0606S06
9.6 mm	Steel	24,97	5	D1010S06
12.7 mm	Steel	33,68	5	D1212S06

Limas rotativas cónicas con punta redonda de carburo de tungsteno para acero de alta aleación



**L-S**

Ø	Material	€	Paquete	Forma
9.6 mm	Steel	38,09	5	L1020S06
12.7 mm	Steel	46,50	5	L1228S06

Limas rotativas cilíndricas de carburo de tungsteno para acero inoxidable



**A-I**

		€		
3 mm	Inox	13,91	5	A0314I03
6 mm	Inox	21,19	5	A0618I06
9.6 mm	Inox	29,81	5	A1020I06
12.7 mm	Inox	57,08	5	A1225I06

Limas rotativas ovaladas de carburo de tungsteno para acero inoxidable



**E-I**

		€		
9.6 mm	Inox	33,20	5	E1015I06
12.7 mm	Inox	48,63	5	E1220I06

Limas rotativas en forma de llama de carburo de tungsteno para acero inoxidable



**H-I**

		€		
9.6 mm	Inox	59,17	5	H1020I06
12.7 mm	Inox	69,58	5	H1232I06

Limas rotativas cilíndricas de punta redonda de carburo de tungsteno para acero inoxidable



**C-I**

		€		
3 mm	Inox	13,91	5	C0312I03
6 mm	Inox	24,66	5	C0618I06
9.6 mm	Inox	33,20	5	C1020I06
12.7 mm	Inox	63,07	5	C1225I06

Limas rotativas ojivales con punta redonda de carburo de tungsteno para acero inoxidable



**F-I**

		€		
3 mm	Inox	13,91	5	F0312I03
6 mm	Inox	25,75	5	F0618I06
9.6 mm	Inox	32,50	5	F1020I06
12.7 mm	Inox	48,06	5	F1225I06

Limas rotativas cónicas con punta redonda de carburo de tungsteno para acero inoxidable



**L-I**

		€		
9.6 mm	Inox	41,53	5	L1020I06
12.7 mm	Inox	50,74	5	L1228I06

Limas rotativas esféricas de carburo de tungsteno para acero inoxidable



**D-I**

		€		
3 mm	Inox	13,91	5	D0303I03
6 mm	Inox	22,67	5	D0606I06
9.6 mm	Inox	27,25	5	D1010I06
12.7 mm	Inox	36,76	5	D1212I06

Limas rotativas ojivales con punta de carburo de tungsteno para acero inoxidable



**G-I**

		€		
9.6 mm	Inox	34,67	5	G1020I06
12.7 mm	Inox	47,13	5	G1225I06

Limas rotativas ojivales con punta de carburo de tungsteno para reparación de neumáticos



**TR**

		€		
3 mm	Tire Repair	23,23	5	TR0325M03X-50
4.5 mm	Tire Repair	43,22	5	TR0636M06X-65
6 mm	Tire Repair	48,55	5	TR0650M06X-80
8 in	Tire Repair	63,92	5	TR0860M08X-110
8 mm	Tire Repair	41,50	5	TR4.530M06X-90



Juego de limas rotativas de carburo de tungsteno para metal, 10 y 12 mm, 5 piezas



### ST-1-5P

		€		
5	376 g	206,96	1	RB-SET1-M06X-5P

A1020M06XE	
C1225M06X	
F1225M06X	
G1020M06X	
L1230M06X	

Juego de limas rotativas de carburo de tungsteno para metal, 10 mm, 5 piezas



### ST-2-5P

		€		
5	313 g	164,03	1	RB-SET2-M06X-5P

A1020M06XE	
C1020M06X	
D1009M06X	
F1020M06X	
L1020M06X	

Juego de limas rotativas de carburo de tungsteno para metal, 10 piezas



### ST-10P

		€		
10	542 g	391,92	1	RB-SET-M06X-10P

A1020M06XE, A1225M06X	
C1020M06X, C1225M06X	
D1211M06X	
E1018M06X	
F1225M06X	
G1020M06X, G1225M06X	
L1230M06X	

Juego de limas rotativas de carburo de tungsteno para aluminio, 5 piezas



### ALU-5P

		€		
5	380 g	362,88	1	RB-SET-AL06-5P

A1225AL06E	
C1225AL06	
D1211AL06	
F1225AL06	
L1230AL06	

## BROCAS

Broca para cemento, SDS Max best



### 4656

Ø	L	€		
12.0 mm	340 mm	65,28	1	4656-12-340
12.0 mm	540 mm	76,59	1	4656-12-540
14.0 mm	340 mm	70,12	1	4656-14-340
14.0 mm	540 mm	80,38	1	4656-14-540
15.0 mm	340 mm	80,92	1	4656-15-340
16.0 mm	340 mm	83,62	1	4656-16-340
16.0 mm	540 mm	87,39	1	4656-16-540
16.0 mm	940 mm	161,82	1	4656-16-940
16.0 mm	1320 mm	280,50	1	4656-16-1320
18.0 mm	340 mm	85,78	1	4656-18-340
18.0 mm	540 mm	102,50	1	4656-18-540

Ø	L	€		
18.0 mm	940 mm	156,44	1	4656-18-940
18.0 mm	1320 mm	296,68	1	4656-18-1320
20.0 mm	320 mm	80,92	1	4656-20-320
20.0 mm	520 mm	104,65	1	4656-20-520
20.0 mm	920 mm	148,88	1	4656-20-920
20.0 mm	1320 mm	350,62	1	4656-20-1320
22.0 mm	320 mm	99,25	1	4656-22-320
22.0 mm	520 mm	118,67	1	4656-22-520
22.0 mm	920 mm	161,82	1	4656-22-920
22.0 mm	1320 mm	377,60	1	4656-22-1320
24.0 mm	320 mm	96,03	1	4656-24-320
24.0 mm	520 mm	118,67	1	4656-24-520
25.0 mm	320 mm	105,73	1	4656-25-320
25.0 mm	520 mm	129,46	1	4656-25-520
25.0 mm	920 mm	192,03	1	4656-25-920
25.0 mm	1320 mm	408,89	1	4656-25-1320
26.0 mm	520 mm	129,46	1	4656-26-520
28.0 mm	370 mm	127,30	1	4656-28-370
28.0 mm	570 mm	139,17	1	4656-28-570
28.0 mm	670 mm	175,85	1	4656-28-670
28.0 mm	920 mm	210,38	1	4656-28-920
30.0 mm	370 mm	139,17	1	4656-30-370
30.0 mm	570 mm	148,88	1	4656-30-570
32.0 mm	370 mm	145,65	1	4656-32-370
32.0 mm	570 mm	181,25	1	4656-32-570
32.0 mm	920 mm	247,06	1	4656-32-920
32.0 mm	1320 mm	420,74	1	4656-32-1320
35.0 mm	370 mm	160,75	1	4656-35-370
35.0 mm	570 mm	193,11	1	4656-35-570
35.0 mm	670 mm	226,56	1	4656-35-670
37.0 mm	370 mm	161,82	1	4656-37-370
37.0 mm	570 mm	193,11	1	4656-37-570
37.0 mm	920 mm	291,28	1	4656-37-920
38.0 mm	370 mm	280,50	1	4656-38-370
38.0 mm	570 mm	193,11	1	4656-38-570
40.0 mm	370 mm	188,80	1	4656-40-370
40.0 mm	570 mm	231,96	1	4656-40-570
40.0 mm	920 mm	302,08	1	4656-40-920
40.0 mm	1320 mm	507,06	1	4656-40-1320
45.0 mm	570 mm	312,86	1	4656-45-570
45.0 mm	920 mm	430,46	1	4656-45-920
50.0 mm	570 mm	377,60	1	4656-50-570
52.0 mm	570 mm	442,32	1	4656-52-570

Broca para cemento, SDS best



### 4651

Ø	L	€		
5.0 mm	115 mm	8,10	1	4651-5-110
5.0 mm	110 mm	80,97	1	4651-5-110-10P
5.0 mm	165 mm	9,06	1	4651-5-160
5.0 mm	160 mm	90,62	1	4651-5-160-10P
5.0 mm	265 mm	16,83	1	4651-5-260
5.5 mm	110 mm	110,05	10	4651-5,5-110-10P
5.5 mm	160 mm	114,36	1	4651-5,5-160-10P
5.5 mm	115 mm	11,01	1	4651-5,5-110
5.5 mm	165 mm	11,44	1	4651-5,5-160



∅	L	€		
6.0 mm	115 mm	8,10	1	4651-6-110
6.0 mm	110 mm	80,97	1	4651-6-110-10P
6.0 mm	165 mm	8,85	1	4651-6-160
6.0 mm	160 mm	77,41	1	4651-6-160-10P
6.0 mm	215 mm	11,99	1	4651-6-210
6.0 mm	265 mm	14,23	1	4651-6-260
6.0 mm	315 mm	21,04	1	4651-6-310
6.5 mm	110 mm	11,42	50	4651-6,5-110
6.5 mm	165 mm	11,56	1	4651-6,5-160
6.5 mm	160 mm	114,36	1	4651-6,5-160-10P
6.5 mm	215 mm	15,54	1	4651-6,5-210
6.5 mm	265 mm	20,72	1	4651-6,5-260
6.5 mm	315 mm	25,25	1	4651-6,5-310
7.0 mm	115 mm	10,91	1	4651-7-110
7.0 mm	165 mm	11,56	1	4651-7-160
8.0 mm	115 mm	10,57	1	4651-8-110
8.0 mm	165 mm	10,68	1	4651-8-160
8.0 mm	160 mm	106,87	1	4651-8-160-10P
8.0 mm	215 mm	13,28	1	4651-8-210
8.0 mm	210 mm	132,76	1	4651-8-210-10P
8.0 mm	265 mm	14,57	1	4651-8-260
8.0 mm	315 mm	18,67	1	4651-8-310
8.0 mm	465 mm	30,86	1	4651-8-460
10.0 mm	115 mm	12,08	1	4651-10-110
10.0 mm	165 mm	12,84	1	4651-10-160
10.0 mm	160 mm	128,45	1	4651-10-160-10P
10.0 mm	215 mm	15,32	1	4651-10-210
10.0 mm	210 mm	161,18	1	4651-10-210-10P
10.0 mm	265 mm	19,85	1	4651-10-260
10.0 mm	315 mm	25,25	1	4651-10-310
10.0 mm	455 mm	34,53	1	4651-10-450
10.0 mm	600 mm	44,01	1	4651-10-600
10.0 mm	1000 mm	103,35	1	4651-10-1000
12.0 mm	160 mm	16,09	1	4651-12-160
12.0 mm	160 mm	160,81	1	4651-12-160-10P
12.0 mm	210 mm	19,21	1	4651-12-210
12.0 mm	210 mm	192,03	1	4651-12-210-10P
12.0 mm	260 mm	23,21	1	4651-12-260
12.0 mm	310 mm	30,11	1	4651-12-310
12.0 mm	450 mm	37,67	1	4651-12-450
12.0 mm	600 mm	45,22	1	4651-12-600
12.0 mm	1000 mm	103,78	1	4651-12-1000
14.0 mm	160 mm	18,56	1	4651-14-160
14.0 mm	210 mm	24,82	1	4651-14-210
14.0 mm	260 mm	27,51	1	4651-14-260
14.0 mm	310 mm	35,50	1	4651-14-310
14.0 mm	450 mm	44,67	1	4651-14-450
14.0 mm	600 mm	62,36	1	4651-14-600
14.0 mm	1000 mm	139,17	1	4651-14-1000
15.0 mm	160 mm	28,59	1	4651-15-160
15.0 mm	260 mm	37,22	1	4651-15-260
15.0 mm	450 mm	48,23	1	4651-15-450
16.0 mm	160 mm	35,50	1	4651-16-160
16.0 mm	210 mm	39,81	1	4651-16-210
16.0 mm	260 mm	46,07	1	4651-16-260
16.0 mm	310 mm	48,01	1	4651-16-310
16.0 mm	450 mm	60,31	1	4651-16-450
16.0 mm	600 mm	80,92	1	4651-16-600
16.0 mm	1000 mm	165,07	1	4651-16-1000
18.0 mm	250 mm	61,72	1	4651-18-250
18.0 mm	450 mm	72,49	1	4651-18-450
20.0 mm	250 mm	70,12	1	4651-20-250
20.0 mm	450 mm	82,97	1	4651-20-450
22.0 mm	250 mm	84,05	1	4651-22-250
22.0 mm	450 mm	100,01	1	4651-22-450
24.0 mm	250 mm	85,41	1	4651-24-250
24.0 mm	450 mm	105,83	1	4651-24-450
25.0 mm	250 mm	87,75	1	4651-25-250
25.0 mm	450 mm	107,35	1	4651-25-450
28.0 mm	250 mm	101,41	1	4651-28-250
28.0 mm	450 mm	122,99	1	4651-28-450
30.0 mm	250 mm	129,71	1	4651-30-250
30.0 mm	450 mm	134,86	1	4651-30-450
32.0 mm	450 mm	174,78	1	4651-32-450

### Juego de 5 brocas SDS para hormigón armado



#### 4651-SET-5

	€		
5	45,06	1	4651-SET-5

4651-5-110, 4651-6-110, 4651-6-160, 4651-8-160, 4651-10-160

### Juego de 7 brocas SDS para hormigón armado



#### 4651-SET-7

	€		
7	68,40	1	4651-SET-7

4651-5-110, 4651-6-110, 4651-8-110, 4651-6-160, 4651-8-160, 4651-10-160, 4651-12-160

### Brocas para cemento, SDS



#### 4652

∅	L	€		
3.0 mm	110 mm	8,63	50	4652-3-110
3.5 mm	110 mm	8,63	50	4652-3,5-110
4.0 mm	110 mm	5,93	1	4652-4-110
4.0 mm	160 mm	7,12	1	4652-4-160
5.0 mm	110 mm	4,30	1	4652-5-110
5.0 mm	160 mm	5,61	1	4652-5-160
5.0 mm	110 mm	43,03	1	4652-5-110-10P
5.0 mm	160 mm	56,09	1	4652-5-160-10P
5.0 mm	210 mm	8,85	1	4652-5-210
5.5 mm	110 mm	5,08	1	4652-5,5-110
5.5 mm	110 mm	50,77	10	4652-5,5-110-10P
5.5 mm	160 mm	6,38	1	4652-5,5-160

∅	L	€		
5.5 mm	160 mm	63,72	1	4652-5,5-160-10P
5.5 mm	210 mm	8,63	50	4652-5,5-210
6.0 mm	110 mm	4,43	1	4652-6-110
6.0 mm	110 mm	44,30	1	4652-6-110-10P
6.0 mm	160 mm	5,18	50	4652-6-160
6.0 mm	160 mm	51,79	1	4652-6-160-10P
6.0 mm	210 mm	8,42	1	4652-6-210
6.0 mm	260 mm	10,77	1	4652-6-260
6.5 mm	110 mm	5,08	1	4652-6,5-110
6.5 mm	160 mm	5,93	1	4652-6,5-160
6.5 mm	160 mm	59,40	1	4652-6,5-160-10P
7.0 mm	110 mm	6,38	1	4652-7-110
7.0 mm	160 mm	6,81	1	4652-7-160
8.0 mm	110 mm	5,29	1	4652-8-110
8.0 mm	160 mm	5,61	1	4652-8-160
8.0 mm	160 mm	56,09	1	4652-8-160-10P
8.0 mm	210 mm	7,54	1	4652-8-210
8.0 mm	210 mm	75,40	1	4652-8-210-10P
8.0 mm	260 mm	10,68	1	4652-8-260
8.0 mm	460 mm	22,56	1	4652-8-460
9.0 mm	160 mm	8,53	1	4652-9-160
9.0 mm	210 mm	9,28	1	4652-9-210
10.0 mm	110 mm	6,38	1	4652-10-110
10.0 mm	160 mm	7,12	1	4652-10-160
10.0 mm	160 mm	71,20	1	4652-10-160-10P
10.0 mm	210 mm	8,53	1	4652-10-210
10.0 mm	210 mm	85,29	1	4652-10-210-10P
10.0 mm	260 mm	12,51	1	4652-10-260
10.0 mm	310 mm	14,57	1	4652-10-310
10.0 mm	450 mm	23,64	1	4652-10-450
10.0 mm	600 mm	33,02	1	4652-10-600
11.0 mm	160 mm	9,39	1	4652-11-160
11.0 mm	260 mm	14,57	1	4652-11-260
12.0 mm	160 mm	7,54	1	4652-12-160
12.0 mm	160 mm	75,40	1	4652-12-160-10P
12.0 mm	210 mm	9,61	1	4652-12-210
12.0 mm	210 mm	96,08	1	4652-12-210-10P
12.0 mm	260 mm	13,71	1	4652-12-260
12.0 mm	310 mm	18,23	1	4652-12-310
12.0 mm	450 mm	21,48	1	4652-12-450
12.0 mm	600 mm	34,21	1	4652-12-600
12.0 mm	1000 mm	81,68	1	4652-12-1000
13.0 mm	310 mm	17,69	1	4652-13-310
14.0 mm	160 mm	10,36	1	4652-14-160
14.0 mm	210 mm	15,15	1	4652-14-210
14.0 mm	260 mm	18,23	1	4652-14-260
14.0 mm	310 mm	19,21	1	4652-14-310
14.0 mm	450 mm	25,25	1	4652-14-450
14.0 mm	600 mm	37,44	1	4652-14-600
14.0 mm	1000 mm	88,80	1	4652-14-1000
15.0 mm	260 mm	18,88	1	4652-15-260
16.0 mm	210 mm	17,59	1	4652-16-210
16.0 mm	260 mm	18,99	1	4652-16-260
16.0 mm	310 mm	20,28	1	4652-16-310
16.0 mm	450 mm	29,98	1	4652-16-450
16.0 mm	600 mm	40,35	1	4652-16-600
16.0 mm	1000 mm	100,88	1	4652-16-1000
18.0 mm	200 mm	22,56	1	4652-18-200
18.0 mm	300 mm	30,11	1	4652-18-300
18.0 mm	450 mm	34,31	1	4652-18-450
18.0 mm	1000 mm	103,69	1	4652-18-1000
20.0 mm	200 mm	31,40	1	4652-20-200
20.0 mm	300 mm	35,29	1	4652-20-300
20.0 mm	450 mm	44,44	1	4652-20-450
20.0 mm	600 mm	65,82	1	4652-20-600
20.0 mm	1000 mm	104,65	1	4652-20-1000
22.0 mm	250 mm	40,35	1	4652-22-250
22.0 mm	450 mm	56,09	1	4652-22-450
22.0 mm	600 mm	67,22	1	4652-22-600
22.0 mm	1000 mm	105,73	1	4652-22-1000
24.0 mm	250 mm	46,94	1	4652-24-250
24.0 mm	450 mm	61,07	1	4652-24-450
25.0 mm	250 mm	50,92	1	4652-25-250
25.0 mm	450 mm	65,37	1	4652-25-450
25.0 mm	1000 mm	117,60	1	4652-25-1000
26.0 mm	250 mm	63,65	1	4652-26-250
26.0 mm	450 mm	72,29	1	4652-26-450



Juego de 5 brocas SDS para hormigón armado



**4652-SET-5**

	€		
5	19,03	1	4652-SET-5

4652-5-110, 4652-6-110, 4652-6-160,  
4652-8-160, 4652-10-160

Juego de 7 brocas SDS para hormigón armado



**4652-SET-7**

	€		
7	29,69	1	4652-SET-7

4652-5-110, 4652-6-110, 4652-8-110,  
4652-6-160, 4652-8-160, 4652-10-160,  
4652-12-160

Brocas para cemento



**4641**

		€		
3.0 mm	60 mm	3,37	1	4641-3-60
4.0 mm	75 mm	3,54	1	4641-4-75
5.0 mm	85 mm	3,71	1	4641-5-85

		€		
5.0 mm	150 mm	4,89	1	4641-5-150
5.5 mm	85 mm	3,71	1	4641-5,5-85
6.0 mm	100 mm	3,82	1	4641-6-100
6.0 mm	150 mm	5,08	1	4641-6-150
6.0 mm	400 mm	12,69	1	4641-6-400
6.5 mm	100 mm	3,82	1	4641-6,5-100
7.0 mm	100 mm	4,32	1	4641-7-100
8.0 mm	120 mm	5,01	1	4641-8-120
8.0 mm	200 mm	7,36	1	4641-8-200
8.0 mm	400 mm	13,45	1	4641-8-400
9.0 mm	120 mm	5,01	1	4641-9-120
10.0 mm	120 mm	5,65	1	4641-10-120
10.0 mm	200 mm	8,74	1	4641-10-200
10.0 mm	400 mm	14,37	1	4641-10-400
10.0 mm	600 mm	15,91	1	4641-10-600
11.0 mm	150 mm	6,54	1	4641-11-150
12.0 mm	150 mm	7,68	1	4641-12-150
12.0 mm	200 mm	10,85	1	4641-12-200
12.0 mm	400 mm	15,26	1	4641-12-400
12.0 mm	600 mm	17,31	1	4641-12-600
13.0 mm	150 mm	10,85	1	4641-13-150
14.0 mm	150 mm	12,63	1	4641-14-150
14.0 mm	400 mm	18,75	1	4641-14-400
14.0 mm	600 mm	21,00	1	4641-14-600
16.0 mm	150 mm	13,96	1	4641-16-150
16.0 mm	400 mm	20,83	1	4641-16-400
16.0 mm	600 mm	26,80	1	4641-16-600
18.0 mm	400 mm	30,41	1	4641-18-400
18.0 mm	600 mm	36,08	1	4641-18-600
20.0 mm	400 mm	32,23	1	4641-20-400
20.0 mm	600 mm	41,81	1	4641-20-600
22.0 mm	400 mm	37,04	1	4641-22-400
24.0 mm	400 mm	38,40	1	4641-24-400
25.0 mm	400 mm	43,86	1	4641-25-400

Juego de 5 brocas para cemento



**4641-PB**

		€		
5	185 g	22,15	1	4641-PB

4641-4-75, 4641-5-85, 4641-6-100, 4641-8-120,  
4641-10-120

Juego de 5 brocas para albañilería con punta de carburo



**4643-PB**

		€		
5	150 g	13,01	1	4643-PB

4mm, 5mm, 6mm, 8mm and 10mm

Cinceles para cemento, cinceles SDS Max



**4659**

		€		
- mm	280 mm	17,26	1	4659-POINT-28
- mm	400 mm	20,61	1	4659-POINT-40
- mm	600 mm	27,84	1	4659-POINT-60
24.0 mm	280 mm	17,81	1	4659-FLAT-28
24.0 mm	400 mm	20,61	1	4659-FLAT-40
24.0 mm	600 mm	26,76	1	4659-FLAT-60
80.0 mm	300 mm	46,17	1	4659-WIDE-30-8
50.0 mm	360 mm	30,76	1	4659-WIDE-36-5
50.0 mm	300 mm	48,77	1	4659-TILE-30-5
80.0 mm	300 mm	51,25	1	4659-TILE-30-8

Brocas para cemento, cincel SDS



**4655**

		€		
20.0 mm	250 mm	11,44	1	4655-FLAT-250
22.0 mm	240 mm	23,51	1	4655-HOLLOW-240
- mm	250 mm	11,44	1	4655-POINT-250
32.0 mm	200 mm	151,04	1	4655-SLOT-25032
38.0 mm	200 mm	22,23	1	4655-TILE-20040
38.0 mm	200 mm	19,42	1	4655-WIDE-20040
22.0 mm	250 mm	56,64	1	4655-WING-C-250

Broca para metal HSS-E, Cobalto



**4411**

Ø	L	€		
1.00 mm	34 mm	4,86	1	4411-1.00
1.50 mm	40 mm	4,53	1	4411-1.50
2.00 mm	49 mm	4,75	1	4411-2.00
2.50 mm	57 mm	4,26	1	4411-2.50
3.00 mm	61 mm	4,10	1	4411-3.00
3.25 mm	65 mm	4,96	1	4411-3.25
3.30 mm	65 mm	4,96	1	4411-3.30
3.50 mm	70 mm	4,86	1	4411-3.50
4.00 mm	75 mm	5,29	1	4411-4.00
4.20 mm	75 mm	2,91	1	4411-4.20
4.25 mm	75 mm	2,91	1	4411-4.25
4.50 mm	80 mm	3,02	1	4411-4.50
5.00 mm	86 mm	3,13	1	4411-5.00
5.50 mm	93 mm	3,93	1	4411-5.50
6.00 mm	93 mm	4,10	1	4411-6.00
6.50 mm	101 mm	4,86	1	4411-6.50
6.80 mm	109 mm	4,65	1	4411-6.80
7.00 mm	109 mm	5,29	1	4411-7.00
7.50 mm	109 mm	5,73	1	4411-7.50
8.00 mm	117 mm	6,68	1	4411-8.00
8.50 mm	117 mm	7,01	1	4411-8.50
9.00 mm	125 mm	8,85	1	4411-9.00
9.50 mm	125 mm	8,96	1	4411-9.50
10.00 mm	125 mm	9,83	1	4411-10.00
10.20 mm	133 mm	13,93	1	4411-10.20
10.50 mm	133 mm	14,60	1	4411-10.50
11.00 mm	142 mm	15,32	1	4411-11.00
11.50 mm	142 mm	17,46	1	4411-11.50
12.00 mm	151 mm	19,64	1	4411-12.00
12.50 mm	151 mm	22,02	1	4411-12.50
13.00 mm	151 mm	24,49	1	4411-13.00

Broca para metal HSS-E, Cobalto



**4511**

Ø	L	€		
0.50 mm	22 mm	27,40	1	4511-0.50-10P
0.75 mm	28 mm	24,76	1	4511-0.75-10P
1.00 mm	34 mm	20,06	1	4511-1.00-10P
1.50 mm	40 mm	19,11	1	4511-1.50-10P
1.75 mm	46 mm	23,95	1	4511-1.75-10P
2.00 mm	49 mm	20,06	1	4511-2.00-10P
2.50 mm	57 mm	18,23	1	4511-2.50-10P
2.70 mm	61 mm	22,60	1	4511-2.70-10P
2.90 mm	61 mm	22,60	1	4511-2.90-10P
3.00 mm	61 mm	17,81	1	4511-3.00-10P
3.10 mm	65 mm	21,78	1	4511-3.10-10P
3.25 mm	65 mm	21,78	1	4511-3.25-10P
3.30 mm	65 mm	21,78	1	4511-3.30-10P
3.50 mm	70 mm	21,78	1	4511-3.50-10P
3.80 mm	75 mm	27,40	1	4511-3.80-10P
4.00 mm	75 mm	23,09	1	4511-4.00-10P
4.20 mm	75 mm	25,68	1	4511-4.20-10P
4.50 mm	80 mm	25,88	1	4511-4.50-10P
4.80 mm	86 mm	30,43	1	4511-4.80-10P
5.00 mm	86 mm	27,40	1	4511-5.00-10P

Ø	L	€		
5.20 mm	86 mm	33,12	1	4511-5.20-10P
5.50 mm	93 mm	34,74	1	4511-5.50-10P
6.00 mm	93 mm	36,89	1	4511-6.00-10P
6.20 mm	101 mm	46,17	1	4511-6.20-10P
6.50 mm	101 mm	44,34	1	4511-6.50-10P
6.80 mm	109 mm	51,69	1	4511-6.80-10P
7.00 mm	109 mm	48,66	1	4511-7.00-10P
7.20 mm	109 mm	70,39	1	4511-7.20-10P
7.50 mm	109 mm	51,69	1	4511-7.50-10P
7.80 mm	117 mm	84,70	1	4511-7.80-10P
8.00 mm	117 mm	60,84	1	4511-8.00-10P
8.50 mm	117 mm	63,01	1	4511-8.50-10P
8.60 mm	125 mm	103,04	1	4511-8.60-10P
8.80 mm	125 mm	103,04	1	4511-8.80-10P
9.00 mm	125 mm	80,92	1	4511-9.00-10P
9.20 mm	125 mm	114,26	1	4511-9.20-10P
9.50 mm	125 mm	83,62	1	4511-9.50-10P
9.60 mm	133 mm	134,32	1	4511-9.60-10P
10.00 mm	133 mm	45,87	1	4511-10.00-5P
10.20 mm	133 mm	64,74	1	4511-10.20-5P
10.30 mm	133 mm	77,14	1	4511-10.30-5P
10.50 mm	133 mm	64,94	1	4511-10.50-5P
10.80 mm	142 mm	89,76	1	4511-10.80-5P
11.00 mm	142 mm	71,75	1	4511-11.00-5P
11.50 mm	142 mm	85,78	1	4511-11.50-5P
12.00 mm	151 mm	91,93	1	4511-12.00-5P
12.50 mm	151 mm	111,93	1	4511-12.50-5P
12.80 mm	151 mm	127,84	1	4511-12.80-5P
13.00 mm	151 mm	114,36	1	4511-13.00-5P
13.50 mm	160 mm	25,25	1	4511-13.50-1P
14.00 mm	160 mm	24,93	1	4511-14.00-1P
14.50 mm	169 mm	35,39	1	4511-14.50-1P
15.00 mm	169 mm	35,94	1	4511-15.00-1P
15.50 mm	169 mm	41,64	1	4511-15.50-1P
16.00 mm	178 mm	43,05	1	4511-16.00-1P
16.50 mm	184 mm	49,19	1	4511-16.50-1P
17.00 mm	184 mm	49,19	1	4511-17.00-1P
17.50 mm	191 mm	54,59	1	4511-17.50-1P
18.00 mm	191 mm	59,45	1	4511-18.00-1P
18.50 mm	198 mm	65,59	1	4511-18.50-1P
19.00 mm	198 mm	65,71	1	4511-19.00-1P
19.50 mm	205 mm	72,83	1	4511-19.50-1P
20.00 mm	205 mm	78,01	1	4511-20.00-1P

Juego de 6 brocas para metal, Cobalto



**4511-SET-6**

X	g	€		
6	150 g	20,94	1	4511-SET-6

2.0 a 8.0 mm x 1.0 mm (excl. 7.0 mm) en un soporte de plástico

4411-2.00, 4411-3.00, 4411-4.00, 4411-5.00, 4411-6.00, 4411-8.00

Juego de 19 brocas para metal, Cobalto



**4511-SET-19**

X	g	€		
19	600 g	85,13	1	4511-SET-19

1.0 a 10.0 mm x 0.5 mm en caja de plástico

4411-1.00, 4411-1.50, 4411-2.00, 4411-2.50, 4411-3.00, 4411-3.50, 4411-4.00, 4411-4.50, 4411-5.00, 4411-5.50, 4411-6.00, 4411-6.50, 4411-7.00, 4411-7.50, 4411-8.00, 4411-8.50, 4411-9.00, 4411-9.50, 4411-10.00

Juego de 25 brocas para metal, Cobalto



**4511-SET-25**

X	g	€		
25	1200 g	199,58	1	4511-SET-25

1pc 13.0mm



## Broca para metal HSS-G



### 4413



Ø	L	€		
1.00 mm	34 mm	3,55	1	4413-1.00
1.50 mm	40 mm	2,81	1	4413-1.50
2.00 mm	49 mm	2,81	1	4413-2.00
2.50 mm	57 mm	2,81	1	4413-2.50
3.00 mm	61 mm	2,85	1	4413-3.00
3.25 mm	65 mm	2,85	1	4413-3.25
3.30 mm	65 mm	2,85	1	4413-3.30
3.50 mm	70 mm	2,85	1	4413-3.50
4.00 mm	75 mm	3,06	1	4413-4.00
4.20 mm	75 mm	1,91	1	4413-4.20
4.25 mm	75 mm	1,91	1	4413-4.25
4.50 mm	80 mm	2,01	1	4413-4.50
5.00 mm	86 mm	2,17	1	4413-5.00
5.50 mm	93 mm	2,99	1	4413-5.50
6.00 mm	93 mm	2,99	1	4413-6.00
6.50 mm	101 mm	3,49	1	4413-6.50
6.80 mm	109 mm	3,93	1	4413-6.80
7.00 mm	109 mm	4,10	1	4413-7.00
7.50 mm	109 mm	4,40	1	4413-7.50
8.00 mm	117 mm	4,68	1	4413-8.00
8.50 mm	117 mm	5,08	1	4413-8.50
9.00 mm	125 mm	6,46	1	4413-9.00
9.50 mm	125 mm	5,99	1	4413-9.50
10.00 mm	133 mm	6,13	1	4413-10.00
10.20 mm	133 mm	7,87	1	4413-10.20
10.50 mm	133 mm	8,19	25	4413-10.50
11.00 mm	142 mm	9,01	1	4413-11.00
11.50 mm	142 mm	9,76	25	4413-11.50
12.00 mm	151 mm	10,65	1	4413-12.00
12.50 mm	151 mm	11,62	25	4413-12.50
13.00 mm	151 mm	12,18	1	4413-13.00

## Broca para metal HSS-G



### 4513

Ø	L	€		
1.00 mm	34 mm	17,81	1	4513-1.00-10P
1.50 mm	40 mm	13,28	1	4513-1.50-10P
1.75 mm	46 mm	14,78	1	4513-1.75-10P
2.00 mm	49 mm	12,51	1	4513-2.00-10P
2.50 mm	57 mm	12,84	1	4513-2.50-10P
2.70 mm	61 mm	15,54	1	4513-2.70-10P
2.90 mm	61 mm	15,54	1	4513-2.90-10P
3.00 mm	61 mm	11,33	1	4513-3.00-10P
3.10 mm	65 mm	13,28	1	4513-3.10-10P
3.25 mm	65 mm	13,28	1	4513-3.25-10P
3.30 mm	65 mm	13,28	1	4513-3.30-10P
3.50 mm	70 mm	13,28	1	4513-3.50-10P
3.80 mm	75 mm	18,88	1	4513-3.80-10P
4.00 mm	75 mm	16,83	1	4513-4.00-10P
4.20 mm	75 mm	18,56	1	4513-4.20-10P
4.50 mm	80 mm	19,42	1	4513-4.50-10P
4.80 mm	86 mm	21,26	1	4513-4.80-10P
5.00 mm	86 mm	21,31	1	4513-5.00-10P

Ø	L	€		
5.20 mm	86 mm	23,74	1	4513-5.20-10P
5.50 mm	93 mm	27,61	1	4513-5.50-10P
6.00 mm	93 mm	28,48	1	4513-6.00-10P
6.20 mm	101 mm	32,36	1	4513-6.20-10P
6.50 mm	101 mm	33,23	1	4513-6.50-10P
6.80 mm	109 mm	37,98	1	4513-6.80-10P
7.00 mm	109 mm	40,14	1	4513-7.00-10P
7.20 mm	109 mm	50,71	1	4513-7.20-10P
7.50 mm	109 mm	42,72	1	4513-7.50-10P
7.80 mm	117 mm	62,07	1	4513-7.80-10P
8.00 mm	117 mm	48,34	1	4513-8.00-10P
8.50 mm	117 mm	52,64	1	4513-8.50-10P
8.60 mm	125 mm	83,39	1	4513-8.60-10P
8.80 mm	125 mm	85,16	1	4513-8.80-10P
9.00 mm	125 mm	63,86	1	4513-9.00-10P
9.20 mm	125 mm	86,56	1	4513-9.20-10P
9.50 mm	125 mm	61,55	1	4513-9.50-10P
9.60 mm	133 mm	97,86	1	4513-9.60-10P
10.00 mm	133 mm	31,03	1	4513-10.00-5P
10.20 mm	133 mm	39,04	1	4513-10.20-5P
10.30 mm	133 mm	49,50	1	4513-10.30-5P
10.50 mm	133 mm	40,61	1	4513-10.50-5P
10.80 mm	142 mm	61,06	1	4513-10.80-5P
11.00 mm	142 mm	44,36	1	4513-11.00-5P
11.50 mm	142 mm	48,54	1	4513-11.50-5P
12.00 mm	151 mm	52,99	1	4513-12.00-5P
12.50 mm	151 mm	58,00	1	4513-12.50-5P
12.80 mm	151 mm	101,54	1	4513-12.80-5P
13.50 mm	160 mm	20,93	1	4513-13.50-1P
14.00 mm	160 mm	22,53	1	4513-14.00-1P
14.50 mm	169 mm	24,16	1	4513-14.50-1P
15.00 mm	169 mm	24,47	1	4513-15.00-1P
15.50 mm	178 mm	27,96	1	4513-15.50-1P
16.00 mm	178 mm	29,81	1	4513-16.00-1P
16.50 mm	184 mm	32,97	1	4513-16.50-1P
17.00 mm	184 mm	32,97	1	4513-17.00-1P
17.50 mm	191 mm	37,95	1	4513-17.50-1P
18.00 mm	191 mm	40,14	1	4513-18.00-1P
18.50 mm	198 mm	44,54	1	4513-18.50-1P
19.00 mm	198 mm	44,54	1	4513-19.00-1P
19.50 mm	205 mm	47,78	1	4513-19.50-1P

## Juego de 6 brocas para metal



### 4513-SET-6

X	g	€		
6	150 g	16,37	1	4513-SET-6

2.0 a 8.0 mm x 1.0 mm (excl. 7.0 mm) en un soporte de plástico

4413-2.00, 4413-3.00, 4413-4.00, 4413-5.00, 4413-6.00, 4413-8.00

## Juego de 19 brocas para metal



### 4513-SET-19

X	g	€		
19	600 g	58,82	1	4513-SET-19

4413-1.00, 4413-1.50, 4413-2.00, 4413-2.50, 4413-3.00, 4413-3.50, 4413-4.00, 4413-4.50, 4413-5.00, 4413-5.50, 4413-6.00, 4413-6.50, 4413-7.00, 4413-7.50, 4413-8.00, 4413-8.50, 4413-9.00, 4413-9.50, 4413-10.00

## Juego de 25 brocas para metal



### 4513-SET-25

X	g	€		
25	1200 g	125,47	1	4513-SET-25

1x 1.0, 1.5; 2.0; 2.5; 3.0; 3.5; 4.0; 4.5; 5.0; 5.5; 6.0; 6.5; 7.0; 7.5; 8.0; 8.5; 9.0; 9.5; 10.0; 10.5; 11.0; 11.5; 12; 12.5; 13.0 mm1pc 13.0mm



Broca para metal HSS-R



**4415**



Ø	L	€	Icon	Icon
1.00 mm	34 mm	0,94	1	4415-1.00
1.50 mm	40 mm	0,94	1	4415-1.50
2.00 mm	49 mm	0,94	1	4415-2.00
2.50 mm	57 mm	0,94	1	4415-2.50
3.00 mm	61 mm	0,94	1	4415-3.00
3.25 mm	65 mm	1,07	1	4415-3.25
3.50 mm	70 mm	1,15	1	4415-3.50
4.00 mm	75 mm	1,15	1	4415-4.00
4.25 mm	75 mm	0,78	1	4415-4.25
4.50 mm	80 mm	0,85	1	4415-4.50
5.00 mm	86 mm	0,85	1	4415-5.00
5.50 mm	93 mm	0,94	1	4415-5.50
6.00 mm	93 mm	0,98	1	4415-6.00
6.50 mm	101 mm	1,07	1	4415-6.50
7.00 mm	109 mm	1,15	1	4415-7.00
7.50 mm	109 mm	1,35	1	4415-7.50
8.00 mm	117 mm	1,63	1	4415-8.00
8.50 mm	117 mm	1,83	1	4415-8.50
9.00 mm	125 mm	1,94	1	4415-9.00
10.00 mm	125 mm	2,28	1	4415-10.00
10.50 mm	133 mm	2,47	1	4415-10.50
11.00 mm	142 mm	3,02	1	4415-11.00
11.50 mm	142 mm	3,24	1	4415-11.50
12.00 mm	151 mm	3,56	1	4415-12.00
12.50 mm	151 mm	3,79	1	4415-12.50
13.00 mm	151 mm	4,00	1	4415-13.00
13.50 mm	160 mm	5,34	1	4415-13.50
14.00 mm	160 mm	5,72	1	4415-14.00
14.50 mm	169 mm	6,47	1	4415-14.50
15.00 mm	169 mm	6,98	1	4415-15.00
15.50 mm	178 mm	7,75	1	4415-15.50
16.00 mm	178 mm	8,30	1	4415-16.00
16.50 mm	184 mm	8,87	1	4415-16.50
17.00 mm	184 mm	9,38	1	4415-17.00
17.50 mm	191 mm	10,36	1	4415-17.50
18.00 mm	191 mm	10,72	1	4415-18.00
18.50 mm	198 mm	11,67	1	4415-18.50
19.00 mm	198 mm	12,18	1	4415-19.00
19.50 mm	205 mm	12,68	1	4415-19.50
20.00 mm	205 mm	13,32	1	4415-20.00

Brocas para metal HSS-R Drill , embalaje industrial



**4515**

Ø	L	€	Icon	Icon
1.00 mm	34 mm	3,77	1	4515-1.00-10P
1.50 mm	40 mm	3,77	1	4515-1.50-10P
2.00 mm	49 mm	3,77	1	4515-2.00-10P
2.50 mm	57 mm	3,77	1	4515-2.50-10P
3.00 mm	61 mm	3,77	1	4515-3.00-10P
3.25 mm	65 mm	5,18	1	4515-3.25-10P
3.50 mm	70 mm	5,64	1	4515-3.50-10P
4.00 mm	75 mm	5,64	1	4515-4.00-10P
4.25 mm	75 mm	6,97	1	4515-4.25-10P
4.50 mm	80 mm	6,97	1	4515-4.50-10P
5.00 mm	86 mm	7,47	1	4515-5.00-10P

Ø	L	€	Icon	Icon
5.50 mm	93 mm	8,47	1	4515-5.50-10P
6.00 mm	93 mm	8,96	1	4515-6.00-10P
6.50 mm	101 mm	9,46	1	4515-6.50-10P
7.00 mm	109 mm	13,08	1	4515-7.00-10P
7.50 mm	109 mm	14,43	1	4515-7.50-10P
8.00 mm	117 mm	15,44	1	4515-8.00-10P
8.50 mm	117 mm	18,88	1	4515-8.50-10P
9.00 mm	125 mm	21,20	1	4515-9.00-10P
9.50 mm	125 mm	23,55	1	4515-9.50-10P
10.00 mm	133 mm	23,74	1	4515-10.00-10P
10.50 mm	133 mm	13,08	1	4515-10.50-5P
11.00 mm	142 mm	15,26	1	4515-11.00-5P
11.50 mm	142 mm	16,24	1	4515-11.50-5P
12.00 mm	151 mm	16,72	1	4515-12.00-5P
12.50 mm	151 mm	17,90	1	4515-12.50-5P
13.00 mm	151 mm	19,09	1	4515-13.00-5P

Juego de 19 brocas para metal



**4515-SET-19**



Icon	Icon	€	Icon	Icon
X	g	23,30	1	4515-SET-19

1pc 10.0mm

Brocas para metal HSS-R Drill , 25 piezas



**4515-SET-25**



Icon	Icon	€	Icon	Icon
X	g	45,54	1	4515-SET-25

1x 1.0; 1.5; 2.0; 2.5; 3.0; 3.5; 4.0; 4.5; 5.0; 5.5; 6.0; 6.5; 7; 7.5; 8; 8.5; 9.0; 9.5; 10; 10.5; 11; 11.5; 12; 12.5; 13 mm

Broca escalonada de 4 a 12 mm



**228-SD**

Icon	Icon	€	Icon	Icon
6.35 mm	4-5-6-7-8-9-10-11-12 mm	24,39	24	228-SD

Broca escalonada de 4 a 22 mm



**229-SD**

Icon	Icon	€	Icon	Icon
10 mm	4-6-8-10-12-14-16-18-20-22 mm	33,43	24	229-SD

Broca escalonada de 13 niveles



**230-SD**

Icon	Icon	€	Icon	Icon
12.7 mm	5-13-15-17-19-21-23-25-27-29-31-33-35 mm	75,12	25	230-SD





Broca escalonada 6 a 37mm



**232-SD**

Ø	L	€	Icon	Icon
10 mm	6-9-12.5-15.2-18.6-20.4-22.5-26-28.3-30.5-34-37 mm	127,77	1	232-SD

Broca escalonada 6.5 a 40.5mm



**234-SD**

Ø	L	€	Icon	Icon
10 mm	6.5-8.5-10.5-12.5-16.5-20.5-25.5-29-32.5-36.5-40.5 mm	142,95	25	234-SD

Juego brocas escalonadas acero rápido 4-30mm



**228-SET**

Icon	g	€	Icon	Icon
X	560 g	134,18	1	228-SET-SD

228-SD	
229-SD	
230-SD	

Brocas HSS-G para metal



**4435**

Ø	L	€	Icon	Icon
12.4 mm	56 mm	7,84	1	4435-12.4

Brocas de instalador para madera



**9666**

Ø	L	€	Icon	Icon
6 mm	400 mm	11,83	1	9666-6-400
6 mm	600 mm	11,89	1	9666-6-600
8 mm	400 mm	11,83	1	9666-8-400
8 mm	600 mm	11,89	1	9666-8-600
10 mm	400 mm	14,70	1	9666-10-400
10 mm	600 mm	14,89	1	9666-10-600
12 mm	400 mm	17,35	1	9666-12-400
12 mm	600 mm	17,57	1	9666-12-600
14 mm	400 mm	18,74	1	9666-14-400
14 mm	600 mm	19,55	1	9666-14-600
16 mm	400 mm	21,96	1	9666-16-400
16 mm	600 mm	23,24	1	9666-16-600
20 mm	400 mm	32,78	1	9666-20-400
20 mm	600 mm	34,69	1	9666-20-600
22 mm	400 mm	40,37	1	9666-22-400
22 mm	600 mm	41,96	1	9666-22-600

Broca helicoidal para madera



**9626**

Ø	€	Icon	Icon
6.0 mm	15,14	1	9626-6
7.0 mm	15,56	1	9626-7
8.0 mm	15,94	1	9626-8
9.0 mm	16,55	1	9626-9
10.0 mm	16,92	1	9626-10
11.0 mm	17,21	1	9626-11
12.0 mm	17,59	1	9626-12
13.0 mm	18,05	1	9626-13
14.0 mm	18,59	1	9626-14
15.0 mm	19,42	1	9626-15
16.0 mm	21,29	1	9626-16
18.0 mm	27,17	1	9626-18
20.0 mm	30,80	1	9626-20
22.0 mm	34,42	1	9626-22
23.0 mm	36,09	1	9626-23
24.0 mm	37,73	1	9626-24
25.0 mm	39,46	1	9626-25
26.0 mm	41,18	1	9626-26
28.0 mm	48,61	1	9626-28
30.0 mm	69,59	1	9626-30
32.0 mm	69,59	1	9626-32
35.0 mm	69,59	1	9626-35
6.0 mm	25,99	1	9627-6-460
8.0 mm	26,35	1	9627-8-460
10.0 mm	26,69	1	9627-10-460
12.0 mm	27,03	1	9627-12-460
14.0 mm	29,11	1	9627-14-460
16.0 mm	30,49	1	9627-16-460
18.0 mm	35,35	1	9627-18-460
20.0 mm	39,85	1	9627-20-460
22.0 mm	41,58	1	9627-22-460
24.0 mm	45,06	1	9627-24-460
26.0 mm	48,51	1	9627-26-460
28.0 mm	50,24	1	9627-28-460
30.0 mm	61,49	1	9627-30-460
32.0 mm	69,30	1	9627-32-460

Juego 6 brocas helicoidales



**SB-9526/S6**

Icon	€	Icon	Icon
X	48,44	20	SB-9526/S6

9526-10, 9526-13, 9526-19, 9526-22, 9526-25  
9526-16

## Brocas planas para madera



### 9629

Ø	L	€	X	g
6.0 mm	152 mm	7,28	1	9629-6
8.0 mm	152 mm	5,44	1	9629-8
10.0 mm	152 mm	6,19	1	9629-10
12.0 mm	152 mm	6,19	1	9629-12
13.0 mm	152 mm	5,87	1	9629-13
14.0 mm	152 mm	6,57	1	9629-14
16.0 mm	152 mm	6,57	1	9629-16
17.0 mm	152 mm	6,57	1	9629-17
18.0 mm	152 mm	6,57	1	9629-18
19.0 mm	152 mm	6,57	1	9629-19
20.0 mm	152 mm	7,16	1	9629-20
22.0 mm	152 mm	7,16	1	9629-22
24.0 mm	152 mm	7,16	1	9629-24
25.0 mm	152 mm	7,16	1	9629-25
26.0 mm	152 mm	6,79	1	9629-26
28.0 mm	152 mm	11,18	1	9629-28
30.0 mm	152 mm	11,22	1	9629-30
32.0 mm	152 mm	11,27	1	9629-32
35.0 mm	152 mm	11,07	1	9629-35
36.0 mm	152 mm	11,99	1	9629-36
38.0 mm	152 mm	13,16	1	9629-38
40.0 mm	152 mm	13,16	1	9629-40
6.0 mm	400 mm	9,96	1	9631-6-400
8.0 mm	400 mm	9,96	1	9631-8-400
10.0 mm	400 mm	10,48	1	9631-10-400
12.0 mm	400 mm	11,62	1	9631-12-400
13.0 mm	400 mm	9,06	1	9631-13-400
14.0 mm	400 mm	9,93	1	9631-14-400
16.0 mm	400 mm	10,94	1	9631-16-400
18.0 mm	400 mm	12,33	1	9631-18-400
19.0 mm	400 mm	11,17	1	9631-19-400
20.0 mm	400 mm	12,33	1	9631-20-400
22.0 mm	400 mm	14,27	1	9631-22-400
24.0 mm	400 mm	15,32	1	9631-24-400
25.0 mm	400 mm	14,94	1	9631-25-400
28.0 mm	400 mm	18,58	1	9631-28-400
30.0 mm	400 mm	19,67	1	9631-30-400
32.0 mm	400 mm	22,27	1	9631-32-400
35.0 mm	400 mm	20,28	1	9631-35-400
38.0 mm	400 mm	20,42	1	9631-38-400

## Juego de 8 brocas planas para madera



### 9629-SET-8

X	g	€	X	g
8	630 g	31,73	12	9629-SET-8

9629-12, 9629-16, 9629-18, 9629-20, 9629-22,  
9629-25, 9629-28, 9629-32

## Juego de brocas de punta perforadora para madera, 6 piezas



### 9656-SET-6

X	g	€	X	g
6	720 g	67,27	1	9656-SET-6

## Broca helicoidal para madera



### 9646

Ø	€	X	g
3 mm	3,56	1	9646-3
4 mm	3,92	1	9646-4
5 mm	4,27	1	9646-5
6 mm	4,64	1	9646-6
7 mm	5,00	1	9646-7
8 mm	5,72	1	9646-8
9 mm	6,25	1	9646-9
10 mm	6,78	1	9646-10
11 mm	7,84	1	9646-11
12 mm	9,99	1	9646-12
13 mm	10,68	1	9646-13
14 mm	12,47	1	9646-14
15 mm	13,20	1	9646-15
16 mm	13,20	1	9646-16
18 mm	19,63	1	9646-18
20 mm	19,63	1	9646-20
6 mm	5,17	1	9646-6-250
8 mm	6,25	1	9646-8-250
10 mm	7,30	1	9646-10-250
12 mm	10,54	1	9646-12-250

## Juego de 5 brocas para madera



### 9646-SET-5

X	g	€	X	g
5	110 g	10,96	1	9646-SET-5

9646-4, 9646-5, 9646-6, 9646-8, 9646-10

## Juego de 8 brocas para madera



### 9646-SET-8

X	g	€	X	g
8	230 g	14,21	1	9646-SET-8

9646-3, 9646-4, 9646-5, 9646-6, 9646-7, 9646-8,  
9646-9, 9646-10

## Brocas para azulejos



### 4626

Ø	L	€	X	g
4 mm	58 mm	5,71	1	4626-4.0
5 mm	58 mm	6,28	1	4626-5.0
6 mm	58 mm	6,59	1	4626-6.0
8 mm	78 mm	7,87	1	4626-8.0
10 mm	98 mm	9,53	1	4626-10.0



Brocas multiusos



**4629**

Ø	L	€	Icon	Icon
4.0 mm	75 mm	5,46	1	4629-4.0
5.0 mm	85 mm	5,72	1	4629-5.0
6.0 mm	100 mm	6,34	1	4629-6.0
8.0 mm	120 mm	7,62	1	4629-8.0
10.0 mm	120 mm	8,50	1	4629-10.0

Juego de 5 brocas para multiusos con punta de carburo



**4629-SET-5**

Icon	g	€	Icon	Icon
5	165 g	36,62	10	4629-SET-5

4629-8.0, 4629-10.0, 4629-4.0, 4629-5.0, 4629-6.0

Extensión 305mm cambio rápido



**9625-6.35QC**

Ø	L	€	Icon	Icon
6.35 mm	305 mm	27,92	1	9625-6.35QC

Extensión de 330 mm para brocas de 3 puntas



**9525**

Icon	€	Icon	Icon
7 mm	15,06	1	9525-7
10 mm	19,16	1	9525-10

**PUNTAS DESTORNILLADOR**

Punta diamante Phillips - 25 mm



**63D/PH**

Icon	Icon	€	Icon	Icon
5	3	17,39	1	63D/PH3

Punta diamante Pozidriv - 25 mm



**63D/PZ**

Icon	Icon	€	Icon	Icon
5	1	17,39	1	63D/PZ1
5	2	17,39	1	63D/PZ2

Punta diamante Torx - 25 mm



**63D/T**

Icon	Icon	€	Icon	Icon
5	T10	19,88	1	63D/T10
5	T15	19,88	1	63D/T15
5	T40	19,88	1	63D/T40

Caja 5 Puntas Pozidriv de diamante, 50 mm



**63D/50PZ**

Icon	Icon	€	Icon	Icon
5	1	27,33	1	63D/50PZ1
5	2	27,33	1	63D/50PZ2
5	3	27,33	1	63D/50PZ3

Juego de 6 puntas de diamante Phillips, Pozidriv, TORX® y adaptador



**63D/7**

Icon	Icon	€	Icon	Icon
7	20 x 50 x 80 mm	29,72	1	63D/7-1

**63D/PH2**

**63D/PZ2**

**63D/T10, 63D/T15, 63D/T25, 63D/T30**

Punta de torsión TIN Phillips - 25 mm



**62TIN/PH**

X	+	€		
10	1	21,13	1	62TIN/PH1

Punta de torsión TIN Phillips - 50 mm



**62TIN/50PH**

X	+	€		
5	1	22,97	1	62TIN/50PH1
5	3	22,97	1	62TIN/50PH3

Punta de torsión Phillips ACR - 25 mm



**64A/PH**

X	+	€		
10	1	15,40	1	64A/PH1
10	3	15,40	1	64A/PH3

Punta de torsión TIN Pozidriv - 25 mm



**62TIN/PZ**

X	+	€		
10	1	21,13	1	62TIN/PZ1
10	2	21,13	1	62TIN/PZ2
10	3	21,13	1	62TIN/PZ3

Punta de torsión TIN Pozidriv - 50 mm



**62TIN/50PZ**

X	+	€		
5	1	22,97	1	62TIN/50PZ1
5	2	22,97	1	62TIN/50PZ2
5	3	22,97	1	62TIN/50PZ3

Punta de torsión Pozidriv ACR - 25 mm



**64A/PZ**

X	+	€		
10	1	15,40	1	64A/PZ1
10	3	15,40	1	64A/PZ3

Punta de torsión TIN Torx - 25 mm



**62TIN/T**

X	+	€		
10	T15	26,08	1	62TIN/T15
10	T20	26,08	1	62TIN/T20
10	T25	26,08	1	62TIN/T25
10	T30	26,08	1	62TIN/T30

Juego de 6 puntas TIN Phillips, Pozidriv, TORX®



**62TIN/7**

X		€		
7	22 x 65 x 75 mm	23,64	1	62TIN/7-1

62TIN/PH2				
62TIN/PZ2				
62TIN/T15, 62TIN/T20, 62TIN/T25, 62TIN/T30				

Punta de torsión Phillips - 25 mm



**60T/PH**

X	+	€		
10	1	11,19	1	60T/PH1
10	2	11,19	1	60T/PH2
10	3	11,19	1	60T/PH3



Punta de torsión Pozidriv - 25 mm



**60T/PZ**

		€		
10	3	11,19	1	60T/PZ3



Juego de 17 puntas de torsión Phillips, Pozidriv, TORX® y adaptador magnético



**60T/17**

		€		
17	27 x 73 x 82 mm	29,75	1	60T/17-1



Punta de torsión Pozidriv extra dura - 25 mm



**61H/PZ**

		€		
5	3	5,96	1	61H/PZ3



Punta de torsión Torx - 25 mm



**60T/T**

		€		
10	T7	17,39	1	60T/T7
10	T9	17,39	1	60T/T9
10	T15	17,39	1	60T/T15
10	T20	17,39	1	60T/T20
10	T25	17,39	1	60T/T25
10	T27	17,39	1	60T/T27
10	T40	17,39	1	60T/T40



Punta de torsión Phillips extra dura - 25 mm



**61H/PH**

		€		
10	2	11,93	1	61H/PH2
5	3	5,96	1	61H/PH3



Punta de torsión Pozidriv extra dura - 50 mm



**61H/50PZ**

		€		
5	1	15,16	1	61H/50PZ1
5	3	15,16	1	61H/50PZ3



Juego de 6 puntas de torsión Phillips, Pozidriv, TORX® y adaptador magnético



**60T/7**

		€		
7	22 x 65 x 75 mm	18,12	1	60T/7-1



Punta de torsión Phillips extra dura - 50 mm



**61H/50PH**

		€		
5	1	15,16	1	61H/50PH1



Punta de torsión Torx extra dura - 50 mm



**61H/50T**

		€		
5	T10	19,24	1	61H/50T10
5	T15	19,24	1	61H/50T15
5	T25	19,24	1	61H/50T25





Punta de torsión Torx extra dura - 25 mm



61H/T

X	Icon	€	Icon	Icon
10	T10	18,36	1	61H/T10
10	T15	18,36	1	61H/T15
10	T20	18,36	1	61H/T20
10	T25	18,36	1	61H/T25
5	T40	9,20	1	61H/T40

Puntas de impacto 1/4" 25mm, Torx



66IM/T

X	Icon	€	Icon	Icon
10	T10	9,26	50	66IM/T10C-10P
10	T15	9,26	50	66IM/T15C-10P
10	T20	9,26	50	66IM/T20C-10P
25	T20	16,47	25	66IM/T20C-25P
10	T25	9,26	50	66IM/T25C-10P
25	T25	16,47	25	66IM/T25C-25P
10	T27	9,26	50	66IM/T27C-10P
10	T30	9,26	50	66IM/T30C-10P
25	T30	16,47	25	66IM/T30C-25P
10	T40	9,26	50	66IM/T40C-10P
2	T10	3,23	80	66IM/T10C-2P
2	T15	3,23	80	66IM/T15C-2P
2	T20	3,23	80	66IM/T20C-2P
2	T25	3,23	80	66IM/T25C-2P
2	T27	3,23	80	66IM/T27C-2P
2	T20	3,23	80	66IM/T30C-2P
2	T40	3,23	80	66IM/T40C-2P

Puntas de impacto 1/4" 50mm, Pozidriv



66IM/50PZ

X	Icon	€	Icon	Icon
10	1	15,44	50	66IM/50PZ1-10P
10	2	15,44	50	66IM/50PZ2-10P
10	3	15,44	50	66IM/50PZ3-10P
2	1	4,00	80	66IM/50PZ1-2P
2	2	4,00	80	66IM/50PZ2-2P
2	3	4,00	80	66IM/50PZ3-2P

Puntas de impacto 1/4" 25mm, Phillips



66IM/PH

X	Icon	€	Icon	Icon
10	1	9,26	50	66IM/PH1-10P
10	2	9,26	50	66IM/PH2-10P
25	2	16,47	25	66IM/PH2-25P
10	3	9,26	50	66IM/PH3-10P
2	1	3,14	80	66IM/PH1-2P
2	2	3,14	80	66IM/PH2-2P
2	3	3,14	80	66IM/PH3-2P

Puntas de impacto 1/4" 50mm, Phillips



66IM/50PH

X	Icon	€	Icon	Icon
10	1	15,44	50	66IM/50PH1-10P
10	2	15,44	50	66IM/50PH2-10P
10	3	15,44	50	66IM/50PH3-10P
2	1	4,00	80	66IM/50PH1-2P
2	2	4,00	80	66IM/50PH2-2P
2	3	4,00	80	66IM/50PH3-2P

Puntas de impacto 1/4" 25mm, Pozidriv



66IM/PZ

X	Icon	€	Icon	Icon
10	1	9,26	50	66IM/PZ1-10P
10	2	9,26	50	66IM/PZ2-10P
25	2	16,47	25	66IM/PZ2-25P
10	3	9,26	50	66IM/PZ3-10P
2	1	3,14	80	66IM/PZ1-2P
2	2	3,14	80	66IM/PZ2-2P
2	3	3,14	80	66IM/PZ3-2P

Puntas de impacto 1/4" 50mm, Torx



66IM/50TC

X	Icon	€	Icon	Icon
10	T10	15,44	50	66IM/50T10C-10P
10	T15	15,44	50	66IM/50T15C-10P
10	T20	15,44	50	66IM/50T20C-10P
10	T25	15,44	50	66IM/50T25C-10P
10	T27	15,44	50	66IM/50T27C-10P
10	T30	15,44	50	66IM/50T30C-10P
10	T40	15,44	50	66IM/50T40C-10P
2	10	4,05	80	66IM/50T10C-2P
2	15	4,05	80	66IM/50T15C-2P
2	20	4,05	80	66IM/50T20C-2P
2	25	4,05	80	66IM/50T25C-2P
2	27	4,05	80	66IM/50T27C-2P
2	30	4,05	80	66IM/50T30C-2P
2	40	4,05	80	66IM/50T40C-2P



1/4" Puntas de torsión de impacto y de 1/4" para tornillos Phillips 90 mm



### 66IM/90PH

X	+	€		
2	2	5,14	40	66IM/90PH2-2P
2	3	5,14	40	66IM/90PH3-2P

1/4" Puntas de torsión de impacto y de 1/4" para tornillos Phillips 150 mm



### 66IM/150PH

X	+	€		
2	2	7,20	40	66IM/150PH2-2P

Llaves de vaso magnéticas de cabeza hexagonal de 1/4" de impacto



### 66IM/M50

X	€		
1	7,20	20	66IM/M50-6-1P
1	7,20	20	66IM/M50-7-1P
1	7,20	20	66IM/M50-8-1P
1	7,20	20	66IM/M50-10-1P
1	7,20	20	66IM/M50-11-1P
1	8,23	20	66IM/M50-13-1P

1/4" Puntas de torsión de impacto y de 1/4" para tornillos Pozidriv 90 mm



### 66IM/90PZ

X	+	€		
2	2	5,14	40	66IM/90PZ2-2P
2	3	5,14	40	66IM/90PZ3-2P

1/4" Puntas de torsión de impacto y de 1/4" para tornillos Pozidriv 150 mm



### 66IM/150PZ

X	+	€		
2	2	7,20	40	66IM/150PZ2-2P

Portapuntas magnético universal hexagonal para puntas de 1/4" de impacto



### 66IM/KM

X	€		
1	13,38	20	66IM/KM150-1P
1	16,47	20	66IM/KM300-1P
1	8,23	20	66IM/KM75-1P

Puntas de torsión de impacto y de 1/4" para tornillos de cabeza TORX® 90 mm



### 66IM/90TC

X	T	€		
2	T15	5,14	40	66IM/90T15C-2P
2	T20	5,14	40	66IM/90T20C-2P
2	T25	5,14	40	66IM/90T25C-2P
2	T30	5,14	40	66IM/90T30C-2P
2	T40	5,14	40	66IM/90T40C-2P

Puntas de torsión de impacto y de 1/4" para tornillos de cabeza TORX® 150 mm



### 66IM/150TC

X	T	€		
2	T20	7,20	40	66IM/150T20C-2P
2	T25	7,20	40	66IM/150T25C-2P
2	T30	7,20	40	66IM/150T30C-2P
2	T40	7,20	40	66IM/150T40C-2P

Portapuntas magnético universal hexagonal de impacto de 1/4" con liberación rápida



### 66IM/KMQR

X	€		
1	13,38	20	66IM/KM75QR-1P

Puntas de torsión de impacto de 1/4" para adaptador 1/4", 3/8", 1/2", 50 mm



### 66IM/K

	€			
1	9,26	20	66IM/K50-1/2-1P	
1	9,26	20	66IM/K50-1/4-1P	
1	9,26	20	66IM/K50-3/8-1P	

Juego de 11 puntas de impacto de 25mm



### 66IM/11C-1

	€			
11	18,21	40	66IM/11C-1	

66IM/PH2-2Px 2, 66IM/PH3-2P				
66IM/PZ2-2Px 2, 66IM/PZ3-2P				
66IM/T20C-2Px 2, 66IM/T25C-2P, 66IM/T30C-2P				
KMT753-QR-1P				

Juego de 10 puntas de impacto 50mm



### 66IM/10C-1

	€			
10	22,77	40	66IM/10C-1	

66IM/50PH2-2Px 2, 66IM/50PH3-2P				
66IM/50PZ2-2Px 2, 66IM/50PZ3-2P				
66IM/50T20C-2Px 2, 66IM/50T25C-2P, 66IM/50T30C-2P				

Juego de puntas de torsión de impacto de 1/4" para tornillos ranurados/ Phillips/ Pozidriv/TORX®/He- 31 piezas



### 66IM/31C-1

	€			
31	29,27	6	66IM/31C-1	

66IM/PH1-2P, 66IM/PH2-2Px 3, 66IM/PH3-2P				
66IM/PZ1-2P, 66IM/PZ2-2Px 3, 66IM/PZ3-2P				
66IM/T10C-2P, 66IM/T15C-2Px 3, 66IM/T20C-2Px 3, 66IM/T25C-2Px 2, 66IM/T27C-2P, 66IM/T30C-2Px 2				
66IM/KM75QR-1P				

Juego de puntas de torsión de impacto de 1/4" para tornillos Phillips/Pozidriv/TORX®/ Cabeza hexagonal - 40 piezas



### 66IM/40C-1

	€			
40	91,67	10	66IM/40C-1	

66IM/PZ2-2P				
66IM/T10C-2P, 66IM/T15C-2P, 66IM/T20C-2P, 66IM/T25C-2P, 66IM/T30C-2P				
66IM/50PH1-2P, 66IM/50PH2-2P, 66IM/50PH3-2P				
66IM/50PZ1-2P, 66IM/50PZ2-2P, 66IM/50PZ3-2P				
66IM/50T10C-2P, 66IM/50T15C-2P, 66IM/50T20C-2P, 66IM/50T25C-2P, 66IM/50T27C-2P, 66IM/50T30C-2P, 66IM/50T40C-2P				
66IM/90T15C-2P, 66IM/90T20C-2P, 66IM/90T25C-2P, 66IM/90T30C-2P, 66IM/90T40C-2P				
66IM/KM75QR-1P				
66IM/K50-1/4-1P				
66IM/M50-8-1P, 66IM/M50-10-1P, 66IM/M50-11-1P, 66IM/M50-13-1P				

Punta estándar ranurada - 25 mm



### 59S/

		€		
3	3.0 mm	3,92	50	59S/0.5-3.0-3P
10	4.0 mm	13,06	1	59S/0.5-4.0
3	4.0 mm	3,92	50	59S/0.5-4.0-3P
10	3.5 mm	13,06	1	59S/0.6-3.5
3	3.5 mm	3,92	50	59S/0.6-3.5-3P
10	4.5 mm	13,06	1	59S/0.6-4.5
3	4.5 mm	3,92	1	59S/0.6-4.5-3P
10	5.5 mm	13,06	1	59S/0.8-5.5
3	5.5 mm	3,92	1	59S/0.8-5.5-3P
10	5.5 mm	13,06	1	59S/1.0-5.5
3	5.5 mm	3,92	50	59S/1.0-5.5-3P
10	6.5 mm	13,06	1	59S/1.2-6.5
3	6.5 mm	3,92	50	59S/1.2-6.5-3P
10	8.0 mm	21,22	1	59S/1.2-8.0
3	8.0 mm	6,38	1	59S/1.2-8.0-3P
10	9.0 mm	21,22	1	59S/1.6-9.0
10	10 mm	21,22	1	59S/1.6-10
3	9.0 mm	6,38	50	59S/1.6-9.0-3P
3	10.0 mm	6,38	50	59S/1.6-10-3P

Punta estándar Phillips - 25 mm



### 59S/PH

		€		
10	0	6,82	1	59S/PH0
3	0	2,62	50	59S/PH0-3P
10	1	6,82	50	59S/PH1-10P
3	1	3,41	1	59S/PH1-3P
30	1	19,12	1	59S/PH1-30P
100	*1	0,54	100	59S/PH1-IP
500	1	0,48	500	59S/PH1-IPB
10	2	6,82	50	59S/PH2-10P
3	2	3,41	1	59S/PH2-3P
30	2	19,12	1	59S/PH2-30P
100	*2	0,54	100	59S/PH2-IP
500	*2	0,48	500	59S/PH2-IPB
10	3	6,82	50	59S/PH3-10P
3	3	3,41	1	59S/PH3-3P
30	3	19,12	1	59S/PH3-30P
500	3	0,48	500	59S/PH3-IPB
10	4	13,85	1	59S/PH4
3	4	4,45	25	59S/PH4-3P



Punta estándar Grabber Phillips - 25 mm



59S/PH2G

		€		
10	2G	13,35	50	59S/PH2G-10P
3	PH2G	4,00	50	59S/PH2G-3P
30	PH2G	36,50	1	59S/PH2G-30P

Punta estándar Pozidriv - 25 mm



59S/PZ

		€		
3	0	2,62	50	59S/PZ0-3P
10	1	6,82	50	59S/PZ1-10P
3	1	3,41	1	59S/PZ1-3P
30	1	19,12	1	59S/PZ1-30P
100	*1	0,63	100	59S/PZ1-1P
500	*1	0,48	500	59S/PZ1-1PB
10	2	6,82	50	59S/PZ2-10P
3	2	3,41	1	59S/PZ2-3P
30	2	19,12	1	59S/PZ2-30P
100	*2	0,54	100	59S/PZ2-1P
500	*2	0,48	500	59S/PZ2-1PB
10	3	6,82	50	59S/PZ3-10P
3	3	3,41	1	59S/PZ3-3P
30	3	19,12	1	59S/PZ3-30P
500	3	0,48	500	59S/PZ3-1PB
10	4	13,85	1	59S/PZ4

Punta estándar Torx - 25 mm



59S/T

		€		
5	T3	9,54	1	59S/T3
3	T3	5,72	50	59S/T3-3P
3	T4	5,72	50	59S/T4-3P
5	T5	9,54	1	59S/T5
3	T5	5,72	50	59S/T5-3P
3	T6	5,72	50	59S/T6-3P
10	T7	11,44	1	59S/T7
3	T7	5,72	50	59S/T7-3P
10	T8	11,44	1	59S/T8
3	T8	5,72	50	59S/T8-3P
10	T9	11,44	1	59S/T9
3	T9	5,72	50	59S/T9-3P
10	T10	11,43	50	59S/T10-10P
3	T10	5,72	1	59S/T10-3P
30	T10	31,84	1	59S/T10-30P
10	T15	10,30	50	59S/T15-10P
3	T15	5,72	1	59S/T15-3P
30	T15	31,84	1	59S/T15-30P
10	T20	11,43	50	59S/T20-10P
3	T20	5,72	1	59S/T20-3P
30	T20	31,84	1	59S/T20-30P
10	T25	11,43	50	59S/T25-10P
3	T25	5,72	1	59S/T25-3P
30	T25	31,84	1	59S/T25-30P
10	T27	11,43	50	59S/T27-10P
3	T27	5,72	1	59S/T27-3P
10	T30	10,30	50	59S/T30-10P
3	T30	7,65	1	59S/T30-3P
30	T30	35,52	1	59S/T30-30P
10	T40	12,75	50	59S/T40-10P
3	T40	7,65	1	59S/T40-3P
30	T40	35,51	1	59S/T40-30P
5	T45	17,69	50	59S/T45-5P
3	T45	10,62	50	59S/T45-3P
5	T50	17,69	50	59S/T50-5P
3	T50	10,62	50	59S/T50-3P

Puntas 1/4" Torx 25mm, 10 piezas



59S/TCS

		€		
10	T10	9,27	20	59S/T10CS
10	T15	9,27	20	59S/T15CS
10	T20	9,27	20	59S/T20CS
10	T25	9,27	50	59S/T25CS-10P
10	T27	9,27	20	59S/T27CS
10	T30	30,61	20	59S/T30CS
10	T40	30,61	20	59S/T40CS

Punta estándar Torx Tamper - 25 mm



59S/TR

		€		
5	TR 7	14,03	1	59S/TR7
3	TR7	8,42	50	59S/TR7-3P
5	TR 8	14,03	1	59S/TR8
3	TR8	8,42	50	59S/TR8-3P
5	TR 9	14,03	1	59S/TR9
3	TR9	8,42	50	59S/TR9-3P
5	TR 10	14,03	50	59S/TR10-5P
3	TR 10	8,42	1	59S/TR10-3P
5	TR 15	14,03	1	59S/TR15
3	TR 15	8,42	1	59S/TR15-3P
5	TR 20	14,03	50	59S/TR20-5P
3	TR 20	8,42	1	59S/TR20-3P
5	TR 25	14,03	50	59S/TR25-5P
3	TR 25	8,42	1	59S/TR25-3P
5	TR 27	14,03	1	59S/TR27
3	TR 27	8,42	1	59S/TR27-3P
5	TR 30	14,03	50	59S/TR30-5P
3	TR 30	8,42	1	59S/TR30-3P
5	TR 40	14,03	1	59S/TR40
3	TR 40	8,42	1	59S/TR40-3P

Punta estándar hexagonal métrica - 25 mm



59S/H mm

		€		
5	1.5	13,59	50	59S/H1.5-5P
3	1.5	8,17	50	59S/H1.5-3P
5	2	13,59	1	59S/H2
3	2	8,17	50	59S/H2-3P
5	2.5	13,59	50	59S/H2.5-5P
3	2.5	8,17	50	59S/H2.5-3P
5	3	13,59	50	59S/H3-5P
3	3	9,82	1	59S/H3-3P
5	4	13,59	50	59S/H4-5P
3	4	9,82	1	59S/H4-3P
500	4	0,64	500	59S/H4-1PB
5	5	13,59	50	59S/H5-5P
3	5	9,82	1	59S/H5-3P
5	6	13,59	50	59S/H6-5P
3	6	9,82	1	59S/H6-3P
5	8	17,69	50	59S/H8-5P
3	8	10,62	1	59S/H8-3P
5	10	17,69	50	59S/H10-5P
3	10	10,62	25	59S/H10-3P



Punta estándar hexagonal Imperial - 25 mm



59S/H "

X	Icon	€	Icon	Icon
5	1/4 in	13,59	50	59S/H1/16-5P
3	1/16 in	8,17	50	59S/H1/16-3P
5	5/64 in	13,59	50	59S/H5/64-5P
3	5/64 in	8,17	50	59S/H5/64-3P
3	3/32 in	8,17	50	59S/H3/32-3P
5	3/32 in	13,59	50	59S/H3/32-5P
3	7/64 in	8,17	50	59S/H7/64-3P
5	7/64 in	13,59	50	59S/H7/64-5P
3	1/8 in	8,17	50	59S/H1/8-3P
5	1/8 in	13,59	50	59S/H1/8-5P
3	5/32 in	8,17	50	59S/H5/32-3P
5	5/32 in	13,59	50	59S/H5/32-5P
5	3/16 in	13,59	50	59S/H3/16-5P
3	7/32 in	8,17	50	59S/H7/32-3P
5	7/32 in	13,59	50	59S/H7/32-5P
3	1/4 in	8,17	50	59S/H1/4-3P
5	1/4 in	13,59	1	59S/H1/4
3	5/16 in	8,17	50	59S/H5/16-3P
3	3/8 in	10,62	25	59S/H3/8-3P
5	5/16 in	13,59	50	59S/H5/16-5P
5	3/8 in	8,17	1	59S/H3/8

Punta estándar Robertson - 25 mm



59S/R

X	Icon	€	Icon	Icon
10	# 1	29,94	1	59S/R1
3	# 1	11,99	1	59S/R1-3P
3	# 2	11,99	1	59S/R2-3P
10	# 3	29,94	1	59S/R3
3	# 3	11,99	1	59S/R3-3P
10	# 4	29,94	1	59S/R4

Caja 5 Puntas TORQ-SET®, 25 mm



59S/TS

X	Icon	€	Icon	Icon
5	0	37,42	1	59S/TS-0
5	1	37,42	1	59S/TS-1
5	4	37,42	50	59S/TS-4-5P
5	5	10,30	50	59S/TS-5-5P
5	6	37,42	50	59S/TS-6-5P
5	8	37,42	50	59S/TS-8-5P
5	10	37,42	50	59S/TS-10-5P

Caja 5 Puntas Tri-Wing, 25 mm



59S/TW

X	Icon	€	Icon	Icon
5	TW 0	34,02	1	59S/TW0
5	TW 1	34,02	1	59S/TW1
5	TW 2	34,02	1	59S/TW2
5	TW 3	34,02	1	59S/TW3
5	TW 4	34,02	1	59S/TW4
5	TW 5	34,02	1	59S/TW5

Punta estándar XZN - 25 mm



59S/M

X	Icon	€	Icon	Icon
10	M3	35,39	1	59S/M3
3	M3	10,62	50	59S/M3-3P
10	M4	35,39	1	59S/M4
3	M4	10,62	50	59S/M4-3P

X	Icon	€	Icon	Icon
10	M5	35,39	1	59S/M5
3	M5	10,62	50	59S/M5-3P
10	M6	35,39	1	59S/M6
3	M6	10,62	50	59S/M6-3P
10	M8	39,46	1	59S/M8
3	M8	11,83	50	59S/M8-3P

Puntas de destornillador estándar de 1/4" para tornillos de cabeza plana de 50 mm



59S/50

X	Icon	€	Icon	Icon
5	3.5 mm	17,69	50	59S/50/0.6-3.5-5P
5	4.0 mm	17,69	50	59S/50/0.8-4.0-5P
5	5.5 mm	17,69	50	59S/50/0.8-5.5-5P
5	6.0 mm	17,69	50	59S/50/1.0-6.0-5P
5	6.5 mm	17,69	50	59S/50/1.2-6.5-5P
2	3.5 mm	7,08	50	59S/50/3.5-2P
2	4.0 mm	7,08	50	59S/50/4.0-2P
2	5.5 mm	7,08	50	59S/50/5.5-2P
2	6.0 mm	7,08	1	59S/50/6.0-2P
2	6.5 mm	7,08	50	59S/50/6.5-2P

Punta estándar Phillips - 50 mm



59S/50PH

X	Icon	€	Icon	Icon
5	1	14,29	50	59S/50PH1-5P
2	1	7,09	1	59S/50PH1-2P
5	2	9,01	50	59S/50PH2-5P
2	2	7,09	1	59S/50PH2-2P
5	3	14,30	50	59S/50PH3-5P
2	3	7,09	1	59S/50PH3-2P





Punta estándar Pozidriv - 50 mm



**59S/50PZ**

X	Icon	€	Icon	Icon
5	1	14,29	50	59S/50PZ1-5P
2	1	7,09	1	59S/50PZ1-2P
5	2	14,30	50	59S/50PZ2-5P
2	2	7,09	1	59S/50PZ2-2P
5	3	14,30	50	59S/50PZ3-5P
2	3	7,09	1	59S/50PZ3-2P

Punta estándar Torx - 50 mm



**59S/50T**

X	Icon	€	Icon	Icon
5	T 8	19,04	1	59S/50T8
2	T 8	10,07	50	59S/50T8-2P
2	T 10	10,07	1	59S/50T10-2P
5	T 10	19,06	50	59S/50T10-5P
5	T 15	19,06	50	59S/50T15-5P
2	T 15	10,07	1	59S/50T15-2P
5	T 20	9,58	50	59S/50T20-5P
2	T 20	10,07	1	59S/50T20-2P
5	T 25	19,06	50	59S/50T25-5P
2	T 25	10,07	1	59S/50T25-2P
5	T 27	19,04	1	59S/50T27
5	T 30	19,06	50	59S/50T30-5P
2	T 30	10,07	1	59S/50T30-2P
5	T 40	19,06	50	59S/50T40-5P
2	T 40	10,07	50	59S/50T40-2P

Punta estándar métrica hexagonal - 50 mm



**59S/50H**

X	Icon	€	Icon	Icon
5	2	21,77	1	59S/50H2
2	2	5,44	50	59S/50H2-2P
5	2.5	9,01	50	59S/50H2.5-5P
2	2.5	5,44	50	59S/50H2.5-2P
5	3	21,78	50	59S/50H3-5P
2	3	5,44	50	59S/50H3-2P
5	4	9,01	50	59S/50H4-5P
2	4	5,44	50	59S/50H4-2P
5	5	9,01	50	59S/50H5-5P
2	5	5,44	50	59S/50H5-2P
5	6	21,78	50	59S/50H6-5P
2	6	5,44	50	59S/50H6-2P
5	8	21,77	50	59S/50H8-5P
2	8	5,44	50	59S/50H8-2P

Puntas de destornillador estándar de 1/4" para tornillo de cabeza hexagonal imperial de 50 mm



**59S/50H "**

X	Icon	€	Icon	Icon
5	1/1 in	21,09	1	59S/50H1/16
5	5/64 in	21,09	1	59S/50H5/64
5	3/32 in	21,09	1	59S/50H3/32
5	7/64 in	21,09	1	59S/50H7/64
5	1/8 in	21,09	1	59S/50H1/8
5	5/32 in	21,09	1	59S/50H5/32
5	3/16 in	21,09	1	59S/50H3/16
5	7/32 in	21,09	1	59S/50H7/32
5	1/4 in	21,09	1	59S/50H1/4
5	5/16 in	21,09	1	59S/50H5/16
5	3/8 in	21,09	1	59S/50H3/8

Punta estándar Robertson - 50 mm



**59S/50R**

X	Icon	€	Icon	Icon
5	#1	28,57	1	59S/50R1
2	#1	11,44	50	59S/50R1-2P
5	#2	28,57	1	59S/50R2
2	#2	11,44	50	59S/50R2-2P
5	#3	28,57	1	59S/50R3
2	#3	11,44	50	59S/50R3-2P

Punta estándar Phillips - 70 mm



**59S/70PH**

X	Icon	€	Icon	Icon
5	1	23,81	25	59S/70PH1-5P
2	1	9,53	1	59S/70PH1-2P
5	2	23,81	25	59S/70PH2-5P
2	2	9,53	25	59S/70PH2-2P

Punta estándar Pozidriv - 70 mm



**59S/70PZ**

X	Icon	€	Icon	Icon
5	1	23,81	25	59S/70PZ1-5P
2	1	9,53	1	59S/70PZ1-2P
5	2	23,81	25	59S/70PZ2-5P
2	2	9,53	1	59S/70PZ2-2P
5	3	23,81	1	59S/70PZ3
2	3	9,53	1	59S/70PZ3-2P

Punta estándar Torx - 70 mm



### 59S/70T

	X		€		
5	T10	28,57	25	59S/70T10-5P	
2	T10	11,44	1	59S/70T10-2P	
5	T15	28,57	25	59S/70T15-5P	
2	T15	11,44	25	59S/70T15-2P	
2	T20	11,44	25	59S/70T20-2P	
5	T20	28,57	25	59S/70T20-5P	
2	T25	11,44	25	59S/70T25-2P	
5	T25	28,57	25	59S/70T25-5P	
5	T27	28,57	1	59S/70T27	
2	T27	11,44	1	59S/70T27-2P	
2	T30	11,44	1	59S/70T30-2P	
5	T30	28,57	25	59S/70T30-5P	
5	T40	28,57	25	59S/70T40-5P	
2	T40	11,44	1	59S/70T40-2P	

Puntas de destornillador estándar de 1/4" para tornillos TORX® inviolables de 70 mm



### 59S/70TR

	X		€		
5	TR15	42,18	1	59S/70TR15	
2	TR15	16,86	1	59S/70TR15-2P	
5	TR20	42,18	1	59S/70TR20	
2	TR20	16,86	25	59S/70TR20-2P	
5	TR25	42,18	1	59S/70TR25	
2	TR25	16,86	25	59S/70TR25-2P	
5	TR27	42,18	1	59S/70TR27	
2	TR27	16,86	25	59S/70TR27-2P	
5	TR30	42,18	1	59S/70TR30	
2	TR30	16,86	25	59S/70TR30-2P	
5	TR40	42,18	1	59S/70TR40	
2	TR40	16,86	25	59S/70TR40-2P	

Puntas de destornillador estándar de 1/4" para tornillos de punta de bola de 89 mm



### 59S/H BALL

	X		€		
5		3	42,18	1	59S/H3BALL
2		3	16,86	1	59S/H3BALL-2P
2		4	16,86	1	59S/H4BALL-2P
5		5	42,18	1	59S/H5BALL
2		5	16,86	1	59S/H5BALL-2P
5		6	42,18	1	59S/H6BALL
2		6	16,86	1	59S/H6BALL-2P
5		8	42,18	1	59S/H8BALL
2		8	16,86	1	59S/H8BALL-2P
3		5,6,8	25,25	1	59S/HBALL-3P

Punta estándar Phillips - 125 mm



### 59S/125PH

	X		€		
2		1	14,15	25	59S/125PH1-2P
2		2	14,15	25	59S/125PH2-2P
100		2	2,66	100	59S/125PH2-IP
2		3	14,15	25	59S/125PH3-2P
5		3	35,39	1	59S/125PH3

Punta estándar Pozidriv - 125 mm



### 59S/125PZ

	X		€		
5		1	35,39	1	59S/125PZ1
2		1	14,15	25	59S/125PZ1-2P
5		2	35,39	1	59S/125PZ2
2		2	14,15	25	59S/125PZ2-2P
5		3	35,39	1	59S/125PZ3
2		3	14,15	25	59S/125PZ3-2P

Bolsa 2 Puntas combi para terminales (boca recta/Phillips), 125mm



### 59S/PH COMBI

	X		€		
2		5.0/PH1	16,86	1	59S/PH1COMBI-2P
2		6.0/PH2	16,87	40	59S/125PH2COMBI-2P
2		8.0/PH3	16,86	1	59S/PH3COMBI-2P

Punta estándar Torx - 150 mm



### 59S/150T

	X		€		
5		T15	53,08	1	59S/150T15
2		T15	21,23	1	59S/150T15-2P
2		T20	21,23	1	59S/150T20-2P
2		T25	21,23	1	59S/150T25-2P
2		T30	21,23	1	59S/150T30-2P

Puntas para tornillos hexagonales 7/16"



### 74S/H

	X		€		
5		4 mm	43,72	1	74S/H4
2		4 mm	17,49	25	74S/H4-2P
2		5 mm	17,49	25	74S/H5-2P
5		6 mm	43,72	1	74S/H6
2		6 mm	17,49	25	74S/H6-2P
5		7 mm	43,72	1	74S/H7
2		7 mm	17,49	25	74S/H7-2P
5		8 mm	43,72	1	74S/H8
2		8 mm	17,49	25	74S/H8-2P
5		10 mm	43,72	1	74S/H10
2		10 mm	17,49	25	74S/H10-2P
5		12 mm	58,26	1	74S/H12
2		12 mm	23,30	25	74S/H12-2P
5		14 mm	58,26	1	74S/H14
2		14 mm	23,30	1	74S/H14-2P
5		17 mm	58,26	1	74S/H17
2		17 mm	23,30	25	74S/H17-2P



Puntas para tornillos Phillips 5/32"



**45S/PH**

QTY	SIZE	PRICE	PKTS	ITEM
5	1	17,40	1	45S/PH1
2	1	6,95	50	45S/PH1-2P
5	2	19,50	1	45S/PH2
2	2	7,80	50	45S/PH2-2P

Puntas para tornillos hexagonales 5/32"



**45S/H**

QTY	SIZE	PRICE	PKTS	ITEM
5	1.5 mm	18,09	1	45S/H1.5
2	1.5 mm	7,23	50	45S/H1.5-2P
5	2 mm	18,09	1	45S/H2
2	2 mm	7,23	50	45S/H2-2P
5	2.5 mm	18,09	1	45S/H2.5
2	2.5 mm	7,23	50	45S/H2.5-2P
5	3 mm	18,09	1	45S/H3
2	3 mm	7,23	50	45S/H3-2P

Juego de 6 puntas Phillips, Pozidriv, TORX® y adaptador magnético



**59S/7-1**

QTY	SIZE	PRICE	PKTS	ITEM
7	22 x 65 x 75 mm	12,76	1	59S/7-1*

59S/PH1, 59S/PH2		
59S/PZ1, 59S/PZ2		
59S/T15, 59S/T20		

Juego de 6 puntas Phillips, TORX® y adaptador magnético



**59S/7-2**

QTY	SIZE	PRICE	PKTS	ITEM
7	22 x 65 x 75 mm	13,47	1	59S/7-2

59S/PH2		
59S/T15x 2, 59S/T20x 2, 59S/T25		

Juego de 6 puntas TORX® Inviolable y adaptador magnético



**59S/7-3**

QTY	SIZE	PRICE	PKTS	ITEM
7	22 x 65 x 75 mm	23,89	1	59S/7-3

59S/TR10, 59S/TR15, 59S/TR20, 59S/TR25, 59S/TR30, 59S/TR40		
--	--	--

Juego de 6 puntas TORX® y adaptador magnético



**59S/7-4**

QTY	SIZE	PRICE	PKTS	ITEM
7	22 x 65 x 75 mm	13,95	1	59S/7-4

59S/T10, 59S/T15, 59S/T20, 59S/T25, 59S/T30, 59S/T40		
--	--	--

Juego de puntas 10 piezas para PH, Pozidriv y Torx



**59S/10BC**

QTY	SIZE	PRICE	PKTS	ITEM
10	23 x 68 x 168 mm	4,66	1	59S/10BC

Juego de puntas Torx 11 piezas: 10 puntas y un adaptador magnético de liberación rápida



**59S/TCS11-1**

QTY	SIZE	PRICE	PKTS	ITEM
11	108 x 68 x 31 mm	19,03	10	59S/TCS11-1

59S/T10CS, 59S/T15CS, 59S/T20CSx 3, 59S/T25CSx 2, 59S/T30CSx 2, 59S/T40CS		
KM653-QR-1P		

Juego de 16 puntas rectas, Phillips, Pozidriv



**59S/17-1**

QTY	SIZE	PRICE	PKTS	ITEM
17	27 x 73 x 82 mm	22,34	1	59S/17-1

59S/0.5-3.0, 59S/0.6-4.5, 59S/0.8-5.5		
59S/PH1, 59S/PH2x 3		
59S/PH2Gx 2		
59S/PZ1, 59S/PZ2x 2		
59S/H3, 59S/H4, 59S/H5, 59S/H6		

Juego de 17 puntas TORX® y adaptador magnético



**59S/17-2**

		€		
17	27 x 73 x 82 mm	23,35	1	59S/17-2

59S/T7, 59S/T8, 59S/T9, 59S/T10, 59S/T15x 2, 59S/T20x 3, 59S/T25x 3, 59S/T27, 59S/T30x 2, 59S/T40

Juego de 17 puntas Pozidriv, Phillips y TORX® y adaptador magnético



**59S/17-3**

		€		
17	27 x 73 x 82 mm	22,65	1	59S/17-3*

59S/PH1, 59S/PH2x 2

59S/PZ1, 59S/PZ2, 59S/PZ3

59S/T10, 59S/T15, 59S/T20, 59S/T25, 59S/T27, 59S/T30, 59S/T40

59S/H3, 59S/H4, 59S/H5

Juego de puntas de 22 piezas Boca recta, Phillips, Pozidriv, TORX® y adaptador para vasos 1/4"



**59S/22-1**

		€		
22	20 x 50 x 80 mm	31,69	12	59S/22-1

59S/0.5-3.0, 59S/0.6-4.5, 59S/0.8-5.5

59S/PH1, 59S/PH2, 59S/PH3

59S/PH2G

59S/PZ1, 59S/PZ2, 59S/PZ3

59S/T6, 59S/T8, 59S/T9, 59S/T10, 59S/T15, 59S/T20, 59S/T25, 59S/T27, 59S/T30, 59S/T40

K6650-1/4

Juego de 22 puntas Phillips, TORX® hexagonales,



**59S/22-2**

		€		
22	20 x 50 x 80 mm	31,69	12	59S/22-2

59S/PH2x 3

59S/PH2Gx 3

59S/PZ2x 2

59S/T10, 59S/T15x 4, 59S/T20x 3, 59S/T25x 2

59S/H2.5, 59S/H3

K6650-1/4

Juego de adaptador y 28 puntas, tornillos Ranurados



**59S/28**

		€		
28	30 x 58 x 110 mm	120,85	1	59S/28-4

59S/0.6-4.5, 59S/1.2-6.5, 59S/1.2-8.0

59S/PH1-10Px 2, 59S/PH2-10Px 2, 59S/PH3-10P

59S/T6-3P, 59S/T15-3P

59S/H5/64-5P, 59S/H3/32-5P, 59S/H7/64-5P, 59S/H1/8-5P, 59S/H9/64, 59S/H5/32-5P, 59S/H3/16-5P, 59S/H7/32-5P

59S/TS-4-5Px 2, 59S/TS-6-5Px 2, 59S/TS-8-5Px 2, 59S/TS-10-5Px 2

K6625-1/4B-5P

KM653-5P

Juego de 31 puntas para tornillos ranurados, Phillips, Pozidriv, TORX® y hexagonales, porta puntas y adaptador de 1/4"



**59S/31B**

		€		
31	40.25 x 104.90 x 65.35 mm	16,18	6	59S/31B

1P: Envase unitario colgador plástico

59S/0.6-4.5, 59S/1.0-5.5

59S/PH1, 59S/PH2x 3, 59S/PH3

59S/PH2Gx 2

59S/PZ1, 59S/PZ2x 3, 59S/PZ3

59S/T10, 59S/T15x 3, 59S/T20x 3, 59S/T25x 2, 59S/T27, 59S/T30

59S/H3, 59S/H4, 59S/H5, 59S/H6

K6625-1/4-1P

KM653-QR-1P

Display con 12 juegos de puntas 1/4" 59/S31B



**59S/31B-IP**

		€		
12	105 x 375 x 205 mm	15,86	12	59S/31B-IP

\* Hasta agotar existencias





Juego de 31 puntas rectas, Phillips, Pozidriv TORX®, hexagonales y portapuntas magnético



### 59S/31-1

		€		
31	42 x 65 x 110 mm	24,76	12	59S/31-1

59S/0.5-3.0, 59S/0.6-4.5, 59S/0.8-5.5		
59S/PH1, 59S/PH2x 3, 59S/PH3		
59S/PH2Gx 2		
59S/PZ1, 59S/PZ2x 3, 59S/PZ3		
59S/T10, 59S/T15x 3, 59S/T20x 3, 59S/T25x 2, 59S/T27, 59S/T30		
59S/H3, 59S/H4, 59S/H5, 59S/H6		
KM653-QR		

Juego de 31 puntas Phillips, Pozidriv, TORX® y



### 59S/31-2

		€		
31	42 x 65 x 110 mm	25,46	1	59S/31-2

59S/PH2x 4		
59S/PH2Gx 4		
59S/PZ2x 4		
59S/T10x 2, 59S/T15x 4, 59S/T20x 5, 59S/T25x 5, 59S/T30x 2		
KM653-QR		

Juego de puntas 35 piezas: 29 puntas, 4 adaptadores magnéticos, 1 porta puntas magnético liberación rápida, 1 adaptador



### 59/S35BC

		€		
35	50 x 110 x 180 mm	66,28	1	59/S35BC

Juego de puntas de 54 piezas para tornillos ranurados, Phillips, Pozidriv, TORX®, TORX® Tamper, Hexagonales y Robertson



### 59/S54BC

		€		
54	50 x 110 x 184 mm	35,60	20	59/S54BC

Display con 8 juegos de puntas de 54 piezas 59/S54BC



### 59/S54BC-IP

		€		
54	300 x 190 x 280 mm	35,60	8	59/S54BC-IP

Puntas Torx con código de colores

Juego de puntas de 100 piezas para tornillos ranurados, Phillips, Pozidriv, TORX®, TORX® Tamper, Hexagon, Robertson



### 59/S100BC

		€		
100	50 x 110 x 184 mm	46,61	1	59/S100BC

Display con 8 juegos de puntas de 100 piezas 59/S100BC



### 59/S100BC-IP

		€		
100	300 x 190 x 280 mm	46,61	8	59/S100BC-IP

Puntas Torx con código de colores

Juego de 18 puntas, 5 vasos, carraca para puntas y adaptadores



### 2058/S26

		€		
26	80 x 100 x 35 mm	38,89	30	2058/S26



6950CBR	
K6625-1/4-1P	
59S/H6, 59S/H5, 59S/H4, 59S/H3	
59S/T15, 59S/T10, 59S/T30, 59S/T25, 59S/T20	
59S/PZ3, 59S/PZ1, 59S/PZ2	
59S/PH1, 59S/PH2, 59S/PH3	
59S/0.8-5.5, 59S/0.5-4.0	
6700SM-8, 6700SM-7, 6700SM-6, 6700SM-13, 6700SM-10	
59S/1.0-6.0-IP	

Juego de puntas y vasos pequeños de 1/4" para tornillos ranurados/de cabeza Phillips/ozidriv/TORX®/Hex Paquete al por menor - 26 piezas



**SB2058/S26**

		€		
26	35 x 85 x 105 mm	39,40	12	SB2058/S26

Juego de puntas y vasos estándar de 1/4" para tornillo de cabeza ranurada/ Phillips/ Pozidriv/TORX®/Hex - 26 piezas



**2058/S26AF**

		€		
26	80 x 100 x 35 mm	24,95	1	2058/S26AF

Juego de puntas con puntas, vasos, carraca para puntas y adaptadores, 26 piezas



**2058/S26-2**

		€		
26	80 x 100 x 35 mm	38,90	1	2058/S26-2

2058-BR, K6625-1/4, KM653-QR	
6700SM-8, 6700SM-7, 6700SM-6, 6700SM-5, 6700SM-4	
59S/0.5-3.0, 59S/0.8-5.5, 59S/0.5-4.0	
59S/T8, 59S/T7, 59S/T6, 59S/T5, 59S/T4	
59S/PZ1, 59S/PZ0, 59S/PZ2	
59S/H2, 59S/H2.5, 59S/H1.5, 59S/H3	
59S/PH1, 59S/PH0, 59S/PH2	

5 puntas PH2 25mm en envase tipo "boli"

		€		
5	13 x 17 x 132 mm	3,16	10	59S/PH2PEN*



**59S/PH2PEN**

		€		
5	13 x 17 x 132 mm	3,16	10	59S/PH2PEN*

5 puntas PZ2 25mm en envase tipo "boli"

		€		
5	13 x 17 x 132 mm	3,16	10	59S/PZ2PEN*



**59S/PZ2PEN**

		€		
5	13 x 17 x 132 mm	3,16	10	59S/PZ2PEN*

5 puntas TORX en envase tipo "boli"



**59S/TORXPEN**

		€		
5	13 x 17 x 132 mm	3,69	10	59S/T15PEN*
5	13 x 17 x 132 mm	3,69	10	59S/T20PEN*
5	13 x 17 x 132 mm	3,69	10	59S/T25PEN*

Dispensador 60 puntas en envase tipo "boli"



**59S/60PEN/DISP**

		€		
60	140 x 125 x 215 mm	189,84	1	59S/60PEN/DISP*

59S/T15PENx 5, 59S/T20PENx 30, 59S/T25PENx 5	
59S/PH2PENx 10	
59S/PZ2PENx 10	

Puntas para tornillos ranurados



**70S/**

		€		
2	8.0 mm	8,63	25	70S/1.2-8.0-2P
5	9.0 mm	21,58	1	70S/1.6-9.0
2	9.0 mm	8,63	25	70S/1.6-9.0-2P
2	10.0 mm	12,26	25	70S/1.6-10.0-2P
5	12.0 mm	33,49	1	70S/2.0-12.0
2	12.0 mm	13,39	25	70S/2.0-12.0-2P
5	14.0 mm	37,78	1	70S/2.5-14.0
2	14.0 mm	15,12	25	70S/2.5-14.0-2P

\* Hasta agotar existencias



Puntas para tornillos Phillips



70S/PH



X		€		
5	1	18,96	1	70S/PH1
2	1	7,59	25	70S/PH1-2P
5	2	18,96	1	70S/PH2
2	2	7,59	25	70S/PH2-2P
5	3	18,96	1	70S/PH3
2	3	7,59	25	70S/PH3-2P
5	4	18,96	1	70S/PH4
2	4	7,59	25	70S/PH4-2P

Puntas para tornillos Pozidriv®



70S/PZ



X		€		
5	1	18,96	1	70S/PZ1
2	1	7,59	25	70S/PZ1-2P
5	2	18,96	1	70S/PZ2
2	2	7,59	25	70S/PZ2-2P
5	3	18,96	1	70S/PZ3
2	3	7,59	25	70S/PZ3-2P
5	4	18,96	1	70S/PZ4
2	4	7,59	25	70S/PZ4-2P

Puntas para tornillos TORX® 5/16", 35mm



70S/T



X		€		
5	T25	23,77	50	70S/T25-5P
5	T40	23,77	50	70S/T40-5P
5	T20	23,77	1	70S/T20

X		€		
2	T20	9,51	25	70S/T20-2P
2	T25	9,51	25	70S/T25-2P
2	T27	9,51	1	70S/T27-2P
2	T30	9,51	25	70S/T30-2P
5	T45	23,77	1	70S/T45
2	T45	9,51	25	70S/T45-2P
5	T50	23,77	1	70S/T50
2	T50	9,51	25	70S/T50-2P*
5	T55	32,90	1	70S/T55
2	T55	13,14	25	70S/T55-2P

Puntas para tornillos Torque-set®



70S/TS



X		€		
5	8 mm	44,42	1	70S/TS8
2	8 mm	17,77	25	70S/TS8-2P
5	10 mm	44,42	1	70S/TS10
2	10 mm	17,77	25	70S/TS10-2P

Puntas de impacto Torq-Set® -32 mm



70S/TS''



X		€		
5	1/4"	39,61	1	70S/TS1/4
2	1/4"	15,84	25	70S/TS1/4-2P
5	5/16"	44,42	1	70S/TS5/16
2	5/16"	17,77	25	70S/TS5/16-2P

Puntas para tornillos Hexagonales



70S/H



X		€		
5	4 mm	18,96	1	70S/H4
2	4 mm	7,59	25	70S/H4-2P
2	5 mm	7,59	25	70S/H5-2P
2	6 mm	7,59	25	70S/H6-2P
5	7 mm	18,96	1	70S/H7
2	7 mm	7,59	25	70S/H7-2P
2	8 mm	7,59	25	70S/H8-2P
5	10 mm	22,93	1	70S/H10*
2	10 mm	9,17	25	70S/H10-2P
5	12 mm	24,42	1	70S/H12
2	12 mm	9,75	25	70S/H12-2P
5	14 mm	24,42	1	70S/H14
2	14 mm	9,75	25	70S/H14-2P

Destornillador de impacto 1/2" para puntas 5/16"



5521

L	€		
125 mm	54,73	1	5521

Adaptador para puntas de destorgolpe



54640

L	€		
40 mm	20,17	1	54640

Cuadrado 1/2" Para puntas 5/16" Para destornillador ref. 5521

Juego de puntas y destornillador a golpe cuadrado 1/2"



**7823**



23 45 x 70 x 197 mm 77,72 16 7823

22 Puntas 5/16" (3 boca recta, 3 phillips, 8 hex, 8 Torx®)

5521	
54640	
70S/1.2-8.0, 70S/1.6-10.0, 70S/2.0-12.0	
70S/PH2, 70S/PH3, 70S/PH4	
70S/T20, 70S/T25, 70S/T27, 70S/T30, 70S/T40, 70S/T45, 70S/T50, 70S/T55	
70S/H4, 70S/H5, 70S/H6, 70S/H7, 70S/H8, 70S/H10, 70S/H12, 70S/H14	

Juego de destornillador a golpe de 1/4" con puntas: Recta, Phillips®, Pozidriv®, Torx®, hexagonales y adaptador - 15 piezas



**7865**

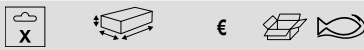

15 55 x 90 x 220 mm 45,13 1 7865

2 puntas rectas (5,6mm) incluidas en el juego incluye 1 adaptador (hexagonal 5/16" a 3/8") y 2 puntas ranuradas (5,6 mm)

5521	
54640	
70S/1.2-8.0, 70S/1.6-10.0	
70S/PH1, 70S/PH2, 70S/PH3, 70S/PH4	
70S/H4, 70S/H5, 70S/H6, 70S/H8	

Puntas roscadas para tornillos de cabeza Phillips



**K18**

		€			
1	2	7,77	5		K18NF-2
1	2	8,62	5		K18PH-2M5
1	2	8,66	5		K18PH-2M6

Punta Pozidriv con rosca



**K19PZD-2NF**

		€			
1	2	7,77	1		K19PZD-2NF
1	2	7,77	1		K19PZD-2M5

Punta TORX® con rosca



**K20TORX**

		€			
1	T25	10,98	10		K20TORX-T25

Adaptador, 50 mm



**K6750**

		€			
1	1/4 in	6,26	1		K6750-6
1	1/4 in	6,26	1		K6750-7*
1	1/4 in	6,26	20		K6750-8-1P
1	1/4 in	6,26	20		K6750-10-1P
1	1/4 in	6,26	1		K6750-13
1	1/4 in	6,26	1		K6750-1/4
1	1/4 in	6,26	1		K6750-3/8

Adaptador magnético, 50 mm



**KM6750**

	€			
1	7,63	1		KM6750-6
1	7,63	1		KM6750-7-1P
1	7,63	1		KM6750-8-1P
1	7,63	1		KM6750-10-1P
1	7,63	1		KM6750-11-1P
1	7,63	1		KM6750-13-1P
1	7,63	1		KM6750-1/4
1	7,63	1		KM6750-3/8

Caja 5 Adaptadores con imán con sistema de ajuste rápido, 60mm



**KM653-QR**

		€			
1	1/4"	15,77	50		KM653-QR-1P
5	1/4"	67,93	25		KM653-QR-5P

\* Hasta agotar existencias



Adaptador de ajuste rápido magnético, 75 mm



**KM753-QR**

		€		
1	1/4 in	17,69	1	KM753-QR-1P

Porta puntas torsión 75mm



**KMT753-QR-1P**

		€		
1/4 in	1/4 in	10,54	50	KMT753-QR-1P

Caja 5 Adaptadores universales magnéticos de 1/4" con anilla de retención 75mm



**KMR753**

		€		
1	1/4 in	8,48	1	KMR753-1P
5	1/4 in	42,46	1	KMR753

-1P: Envase unitario en soporte plástico

Caja 5 Adaptadores universales de 1/4" con anilla de retención, 60 mm



**KR653**

		€		
1	1/4 in	6,02	25	KR653-1P
5	1/4 in	30,07	1	KR653

Adaptador angular de 1/4"



**KM653-SF**

		€		
1	1/4" in	18,41	1	KM653-SF

Adaptador universal de 1/4" de cobre-berilio



**KCB753**

		€		
1	1/4 in	47,54	1	KCB753

Caja 5 Adaptadores con imán sin anillo interno



**KM653**

		€		
1	1/4"	6,18	25	KM653-1P
5	1/4"	30,92	25	KM653-5P

KM653-1P Envase unitario

Caja 5 Adaptadores universales magnéticos de 1/4" con anilla de retención 60mm



**KMR653**

		€		
1	1/4 in	9,26	1	KMR653-1P
5	1/4 in	26,71	50	KMR653-5P

-1P: Envase unitario en soporte plástico

Caja 5 Adaptadores universales magnéticos de 1/4" con anilla de retención 150mm



**KMR150**

		€		
1	1/4 in	16,26	1	KMR150-1P

-1P: Envase unitario en soporte plástico

Adaptador magnético para puntas 5/16"



**KM1/4-5/16-1P**

X	Hexagon	€	Box	Weight	Part
1	1/4 in	6,99	50		KM1/4-5/16-1P

Caja 5 Adaptadores hexágono 1/4" y cuadrado 1/4", 25mm



**K6625**

X	Hexagon	€	Box	Weight	Part
1	1/4 in	5,44	80		K6625-1/4B-1P
5	1/4 in	27,24	50		K6625-1/4B-5P

-1P: Envase unitario en soporte plástico

Caja 5 Adaptadores cuadrado 1/4" y hexágono 3/8" 38mm



**K6638**

X	Hexagon	€	Box	Weight	Part
1	1/4 in	6,38	25		K6638-3/8-1P
5	1/4 in	31,84	1		K6638-3/8

1P: Envase unitario soporte plástico

Caja 5 adaptadores hexágono y cuadrado, 50 mm



**K6650**

X	Hexagon	€	Box	Weight	Part
1	1/4 in	9,00	20		K6650-1/4B-1P
5	1/4 in	44,92	50		K6650-1/4P-5P
5	1/4 in	60,15	25		K6650-3/8P-5P
5	1/4 in	74,30	25		K6650-1/2P-5P
1	1/4 in	12,03	20		K6650-3/8P-1P
1	1/4 in	14,85	20		K6650-1/2P-1P

-1P: Envase unitario en soporte plástico Con pivote (excepto K6650-1/4-1P con bola)

Caja 5 Adaptadores hexágono y cuadrado, 100 mm



**K66100**

X	Hexagon	€	Box	Weight	Part
1	1/4 in	11,19	20		K66100-1/4P-1P
5	1/4 in	55,90	1		K66100-1/4
1	1/4 in	14,15	25		K66100-3/8-1P
5	1/4 in	70,75	1		K66100-3/8

K66100-1/4 con pivote K66100-3/8 con bola 1P: Envase unitario soporte plástico

Adaptador de ajuste rápido de 1/4", 60 mm



**K6660-QR**

X	Hexagon	€	Box	Weight	Part
1	1/4 in	14,57	1		K6660-QR-1P

**VASOS DE IMPACTO**

Vaso de impacto hexagonal 1/4"



**K6701M**

Hexagon	€	Box	Weight	Part
6 mm	7,57	1		K6701M-6
7 mm	7,57	1		K6701M-7
8 mm	7,61	1		K6701M-8
9 mm	7,61	1		K6701M-9
10 mm	7,61	1		K6701M-10
11 mm	7,61	1		K6701M-11
12 mm	9,49	1		K6701M-12
13 mm	9,49	1		K6701M-13
14 mm	9,49	1		K6701M-14

Vasos de impacto hexagonales, mm, 1/4", en clip



**SBK6701M**

Hexagon	€	Box	Weight	Part
6 mm	7,57	1		SBK6701M-6
7 mm	7,57	1		SBK6701M-7
8 mm	7,57	1		SBK6701M-8
9 mm	7,57	1		SBK6701M-9
10 mm	7,57	1		SBK6701M-10
11 mm	7,57	1		SBK6701M-11
12 mm	9,38	1		SBK6701M-12
13 mm	9,38	1		SBK6701M-13
14 mm	9,38	1		SBK6701M-14

\* Hasta agotar existencias





Vaso impacto 1/4" magnético



**KM6701M**

Ø	€		
7 mm	32,51	1	KM6701M-7
8 mm	32,91	1	KM6701M-8
10 mm	33,95	1	KM6701M-10

Muelle de fijación



**K560F-1**

Ø	Ø	€		
1/4 in	6-14 mm	3,34	5	K560F-1

Vaso de impacto hexagonal 3/8", mm



**K7401M**

Ø	€		
7 mm	8,96	1	K7401M-7
8 mm	8,96	1	K7401M-8
9 mm	8,96	1	K7401M-9
10 mm	8,96	1	K7401M-10
11 mm	8,96	1	K7401M-11
12 mm	8,96	1	K7401M-12
13 mm	8,96	1	K7401M-13
14 mm	8,96	1	K7401M-14
15 mm	8,96	1	K7401M-15
16 mm	8,96	1	K7401M-16
17 mm	8,96	1	K7401M-17
18 mm	10,65	1	K7401M-18
19 mm	10,65	1	K7401M-19

Ø	€		
20 mm	10,95	1	K7401M-20
21 mm	10,95	1	K7401M-21
22 mm	11,45	1	K7401M-22
24 mm	11,63	1	K7401M-24

Vasos de impacto hexagonales, mm, 3/8", en clip



**SBK7401M**

Ø	€		
7 mm	8,66	1	SBK7401M-7
8 mm	8,66	1	SBK7401M-8
9 mm	8,66	1	SBK7401M-9
10 mm	8,66	1	SBK7401M-10
11 mm	8,66	1	SBK7401M-11
12 mm	8,66	1	SBK7401M-12
13 mm	8,66	1	SBK7401M-13
14 mm	8,66	1	SBK7401M-14
15 mm	8,66	1	SBK7401M-15
16 mm	8,66	1	SBK7401M-16
17 mm	8,66	1	SBK7401M-17
18 mm	10,18	1	SBK7401M-18
19 mm	10,18	1	SBK7401M-19
20 mm	10,48	1	SBK7401M-20
21 mm	10,48	1	SBK7401M-21
22 mm	10,94	1	SBK7401M-22
24 mm	11,03	1	SBK7401M-24

Vaso de impacto serie larga 3/8", mm



**K7406M**

Ø	€		
10 mm	10,02	1	K7406M-10
13 mm	11,38	1	K7406M-13
17 mm	12,41	1	K7406M-17

Vaso de impacto hexagonal 3/8", en pulgadas



**K7401Z**

Ø	€		
3/8 in	9,45	1	K7401Z-3/8*
7/16 in	9,45	1	K7401Z-7/16*
1/2 in	9,45	1	K7401Z-1/2*
9/16 in	9,45	1	K7401Z-9/16*
5/8 in	9,45	1	K7401Z-5/8*
11/16 in	9,45	1	K7401Z-11/16*
3/4 in	9,45	1	K7401Z-3/4*
13/16 in	9,45	1	K7401Z-13/16*
7/8 in	9,45	1	K7401Z-7/8*

Adaptador de impacto de 3/8" para puntas de 1/4"



**K172**

Ø	€		
1/4"	33,64	1	K172

Adaptador de impacto portapuntas 3/8"



**7407H-7409H**

Ø	Ø	€		
1/4"	3/8"	25,99	1	7407H
5/16"	3/8"	25,99	1	7408H
11	3/8"	30,12	1	7409H

Vaso de impacto 3/8" TORX®



**K7401TORX-E**



Icon	Icon	€	Icon	Icon
E5	M4	11,76	1	K7401TORX-E5*
E6	M5	11,76	1	K7401TORX-E6*
E7	M6	11,76	1	K7401TORX-E7*
E8	M6, M7	11,76	1	K7401TORX-E8*
E10	M6, M8	11,76	1	K7401TORX-E10*
E12	M8, M10	11,76	1	K7401TORX-E12*
E14	M10, M12	11,76	1	K7401TORX-E14*

Vaso de impacto giratorio hexagonal 3/8", mm



**KS7401M**



Icon	€	Icon	Icon
3/8 in	34,55	1	KS7401M-9*
3/8 in	34,55	1	KS7401M-10*
3/8 in	34,55	1	KS7401M-11*
3/8 in	34,55	1	KS7401M-12*
3/8 in	34,55	1	KS7401M-13*
3/8 in	35,71	1	KS7401M-14*
3/8 in	35,71	1	KS7401M-15*
3/8 in	35,71	1	KS7401M-16*
3/8 in	35,71	1	KS7401M-17*
3/8 in	35,71	1	KS7401M-18*
3/8 in	35,71	1	KS7401M-19*
3/8 in	38,54	1	KS7401M-22*

Articulación universal de impacto 3/8"



**K7767S**

Icon	Icon	€	Icon	Icon
3/8"	3/8"	34,90	1	K7767S

Reductor/Amplificador de impacto 3/8"



**K6964C**

Icon	Icon	€	Icon	Icon
1/4"	3/8"	23,90	1	K6964C

Este producto no está garantizado contra la rotura del cuadrado macho

Adaptadores con cuadrado de 3/8" con acabado fosfatado



**K8164C**

Icon	Icon	€	Icon	Icon
1/2"	3/8"	23,90	1	K8164C

Alargadera de impacto 3/8"



**K7760C**

Icon	€	Icon	Icon
75 mm	16,50	1	K7760C-1
150 mm	23,72	1	K7760C-2

Muelle de fijación



**K560F-2/3**

Icon	Icon	€	Icon	Icon
3/8"	7-12	3,34	5	K560F-2
3/8"	13-24	3,34	5	K560F-3

Juego de vasos de impacto, 10 piezas



**K7401M/10**

Icon	g	€	Icon	Icon
10	700 g	89,05	1	K7401M/10

K7401M-10, K7401M-11, K7401M-12, K7401M-13, K7401M-14, K7401M-15, K7401M-16, K7401M-17, K7401M-18, K7401M-19

\* Hasta agotar existencias



Juego de 7 vasos de impacto 3/8" E TORX®



**K7401TORX-E-S7**



		€		
7	340 g	82,36	1	K7401TORX-E-S7*

K7401TORX-E5, K7401TORX-E6,  
K7401TORX-E7, K7401TORX-E8,  
K7401TORX-E10, K7401TORX-E12,  
K7401TORX-E14

Vaso de impacto hexagonal 1/2" mm, ultracorto



**K7800M**

Ø	€		
10 mm	6,54	1	K7800M-10
11 mm	6,54	1	K7800M-11
12 mm	6,54	1	K7800M-12
13 mm	6,54	1	K7800M-13
14 mm	6,65	1	K7800M-14
15 mm	6,65	1	K7800M-15
16 mm	6,65	1	K7800M-16
17 mm	6,95	1	K7800M-17
18 mm	6,95	1	K7800M-18
19 mm	6,95	1	K7800M-19
21 mm	6,95	1	K7800M-21
22 mm	7,07	1	K7800M-22
24 mm	7,64	1	K7800M-24

Vaso de impacto 1/2", hexagonal



**K7801M**

Ø	€		
8 mm	6,26	1	K7801M-8
9 mm	6,26	1	K7801M-9
10 mm	10,60	1	K7801M-10

Ø	€		
11 mm	10,60	1	K7801M-11
12 mm	10,60	1	K7801M-12
13 mm	10,60	1	K7801M-13
14 mm	10,97	1	K7801M-14
15 mm	11,19	1	K7801M-15
16 mm	11,19	1	K7801M-16
17 mm	11,71	1	K7801M-17
18 mm	11,71	1	K7801M-18
19 mm	11,71	1	K7801M-19
20 mm	12,35	1	K7801M-20
21 mm	12,42	1	K7801M-21
22 mm	12,57	1	K7801M-22
23 mm	12,95	1	K7801M-23
24 mm	13,14	1	K7801M-24
25 mm	15,21	1	K7801M-25
26 mm	15,64	1	K7801M-26
27 mm	15,64	1	K7801M-27
28 mm	15,64	1	K7801M-28
29 mm	15,80	1	K7801M-29
30 mm	19,16	1	K7801M-30
32 mm	27,44	15	K7801M-32
34 mm	30,99	1	K7801M-34
36 mm	32,03	1	K7801M-36

Vasos de impacto hexagonales, mm, 1/2", en clip



**SBK7801M**

Ø	€		
8 mm	8,22	1	SBK7801M-8
9 mm	8,22	1	SBK7801M-9
10 mm	10,35	1	SBK7801M-10
11 mm	10,35	1	SBK7801M-11
12 mm	10,35	1	SBK7801M-12
13 mm	10,35	1	SBK7801M-13
14 mm	10,71	1	SBK7801M-14
15 mm	10,71	1	SBK7801M-15
16 mm	10,71	1	SBK7801M-16
17 mm	11,72	1	SBK7801M-17
18 mm	11,72	1	SBK7801M-18
19 mm	11,72	1	SBK7801M-19
20 mm	11,72	1	SBK7801M-20
21 mm	11,72	1	SBK7801M-21
22 mm	12,57	1	SBK7801M-22
23 mm	12,61	1	SBK7801M-23
24 mm	12,61	1	SBK7801M-24
25 mm	12,61	1	SBK7801M-25
26 mm	12,61	1	SBK7801M-26
27 mm	15,66	1	SBK7801M-27
28 mm	14,99	1	SBK7801M-28
29 mm	15,07	1	SBK7801M-29
30 mm	17,03	1	SBK7801M-30
32 mm	24,40	1	SBK7801M-32
34 mm	26,52	1	SBK7801M-34
36 mm	26,52	1	SBK7801M-36

Vaso de impacto serie larga 1/2", hexagonal



**K7806M**

Ø	€		
10 mm	12,92	1	K7806M-10
11 mm	12,92	1	K7806M-11
12 mm	12,92	1	K7806M-12
13 mm	12,92	1	K7806M-13
14 mm	12,92	1	K7806M-14
15 mm	13,06	1	K7806M-15
16 mm	13,06	1	K7806M-16
17 mm	13,06	1	K7806M-17
18 mm	13,10	1	K7806M-18
19 mm	13,10	1	K7806M-19
21 mm	13,10	1	K7806M-21
22 mm	13,10	1	K7806M-22
23 mm	13,71	1	K7806M-23
24 mm	13,52	1	K7806M-24
27 mm	15,78	1	K7806M-27
30 mm	17,84	1	K7806M-30
32 mm	20,84	1	K7806M-32
33 mm	22,15	1	K7806M-33
34 mm	22,15	1	K7806M-34
36 mm	24,12	1	K7806M-36

Vaso de impacto largo 1/2" hexagonal en mm, con acabado fosfatado



**SBK7806M**

Ø	€		
10 mm	13,54	1	SBK7806M-10
11 mm	13,54	1	SBK7806M-11
12 mm	13,54	1	SBK7806M-12
13 mm	13,54	1	SBK7806M-13
14 mm	13,54	1	SBK7806M-14
15 mm	13,70	1	SBK7806M-15
16 mm	13,70	1	SBK7806M-16
17 mm	13,70	1	SBK7806M-17
18 mm	13,74	1	SBK7806M-18
19 mm	13,74	1	SBK7806M-19
21 mm	13,74	1	SBK7806M-21
22 mm	13,74	1	SBK7806M-22
23 mm	14,35	1	SBK7806M-23
24 mm	14,16	1	SBK7806M-24
27 mm	16,41	1	SBK7806M-27
30 mm	18,48	1	SBK7806M-30
32 mm	21,48	1	SBK7806M-32
36 mm	24,76	1	SBK7806M-36

Vasos de impacto 1/2", hexagonal, pulgadas



**K7801Z**

Ø	€		
3/8 in	10,67	1	K7801Z-3/8
7/16 in	10,67	1	K7801Z-7/16
1/2 in	10,67	1	K7801Z-1/2
9/16 in	11,05	1	K7801Z-9/16
5/8 in	11,05	1	K7801Z-5/8
11/16 in	11,05	1	K7801Z-11/16
3/4 in	11,06	1	K7801Z-3/4
13/16 in	11,22	1	K7801Z-13/16
7/8 in	11,22	1	K7801Z-7/8
15/16 in	13,16	1	K7801Z-15/16
1 in	13,75	1	K7801Z-1
1 1/16 in	14,88	1	K7801Z-1.1/16
1 1/8 in	15,83	1	K7801Z-1.1/8
1 1/4 in	26,50	1	K7801Z-1.1/4
1 5/16 in	30,78	5	K7801Z-1.5/16
1 3/8 in	30,78	5	K7801Z-1.3/8
1 7/16 in	30,78	5	K7801Z-1.7/16
1 1/2 in	35,39	5	K7801Z-1.1/2

Vasos de impacto 1/2", serie larga, pulgadas



**K7806Z**

Ø	€		
3/8 in	14,19	10	K7806Z-3/8
7/16 in	14,19	5	K7806Z-7/16
1/2 in	14,19	10	K7806Z-1/2
9/16 in	14,19	10	K7806Z-9/16
5/8 in	14,36	5	K7806Z-5/8
11/16 in	14,36	5	K7806Z-11/16
3/4 in	14,40	5	K7806Z-3/4
13/16 in	14,40	5	K7806Z-13/16
7/8 in	14,40	5	K7806Z-7/8
15/16 in	14,86	5	K7806Z-15/16
1 in	16,24	5	K7806Z-1
1 1/16 in	17,35	5	K7806Z-1.1/16
1 1/8 in	19,63	5	K7806Z-1.1/8
1 1/4 in	30,36	5	K7806Z-1.1/4
1 5/16 in	35,27	5	K7806Z-1.5/16
1 3/8 in	35,27	5	K7806Z-1.3/8
1 7/16 in	35,27	5	K7806Z-1.7/16
1 1/2 in	40,53	5	K7806Z-1.1/2

Vaso de impacto 1/2" con punta hexagonal



**7993S**

Ø	€		
5 mm	45,37	1	7993S0050
6 mm	41,44	1	7993S0060
8 mm	41,44	1	7993S0080
10 mm	43,97	1	7993S0100
12 mm	43,97	1	7993S0120
14 mm	45,37	1	7993S0140
17 mm	45,37	1	7993S0170
18 mm	45,37	1	7993S0180
19 mm	45,37	1	7993S0190

Vaso de impacto 1/2" hexagonal en pulgadas, con acabado fosfatado



**SBK7801Z**

Ø	€		
3/8 in	11,33	1	SBK7801Z-3/8
7/16 in	11,33	1	SBK7801Z-7/16
1/2 in	11,33	1	SBK7801Z-1/2
9/16 in	11,70	1	SBK7801Z-9/16
5/8 in	11,70	1	SBK7801Z-5/8
11/16 in	11,70	1	SBK7801Z-11/16
3/4 in	11,70	1	SBK7801Z-3/4
13/16 in	11,87	1	SBK7801Z-13/16
7/8 in	11,87	1	SBK7801Z-7/8
15/16 in	13,80	1	SBK7801Z-15/16
1 in	14,35	1	SBK7801Z-1
1 1/16 in	15,47	1	SBK7801Z-1.1/16
1 1/8 in	16,40	1	SBK7801Z-1.1/8
1 1/4 in	26,96	1	SBK7801Z-1.1/4
1 5/16 in	31,19	1	SBK7801Z-1.5/16
1 3/8 in	31,19	1	SBK7801Z-1.3/8
1 7/16 in	31,19	1	SBK7801Z-1.7/16
1 1/2 in	35,73	1	SBK7801Z-1.1/2

Vaso de impacto largo 1/2" hexagonal en pulgadas, con acabado fosfatado



**SBK7806Z**

Ø	€		
3/8 in	14,83	10	SBK7806Z-3/8
7/16 in	14,83	10	SBK7806Z-7/16
1/2 in	14,83	10	SBK7806Z-1/2
9/16 in	14,83	10	SBK7806Z-9/16
5/8 in	14,99	5	SBK7806Z-5/8
11/16 in	14,99	1	SBK7806Z-11/16
3/4 in	15,04	1	SBK7806Z-3/4
13/16 in	15,04	1	SBK7806Z-13/16
7/8 in	15,04	1	SBK7806Z-7/8
15/16 in	15,50	1	SBK7806Z-15/16
1 in	16,88	1	SBK7806Z-1
1 1/16 in	17,98	1	SBK7806Z-1.1/16
1 1/8 in	20,26	5	SBK7806Z-1.1/8
1 1/4 in	31,00	1	SBK7806Z-1.1/4
1 5/16 in	35,91	1	SBK7806Z-1.5/16
1 3/8 in	35,91	5	SBK7806Z-1.3/8
1 7/16 in	35,91	5	SBK7806Z-1.7/16
1 1/2 in	41,16	1	SBK7806Z-1.1/2

Vaso de impacto 1/2" con punta TORX®



**7994S**

Ø	€		
T20	21,75	1	7994S0200
T25	22,43	1	7994S0250
T27	23,12	1	7994S0270
T-30	23,76	1	7994S0300
T-40	23,76	1	7994S0400
T-45	23,76	1	7994S0450
T-50	23,76	1	7994S0500
T-55	25,13	1	7994S0550
T-60	27,80	1	7994S0600
T-70	27,81	1	7994S0700

\* Hasta agotar existencias





Vaso de impacto TORX® hembras 1/2"



**K7801TORX-E**

	€		
E10	14,04	1	K7801TORX-E10
E12	14,04	1	K7801TORX-E12
E14	14,04	1	K7801TORX-E14
E16	14,04	1	K7801TORX-E16
E18	14,04	1	K7801TORX-E18
E20	15,21	1	K7801TORX-E20
E24	15,21	1	K7801TORX-E24

Articulación universal de impacto cardan 1/2"



**K8167S**

	€		
1/2"	35,68	1	K8167S

Muelle de fijación



**K560F-4/5**

	€		
1/2"	3,56	5	K560F-4
1/2"	3,56	5	K560F-5

Adaptador portapuntas, macho, 1/2"



**7807H-7809H**

	€		
1/2"	35,07	1	7807H
1/2"	35,07	1	7808H
1/2"	33,24	1	7809H
1/2"	48,62	1	SB7807H
1/2"	48,62	1	SB7808H
1/2"	53,84	1	SB7809H

SB: Embalaje en blister

Amplificador de entrada 1/2" a salida 3/4"



**K7764D/SBK7764D**

	€		
M 3/8"	24,74	1	K7764D
M 3/8"	23,62	1	SBK7764D

SB: Embalaje en blister

Juego de vasos de impacto extra cortos, 1/2"



**K7800M/13**

	€		
13	83,78	1	K7800M/13

K7800M-10, K7800M-11, K7800M-12, K7800M-13, K7800M-14, K7800M-15, K7800M-16, K7800M-17, K7800M-18, K7800M-19, K7800M-21, K7800M-22, K7800M-24

47501B-A5

Alargadera de impacto 1/2"



**K8160D**

	€		
75 mm	14,52	1	K8160D-1
125 mm	17,88	1	K8160D-2
250 mm	28,34	1	K8160D-3
75 mm	15,30	1	SBK8160D-1
125 mm	18,64	1	SBK8160D-2
250 mm	29,11	1	SBK8160D-3

SB: Embalaje en blister

Adaptador de accionamiento de 1/2" a 3/4" con acabado fosfatado



**K8964D/SBK8964D**

	€		
3/4"	17,09	1	K8964D
M 3/4"	12,11	1	SBK8964D

SB: Embalaje en blister con información del producto

Juego de vasos de impacto 1/2", serie larga



**K7806M/S4**

	€		
4	52,78	1	K7806M/S4

K7806M-19, K7806M-22, K7806M-17, K7806M-24

47501B-A5



Juego de vasos de impacto cuadrado de 1/2", pulgadas



**K7801Z/10**

		€		
10	60 x 220 x 280 mm	116,84	1	K7801Z/10

K7801Z-7/16, K7801Z-1/2, K7801Z-11/16, K7801Z-5/8, K7801Z-13/16, K7801Z-3/4, K7801Z-15/16, K7801Z-7/8, K7801Z-1, K7801Z-9/16

Juego de vasos de impacto serie larga cuadrado de 1/2", pulgadas



**K7806Z/10**

		€		
10	60 x 220 x 280 mm	145,61	1	K7806Z/10

K7806Z-7/16, K7806Z-1/2, K7806Z-9/16, K7806Z-3/4, K7806Z-13/16, K7806Z-11/16, K7806Z-1, K7806Z-7/8, K7806Z-15/16, K7806Z-5/8

Juego de 14 vasos de impacto 1/2", serie larga, mm



**DD/S14**

	€		
14	99,67	4	DD/S14

K7806M-10, K7806M-11, K7806M-12, K7806M-13, K7806M-14, K7806M-15, K7806M-16, K7806M-17, K7806M-18, K7806M-19, K7806M-21, K7806M-22, K7806M-24, K7806M-27



Juego de 20 vasos de impacto (10 standar y 10 largos), serie larga



**D-DD/**

	€		
20	97,59	4	D-DD/S20

K7801M-10, K7801M-11, K7801M-12, K7801M-13, K7801M-14, K7801M-15, K7801M-16, K7801M-17, K7801M-18, K7801M-19



K7806M-10, K7806M-11, K7806M-12, K7806M-13, K7806M-14, K7806M-16, K7806M-17, K7806M-18, K7806M-19



Juego de 10 vasos de impacto cuadrado 1/2"



**D/**

	€		
10	63,10	6	D/S10

K7801M-10, K7801M-11, K7801M-12, K7801M-13, K7801M-14, K7801M-15, K7801M-16, K7801M-17, K7801M-18, K7801M-19



Juego de 14 vasos de impacto 1/2"



**D/S14**

	€		
14	86,22	6	D/S14

K7801M-10, K7801M-11, K7801M-12, K7801M-13, K7801M-14, K7801M-15, K7801M-16, K7801M-17, K7801M-18, K7801M-19, K7801M-21, K7801M-22, K7801M-24, K7801M-27



Juego de 10 vasos de impacto, serie larga, mm



**DD/**

	€		
10	62,14	6	DD/S10

K7806M-10, K7806M-11, K7806M-12, K7806M-13, K7806M-14, K7806M-15, K7806M-16, K7806M-17, K7806M-18, K7806M-19



Vaso de impacto 3/4", hexagonal, mm



**K8901M**

Ø	€		
17 mm	23,87	1	K8901M-17
18 mm	23,84	1	K8901M-18
19 mm	23,87	1	K8901M-19
21 mm	23,96	1	K8901M-21
22 mm	23,96	1	K8901M-22
23 mm	23,96	1	K8901M-23
24 mm	24,87	1	K8901M-24
27 mm	26,25	1	K8901M-27
28 mm	27,46	1	K8901M-28
29 mm	30,78	1	K8901M-29
30 mm	33,64	1	K8901M-30
32 mm	33,54	1	K8901M-32
33 mm	34,39	1	K8901M-33
34 mm	34,36	1	K8901M-34
36 mm	36,24	1	K8901M-36
38 mm	37,83	1	K8901M-38
41 mm	44,98	1	K8901M-41
46 mm	45,68	1	K8901M-46
50 mm	74,85	1	K8901M-50
55 mm	90,21	1	K8901M-55
60 mm	105,88	1	K8901M-60

Ø	€		
41 mm	25,36	1	SBK8901M-41
46 mm	29,27	1	SBK8901M-46
55 mm	40,92	1	SBK8901M-55
60 mm	46,31	1	SBK8901M-60
50 mm	34,08	1	SBK8901M-50

SB: Embalaje en blister con información del producto

Vaso de impacto 3/4", serie larga, hexagonal, mm



**K8906M**

Ø	€		
17 mm	44,01	1	K8906M-17
19 mm	45,02	1	K8906M-19
21 mm	45,76	1	K8906M-21
22 mm	45,76	1	K8906M-22
24 mm	46,49	1	K8906M-24
27 mm	48,25	1	K8906M-27
30 mm	49,26	1	K8906M-30
32 mm	52,47	1	K8906M-32
33 mm	53,22	1	K8906M-33
34 mm	56,05	1	K8906M-34
36 mm	57,99	1	K8906M-36
41 mm	60,49	1	K8906M-41
42 mm	43,97	1	K8906M-42
46 mm	69,61	1	K8906M-46

Ø	€		
1 5/8 in	44,50	1	K8901Z-1.5/8
1 11/16 in	48,31	1	K8901Z-1.11/16
1 3/4 in	52,95	1	K8901Z-1.3/4
1 13/16 in	47,74	1	K8901Z-1.13/16
1 7/8 in	61,30	1	K8901Z-1.7/8
1 15/16 in	67,76	1	K8901Z-1.15/16
2 in	67,76	1	K8901Z-2
2 1/16 in	76,81	1	K8901Z-2.1/16
2 3/16 in	85,08	1	K8901Z-2.3/16
2 1/4 in	89,21	1	K8901Z-2.1/4
2 3/8 in	95,86	1	K8901Z-2.3/8

SB: Embalaje en blister con información del producto

Vasos de impacto 3/4" serie larga, pulgadas



**K8906Z**

Ø	€		
3/4 in	48,09	1	K8906Z-3/4
13/16 in	48,09	1	K8906Z-13/16
7/8 in	48,09	1	K8906Z-7/8
15/16 in	48,09	1	K8906Z-15/16
1 mm	48,09	1	K8906Z-1
1 1/16 in	48,09	1	K8906Z-1.1/16
1.1/8 in	48,09	1	K8906Z-1.1/8
1.1/4 in	50,01	1	K8906Z-1.1/4
1.5/16 in	57,13	1	K8906Z-1.5/16
1.3/8 in	57,68	1	K8906Z-1.3/8
1.7/16 in	57,68	1	K8906Z-1.7/16
1.1/2 in	59,46	1	K8906Z-1.1/2
1.5/8 in	59,46	1	K8906Z-1.5/8
1.3/4 in	72,04	1	K8906Z-1.3/4
2 mm	108,82	1	K8906Z-2

Vasos de impacto 3/4", mm



**SBK8901M**

Ø	€		
17 mm	18,14	1	SBK8901M-17
18 mm	18,14	1	SBK8901M-18
19 mm	17,85	1	SBK8901M-19
21 mm	17,85	1	SBK8901M-21
22 mm	17,85	1	SBK8901M-22
23 mm	18,14	1	SBK8901M-23
24 mm	17,85	1	SBK8901M-24
27 mm	17,85	1	SBK8901M-27
28 mm	18,24	1	SBK8901M-28
29 mm	18,52	1	SBK8901M-29
30 mm	18,90	1	SBK8901M-30
32 mm	19,57	1	SBK8901M-32
33 mm	20,58	1	SBK8901M-33
34 mm	20,78	1	SBK8901M-34
36 mm	21,83	1	SBK8901M-36
38 mm	22,63	1	SBK8901M-38

Vasos de impacto 3/4", hexagonal, pulgadas



**K8901Z**

Ø	€		
11/16 in	28,62	1	K8901Z-11/16
3/4 in	28,62	1	K8901Z-3/4
13/16 in	28,62	1	K8901Z-13/16
7/8 in	28,62	1	K8901Z-7/8
15/16 in	28,62	1	K8901Z-15/16
1 in	29,94	1	K8901Z-1
1 1/16 in	29,94	1	K8901Z-1.1/16
1 1/8 in	29,94	1	K8901Z-1.1/8
1 3/16 in	29,94	1	K8901Z-1.3/16
1 1/4 in	30,66	1	K8901Z-1.1/4
1 5/16 in	30,66	1	K8901Z-1.5/16
1 3/8 in	31,48	1	K8901Z-1.3/8
1 7/16 in	31,48	1	K8901Z-1.7/16
1 1/2 in	40,36	1	K8901Z-1.1/2
1 9/16 in	37,84	1	K8901Z-1.9/16

Vaso de impacto 3/4" con punta hexagonal



**7993T**

Ø	€		
12 mm	55,21	1	7993T0120
14 mm	60,68	1	7993T0140
17 mm	60,68	1	7993T0170
19 mm	60,68	1	7993T0190
22 mm	72,59	1	7993T0220
24 mm	72,59	1	7993T0240

Adaptador portapuntas de impacto 3/4", hexágono de 22 mm



**K8909H**

		€		
22 mm	3/4"	62,78	1	K8909H-5

Articulación universal de impacto cardan 3/4"



**K8967S**

		€		
3/4"	3/4"	94,78	1	K8967S

Reductor/Amplificador de impacto de entrada 3/4"



**K8164F**

		€		
1/2"	3/4"	34,69	1	K8164F

Este producto no está garantizado contra la rotura del cuadrado macho

Adaptador de aumento de 3/4" a 1" con acabado fosfatado



**K9564F**

		€		
1"	3/4"	38,46	1	K9564F

Extensión de impacto 3/4"



**K8960F**

	€		
175 mm	47,32	1	K8960F-2
250 mm	56,80	1	K8960F-3
325 mm	61,55	1	K8960F-4

Muelle de fijación



**K560F-6**

		€		
3/4"	17-46 mm	4,05	5	K560F-6

Juego de 8 llaves de vaso de impacto 3/4" mm



**K8901M/8**

		€		
8	65 x 240 x 350 mm	245,23	1	K8901M/8

K8901M-27, K8901M-24, K8901M-21, K8901M-22, K8901M-30, K8901M-32, K8901M-36, K8901M-41

Juego de 8 vasos de impacto 3/4" serie larga, mm



**K8906M/8**

		€		
8	80 x 250 x 315 mm	381,39	1	K8906M/8

K8906M-24, K8906M-27, K8906M-30, K8906M-41, K8906M-36, K8906M-21, K8906M-22, K8906M-32



Juego de 8 llaves de vaso de impacto de 3/4", pulgadas



### K8901Z/8

8	80 x 250 x 310 mm	254,50	1	K8901Z/8
---	-------------------	--------	---	----------

K8901Z-1.1/16, K8901Z-1, K8901Z-1.3/8, K8901Z-1.5/16, K8901Z-1.1/4, K8901Z-1.1/2, K8901Z-1.7/16, K8901Z-1.1/8

Juego de vasos de impacto 3/4", pulgadas



### K8901Z/18

18	100 x 210 x 595 mm	532,05	1	K8901Z/18
----	--------------------	--------	---	-----------

K8901Z-11/16, K8901Z-3/4, K8901Z-13/16, K8901Z-7/8, K8901Z-15/16, K8901Z-1, K8901Z-1.1/16, K8901Z-1.1/8, K8901Z-1.3/16, K8901Z-1.1/4, K8901Z-1.5/16, K8901Z-1.3/8, K8901Z-1.7/16, K8901Z-1.1/2, K8901Z-1.9/16, K8901Z-1.5/8, K8901Z-1.11/16, K8901Z-1.3/4

Juego de 8 vasos de impacto 3/4" serie larga, pulgadas



### K8906Z/8

8	125 x 250 x 110 mm	426,21	1	K8906Z/8
---	--------------------	--------	---	----------

K8906Z-1, K8906Z-1.1/16, K8906Z-1.1/8, K8906Z-1.1/4, K8906Z-1.5/16, K8906Z-1.3/8, K8906Z-1.7/16, K8906Z-1.1/2

Vaso de impacto 1", hexagonal, mm



### K9501M

Ø	€		
22 mm	44,67	1	K9501M-22
24 mm	44,67	1	K9501M-24
27 mm	46,07	1	K9501M-27
30 mm	47,34	1	K9501M-30
32 mm	49,71	1	K9501M-32
33 mm	51,13	1	K9501M-33
34 mm	52,72	1	K9501M-34
36 mm	52,72	1	K9501M-36
38 mm	53,13	1	K9501M-38
41 mm	59,86	1	K9501M-41
42 mm	70,52	1	K9501M-42
46 mm	73,62	1	K9501M-46
50 mm	82,05	1	K9501M-50
55 mm	93,94	1	K9501M-55
60 mm	114,42	1	K9501M-60
65 mm	136,92	1	K9501M-65
70 mm	156,12	1	K9501M-70
75 mm	163,24	1	K9501M-75
80 mm	171,83	1	K9501M-80
85 mm	269,84	1	K9501M-85

Vaso de impacto 1", serie larga, hexagonal, mm



### K9506M

Ø	€		
22 mm	74,26	1	K9506M-22
24 mm	74,26	1	K9506M-24
27 mm	74,26	1	K9506M-27
30 mm	74,99	1	K9506M-30
32 mm	77,07	1	K9506M-32
33 mm	78,13	1	K9506M-33
34 mm	80,20	1	K9506M-34
36 mm	80,20	1	K9506M-36
38 mm	81,71	1	K9506M-38
41 mm	90,20	1	K9506M-41
46 mm	98,11	1	K9506M-46
50 mm	119,24	1	K9506M-50
55 mm	145,19	1	K9506M-55
60 mm	177,43	1	K9506M-60

Vasos de impacto 1", hexagonal, pulgadas



### K9501Z

Ø	€		
1 in	45,13	1	K9501Z-1
1 1/16 in	45,13	1	K9501Z-1.1/16
1 1/8 in	45,13	1	K9501Z-1.1/8
1 3/16 in	45,13	1	K9501Z-1.3/16
1 1/4 in	45,13	1	K9501Z-1.1/4
1 5/16 in	50,20	1	K9501Z-1.5/16
1 3/8 in	56,20	1	K9501Z-1.3/8
1 7/16 in	56,20	1	K9501Z-1.7/16
1 1/2 in	57,59	1	K9501Z-1.1/2
1 9/16 in	57,59	1	K9501Z-1.9/16
1 5/8 in	61,61	1	K9501Z-1.5/8
1 11/16 in	70,85	1	K9501Z-1.11/16
1 3/4 in	70,85	1	K9501Z-1.3/4
1 13/16 in	77,10	1	K9501Z-1.13/16
1 7/8 in	77,10	1	K9501Z-1.7/8
1 5/16 in	79,86	1	K9501Z-1.15/16
2 in	90,33	1	K9501Z-2
2 1/8 in	101,50	1	K9501Z-2.1/8
2 3/16 in	101,50	1	K9501Z-2.3/16
2 1/4 in	110,26	1	K9501Z-2.1/4
2 5/16 in	110,26	1	K9501Z-2.5/16
2 9/16 in	152,07	1	K9501Z-2.9/16
2 3/4 in	159,72	1	K9501Z-2.3/4



Vasos de impacto 1", serie larga, pulgadas



**K9506Z**

Ø	€	Icon	Icon
1 in	66,44	1	K9506Z-1
1 1/16 in	67,49	1	K9506Z-1.1/16
1 3/16 in	67,49	1	K9506Z-1.3/16
1 1/4 in	67,70	1	K9506Z-1.1/4
1 7/16 in	67,70	1	K9506Z-1.7/16
1 1/2 in	69,97	1	K9506Z-1.1/2
1 5/8 in	75,62	1	K9506Z-1.5/8
1 13/16 in	96,94	1	K9506Z-1.13/16
1 7/8 in	109,33	1	K9506Z-1.7/8

Adaptador portapuntas de impacto, hexágono de 22 mm



**K9509H5**

Ø	Icon	€	Icon	Icon
22 mm	1"	100,07	1	K9509H5

Llave de vaso de impacto 1" punta hexagonal



**7993M**

Ø	€	Icon	Icon
17 mm	110,12	1	7993M0170
19 mm	110,12	1	7993M0190
22 mm	125,30	1	7993M0220
27 mm	127,11	1	7993M0270

Reductor/Amplificador de impacto de entrada 1"



**K8964G**

Icon	Icon	€	Icon	Icon
3/4"	1"	36,82	1	K8964G

Este producto no está garantizado contra la rotura del cuadrado macho

Adaptador de accionamiento cuadrado de 1" a 1-1/2" con acabado fosfatado



**K9895G**

Icon	Icon	€	Icon	Icon
1 1/2"	1"	180,79	1	K9895G

Extensión de impacto 1"



**K9560G**

Icon	€	Icon	Icon
100 mm	57,13	1	K9560G-0
125 mm	62,39	1	K9560G-1
175 mm	68,25	1	K9560G-2
325 mm	64,01	1	K9560G-3
300 mm	68,48	1	K9560G-4
400 mm	83,70	1	K9560G-5

Articulación universal de impacto cardan 1"



**K9567S**

Icon	Icon	€	Icon	Icon
1"	1"	199,11	1	K9567S

Punta de atornillador mm



**K8909ML/K9509ML**

Icon	€	Icon	Icon
12 mm	18,84	1	K8909ML-12
14 mm	18,84	1	K8909ML-14
17 mm	18,84	1	K8909ML-17
19 mm	19,33	1	K9509ML-19
22 mm	25,35	1	K9509ML-22
24 mm	25,42	1	K9509ML-24

Muelle de fijación



**K560F-7/8**

Icon	Icon	€	Icon	Icon
1"	19-70 mm	4,57	5	K560F-7
1 & 1 1/2"	75-80 & 46-90 mm	5,99	5	K560F-8





Vasos de impacto 1.1/2"



**K9801M**

Ø	€		
46 mm	208,42	1	K9801M-46
50 mm	208,42	1	K9801M-50
55 mm	220,73	1	K9801M-55
60 mm	245,11	1	K9801M-60
65 mm	266,63	1	K9801M-65
70 mm	287,95	1	K9801M-70
75 mm	312,42	1	K9801M-75
80 mm	342,97	1	K9801M-80
85 mm	394,08	1	K9801M-85
90 mm	436,95	1	K9801M-90
95 mm	516,34	1	K9801M-95
100 mm	554,50	1	K9801M-100
105 mm	600,36	1	K9801M-105
110 mm	758,27	1	K9801M-110
115 mm	799,71	1	K9801M-115
120 mm	860,96	1	K9801M-120
125 mm	888,71	1	K9801M-125
130 mm	987,46	1	K9801M-130
135 mm	1.086,20	1	K9801M-135
140 mm	1.135,58	1	K9801M-140
145 mm	1.250,78	1	K9801M-145
150 mm	1.481,21	1	K9801M-150
155 mm	1.678,68	1	K9801M-155

Vasos de impacto 1.1/2", pulgadas



**K9801Z**

Ø	€		
1 3/8 in	132,63	1	K9801Z-1.3/8
1 7/16 in	132,22	1	K9801Z-1.7/16
1 1/2 in	132,22	1	K9801Z-1.1/2
1 9/16 in	136,44	1	K9801Z-1.9/16
1 5/8 in	135,09	1	K9801Z-1.5/8
1 11/16 in	135,09	1	K9801Z-1.11/16
1 3/4 in	142,27	1	K9801Z-1.3/4
1 13/16 in	142,27	1	K9801Z-1.13/16
1 7/8 in	142,27	1	K9801Z-1.7/8
1 15/16 in	142,27	1	K9801Z-1.15/16
2 in	142,27	1	K9801Z-2
2 1/16 in	143,66	1	K9801Z-2.1/16
2 1/8 in	145,41	1	K9801Z-2.1/8
2 3/16 in	147,83	1	K9801Z-2.3/16
2 1/4 in	164,16	1	K9801Z-2.1/4
2 5/16 in	177,65	1	K9801Z-2.5/16
2 3/8 in	195,03	1	K9801Z-2.3/8
2 7/16 in	196,97	1	K9801Z-2.7/16
2 1/2 in	196,22	1	K9801Z-2.1/2
2 9/16 in	205,20	1	K9801Z-2.9/16
2 5/8 in	212,50	1	K9801Z-2.5/8
2 11/16 in	226,66	1	K9801Z-2.11/16
2 3/4 in	248,07	1	K9801Z-2.3/4
2 13/16 in	213,66	1	K9801Z-2.13/16
2 7/8 in	270,62	1	K9801Z-2.7/8
2 15/16 in	288,45	1	K9801Z-2.15/16
3 in	303,17	1	K9801Z-3
3 1/16 in	330,36	1	K9801Z-3.1/16
3 1/8 in	347,03	1	K9801Z-3.1/8
3 1/4 in	343,86	1	K9801Z-3.1/4
3 5/16 in	353,57	1	K9801Z-3.5/16
3 3/8 in	367,17	1	K9801Z-3.3/8
3 7/16 in	378,97	1	K9801Z-3.7/16
3 1/2 in	382,73	1	K9801Z-3.1/2
3 9/16 in	429,43	1	K9801Z-3.9/16
3 5/8 in	502,41	1	K9801Z-3.5/8
3 11/16 in	588,29	1	K9801Z-3.11/16
3 3/4 in	575,21	1	K9801Z-3.3/4
3 13/16 in	572,18	1	K9801Z-3.13/16
3 7/8 in	675,04	1	K9801Z-3.7/8
3 15/16 in	675,80	1	K9801Z-3.15/16
4 in	684,94	1	K9801Z-4
4 1/16 in	692,94	1	K9801Z-4.1/16
4 1/8 in	719,37	1	K9801Z-4.1/8
4 1/4 in	735,53	1	K9801Z-4.1/4
4 5/16 in	783,07	1	K9801Z-4.5/16
4 3/8 in	830,05	1	K9801Z-4.3/8
4 7/16 in	849,22	1	K9801Z-4.7/16
4 1/2 in	869,25	1	K9801Z-4.1/2
4 5/8 in	889,20	1	K9801Z-4.5/8
4 3/4 in	1.065,32	1	K9801Z-4.3/4

Vasos de impacto profundos 1.1/2", pulgadas



**K9806Z**

Ø	€		
1 3/8 in	198,00	1	K9806Z-1.3/8
1 7/16 in	199,49	1	K9806Z-1.7/16
1 1/2 in	197,55	1	K9806Z-1.1/2
1 5/8 in	199,49	1	K9806Z-1.5/8
1 11/16 in	199,49	1	K9806Z-1.11/16
2 in	209,13	1	K9806Z-2
2 1/16 in	209,13	1	K9806Z-2.1/16
2 3/16 in	226,54	1	K9806Z-2.3/16
2 1/4 in	235,55	1	K9806Z-2.1/4
2 5/16 in	240,62	1	K9806Z-2.5/16
2 3/8 in	289,27	1	K9806Z-2.3/8
2 7/16 in	290,42	1	K9806Z-2.7/16
2 1/2 in	294,53	1	K9806Z-2.1/2
2 9/16 in	296,19	1	K9806Z-2.9/16
2 5/8 in	357,95	1	K9806Z-2.5/8
2 11/16 in	364,14	1	K9806Z-2.11/16
2 3/4 in	380,12	1	K9806Z-2.3/4
2 13/16 in	397,35	1	K9806Z-2.13/16
2 7/8 in	419,77	1	K9806Z-2.7/8
2 15/16 in	425,05	1	K9806Z-2.15/16
3 in	457,19	1	K9806Z-3
3 1/16 in	480,97	1	K9806Z-3.1/16
3 1/8 in	505,37	1	K9806Z-3.1/8
3 3/16 in	514,03	1	K9806Z-3.3/16
3 1/4 in	541,88	1	K9806Z-3.1/4
3 5/16 in	541,92	1	K9806Z-3.5/16
3 3/8 in	562,71	1	K9806Z-3.3/8
3 7/16 in	586,60	1	K9806Z-3.7/16
3 1/2 in	586,60	1	K9806Z-3.1/2
3 9/16 in	626,15	1	K9806Z-3.9/16
3 5/8 in	616,64	1	K9806Z-3.5/8
3 11/16 in	781,90	1	K9806Z-3.11/16
3 3/4 in	804,18	1	K9806Z-3.3/4
3 13/16 in	781,90	1	K9806Z-3.13/16
3 7/8 in	866,50	1	K9806Z-3.7/8
3 15/16 in	844,31	1	K9806Z-3.15/16
4 in	853,41	1	K9806Z-4
4 1/16 in	832,58	1	K9806Z-4.1/16
4 1/8 in	1.044,61	1	K9806Z-4.1/8
4 1/4 in	1.079,23	1	K9806Z-4.1/4
4 5/16 in	1.200,02	1	K9806Z-4.5/16
4 3/8 in	1.294,00	1	K9806Z-4.3/8
4 1/2 in	1.339,34	1	K9806Z-4.1/2
4 5/8 in	1.372,64	1	K9806Z-4.5/8
4 3/4 in	1.464,69	1	K9806Z-4.3/4

Vasos de impacto profundos 1.1/2", mm



**K9806M**

Ø	€		
41 mm	425,81	1	K9806M-41
46 mm	425,81	1	K9806M-46
50 mm	425,81	1	K9806M-50
55 mm	425,81	1	K9806M-55
60 mm	436,07	1	K9806M-60
65 mm	483,62	1	K9806M-65
70 mm	543,76	1	K9806M-70
75 mm	608,13	1	K9806M-75
80 mm	735,52	1	K9806M-80
85 mm	740,10	1	K9806M-85
90 mm	781,52	1	K9806M-90
95 mm	920,02	1	K9806M-95
100 mm	1.002,59	1	K9806M-100
105 mm	1.102,01	1	K9806M-105
110 mm	1.406,98	1	K9806M-110
115 mm	1.567,09	1	K9806M-115
120 mm	3.009,47	1	K9806M-120

Articulación universal de impacto cardan 1.1/2"



**K9867S**

		€		
1 1/2	1 1/2	674,06	1	K9867S

Adaptador de accionamiento cuadrado de 1,1/2" a 2,1/2" con acabado fosfatado



**K9998H**

		€		
2 1/2	1 1/2	960,26	1	K9998H

Alargadera de impacto 1.1/2"



**K9860H**

	€		
255 mm	429,36	1	K9860H-1
380 mm	473,61	1	K9860H-2
510 mm	477,78	1	K9860H-3

Adaptador reductor de accionamiento cuadrado de 2,1/2" a 1,1/2" con acabado fosfatado



**K9899H**

		€		
1 1/2	2 1/2	1.259,01	1	K9899H

Adaptador de impacto



**K9598H**

		€		
1	1 1/2	282,48	1	K9598H

Muelle de fijación



**K560F-9**

		€		
1 1/2"	95-120 mm	7,09	5	K560F-9





**BAHCO®**



# Destornilladores





# DESTORNILLADORES ERGO™ CON MANGO TRI-COMPONENTE

Juego 5 destornilladores ERGO™



**BE-9885**

	€		
5	41,72	1	BE-9885

BE-8910, BE-8930, BE-8915, BE-8920, BE-8925

Juego 6 destornilladores ERGO™



**BE-9881**

	€		
6	43,68	1	BE-9881

BE-8020, BE-8040  
BE-8150, BE-8155  
BE-8620, BE-8610

Juego 6 destornilladores ERGO™



**BE-9882**

	€		
6	45,45	1	BE-9882

**BAHCO**

BE-8020, BE-8040  
BE-8155, BE-8150  
BE-8810, BE-8820

Juego 6 destornilladores ERGO™



**BE-9884**

	€		
6	47,37	1	BE-9884

BE-8611, BE-8621  
BE-8040, BE-8241  
BE-8811, BE-8821

Juego 6 destornilladores ERGO™



**BE-9886**

	€		
6	46,29	1	BE-9886

BE-8030  
BE-8150  
BE-8621, BE-8611  
BE-8821, BE-8811

Juego 6 destornilladores ERGO™



ergo®



**BE-9871**

	€		
6	46,36	1	BE-9871

BE-8220S		
BE-8920, BE-8925		
BE-8820		
BE-8611, BE-8620		

Juego de destornilladores ranurados/Phillips/Pozidriv/TORX® ERGO™ con mango de goma (8 piezas)



ergo®



**BE-9872**

			€		
8	45 x 170 x 340 mm	595 g	77,00	1	BE-9872

BE-8925, BE-8920, BE-8915		
BE-8030		
BE-8821, BE-8811		
BE-8621, BE-8611		

Juego 13 destornilladores ERGO™



ergo®



**BE-9875**

	€		
13	103,26	1	BE-9875

BE-8040		
BE-8150, BE-8155		
BE-8621		
BE-8811, BE-8821		
BE-8910, BE-8915, BE-8920, BE-8925		
BE-8010S, BE-8230S		
BE-8811S		

Juego 13 destornilladores Ergo™



ergo®



**BE-9879**

	€		
13	83,41	1	BE-9879

BE-8010, BE-8040		
BE-8150		
BE-8611, BE-8621		
BE-8811, BE-8821		
BE-8910, BE-8915, BE-8920, BE-8925		
BE-8220SL		
BE-8620SL		



Juego 15 destornilladores ERGO™



ergo



**BE-9877**

	€		
15	111,91	1	BE-9877

BE-8030		
BE-8150		
BE-8611, BE-8621		
BE-8811, BE-8821		
BE-8910, BE-8915, BE-8920, BE-8925		
BE-8220S, BE-8040S, BE-8050S		
BE-8611S, BE-8621S		

Destornillador ERGO™ plano



ergo



**BE-8002 - BE-8252**



				€		
2.0 mm	60 mm	17 mm	103 mm	4,03	5	BE-8002
2.5 mm	60 mm	17 mm	103 mm	4,16	5	BE-8010
2.5 mm	75 mm	17 mm	103 mm	4,47	5	BE-8210
3.0 mm	60 mm	17 mm	103 mm	5,91	5	BE-8020
3.0 mm	75 mm	17 mm	103 mm	4,60	5	BE-8020L
3.0 mm	100 mm	17 mm	103 mm	4,95	5	BE-8022
3.0 mm	125 mm	17 mm	103 mm	6,72	5	BE-8220
3.0 mm	200 mm	17 mm	103 mm	7,93	5	BE-8225
3.5 mm	75 mm	17 mm	103 mm	5,09	5	BE-8030
3.5 mm	125 mm	17 mm	103 mm	6,40	5	BE-8230
3.5 mm	200 mm	17 mm	103 mm	8,17	5	BE-8235
4.0 mm	100 mm	20 mm	122 mm	5,82	5	BE-8040
4.0 mm	175 mm	20 mm	122 mm	9,56	5	BE-8240
5.5 mm	125 mm	27 mm	122 mm	8,10	5	BE-8241
5.5 mm	150 mm	27 mm	122 mm	9,05	5	BE-8242
5.5 mm	200 mm	27 mm	122 mm	12,24	5	BE-8250L
6.0 mm	150 mm	36 mm	122 mm	9,89	5	BE-8251
6.5 mm	150 mm	36 mm	122 mm	10,68	5	BE-8252

Destornillador ERGO™ plano para tornillos ranurados



ergo



**BE-8150 - BE-8258**



				€		
5.5 mm	100 mm	27 mm	122 mm	7,97	5	BE-8150
5.5 mm	150 mm	27 mm	122 mm	10,95	5	BE-8250
6.5 mm	125 mm	36 mm	122 mm	10,00	5	BE-8155
6.5 mm	150 mm	36 mm	122 mm	11,36	5	BE-8255
8 mm	150 mm	36 mm	122 mm	12,48	5	BE-8256
8 mm	175 mm	36 mm	122 mm	12,82	5	BE-8257
10 mm	200 mm	36 mm	161 mm	16,85	5	BE-8258

Destornillador ERGO™ plano



ergo



**BE-8158 - BE-8890**



				€		
5.5 mm	125 mm	27 mm	122 mm	12,92	5	BE-8158
6.5 mm	150 mm	36 mm	122 mm	15,19	5	BE-8159
8 mm	125 mm	36 mm	122 mm	14,82	5	BE-8160
8 mm	175 mm	36 mm	122 mm	17,22	5	BE-8260
8 mm	175 mm	36 mm	161 mm	17,60	5	BE-8865
10 mm	175 mm	36 mm	161 mm	18,95	5	BE-8870
12 mm	200 mm	36 mm	161 mm	24,19	5	BE-8880
14 mm	200 mm	36 mm	161 mm	30,59	5	BE-8890

Destornillador ERGO™ plano stubby



ergo



**BE-8330 - BE-8360**



				€		
3.5 mm	25 mm	36 mm	58 mm	5,45	5	BE-8330
4.0 mm	25 mm	36 mm	58 mm	5,82	5	BE-8340
5.0 mm	25 mm	36 mm	58 mm	7,47	5	BE-8350

Ø	L	l	l	€	Icon	Icon
5.0 mm	45 mm	36 mm	58 mm	<b>8,06</b>	5	BE-8450
6.5 mm	25 mm	36 mm	58 mm	<b>7,81</b>	5	BE-8355
6.0 mm	45 mm	36 mm	58 mm	<b>9,34</b>	5	BE-8455
8.0 mm	25 mm	36 mm	58 mm	<b>8,96</b>	5	BE-8360

### Destornillador ERGO™ phillips



### BE-8600 - BE-8624



Icon	L	l	l	€	Icon	Icon
PH 0	60 mm	17 mm	103 mm	<b>6,15</b>	5	BE-8600
PH 0	100 mm	17 mm	103 mm	<b>6,31</b>	5	BE-8605
PH 0	200 mm	17 mm	103 mm	<b>8,86</b>	5	BE-8608
PH 1	75 mm	27 mm	122 mm	<b>7,55</b>	5	BE-8610
PH 1	75 mm	20 mm	122 mm	<b>7,46</b>	5	BE-8611
PH 1	* 200 mm	27 mm	122 mm	<b>11,30</b>	5	BE-8610L
PH 2	100 mm	36 mm	122 mm	<b>8,44</b>	5	BE-8620
PH 2	100 mm	27 mm	122 mm	<b>8,28</b>	5	BE-8621
PH 2	150 mm	36 mm	122 mm	<b>9,41</b>	5	BE-8622
PH 2	* 200 mm	36 mm	122 mm	<b>14,21</b>	5	BE-8620L
PH 3	150 mm	36 mm	122 mm	<b>14,45</b>	5	BE-8623
PH 4	200 mm	36 mm	161 mm	<b>20,01</b>	5	BE-8624

### Destornillador ERGO™ phillips



### BE-8628 - BE-8640



Icon	L	l	l	€	Icon	Icon
PH 1	100 mm	27 mm	122 mm	<b>10,02</b>	5	BE-8628
PH 2	125 mm	36 mm	122 mm	<b>12,72</b>	5	BE-8629
PH 3	150 mm	36 mm	122 mm	<b>17,42</b>	5	BE-8630
PH 4	200 mm	36 mm	161 mm	<b>23,20</b>	5	BE-8640

### Destornillador ERGO™ Phillips Stubby



### BE-8601/BE-8602



Icon	L	l	l	€	Icon	Icon
PH 1	25 mm	36 mm	58 mm	<b>8,08</b>	5	BE-8601
PH 2	25 mm	36 mm	58 mm	<b>8,08</b>	5	BE-8602

### Destornillador ERGO™ Torx



### BE-8800 - BE-8824



Icon	L	l	l	€	Icon	Icon
PZ 0	60 mm	17 mm	103 mm	<b>7,33</b>	5	BE-8800
PZ 1	75 mm	27 mm	122 mm	<b>8,20</b>	5	BE-8810
PZ 1	75 mm	20 mm	122 mm	<b>7,46</b>	5	BE-8811
PZ 1	200 mm	27 mm	122 mm	<b>9,54</b>	5	BE-8810L
PZ 2	100 mm	36 mm	122 mm	<b>10,00</b>	5	BE-8820
PZ 2	100 mm	27 mm	122 mm	<b>16,86</b>	5	BE-8821
PZ 2	200 mm	36 mm	122 mm	<b>20,35</b>	5	BE-8820L
PZ 3	150 mm	36 mm	122 mm	<b>15,21</b>	5	BE-8823
PZ 4	200 mm	36 mm	161 mm	<b>21,22</b>	5	BE-8824

### Destornillador ERGO™ Pozidriv



### BE-8828 - BE-8840



Icon	L	l	l	€	Icon	Icon
PZ 1	100 mm	27 mm	122 mm	<b>12,29</b>	5	BE-8828
PZ 2	125 mm	36 mm	122 mm	<b>15,80</b>	5	BE-8829
PZ 3	150 mm	36 mm	122 mm	<b>15,25</b>	5	BE-8830
PZ 4	200 mm	36 mm	161 mm	<b>19,96</b>	5	BE-8840



Destornillador ERGO™ Pozidriv Stubby



**BE-8801/BE-8802**



					€		
PZ 1	25 mm	36 mm	58 mm		8,27	5	BE-8801
PZ 2	25 mm	36 mm	58 mm		8,27	5	BE-8802

Destornillador ERGO™ Torx



**BE-8904 - BE-8945**



					€		
T 4	75 mm	17 mm	103 mm		7,74	5	BE-8904
T 5	75 mm	17 mm	103 mm		7,74	5	BE-8905
T 6	75 mm	17 mm	103 mm		7,81	5	BE-8906
T 7	75 mm	17 mm	103 mm		7,86	5	BE-8907
T 8	75 mm	17 mm	103 mm		7,89	5	BE-8908
T 9	75 mm	17 mm	103 mm		7,92	5	BE-8909
T 10	75 mm	20 mm	122 mm		7,93	5	BE-8910
T 15	100 mm	27 mm	122 mm		8,10	5	BE-8915
T 20	100 mm	27 mm	122 mm		8,20	5	BE-8920
T 25	125 mm	27 mm	122 mm		8,74	5	BE-8925
T 27	125 mm	27 mm	122 mm		8,97	5	BE-8927
T30	150 mm	36 mm	122 mm		10,72	5	BE-8930
T40	150 mm	36 mm	161 mm		12,93	5	BE-8940
T45	150 mm	36 mm	161 mm		13,89	5	BE-8945

Destornillador ERGO™ Torx



**BE-7907 - BE-7940**



					€		
TR 7	75 mm	17 mm	103 mm		10,87	5	BE-7907
TR 8	75 mm	17 mm	103 mm		10,91	5	BE-7908
TR 9	75 mm	17 mm	103 mm		10,94	5	BE-7909

**BAHCO**

					€		
TR 10	75 mm	20 mm	122 mm		10,98	5	BE-7910
TR 15	100 mm	27 mm	122 mm		11,05	5	BE-7915
TR 20	100 mm	27 mm	122 mm		11,11	5	BE-7920
TR 25	125 mm	27 mm	122 mm		11,57	5	BE-7925
TR 27	125 mm	27 mm	122 mm		11,74	5	BE-7927
TR 30	150 mm	36 mm	122 mm		13,37	5	BE-7930
TR 40	150 mm	36 mm	161 mm		15,63	5	BE-7940

Destornillador ERGO™ TORX® bola



**BE-7515 - BE-7540**



					€		
T 15	100 mm	27 mm	122 mm		8,49	5	BE-7515
T 20	100 mm	27 mm	122 mm		8,68	5	BE-7520
T 25	125 mm	27 mm	122 mm		9,18	5	BE-7525
T 27	125 mm	27 mm	122 mm		9,97	5	BE-7527
T 30	150 mm	36 mm	122 mm		10,70	5	BE-7530
T 40	150 mm	36 mm	122 mm		11,88	5	BE-7540

Destornillador ERGO™ Torx



**BE-7715 - BE-7740**



					€		
T 15	100 mm	27 mm	122 mm		10,61	5	BE-7715
T 20	100 mm	27 mm	122 mm		10,68	5	BE-7720
T 25	125 mm	27 mm	122 mm		11,02	5	BE-7725
T 27	125 mm	27 mm	122 mm		11,15	5	BE-7727
T 30	150 mm	36 mm	122 mm		11,57	5	BE-7730
T 40	150 mm	36 mm	122 mm		11,83	5	BE-7740



### Destornillador ERGO™ Torx



ergo



#### BE-6902 - BE-6903

					€		
2 mm	75 mm	17 mm	103 mm	<b>4,31</b>	5	BE-6902	
2.5 mm	75 mm	17 mm	103 mm	<b>4,38</b>	5	BE-6925	
3 mm	75 mm	20 mm	122 mm	<b>4,86</b>	5	BE-6903	

### Destornillador ERGO™ hexagonal con bola



ergo



#### BE-8715 - BE-8710

					€		
1.5 mm	60 mm	17 mm	103 mm	<b>5,08</b>	5	BE-8715	
2 mm	100 mm	17 mm	103 mm	<b>5,26</b>	5	BE-8702	
2.5 mm	100 mm	17 mm	103 mm	<b>5,38</b>	5	BE-8725	
3 mm	100 mm	20 mm	122 mm	<b>5,45</b>	5	BE-8703	
4 mm	100 mm	27 mm	122 mm	<b>6,20</b>	5	BE-8704	
5 mm	100 mm	36 mm	122 mm	<b>7,69</b>	5	BE-8705	
6 mm	125 mm	36 mm	122 mm	<b>8,84</b>	5	BE-8706	
8 mm	150 mm	36 mm	122 mm	<b>12,65</b>	5	BE-8708	
10 mm	150 mm	36 mm	161 mm	<b>14,28</b>	5	BE-8710	

### Destornillador ERGO™ hexagonal con bola, pulgadas



ergo



#### BE-8700-7/64 - BE-8700-5/16

					€		
7/64 in	100 mm	20 mm	122 mm	<b>9,14</b>	5	BE-8700-7/64	
5/32 in	100 mm	27 mm	122 mm	<b>6,42</b>	5	BE-8700-5/32	
3/16 in	100 mm	27 mm	122 mm	<b>8,22</b>	5	BE-8700-3/16	
7/32 in	100 mm	36 mm	122 mm	<b>8,84</b>	5	BE-8700-7/32	
1/4 in	125 mm	36 mm	122 mm	<b>10,36</b>	5	BE-8700-1/4	
5/16 in	150 mm	36 mm	122 mm	<b>14,63</b>	5	BE-8700-5/16	
3/8 in	150 mm	36 mm	161 mm	<b>18,70</b>	5	BE-8700-3/8	

### Destornillador ERGO™ Robertson



ergo



#### BE-9001 - BE-9003

					€		
# 1	80 mm	27 mm	122 mm	<b>9,08</b>	5	BE-9001	
# 2	80 mm	27 mm	122 mm	<b>9,76</b>	5	BE-9002	
# 3	100 mm	27 mm	122 mm	<b>10,17</b>	5	BE-9003	

### Destornillador ERGO™ para tornillos TRI-WING®



ergo



#### BE-9100 - BE-9105

					€		
0	80 mm	20 mm	122 mm	<b>9,63</b>	5	BE-9100	
1	80 mm	20 mm	122 mm	<b>9,63</b>	5	BE-9101	
2	80 mm	27 mm	122 mm	<b>9,63</b>	5	BE-9102	
3	80 mm	27 mm	122 mm	<b>9,63</b>	5	BE-9103	
4	100 mm	27 mm	122 mm	<b>11,05</b>	5	BE-9104	
5	100 mm	27 mm	122 mm	<b>11,05</b>	5	BE-9105	

### Destornillador ERGO™ TORQ-SET®



ergo



#### BE-8080

					€		
1	75 mm	27 mm	122 mm	<b>15,66</b>	5	BE-8080-1	
2	75 mm	27 mm	122 mm	<b>16,13</b>	5	BE-8080-2	
3	75 mm	27 mm	122 mm	<b>16,13</b>	5	BE-8080-3	
4	75 mm	27 mm	122 mm	<b>16,13</b>	5	BE-8080-4	
5	75 mm	27 mm	122 mm	<b>16,13</b>	5	BE-8080-5	
6	75 mm	27 mm	122 mm	<b>16,13</b>	5	BE-8080-6	
8	100 mm	27 mm	122 mm	<b>22,28</b>	5	BE-8080-8	
10	100 mm	27 mm	122 mm	<b>22,28</b>	5	BE-8080-10	



Mango ERGO™, puntero



ergo



**BE-8985**

				€		
6 mm	100 mm	27 mm	122 mm	8,68	5	BE-8985

Punzón ERGO™



ergo



**BE-8986**

				€		
4 mm	36 mm	50 mm	58 mm	9,03	5	BE-8986

Mango ERGO™, puntero



ergo



**BE-8980**

				€		
6 mm	100 mm	27 mm	122 mm	9,14	5	BE-8980

Destornillador stecker ERGO™



ergo



**BE-6400M**

				€		
4 mm	75 mm	20 mm	122 mm	12,58	5	BE-6400M-4
5 mm	75 mm	20 mm	122 mm	13,28	5	BE-6400M-5
5.5 mm	75 mm	20 mm	122 mm	13,28	5	BE-6400M-5.5
7 mm	75 mm	20 mm	122 mm	14,57	5	BE-6400M-7

Destornillador stecker ERGO™, con boca larga



ergo



**BE-78**

				€		
3 mm	125 mm	20 mm	122 mm	12,58	5	BE-7803
3.5 mm	125 mm	20 mm	122 mm	12,58	5	BE-7835
4 mm	125 mm	20 mm	122 mm	12,58	5	BE-7804
4.5 mm	125 mm	20 mm	122 mm	12,58	5	BE-7845
5 mm	125 mm	20 mm	122 mm	13,28	5	BE-7805
5.5 mm	125 mm	20 mm	122 mm	13,28	5	BE-7855
6 mm	125 mm	20 mm	122 mm	13,89	5	BE-7806
7 mm	125 mm	27 mm	122 mm	14,57	5	BE-7807
8 mm	125 mm	27 mm	122 mm	17,54	5	BE-7808
9 mm	125 mm	36 mm	122 mm	17,88	5	BE-7809
10 mm	125 mm	36 mm	122 mm	18,40	5	BE-7810
11 mm	125 mm	36 mm	122 mm	18,92	5	BE-7811
12 mm	125 mm	36 mm	122 mm	21,35	5	BE-7812
13 mm	125 mm	36 mm	161 mm	22,05	5	BE-7813
14 mm	125 mm	36 mm	161 mm	23,97	5	BE-7814

Destornillador stecker ERGO™, varilla flexible



ergo®



**BE-76**

Ø	L	L <sub>1</sub>	L <sub>2</sub>	€	Icon	Icon
6 mm	150 mm	27 mm	122 mm	20,62	5	BE-7606
7 mm	150 mm	27 mm	122 mm	20,91	5	BE-7607
8 mm	150 mm	27 mm	122 mm	22,32	5	BE-7608

Portapuntas ERGO™ hexágono hembra 1/4"



ergo®



**BE-8577**

Ø	L	L <sub>1</sub>	L <sub>2</sub>	€	Icon	Icon
1/4 in	118 mm	36 mm	122 mm	15,80	5	BE-8577

Mango destornillador multivarilla hexágono 1/4"



ergo®



**BE-8575**

Ø	L	€	Icon	Icon
1/4 in	122 mm	20,52	1	BE-8575

Pack 2 varillas hex 1/4" para tornillos planos, 100 mm



**8020-2P - 8252-2P**

Ø	L	€	Icon	Icon
3.0 mm	0.5 mm	9,04	1	8020-2P
3.5 mm	0.6 mm	9,04	1	8030-2P
4.0 mm	0.8 mm	9,04	1	8040-2P
5.5 mm	1.0 mm	9,14	1	8242-2P
6.5 mm	1.2 mm	9,14	1	8252-2P

Pack 2 varillas hex 1/4" para tornillos Philips, 100 mm



**8600-2P - 8630-2P**

Ø	L	€	Icon	Icon
0		8,98	1	8600-2P
1		8,98	1	8610-2P
2		9,04	1	8620-2P
3		9,04	1	8630-2P

Pack 2 varillas hex 1/4" para tornillos Pozidriv, 100 mm



**8800-2P - 8830-2P**

Ø	L	€	Icon	Icon
0		8,98	1	8800-2P
1		8,98	1	8810-2P
2		9,04	1	8820-2P
3		9,04	1	8830-2P



Pack 2 varillas hex para tornillos TORX®. 100mm



**8910-2P - 8940-2P**

	€		
10	8,98	1	8910-2P
15	8,98	1	8915-2P
20	9,04	1	8920-2P
25	9,04	1	8925-2P
27	9,04	1	8927-2P
30	9,14	1	8930-2P
40	9,14	1	8940-2P

Pack 2 varillas hex 1/4" para tornillos Philips, 300mm



**8610L-2P - 8620L-2P**

	€		
1	12,71	1	8610L-2P
2	12,71	1	8620L-2P

Pack de 2 varillas 1/4" hexagonales con punta hexagonal, 100mm



**8703-2P - 8706-2P**

	€		
3 mm	9,26	1	8703-2P
4 mm	9,26	1	8704-2P
5 mm	9,26	1	8705-2P
6 mm	9,26	1	8706-2P

Pack 2 varillas hex 1/4" para tornillos Pozidriv, 300mm



**8810L-2P - 8820L-2P**

	€		
1	12,71	1	8810L-2P
2	12,71	1	8820L-2P

Varilla hexagonal 1/4" para tornillos TORX®, 300mm



Pack 2 varillas hex 1/4" para tornillos ranurados, 300mm



**8040L-2P - 8252L-2P**

		€		
0.8 mm	4.0 mm	12,91	1	8040L-2P
1.0 mm	5.5 mm	12,91	1	8242L-2P
1.2 mm	6.5 mm	12,91	1	8252L-2P

**8915L-2P - 8930L-2P**

	€		
T15	13,75	1	8915L-2P
T20	13,75	1	8920L-2P
T25	13,75	1	8925L-2P
T27	13,75	1	8927L-2P
T30	13,75	1	8930L-2P

Varilla hexagonal 1/4" para tornillos de cabeza Phillips, 400mm



**8620XL-1P - 8630XL-1P**



	€		
2	11,56	1	8620XL-1P
3	11,56	1	8630XL-1P

Varilla hexagonal 1/4" para tornillos de cabeza Pozidriv, 400mm



**8820XL-1P - 8830XL-1P**



	€		
2	11,56	1	8820XL-1P
3	11,56	1	8830XL-1P

Varilla hexagonal 1/4" para tornillos de cabeza plana, 400mm



**8252XL-1P**



	€		
1.2 mm	11,56	1	8252XL-1P

Juego destornillador con 6 varillas intercambiables ERGO™



**BE-8571**

	€		
7	65,50	1	BE-8571

BE-8575		
8242-2P, 8252-2P		
8610-2P, 8620-2P		
8810-2P, 8820-2P		

Juego destornillador con 8 varillas intercambiables ERGO™



**BE-8572**

	€		
9	69,46	1	BE-8572

BE-8575		
8242-2P, 8252-2P		
8610-2P, 8620-2P		
8810-2P, 8820-2P		
8910-2P, 8915-2P		





Juego destornillador con 7 varillas intercambiables TORX® ERGO™



ergo



**BE-8573**



		€		
8	85 x 85 x 210 mm	67,50	1	BE-8573

<b>BE-8575</b>		
8910-2P, 8915-2P, 8920-2P, 8925-2P, 8927-2P, 8930-2P, 8940-2P		

Juego destornilladores ERGO™ con varillas intercambiables, 7 piezas



ergo



**BE-8574**

		€		
8	85 x 85 x 210 mm	68,07	1	BE-8574

<b>BE-8575</b>		
8610-2P, 8620-2P		
8040-2P		
8820-2P		
8920-2P, 8925-2P, 8930-2P		

Foam con 22 piezas con mango intercambiable, 16 varillas y 6 puntas ERGO™



ergo



**BE-8576**

	€		
23	134,38	1	BE-8576

<b>BE-8575</b>		
8030-2P, 8040-2P, 8242-2P, 8252-2P		
8810-2P, 8820-2P, 8830-2P		
8610-2P, 8620-2P, 8630-2P		
8910-2P, 8915-2P, 8925-2P, 8930-2P, 8940-2P		
59S/H2, 59S/H3, 59S/H5, 59S/H4, 59S/H6		
59S/H8		

**DESTORNILLADORES ERGO™ CON MANGO DE IMPACTO**

Juego de 6 destornilladores de varilla pasante ERGO™



ergo



**BE-9881TB**

	€		
6	58,40	1	BE-9881TB

<b>BE-8135TB, BE-8145TB, BE-8150TB, BE-8155TB</b>		
<b>BE-8610TB, BE-8620TB</b>		

Juego de 6 destornilladores de varilla pasante ERGO™



ergo®



**BE-9882TB**

	€		
6	61,17	1	BE-9882TB

BE-8135TB, BE-8145TB, BE-8150TB, BE-8155TB



BE-8810TB, BE-8820TB



Juego de 5 destornilladores ERGO™ varilla pasante



ergo®



**BE-9885TB**

	€		
5	53,80	1	BE-9885TB

BE-8915TB, BE-8920TB, BE-8925TB, BE-8930TB, BE-8940TB



Destornillador de varilla pasante ERGO™



ergo®



**BE-8135TB - BE-8262TB**

				€		
3.5 mm	75 mm	27 mm	122 mm	8,78	10	BE-8135TB
4.5 mm	100 mm	27 mm	122 mm	11,56	10	BE-8145TB
5.5 mm	100 mm	27 mm	122 mm	13,37	10	BE-8150TB

				€		
6.5 mm	125 mm	36 mm	122 mm	15,71	10	BE-8155TB
8 mm	150 mm	36 mm	122 mm	20,80	10	BE-8256TB
10 mm	175 mm	36 mm	122 mm	25,07	10	BE-8258TB
12 mm	200 mm	36 mm	122 mm	30,11	10	BE-8262TB
3.5 mm	75 mm	27 mm	122 mm	9,42	1	SBE-8135TB
4.5 mm	100 mm	27 mm	122 mm	12,18	1	SBE-8145TB
5.5 mm	100 mm	27 mm	122 mm	14,00	1	SBE-8150TB
6.5 mm	125 mm	36 mm	122 mm	16,36	1	SBE-8155TB

SB: Presentación en clip

Destornillador ERGO™ varilla hexagonal, pasante



ergo®



**BE-8610TB - BE-8624TB**

				€		
PH 1	100 mm	27 mm	122 mm	14,24	10	BE-8610TB
PH 2	125 mm	36 mm	122 mm	15,81	10	BE-8620TB
PH 3	150 mm	36 mm	122 mm	21,07	10	BE-8623TB
PH 4	175 mm	36 mm	122 mm	30,67	10	BE-8624TB
PH 1	100 mm	27 mm	122 mm	14,88	1	SBE-8610TB
PH 2	125 mm	36 mm	122 mm	16,45	1	SBE-8620TB

SB: Presentación en clip

Destornillador ERGO™ varilla hexagonal, pasante



ergo®



**BE-8810TB - BE-8824TB**

				€		
PZ 1	100 mm	27 mm	122 mm	12,77	10	BE-8810TB
PZ 2	125 mm	36 mm	122 mm	18,09	10	BE-8820TB
PZ 3	150 mm	36 mm	122 mm	23,68	10	BE-8823TB
PZ 4	175 mm	36 mm	122 mm	33,01	10	BE-8824TB
PZ 1	100 mm	27 mm	122 mm	13,41	1	SBE-8810TB
PZ 2	125 mm	36 mm	122 mm	18,72	1	SBE-8820TB

SBE: Presentación en clip



Destornillador ERGO™ varilla hexagonal, pasante



**BE-8910TB - BE-8940TB**

					€		
T 10	75 mm	27 mm	122 mm	<b>8,27</b>	5	BE-8910TB	
T 15	100 mm	27 mm	122 mm	<b>11,22</b>	5	BE-8915TB	
T 20	100 mm	27 mm	122 mm	<b>11,41</b>	5	BE-8920TB	
T 25	100 mm	27 mm	122 mm	<b>12,13</b>	5	BE-8925TB	
T 27	125 mm	27 mm	122 mm	<b>13,27</b>	5	BE-8927TB	
T 30	150 mm	36 mm	122 mm	<b>13,94</b>	5	BE-8930TB	
T 40	150 mm	36 mm	122 mm	<b>15,74</b>	5	BE-8940TB	
T 15	100 mm	27 mm	122 mm	<b>11,85</b>	1	SBE-8915TB	
T 20	100 mm	27 mm	122 mm	<b>12,04</b>	1	SBE-8920TB	
T 25	100 mm	27 mm	122 mm	<b>12,76</b>	1	SBE-8925TB	
T 30	150 mm	36 mm	122 mm	<b>14,56</b>	1	SBE-8930TB	
T 40	150 mm	36 mm	122 mm	<b>16,37</b>	1	SBE-8940TB	

SB: Presentación en clip

**DESTORNILLADORES BAHCOFIT CON MANGO BI-MATERIAL**

Juego 2 destornilladores BahcoFit



**B219.002**



		€		
2	X	10,35	1	B219.002

B191.040.100

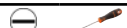

B192.001.100

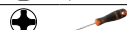

Juego 2 destornilladores BahcoFit



**B219.012**



		€		
2	X	13,05	1	B219.012



B190.055.125



B192.002.125



Juego 4 destornilladores BahcoFit PL/PH



**B219.004**



		€		
4	X	24,01	1	B219.004

B191.030.100, B191.055.125



B192.001.100, B192.002.125



Juego de destornilladores Phillips BahcoFit con mango de goma - 4 piezas



**B219.014**



		€		
4	X	28,33	1	B219.014

B192.000.075, B192.001.100, B192.002.125, B192.003.150



Juego 5 destornilladores BahcoFit PL/RECTA/PH



**B219.005**



	€		
5	28,02	1	B219.005

B194.010.075, B194.015.100, B194.020.100, B194.025.125, B194.030.150



Juego 5 destornilladores BahcoFit TORX inviolable



**B219.035**



	€		
5	38,82	1	B219.035

B141.010.075, B141.015.100, B141.020.100, B141.025.125, B141.030.150



Juego 5 destornilladores BahcoFit PL/RECTA/PZ



**B219.015**



	€		
5	27,50	1	B219.015

B191.030.075, B191.040.100



B190.055.125



B193.001.100, B193.002.125



Juego 5 destornilladores BahcoFit TORX



**B219.025**



	€		
5	31,31	1	B219.025

Juego de 5 destornilladores BahcoFit punta plana



**B219.045**



	€		
5	33,11	1	B219.045

B191.030.100, B191.040.125



B190.055.125, B190.065.150, B190.080.175



Juego 6 destornilladores BahcoFit PL/RECTA/PH



**B219.006**



	€		
6	32,81	1	B219.006

B191.030.075, B191.040.100		
B190.055.125, B190.065.125		
B192.001.100, B192.002.125		

Juego 6 destornilladores BahcoFit PL/RECTA/PZ



**B219.016**



	€		
6	33,51	1	B219.016

B191.030.075, B191.040.100		
B190.055.125, B190.065.125		
B193.001.100, B193.002.125		

Juego 6 destornilladores BahcoFit RECTA/PH/PZ



**B219.026**



	€		
6	34,74	1	B219.026

**BAHCO®**

B191.030.075, B191.040.100		
B192.001.100, B192.002.125		
B193.001.100, B193.002.125		

Juego 7 destornilladores BahcoFit POZI/TORX



**B219.007**



	€		
7	43,87	1	B219.007

B193.001.100, B193.002.125		
B194.010.075, B194.015.100, B194.020.100, B194.025.125, B194.030.150		

Juego 7 destornilladores BahcoFit PLANA/RECTA/PH



**B219.017**



	€		
7	41,89	1	B219.017

B191.035.100, B191.040.100		
B190.055.125, B190.065.150, B190.080.150		
B192.001.100, B192.002.125		



Juego 7 destornilladores Bahcofit punta Phillips



**B219.027**



€ 45,35 1 B219.027

B194.010.075, B194.015.100, B194.020.100, B194.025.125,  
B194.027.125, B194.030.150, B194.040.150



Juego 8 destornilladores BahcoFit PL/RECTA/PH/EXTRACORTO PH,PZ



**B219.008**



€ 53,17 1 B219.008

B191.040.100, B191.055.125



B190.065.150, B190.080.175



B192.001.100, B192.002.125



B195.060.025

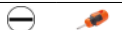

B195.002.025



Juego de 10 destornilladores BahcoFit



**B219.110**



€ 63,40 1 B219.110

B190.055.100



B192.002.125



B193.002.125



B194.010.075, B194.015.100, B194.020.100



B196.025.075, B196.040.100



B142.001.080



806-1-1



Juego de 10 destornilladores BahcoFit raurados/Phillips/Pozidriv/Robertson



**B219.210**



4.5 x 33 x 17 mm € 62,05 1 B219.210

B194.006.075, B194.008.075, B194.009.075, B194.010.075,  
B194.015.100, B194.020.100, B194.025.125, B194.027.125,  
B194.030.150, B194.040.150



## Juego 10 destornilladores BahcoFit RECTA/PL/PH/PZ/ROBERTSON



### B219.010

X		€	SB	SB
10		55,85	1	B219.010

B191.030.075	
B190.055.100, B190.065.125, B190.080.150	
B192.001.100, B192.002.125, B192.003.150	
B195.902.025	
B144.001.100, B144.002.125	

## Destornillador Boca Plana BahcoFit



### B190

Bit	Shank	Tip	Length	€	SB	SB
4 mm	75 mm	24.5 mm	95 mm	4,86	10	B190.040.075
4 mm	100 mm	24.5 mm	95 mm	4,91	10	B190.040.100
5.5 mm	100 mm	30 mm	105 mm	6,22	10	B190.055.100
5.5 mm	125 mm	30 mm	105 mm	6,34	10	B190.055.125
6.5 mm	125 mm	34 mm	117 mm	7,80	10	B190.065.125
6.5 mm	150 mm	34 mm	117 mm	8,88	10	B190.065.150
8 mm	150 mm	34 mm	117 mm	9,75	10	B190.080.150
8 mm	175 mm	34 mm	117 mm	10,02	10	B190.080.175
10 mm	200 mm	34 mm	117 mm	13,15	10	B190.100.200
12 mm	250 mm	34 mm	117 mm	17,08	10	B190.120.250
14 mm	250 mm	34 mm	117 mm	18,19	10	B190.140.250
4 mm	75 mm	24.5 mm	95 mm	5,61	1	SB190.040.075
4 mm	100 mm	24.5 mm	95 mm	5,68	1	SB190.040.100
5.5 mm	100 mm	30 mm	105 mm	6,98	1	SB190.055.100
5.5 mm	125 mm	30 mm	105 mm	7,12	1	SB190.055.125
6.5 mm	125 mm	34 mm	117 mm	8,59	1	SB190.065.125
6.5 mm	150 mm	34 mm	117 mm	9,65	1	SB190.065.150
8 mm	150 mm	34 mm	117 mm	10,52	1	SB190.080.150
8 mm	175 mm	34 mm	117 mm	10,78	1	SB190.080.175
10 mm	200 mm	34 mm	117 mm	13,94	1	SB190.100.200
12 mm	250 mm	34 mm	117 mm	17,86	1	SB190.120.250
14 mm	250 mm	34 mm	117 mm	18,97	1	SB190.140.250

SB: Presentación en clip

## Destornillador Boca Recta BahcoFit



### B191

Bit	Shank	Tip	Length	€	SB	SB
2.5 mm	75 mm	24.5 mm	95 mm	3,50	10	B191.025.075
3 mm	75 mm	24.5 mm	95 mm	3,61	10	B191.030.075
3 mm	100 mm	24.5 mm	95 mm	3,86	10	B191.030.100
3 mm	200 mm	24.5 mm	95 mm	6,20	10	B191.030.200
3.5 mm	100 mm	24.5 mm	95 mm	3,98	10	B191.035.100
4 mm	100 mm	24.5 mm	95 mm	4,55	10	B191.040.100
4 mm	125 mm	24.5 mm	95 mm	5,00	10	B191.040.125
4 mm	250 mm	24.5 mm	95 mm	7,47	10	B191.040.250
5.5 mm	125 mm	30 mm	105 mm	6,32	10	B191.055.125
5.5 mm	150 mm	30 mm	105 mm	7,08	10	B191.055.150
5.5 mm	300 mm	30 mm	105 mm	9,55	10	B191.055.300
6.5 mm	150 mm	34 mm	117 mm	8,34	10	B191.065.150
6.5 mm	300 mm	34 mm	117 mm	10,95	10	B191.065.300
2.5 mm	75 mm	24.5 mm	95 mm	4,25	1	SB191.025.075
3 mm	75 mm	24.5 mm	95 mm	4,37	1	SB191.030.075
3 mm	100 mm	24.5 mm	95 mm	4,64	1	SB191.030.100
3 mm	200 mm	24.5 mm	95 mm	6,96	1	SB191.030.200
3.5 mm	100 mm	24.5 mm	95 mm	4,77	1	SB191.035.100
4 mm	100 mm	24.5 mm	95 mm	5,30	1	SB191.040.100
4 mm	125 mm	24.5 mm	95 mm	5,77	1	SB191.040.125
4 mm	250 mm	24.5 mm	95 mm	8,22	1	SB191.040.250
5.5 mm	125 mm	30 mm	105 mm	7,11	1	SB191.055.125
5.5 mm	150 mm	30 mm	105 mm	7,85	1	SB191.055.150
5.5 mm	300 mm	30 mm	105 mm	10,32	1	SB191.055.300
6.5 mm	150 mm	34 mm	117 mm	9,11	1	SB191.065.150
6.5 mm	300 mm	34 mm	117 mm	11,72	1	SB191.065.300

SB: Presentación en clip

## Destornillador BahcoFit boca plana carrocer



### B195

Bit	Shank	Tip	Length	€	SB	SB
4 mm	25 mm	33 mm	60 mm	4,55	10	B195.040.025
5.0 mm	25 mm	33 mm	60 mm	5,85	10	B195.050.025
6 mm	25 mm	33 mm	60 mm	6,11	10	B195.060.025
4 mm	25 mm	33 mm	60 mm	5,30	1	SB195.040.025
5 mm	25 mm	33 mm	60 mm	6,60	1	SB195.050.025
6 mm	25 mm	33 mm	60 mm	6,87	1	SB195.060.025

SB: Presentación en clip

## Destornillador Boca Phillips BahcoFit



### B192



				€		
PH0	75 mm	24.5 mm	95 mm	<b>4,80</b>	10	B192.000.075
PH0	200 mm	24.5 mm	95 mm	<b>6,91</b>	10	B192.000.200
PH1	100 mm	30 mm	105 mm	<b>5,89</b>	10	B192.001.100
PH1	250 mm	30 mm	105 mm	<b>8,82</b>	10	B192.001.250
PH2	125 mm	34 mm	117 mm	<b>7,33</b>	10	B192.002.125
PH2	150 mm	34 mm	117 mm	<b>7,74</b>	10	B192.002.150
PH2	300 mm	34 mm	117 mm	<b>11,10</b>	10	B192.002.300
PH3	150 mm	34 mm	117 mm	<b>11,29</b>	10	B192.003.150
PH4	200 mm	34 mm	117 mm	<b>15,63</b>	10	B192.004.200
PH0	75 mm	24.5 mm	95 mm	<b>5,57</b>	1	SB192.000.075
PH0	200 mm	24.5 mm	95 mm	<b>7,69</b>	1	SB192.000.200
PH1	100 mm	30 mm	105 mm	<b>6,66</b>	1	SB192.001.100
PH1	250 mm	30 mm	105 mm	<b>9,59</b>	1	SB192.001.250
PH2	125 mm	34 mm	117 mm	<b>8,11</b>	1	SB192.002.125
PH2	300 mm	34 mm	117 mm	<b>11,87</b>	1	SB192.002.300
PH3	150 mm	34 mm	117 mm	<b>12,05</b>	1	SB192.003.150
PH4	200 mm	34 mm	117 mm	<b>16,40</b>	1	SB192.004.200

SB: Presentación en clip

## Destornillador PH Mango Carrocero



### B195PH



				€		
PH1	25 mm	33 mm	60 mm	<b>6,11</b>	10	B195.001.025
PH2	25 mm	33 mm	60 mm	<b>6,11</b>	10	B195.002.025
PH1	25 mm	33 mm	60 mm	<b>6,87</b>	1	SB195.001.025
PH2	25 mm	33 mm	60 mm	<b>6,87</b>	1	SB195.002.025

SB: Presentación en clip

## Destornillador Boca Pozidriv BahcoFit



### B193



				€		
PZ0	75 mm	24.5 mm	95 mm	<b>5,71</b>	10	B193.000.075
PZ1	100 mm	30 mm	105 mm	<b>6,40</b>	10	B193.001.100
PZ2	125 mm	34 mm	117 mm	<b>7,80</b>	10	B193.002.125
PZ3	150 mm	34 mm	117 mm	<b>11,89</b>	10	B193.003.150
PZ4	200 mm	34 mm	117 mm	<b>16,56</b>	10	B193.004.200
PZ0	75 mm	24.5 mm	95 mm	<b>6,49</b>	1	SB193.000.075
PZ1	100 mm	30 mm	105 mm	<b>7,18</b>	1	SB193.001.100
PZ2	125 mm	34 mm	117 mm	<b>8,59</b>	1	SB193.002.125
PZ3	150 mm	34 mm	117 mm	<b>12,67</b>	1	SB193.003.150
PZ4	200 mm	34 mm	117 mm	<b>17,33</b>	1	SB193.004.200

SB: Presentación en clip

## Destornillador BahcoFit PZ, carrocerero



### B195PZ



				€		
PZ1	25 mm	33 mm	60 mm	<b>6,45</b>	10	B195.901.025
PZ2	25 mm	33 mm	60 mm	<b>6,87</b>	10	B195.902.025
PZ1	25 mm	33 mm	60 mm	<b>7,22</b>	1	SB195.901.025
PZ2	25 mm	33 mm	60 mm	<b>7,65</b>	1	SB195.902.025

SB: Presentación en clip



## Destornillador Boca Torx BahcoFit



### B194



					€		
T4	75 mm	24.5 mm	95 mm	<b>6,78</b>	10	B194.004.075	
T5	75 mm	24.5 mm	95 mm	<b>6,57</b>	10	B194.005.075	
T6	75 mm	24.5 mm	95 mm	<b>6,11</b>	10	B194.006.075	
T7	75 mm	24.5 mm	95 mm	<b>6,15</b>	10	B194.007.075	
T8	75 mm	24.5 mm	95 mm	<b>6,17</b>	10	B194.008.075	
T9	75 mm	24.5 mm	95 mm	<b>6,19</b>	10	B194.009.075	
T10	75 mm	24.5 mm	95 mm	<b>6,20</b>	10	B194.010.075	
T15	100 mm	24.5 mm	95 mm	<b>6,32</b>	10	B194.015.100	
T20	100 mm	24.5 mm	95 mm	<b>6,40</b>	10	B194.020.100	
T25	125 mm	30 mm	105 mm	<b>6,82</b>	10	B194.025.125	
T27	125 mm	30 mm	105 mm	<b>6,99</b>	10	B194.027.125	
T30	150 mm	34 mm	117 mm	<b>8,37</b>	10	B194.030.150	
T40	150 mm	34 mm	117 mm	<b>10,09</b>	10	B194.040.150	
T45	150 mm	34 mm	117 mm	<b>10,84</b>	5	B194.045.150	
T4	75 mm	24.5 mm	95 mm	<b>7,56</b>	1	SB194.004.075	
T5	75 mm	24.5 mm	95 mm	<b>7,37</b>	1	SB194.005.075	
T6	75 mm	24.5 mm	95 mm	<b>6,87</b>	1	SB194.006.075	
T7	75 mm	24.5 mm	95 mm	<b>6,90</b>	1	SB194.007.075	
T8	75 mm	24.5 mm	95 mm	<b>6,92</b>	1	SB194.008.075	
T9	75 mm	24.5 mm	95 mm	<b>6,95</b>	1	SB194.009.075	
T10	75 mm	24.5 mm	95 mm	<b>6,96</b>	1	SB194.010.075	
T15	100 mm	24.5 mm	95 mm	<b>7,11</b>	1	SB194.015.100	
T20	100 mm	24.5 mm	95 mm	<b>7,18</b>	1	SB194.020.100	
T25	125 mm	30 mm	105 mm	<b>7,60</b>	1	SB194.025.125	
T27	125 mm	30 mm	105 mm	<b>7,78</b>	1	SB194.027.125	
T30	150 mm	34 mm	117 mm	<b>9,15</b>	1	SB194.030.150	
T40	150 mm	34 mm	117 mm	<b>10,87</b>	1	SB194.040.150	
T45	150 mm	34 mm	117 mm	<b>11,61</b>	1	SB194.045.150	

SB: Presentación en clip

## Destornillador Torx Inviolable BahcoFit



### B141



					€		
TR7	75 mm	24.5 mm	95 mm	<b>8,49</b>	5	B141.007.075	
TR8	75 mm	24.5 mm	95 mm	<b>8,52</b>	5	B141.008.075	
TR9	75 mm	24.5 mm	95 mm	<b>8,56</b>	5	B141.009.075	
TR10	75 mm	24.5 mm	95 mm	<b>8,58</b>	5	B141.010.075	
TR15	100 mm	24.5 mm	95 mm	<b>8,65</b>	5	B141.015.100	
TR20	100 mm	24.5 mm	95 mm	<b>8,68</b>	5	B141.020.100	
TR25	125 mm	30 mm	105 mm	<b>9,03</b>	5	B141.025.125	
TR27	125 mm	30 mm	105 mm	<b>9,16</b>	5	B141.027.125	
TR30	150 mm	34 mm	117 mm	<b>10,44</b>	5	B141.030.150	
TR40	150 mm	34 mm	117 mm	<b>12,20</b>	5	B141.040.150	
TR7	75 mm	24.5 mm	95 mm	<b>9,26</b>	1	SB141.007.075	
TR8	75 mm	24.5 mm	95 mm	<b>9,29</b>	1	SB141.008.075	
TR9	75 mm	24.5 mm	95 mm	<b>9,31</b>	1	SB141.009.075	

**BAHCO**

					€		
TR10	75 mm	24.5 mm	95 mm	<b>9,34</b>	1	SB141.010.075	
TR15	100 mm	24.5 mm	95 mm	<b>9,40</b>	1	SB141.015.100	
TR20	100 mm	24.5 mm	95 mm	<b>9,45</b>	1	SB141.020.100	
TR25	125 mm	30 mm	105 mm	<b>9,82</b>	1	SB141.025.125	
TR27	125 mm	30 mm	105 mm	<b>9,95</b>	1	SB141.027.125	
TR30	150 mm	34 mm	117 mm	<b>11,23</b>	1	SB141.030.150	
TR40	150 mm	34 mm	117 mm	<b>12,98</b>	1	SB141.040.150	

SB: Presentación en clip

## Destornillador Hexagonal Bola BahcoFit



### B143



					€		
2	100 mm	24.5 mm	95 mm	<b>4,09</b>	5	B143.020.100	
2.5	100 mm	24.5 mm	95 mm	<b>4,19</b>	10	B143.025.100	
3	100 mm	24.5 mm	95 mm	<b>4,25</b>	10	B143.030.100	
4	100 mm	24.5 mm	95 mm	<b>4,94</b>	10	B143.040.100	
5	100 mm	30 mm	105 mm	<b>6,02</b>	10	B143.050.100	
6	125 mm	34 mm	117 mm	<b>6,90</b>	10	B143.060.125	
8	150 mm	34 mm	117 mm	<b>9,89</b>	5	B143.080.150	
2	100 mm	24.5 mm	95 mm	<b>4,89</b>	1	SB143.020.100	
2.5	100 mm	24.5 mm	95 mm	<b>4,97</b>	1	SB143.025.100	
3	100 mm	24.5 mm	95 mm	<b>5,03</b>	1	SB143.030.100	
4	100 mm	24.5 mm	95 mm	<b>5,60</b>	1	SB143.040.100	
5	100 mm	30 mm	105 mm	<b>6,78</b>	1	SB143.050.100	
6	125 mm	34 mm	117 mm	<b>7,68</b>	1	SB143.060.125	
8	150 mm	34 mm	117 mm	<b>10,65</b>	1	SB143.080.150	

SB: Presentación en clip

## Destornillador BahcoFit boca Robertson



### B144



					€		
#1	100 mm	24.5 mm	95 mm	<b>7,11</b>	5	B144.001.100	
#2	125 mm	30 mm	105 mm	<b>7,61</b>	5	B144.002.125	
#3	150 mm	34 mm	117 mm	<b>7,94</b>	5	B144.003.150	
#1	100 mm	24.5 mm	95 mm	<b>7,87</b>	1	SB144.001.100	
#2	125 mm	30 mm	105 mm	<b>8,39</b>	1	SB144.002.125	
#3	150 mm	34 mm	117 mm	<b>8,71</b>	1	SB144.003.150	

SB: Presentación en clip

Destornillador Puntero boca redonda BahcoFit



**B145**

Ø	L	l	l <sub>1</sub>	€	SB	Part
6 mm	100 mm	30 mm	105 mm	6,78	5	B145.006.100
6 mm	100 mm	30 mm	105 mm	7,56	1	SB145.006.100

SB: Presentación en clip

Destornillador BahcoFit Puntero boca cuadrada



**B146**

Ø	L	l	l <sub>1</sub>	€	SB	Part
6 mm	100 mm	30 mm	105 mm	7,13	5	B146.006.100
6 mm	100 mm	30 mm	105 mm	7,89	1	SB146.006.100

SB: Presentación en clip

Punzón carrocerero



**B195AwI**

Ø	L	l	l <sub>1</sub>	€	SB	Part
4 mm	50 mm	33 mm	60 mm	6,11	5	B195.006.050
4 mm	50 mm	33 mm	60 mm	6,87	1	SB195.006.050

SB: Presentación en clip

Destornillador Stecker BahcoFit



**B198**

Ø	L	l	l <sub>1</sub>	€	SB	Part
4 mm	125 mm	24.5 mm	95 mm	9,85	5	B198.040.125
4.5 mm	125 mm	24.5 mm	95 mm	9,85	5	B198.045.125
5 mm	150 mm	30 mm	105 mm	10,36	5	B198.050.150
5.5 mm	150 mm	30 mm	105 mm	10,36	5	B198.055.150
6 mm	150 mm	30 mm	105 mm	10,84	5	B198.060.150
7 mm	150 mm	34 mm	117 mm	11,38	5	B198.070.150
8 mm	150 mm	34 mm	117 mm	13,70	5	B198.080.150
9 mm	150 mm	34 mm	117 mm	13,97	5	B198.090.150
10 mm	150 mm	34 mm	117 mm	14,37	5	B198.100.150
11 mm	150 mm	34 mm	117 mm	14,77	5	B198.110.150
12 mm	150 mm	34 mm	117 mm	16,68	5	B198.120.150
13 mm	150 mm	34 mm	117 mm	17,07	5	B198.130.150
14 mm	150 mm	34 mm	117 mm	18,70	5	B198.140.150
4 mm	125 mm	24.5 mm	95 mm	10,59	1	SB198.040.125
4.5 mm	125 mm	24.5 mm	95 mm	10,59	1	SB198.045.125
5 mm	150 mm	30 mm	105 mm	11,15	1	SB198.050.150
5.5 mm	150 mm	30 mm	105 mm	11,15	1	SB198.055.150
6 mm	150 mm	30 mm	105 mm	11,61	1	SB198.060.150
7 mm	150 mm	34 mm	117 mm	12,15	1	SB198.070.150
8 mm	150 mm	34 mm	117 mm	14,46	1	SB198.080.150
9 mm	150 mm	34 mm	117 mm	14,74	1	SB198.090.150
10 mm	150 mm	34 mm	117 mm	15,15	1	SB198.100.150
11 mm	150 mm	34 mm	117 mm	15,55	1	SB198.110.150
12 mm	150 mm	34 mm	117 mm	17,47	1	SB198.120.150
13 mm	150 mm	34 mm	117 mm	17,98	1	SB198.130.150
14 mm	150 mm	34 mm	117 mm	19,48	1	SB198.140.150

SB: Presentación en clip





Destornillador BahcoFit de cabeza hexagonal y eje flexible con empuñadura de goma 6-8 mm



**B198F**

Head Size	Shaft Length	Head Length	Total Length	Price (€)	Quantity	Part Number
6 mm	150 mm	34 mm	117 mm	15,80	5	B198.060.150F
7 mm	150 mm	34 mm	117 mm	16,34	5	B198.070.150F
8 mm	150 mm	34 mm	117 mm	17,45	5	B198.080.150F
6 mm	150 mm	34 mm	117 mm	16,58	1	SB198.060.150F
7 mm	150 mm	34 mm	117 mm	17,09	1	SB198.070.150F
8 mm	150 mm	34 mm	117 mm	18,19	1	SB198.080.150F

SB: Presentación en clip

**DESTORNILLADORES CON MANGO DE GOMA**

Juego 3 destornilladores serie-600



**600-3**

3	€	13,23	1	600-3
---	---	-------	---	-------

613-3-100	+	-
611-5.5-125	+	-
615-1-100	+	+

Juego 4 destornilladores Serie 600



**602-4-LA**

4	€	18,64	1	602-4-LA
---	---	-------	---	----------

613-3-100	+	-
611-5.5-100	+	-
615-1-100, 615-2-125	+	+

Juego 5 destornilladores serie-600



**604-5**

5	€	24,77	1	604-5
---	---	-------	---	-------

613-3-100	+	-
611-4-100, 611-6.5-125	+	-
615-1-100, 615-2-125	+	+

Juego 5 destornilladores Serie 600



**612-5**



	€		
5	29,74	1	612-5

618-10-75, 618-15-100, 618-20-100, 618-25-125, 618-30-150



Juego 6 destornilladores Serie 600



**605-6**



	€		
6	30,11	1	605-6

613-3-75, 613-4-100



615-1-100, 615-2-125



616-1-100, 616-2-125



Juego 6 destornilladores Serie-600



**606-6**



	€		
6	29,13	1	606-6

611-5.5-100, 611-6.5-125



613-3-75, 613-4-100



615-1-100, 615-2-125



Juego 6 destornilladores Serie-600



**610-6**



	€		
6	29,96	1	610-6

611-5.5-100, 611-6.5-125



613-3-75, 613-4-100



616-1-100, 616-2-125



## Juego 10 destornilladores Serie 600



### 605-10-PC-AU



10

€

57,80



1 605-10-PC-AU

Incluye carroceros PZ2x25 y Robertson R1x100, R2x100

611-5.5-100, 611-6.5-125, 611-8-150

613-3-75

615-1-100, 615-2-125, 615-3-150

616-2-25, 619-1-100, 619-2-100

## Destornillador plano



### 611

Tip	Length	Shank	Blade	€	Qty	Code
3.5 mm	75 mm	25 mm	80 mm	3,20	10	611-3.5-75
3.5 mm	100 mm	25 mm	80 mm	3,36	10	611-3.5-100
4.0 mm	75 mm	25 mm	80 mm	3,83	10	611-4-75
4.0 mm	100 mm	25 mm	80 mm	4,27	10	611-4-100
5.5 mm	100 mm	30 mm	97 mm	5,10	10	611-5.5-100
5.5 mm	125 mm	30 mm	97 mm	5,38	10	611-5.5-125
6.5 mm	25 mm	35 mm	60 mm	6,48	10	611-6.5-25
6.5 mm	125 mm	35 mm	110 mm	6,50	10	611-6.5-125
6.5 mm	150 mm	35 mm	110 mm	6,81	10	611-6.5-150
8.0 mm	150 mm	35 mm	110 mm	8,26	10	611-8-150
8.0 mm	175 mm	35 mm	110 mm	8,74	10	611-8-175
10.0 mm	200 mm	35 mm	110 mm	10,56	10	611-10-200

## Destornillador punta recta



### 613

Tip	Length	Shank	Blade	€	Qty	Code
3.0 mm	75 mm	25 mm	80 mm	3,19	10	613-3-75
3.0 mm	100 mm	25 mm	80 mm	3,25	10	613-3-100
3.5 mm	100 mm	25 mm	80 mm	3,37	10	613-3.5-100
4.0 mm	100 mm	25 mm	80 mm	3,78	10	613-4-100
4.0 mm	125 mm	25 mm	80 mm	4,17	10	613-4-125
5.5 mm	150 mm	30 mm	97 mm	5,58	10	613-5.5-150
6.5 mm	150 mm	35 mm	110 mm	7,07	10	613-6.5-150

## Destornillador Phillips



### 615

Tip	Length	Shank	Blade	€	Qty	Code
PH 0	75 mm	25 mm	80 mm	3,50	10	615-0-75
PH 1	100 mm	30 mm	97 mm	5,12	10	615-1-100
PH 2	25 mm	35 mm	60 mm	6,48	10	615-2-25
PH 2	125 mm	35 mm	110 mm	6,60	10	615-2-125
PH 3	150 mm	35 mm	110 mm	10,03	10	615-3-150

## Destornillador Pozidriv



### 616

Tip	Length	Shank	Blade	€	Qty	Code
PZ 0	75 mm	25 mm	80 mm	4,55	10	616-0-75
PZ 1	100 mm	30 mm	97 mm	5,51	10	616-1-100
PZ 2	125 mm	35 mm	110 mm	7,09	10	616-2-125
PZ 3	150 mm	35 mm	110 mm	10,63	10	616-3-150

Destornillador TORX®



618



					€		
T 10	75 mm	25 mm	80 mm	<b>5,30</b>	10	618-10-75	
T 15	100 mm	25 mm	80 mm	<b>5,58</b>	10	618-15-100	
T 20	100 mm	25 mm	80 mm	<b>5,58</b>	10	618-20-100	
T 25	125 mm	30 mm	97 mm	<b>6,48</b>	10	618-25-125	
T 27	125 mm	30 mm	97 mm	<b>6,48</b>	10	618-27-125	
T 30	150 mm	35 mm	110 mm	<b>7,97</b>	10	618-30-150	
T 40	150 mm	35 mm	110 mm	<b>9,05</b>	10	618-40-150	

DESTORNILLADORES CON MANGO DE CARRACA

Destornillador de carraca



808050



					€		
1/4"	125 mm	41.6 mm	123 mm	<b>43,08</b>	25	808050	

Juego puntas 1/4" y porta puntas de carraca, 36 piezas



59/S36BCR

		€		
36	43 x 135 x 215 mm	<b>56,17</b>	6	59/S36BCR

Destornillador de carraca con lámpara LED



808050L

			€		
1/4 in	10x35 mm	808050L	<b>41,55</b>	25	808050L
		808050L	<b>10,56</b>	50	808050L-SP1

Destornillador de carraca con mango en forma de pistola



808050P

				€		
1/4 in	135 mm	40 mm	125 mm	<b>41,55</b>	25	808050P



Juego destornillador con carraca de mango giratorio, 25 piezas



**808050P-**

	€		
70 x 158 x 285 mm	131,45	10	808050P-25

Juegos de destornillador a carraca extra corto de 18 piezas



**808050S-18**

	€		
46 x 130 x 195 mm	38,91	30	808050S-18

Destornillador a carraca con mango en T extra corto



**808050TS**

	€		
1/4 in 68 mm 91 mm 63.5 mm	22,07	25	808050TS

Destornillador a carraca extra corto



**808050S**

	€		
1/4 in 68 mm 41 mm 69 mm	22,07	25	808050S

Juegos de destornillador a carraca extra corto de 22 piezas



**808050S-22**

	€		
46 x 130 x 195 mm	38,91	30	808050S-22



# DESTORNILLADORES CON MANGO DE PRECISION

Juego de destornilladores de precisión, 6 piezas



<b>706-1</b>		€				
6		47,03	1	706-1		

700-2-50, 700-2.5-50, 700-1.5-50, 700-3-50		
701-0-50, 701-1-75		

Juego de destornilladores de precisión, 6 piezas



<b>706-2</b>		€				
6		49,03	1	706-2		

700-1.5-50, 700-1.2-50, 700-1-50, 700-1.8-50		
701-00-50, 701-0-50		

Juego de destornilladores de precisión, 6 piezas



<b>706-3</b>		€			
6		49,03	1	706-3	

700-2.5-50, 700-2-50, 700-1.8-50, 700-1.5-50, 700-1.2-50, 700-1-50		
--	--	--

Juego de destornilladores de precisión, 7 piezas



<b>706-4</b>		€					
7		55,24	1	706-4			

700-2.5-50, 700-3.5-75, 700-1.5-50		
701-1-75, 701-0-50		
703-8-50, 703-6-50		



## Juego de destornilladores de precisión, 24 piezas



### 706-5

	€		
24	187,04	1	706-5

700-3-50, 700-2-50, 700-3.5-75, 700-4-75, 700-1.5-50, 700-1.2-50, 700-1-50, 700-1.8-50	
701-00-50, 701-0-50, 701-1-75	
702-1-75, 702-0-50	
703-6-50, 703-9-50, 703-10-50, 703-7-50, 703-8-50, 703-15-75, 703-20-75	
704-2.5-50, 704-3-75, 704-1.5-50, 704-2-50	

## Destornilladores de precisión, ranurados



### 700

				€		
1 mm	50 mm	14 mm	87 mm	7,90	5	700-1-50
1.2 mm	50 mm	14 mm	87 mm	7,90	5	700-1.2-50
1.5 mm	50 mm	14 mm	87 mm	7,90	5	700-1.5-50
1.8 mm	50 mm	14 mm	87 mm	7,90	5	700-1.8-50
2 mm	50 mm	14 mm	87 mm	6,91	5	700-2-50
2.5 mm	50 mm	14 mm	87 mm	6,91	5	700-2.5-50
3 mm	50 mm	14 mm	87 mm	6,61	5	700-3-50
3 mm	100 mm	14 mm	87 mm	6,61	5	700-3-100
3 mm	200 mm	14 mm	87 mm	7,60	5	700-3-200
3.5 mm	75 mm	14 mm	87 mm	6,91	5	700-3.5-75
4 mm	75 mm	14 mm	87 mm	7,16	5	700-4-75
4 mm	250 mm	14 mm	87 mm	8,92	5	700-4-250

## Destornilladores de precisión, Phillips



### 701

				€		
PH 00	50 mm	14 mm	87 mm	8,20	5	701-00-50
PH 0	50 mm	14 mm	87 mm	6,91	5	701-0-50
PH 0	200 mm	14 mm	87 mm	8,69	5	701-0-200
PH 1	75 mm	14 mm	87 mm	7,74	5	701-1-75
PH 1	250 mm	14 mm	87 mm	8,21	5	701-1-250

## Destornilladores de precisión, Pozidriv



### 702

				€		
PZ 0	50 mm	14 mm	87 mm	7,79	5	702-0-50
PZ 1	75 mm	14 mm	87 mm	8,28	5	702-1-75

## Destornilladores de precisión, TORX®



### 703

				€		
T 4	50 mm	14 mm	87 mm	9,46	5	703-4-50
T 5	50 mm	14 mm	87 mm	9,46	5	703-5-50
T 6	50 mm	14 mm	87 mm	7,57	5	703-6-50
T 7	50 mm	14 mm	87 mm	7,57	5	703-7-50
T 8	50 mm	14 mm	87 mm	7,57	5	703-8-50
T 9	50 mm	14 mm	87 mm	7,57	5	703-9-50
T 10	50 mm	14 mm	87 mm	7,57	5	703-10-50
T 15	75 mm	14 mm	87 mm	7,57	5	703-15-75
T 20	75 mm	14 mm	87 mm	7,57	5	703-20-75

Destornilladores de precisión, hexagonal esférica



**704**



					€		
1.5	50 mm	14 mm	87 mm	<b>8,69</b>	5	704-1.5-50	
2	50 mm	14 mm	87 mm	<b>8,69</b>	5	704-2-50	
2.5	50 mm	14 mm	87 mm	<b>8,69</b>	5	704-2.5-50	
3	75 mm	14 mm	87 mm	<b>8,69</b>	5	704-3-75	
3/32	75 mm	14 mm	87 mm	<b>8,68</b>	5	704Z-3/32	

Juego de destornilladores ranurados de precisión, 0,6-2,5 mm (5 piezas)



**98505**



		€		
5		<b>34,26</b>	5	98505*

Destornillador precisión, 4 bocas intercambiables



**510034**



		€		
0.25x1.5, 0.3x2, 0.4x2.5, 0.5x3	8.5 mm	<b>17,89</b>	10	510034

0,25x1,5x25; 0,3x2x25; 0,4x2,5x25; 0,5x3x25

Juego de destornilladores ranurados de precisión, 1,0-3,5 mm (6 piezas)



**510031**



	€		
6	<b>38,14</b>	5	510031

Destornillador para tornillos ranurados



**2784**



			€		
2.5 mm	6 mm	100 mm	<b>36,85</b>	1	2784-2.5
3.5 mm	6 mm	104 mm	<b>36,85</b>	1	2784-3.5
4.5 mm	10 mm	110 mm	<b>36,85</b>	1	2784-4.5

Juego de destornilladores Phillips de precisión, PH000-PH0 (3 piezas)



**510033**

	€		
3	<b>25,14</b>	5	510033

\* Hasta agotar existencias



## DESTORNILLADORES CON MANGO EN T

Juego 6 destornilladores mango en T hexagonales



### 903T-1

	€		
6	78,96	1	903T-1

900T-030-100, 900T-040-150, 900T-050-150, 900T-060-200, 900T-080-200, 900T-100-200		
--	--	--

Juego 6 destornilladores mango en T, TORX®



### 903T-2

	€		
6	72,86	1	903T-2

901T-015-150, 901T-020-150, 901T-010-100, 901T-030-200, 901T-040-200, 901T-025-150		
--	--	--

Juego 6 destornilladores mango en T, Stecker



### 903T-3

	€		
6	90,26	1	903T-3

902T-060-150, 902T-070-175, 902T-050-150, 902T-080-175, 902T-100-175, 902T-130-175		
--	--	--

Destornillador con mango en T hexagonal



### 900T

				€		
2 mm	100 mm	50 mm	85 mm	10,72	5	900T-020-100
2.5 mm	100 mm	50 mm	85 mm	10,72	5	900T-025-100
3 mm	100 mm	50 mm	85 mm	10,72	5	900T-030-100
4 mm	138 mm	50 mm	85 mm	11,98	5	900T-040-150
5 mm	138 mm	60 mm	105 mm	12,45	5	900T-050-150
6 mm	185 mm	60 mm	105 mm	13,24	5	900T-060-200
8 mm	185 mm	60 mm	105 mm	14,51	5	900T-080-200
10 mm	185 mm	60 mm	105 mm	16,08	5	900T-100-200

Destornillador con mango en T TORX®



### 901T

				€		
T 6	100 mm	50 mm	85 mm	7,77	5	901T-006-100
T 7	100 mm	50 mm	85 mm	7,77	5	901T-007-100
T 8	100 mm	50 mm	85 mm	7,77	5	901T-008-100
T 9	100 mm	50 mm	85 mm	7,77	5	901T-009-100
T 10	100 mm	50 mm	85 mm	11,01	5	901T-010-100
T 15	138 mm	50 mm	85 mm	11,21	5	901T-015-150
T 20	138 mm	50 mm	85 mm	11,21	5	901T-020-150
T 25	138 mm	60 mm	105 mm	12,29	5	901T-025-150
T 27	138 mm	60 mm	105 mm	12,29	5	901T-027-150
T 30	185 mm	60 mm	105 mm	13,24	5	901T-030-200

					€		
T 40	185 mm	60 mm	105 mm	105 mm	13,85	5	901T-040-200
T 45	185 mm	60 mm	105 mm	105 mm	13,85	5	901T-045-200
T 50	185 mm	60 mm	105 mm	105 mm	13,85	5	901T-050-200

### Destornillador con mango en T Stecker



#### 902T

					€		
5 mm	136 mm	50 mm	85 mm	85 mm	12,86	5	902T-050-150
5.5 mm	136 mm	50 mm	85 mm	85 mm	12,86	5	902T-055-150
6 mm	136 mm	50 mm	85 mm	85 mm	13,72	5	902T-060-150
7 mm	160 mm	60 mm	105 mm	105 mm	14,51	5	902T-070-175
8 mm	160 mm	60 mm	105 mm	105 mm	14,79	5	902T-080-175
9 mm	160 mm	60 mm	105 mm	105 mm	14,79	5	902T-090-175
10 mm	160 mm	60 mm	105 mm	105 mm	15,76	5	902T-100-175
11 mm	160 mm	60 mm	105 mm	105 mm	15,76	5	902T-110-175
12 mm	160 mm	60 mm	105 mm	105 mm	17,65	5	902T-120-175
13 mm	160 mm	60 mm	105 mm	105 mm	18,60	5	902T-130-175

### Porta vasos mango en T, 1/4"



#### 905T

					€		
1/4"	45 mm	60 mm	105 mm	105 mm	16,56	5	905T-060-100

## DESTORNILLADORES PORTAPUNTAS DE 1/4"

### Destornillador Portapuntas Magnético 1/4" BahcoFit



#### B705

					€		
1/4" in	125 mm	30 mm	105 mm	105 mm	12,36	5	B705.1/4.125
1/4" in	125 mm	30 mm	105 mm	105 mm	13,11	1	SB705.1/4.125

SB: Presentación en clip

### Destornillador porta puntas con mango en T



#### 904T

					€		
1/4 in	150 mm	150 mm	150 mm	150 mm	19,79	5	904T-060-150

### Portapuntas 1/4"



#### 808050A/TORX

					€		
1/4 in	115 mm	40 mm	115 mm	115 mm	27,53	25	808050A
1/4 in	115 mm	40 mm	115 mm	115 mm	26,89	25	808050TORX

## DESTORNILLADORES CON MANGO DE MADERA O PLASTICO

### Destornillador para tornillos ranurados



#### 9710

					€		
3.5 mm	75 mm	22 mm	95 mm	95 mm	5,61	10	9710-3.5-75
5.5 mm	100 mm	24 mm	100 mm	100 mm	7,46	10	9710-5.5-100
6.5 mm	125 mm	27 mm	110 mm	110 mm	8,61	10	9710-6.5-125
8.0 mm	150 mm	30 mm	120 mm	120 mm	9,93	5	9710-8-150
10.0 mm	175 mm	32 mm	125 mm	125 mm	11,90	5	9710-10-175





Destornillador con mango de madera



**9778**

					€		
PH 1		80 mm	24 mm	100 mm	8,09	10	9778-1
PH 2		110 mm	27 mm	110 mm	11,05	10	9778-2
PH 3		150 mm	30 mm	120 mm	14,91	5	9778-3

Destornillador con mango de madera



**9778PZD**

					€		
PZ 1		80 mm	24 mm	100 mm	8,44	10	9778PZD-1
PZ 2		110 mm	27 mm	110 mm	11,49	10	9778PZD-2

Juego de 6 destornilladores con mango de madera



**9710/S6**

		€		
6	X	53,72	1	9710/S6

9710-4.5-90

9710-5.5-100, 9710-6.5-125, 9710-8-150

9778-1, 9778-2

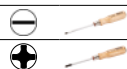

**BAHCO**

Destornillador reversible



**1019/1067**

		€		
4,5 mm		3,59	10	1067
6 mm		4,77	10	1019

Destornillador varilla reversible



**8052**

					€		
PH 2		80 mm	28 mm	110 mm	29,59	5	8052

Destornillador extracorto varilla reversible



**1016**

		€		
6 mm		4,83	10	1016

Para tornillos phillips y planos

Juego de destornillador con 6 varillas reversibles



**6**

		€		
PH 0, PH 1, PH 2	3,5-5,0-6,5 mm	18,14	1	6

Destornillador varilla pasante



**9715**

				€		
14.0 mm	250 mm	32 mm	140 mm	46,01	5	9715-14-250

Destornillador de electrónica para tornillos ranurados



**7372I**

				€		
2.0 mm	63 mm	13 mm	80 mm	13,57	10	7372I-2-63
2.5 mm	75 mm	13 mm	80 mm	13,57	10	7372I-2.5-75
3.0 mm	80 mm	13 mm	80 mm	13,57	10	7372I-3-80

COMPROBADORES ELÉCTRICOS

Destornillador aislado, comprobador de tensión



**806**

				€		
3.0 mm	65 mm	16 mm	75 mm	4,70	6	806-1-1
3.5 mm	100 mm	17.5 mm	90 mm	6,14	6	806-1-2

Comprobador 6-24V

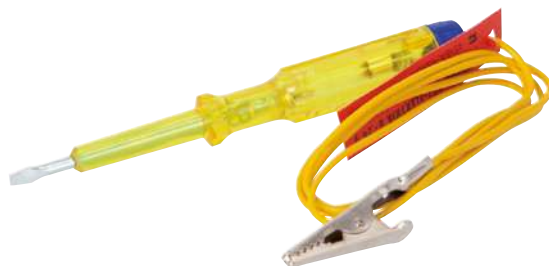

**806-1-3**

				€		
3 mm	45 mm	16 mm	75 mm	6,22	6	806-1-3

Destornillador aislado, comprobador de tensión



**8045VDE**

				€		
3.5 mm	77 mm	14 mm	92 mm	17,63	10	8045VDE



Destornillador aislado, comprobador de tensión



**8045LVDE**



				€		
3.5 mm	42 mm	16 mm	90 mm	21,59	10	8045LVDE

## IMANTADOR DESTORNILLADORES

Imantador - Desimantador



**M780**

	€		
29 x 52 x 50 mm	21,03	1	M780

Magnetizador - Desmagnetizador



**M781**

	€		
22 x 125 x 40 mm	13,30	5	M781



## Llaves Allen



## CON PUNTA HEXAGONAL

Llave hexagonal acodada, niquelada



**1998M**

Hexagon	L	€	Icons
1.5 mm	47 mm	0,62	10 1998M-1.5
2 mm	52 mm	0,64	10 1998M-2
2.5 mm	59 mm	0,68	10 1998M-2.5
3.0 mm	66 mm	0,89	10 1998M-3
4.0 mm	74 mm	0,79	10 1998M-4
5.0 mm	85 mm	1,10	10 1998M-5
6.0 mm	96 mm	1,35	10 1998M-6
7.0 mm	102 mm	1,90	10 1998M-7
8.0 mm	108 mm	2,17	10 1998M-8
9.0 mm	114 mm	2,90	5 1998M-9
10 mm	122 mm	3,03	10 1998M-10
12.0 mm	137 mm	4,45	5 1998M-12
14.0 mm	154 mm	6,02	1 1998M-14
17.0 mm	177 mm	9,52	1 1998M-17
19.0 mm	199 mm	14,28	1 1998M-19
22.0 mm	222 mm	21,17	1 1998M-22

Juego de 6 llaves acodadas, métrica, acabado niquelado



**1998M/**

Hexagon	Quantity	€	Code
2, 2.5, 3, 4, 5, 6 mm	6	7,51	1 1998M/6T

1998M-4, 1998M-5, 1998M-6, 1998M-2.5, 1998M-2, 1998M-3

Juego de 8 llaves hexagonales acodadas niqueladas



**1998M/8T**

Hexagon	Quantity	€	Code
2, 2.5, 3, 4, 5, 6, 7, 8 mm	8	12,07	1 1998M/8T

1998M-3, 1998M-2, 1998M-6, 1998M-7, 1998M-4, 1998M-5, 1998M-8, 1998M-2.5

Juego de 10 llaves acodadas niqueladas



**1998M/10T**

Hexagon	Quantity	€	Code
2, 2.5, 3, 4, 5, 6, 7, 8, 9, 10 mm	10	18,43	1 1998M/10T

Tamaños marcados en el envase para su fácil elección

1998M-5, 1998M-4, 1998M-7, 1998M-6, 1998M-2, 1998M-3, 1998M-2.5, 1998M-8, 1998M-9, 1998M-10

Juego de 11 llaves hexagonales acodadas niqueladas



**1998M/11T**

Hexagon	Quantity	€	Code
2, 2.5, 3, 4, 5, 6, 7, 8, 9, 10, 12 mm	11	23,88	1 1998M/11T

1998M-5, 1998M-4, 1998M-7, 1998M-6, 1998M-2, 1998M-3, 1998M-2.5, 1998M-8, 1998M-9, 1998M-10, 1998M-12

Juego de 15 llaves hexagonales acodadas niqueladas



**1998M/15T**

Hexagon	Quantity	€	Code
2, 2.5, 3, 4, 5, 6, 7, 8, 9, 10, 12, 14, 17, 19, 22 mm	15	78,12	1 1998M/15T

1998M-2, 1998M-5, 1998M-4, 1998M-7, 1998M-6, 1998M-3, 1998M-2.5, 1998M-14, 1998M-17, 1998M-19, 1998M-22, 1998M-8, 1998M-9, 1998M-10, 1998M-12

Juego de 9 llaves hexagonales acodadas niqueladas



**BE-9878**

Hexagon	Quantity	€	Code
1.5, 2, 2.5, 3, 4, 5, 6, 8, 10 mm	9	14,87	1 BE-9878

1998M-1.5, 1998M-2.5, 1998M-2, 1998M-3, 1998M-4, 1998M-5, 1998M-6, 1998M-8, 1998M-10

Juego de 7 llaves hexagonales acodadas



**1999M/7H**

Hexagon	Quantity	€	Code
2.5 3 4 5 6 8 10 mm	7	33,75	1 1999M/7H*

2.5, 3, 4, 5, 6, 8, 10

Juego 12 llaves acodadas hex niqueladas serie larga, pulgadas



**BE-9880**

Hexagon	Quantity	€	Code
0.050; 1/16; 5/64; 3/32; 7/64; 1/8; 9/64; 5/32; 3/16; 7/32; 1/4; 5/16 in	12	39,52	3 BE-9880



Llave tipo allen acodada pavonada, mm



**1995M**

Hex	L	€	Box	Key	Part
0.9 mm	33 mm	0,82	10	1995M-0.9	
1.5 mm	47 mm	0,52	10	1995M-1.5	
2.0 mm	52 mm	0,57	10	1995M-2	
2.5 mm	59 mm	0,59	10	1995M-2.5	
3.0 mm	66 mm	0,78	10	1995M-3	
4.0 mm	74 mm	0,89	10	1995M-4	
5.0 mm	85 mm	0,84	10	1995M-5	
6.0 mm	96 mm	1,06	10	1995M-6	
7.0 mm	102 mm	1,51	10	1995M-7	
8.0 mm	108 mm	1,90	10	1995M-8	
9.0 mm	114 mm	2,18	10	1995M-9	
10 mm	122 mm	2,44	10	1995M-10	
12 mm	137 mm	3,94	10	1995M-12	
14 mm	154 mm	5,56	10	1995M-14	
17 mm	177 mm	8,92	10	1995M-17	
19 mm	199 mm	13,44	10	1995M-19	
22 mm	222 mm	20,03	10	1995M-22	

Juego de 6 llaves hexagonales acodadas pavonadas



**1995M/**

Hex	Box	€	Key	Part
2, 2.5, 3, 4.5, 6 mm	6	5,76	1	1995M/6T

1995M-2, 1995M-2.5, 1995M-3, 1995M-4, 1995M-5, 1995M-6

Juego de 11 llaves acodadas pavonadas hexagonales, mm



**1995M/11T**

Hex	Box	€	Key	Part
2, 2.5, 3, 4, 5, 6, 7, 8, 9, 10, 12 mm	11	21,17	1	1995M/11T

1995M-2, 1995M-6, 1995M-5, 1995M-4, 1995M-2.5, 1995M-3, 1995M-9, 1995M-10, 1995M-7, 1995M-8, 1995M-12

Juego de 8 llaves hexagonales acodadas pavonadas



**1995M/8T**

Hex	Box	€	Key	Part
2, 2.5, 3, 4, 5, 6, 7, 8 mm	8	10,65	1	1995M/8T

1995M-2, 1995M-2.5, 1995M-3, 1995M-4, 1995M-5, 1995M-6, 1995M-7, 1995M-8

Juego de 15 llaves acodadas pavonadas hexagonales, mm



**1995M/15T**

Hex	Box	€	Key	Part
2, 2.5, 3, 4, 5, 6, 7, 8, 9, 10, 12, 14, 17, 19, 22 mm	15	72,53	1	1995M/15T

1995M-2, 1995M-2.5, 1995M-3, 1995M-4, 1995M-5, 1995M-6, 1995M-7, 1995M-8, 1995M-9, 1995M-10, 1995M-12, 1995M-14, 1995M-17, 1995M-19, 1995M-22

Llave acodada, pulgadas, pavonada



**1995Z**

Hex	L	€	Box	Key	Part
1/16 in	47 mm	0,56	10	1995Z-1/16	
5/64 in	52 mm	0,45	10	1995Z-5/64	
3/32 in	59 mm	0,48	10	1995Z-3/32	
1/8 in	66 mm	0,62	10	1995Z-1/8	
5/32 in	74 mm	0,76	10	1995Z-5/32	
3/16 in	85 mm	0,87	10	1995Z-3/16	
7/32 in	91 mm	1,00	10	1995Z-7/32	
1/4 in	96 mm	1,23	10	1995Z-1/4	
5/16 in	108 mm	2,06	10	1995Z-5/16	
3/8 in	122 mm	2,98	10	1995Z-3/8	
7/16 in	129 mm	4,56	10	1995Z-7/16	
1/2 in	145 mm	5,58	10	1995Z-1/2	
5/8 in	168 mm	10,08	10	1995Z-5/8	
3/4 in	199 mm	17,02	10	1995Z-3/4	

Juego de 10 llaves acodadas pavonadas hexagonal, mm



**1995M/10T**

Hex	Box	€	Key	Part
2, 2.5, 3, 4, 5, 6, 7, 8, 9, 10 mm	10	17,21	1	1995M/10T

1995M-2.5, 1995M-2, 1995M-6, 1995M-5, 1995M-4, 1995M-3, 1995M-9, 1995M-10, 1995M-7, 1995M-8

Juego de 9 llaves hexagonales acodadas pavonadas



**BE-9578**

Hex	Box	€	Key	Part
1.5, 2, 2.5, 3, 4, 5, 6, 8, 10 mm	9	13,43	1	BE-9578

1995M-2.5, 1995M-2, 1995M-1.5, 1995M-6, 1995M-5, 1995M-4, 1995M-3, 1995M-8, 1995M-10

\* Hasta agotar existencias



Juego de 7 llaves hexagonales acodadas



**BE-9777B**

		€		
2.5 3 4 5 6 8 10 mm	7	24,19	6	BE-9777B

2.5, 3, 4, 5, 6, 8, 10 mm

Juego de 10 llaves acodadas hex pavonadas, pulgadas



**1995Z/**

		€		
1/16, 5/64, 3/32, 1/8, 5/32, 3/16, 7/32, 1/4, 5/16, 3/8 in	10	14,20	1	1995Z/10T

1995Z-1/16, 1995Z-5/64, 1995Z-3/32, 1995Z-1/8, 1995Z-5/32, 1995Z-3/16, 1995Z-3/8, 1995Z-7/32, 1995Z-1/4, 1995Z-5/16

Llave acodada pavonada serie larga, mm



**1995LM**

		€		
1.5 mm	91 mm	0,72	10	1995LM-1.5
2 mm	102 mm	0,53	10	1995LM-2
2.5 mm	114 mm	0,63	10	1995LM-2,5
3.0 mm	129 mm	0,82	10	1995LM-3
4.0 mm	144 mm	0,95	10	1995LM-4
5.0 mm	165 mm	1,39	10	1995LM-5
6.0 mm	186 mm	2,08	10	1995LM-6
7.0 mm	197 mm	2,74	10	1995LM-7
8.0 mm	208 mm	3,56	10	1995LM-8
9.0 mm	219 mm	4,45	10	1995LM-9
10 mm	234 mm	5,01	10	1995LM-10
12 mm	262 mm	7,51	10	1995LM-12
14 mm	294 mm	9,27	10	1995LM-14

Juego de 7 llaves hexagonales



**BE-9776**

		€		
1.5 2.2 2.5 3 4 5 6 mm	6	18,60	6	BE-9776

1.5, 2, 2.5, 3, 4, 5, 6 mm

Juego de 12 llaves acodadas pavonadas, pulgadas



**1995Z/12T**

		€		
1/16, 5/64, 3/32, 1/8, 5/32, 3/16, 7/32, 1/4, 5/16, 3/8, 7/16, 1/2 in	12	23,12	1	1995Z/12T

1995Z-1/16, 1995Z-5/64, 1995Z-3/32, 1995Z-1/8, 1995Z-5/32, 1995Z-3/16, 1995Z-1/2, 1995Z-7/16, 1995Z-3/8, 1995Z-7/32, 1995Z-1/4, 1995Z-5/16

Juego de 6 llaves hexagonales acodadas pavonadas



**BE-9586**

		€		
1.5, 2, 2.5, 3, 4, 5 mm	6	10,36	1	BE-9586

1995LM-1.5, 1995LM-3, 1995LM-2.5, 1995LM-2, 1995LM-4, 1995LM-5

Juego de 7 llaves hexagonales en navaja



**BE-9777**

		€		
2.5 3 4 5 6 8 10 mm	7	25,22	6	BE-9777

2.5, 3, 4, 5, 6, 8, 10 mm

Juego de 7 llaves hexagonales



**BE-9787**

		€		
3/32 1/8 5/32 3/16 1/4 5/16 3/8 in	7	26,69	6	BE-9787

Juego de 9 llaves acodadas serie larga



**BE-9588**

		€		
1.5, 2, 2.5, 3, 4, 5, 6, 8, 10 mm	9	21,29	1	BE-9588

1995LM-1.5, 1995LM-2, 1995LM-2.5, 1995LM-3, 1995LM-4, 1995LM-5, 1995LM-6, 1995LM-8, 1995LM-10

Llave tipo allen acodada, con bola, pavonada



**1996M**

Hex Size	Length	Price (€)	Qty	Part No.
1.5 mm	91 mm	1,67	10	1996M-1.5
2.0 mm	102 mm	1,85	10	1996M-2
2.5 mm	114 mm	1,68	10	1996M-2.5
3.0 mm	129 mm	1,73	10	1996M-3
4.0 mm	144 mm	2,06	10	1996M-4
5.0 mm	165 mm	3,37	10	1996M-5
6.0 mm	186 mm	3,83	10	1996M-6
8.0 mm	208 mm	5,40	10	1996M-8
10 mm	234 mm	9,67	10	1996M-10
12 mm	262 mm	10,34	5	1996M-12

Juego de 9 llaves tipo allen hexagonales de colores con bola



**C1997LM/9P**

Hex Size	Length	Price (€)	Qty	Part No.
1.5, 2, 2.5, 3, 4, 5, 6, 8, 10 mm	9	37,87	1	C1997LM/9P

Juego de 6 llaves hexagonales acodadas con bola pavonadas



**BE-9765**

Hex Size	Length	Price (€)	Qty	Part No.
1.5, 2, 2.5, 3, 4, 5 mm	6	11,07	3	BE-9765

1996M-1.5, 1996M-2.5, 1996M-2, 1996M-4, 1996M-3, 1996M-5

Juego de 9 llaves acodadas pavonadas hex bola, mm



**BE-9770**

Hex Size	Length	Price (€)	Qty	Part No.
1.5, 2, 2.5, 3, 4, 5, 6, 8, 10 mm	9	18,25	3	BE-9770

Juego de 6 llaves hexagonales acodadas con bola pavonadas



**BE-9676**

Hex Size	Length	Price (€)	Qty	Part No.
1.5, 2, 2.5, 3, 4, 5 mm	6	17,95	1	BE-9676

1996M-1.5, 1996M-2, 1996M-2.5, 1996M-3, 1996M-4, 1996M-5

Juego de 9 llaves acodadas pavonadas Hex Bola serie larga



**BE-9678**

Hex Size	Length	Price (€)	Qty	Part No.
1.5, 2, 2.5, 3, 4, 5, 6, 8, 10 mm	9	33,25	1	BE-9678

1996M-4, 1996M-5, 1996M-2.5, 1996M-3, 1996M-10, 1996M-6, 1996M-8, 1996M-2, 1996M-1.5

Juego de llaves hexagonales acodadas con bola



**BE-9688**

Hex Size	Length	Price (€)	Qty	Part No.
1.5, 2, 2.5, 3, 4, 5, 6, 8, 10 mm	9	35,50	1	BE-9688

1996M-1.5, 1996M-2, 1996M-2.5, 1996M-3, 1996M-4, 1996M-5, 1996M-6, 1996M-8, 1996M-10

Juego de 7 llaves tipo allen con bola en navaja



**BE-9776B**

Hex Size	Length	Price (€)	Qty	Part No.
2.5, 3, 4, 5, 6, 8, 10 mm	7	35,97	6	BE-9776B

Juego de 7 llaves hexagonales



**BE-9775**

Hex Size	Length	Price (€)	Qty	Part No.
1/16, 5/64, 3/32, 1/8, 5/32, 3/16, 1/4 in	7	16,37	3	BE-9775

5/64 3/32 1/4 1/8 1/16 5/32 3/16





Juego de 12 llaves acodadas hex bola serie larga, pulgadas



**BE-9780**



0.05 1/16 5/64 3/32 7/64 1/8 9/64 5/32 3/16 7/32 1/4 5/16 in 12 30,17 3 BE-9780

0.05 1/16 5/64 3/32 7/64 1/8 9/64 5/32 3/16 7/32 1/4 5/16

Juego de 13 llaves acodadas hex bola serie larga, pulgadas



**BE-9785**



0.05 1/16 5/64 3/32 7/64 1/8 9/64 5/32 3/16 7/32 1/4 5/16 3/8 in 13 27,94 3 BE-9785

0.05 1/16 5/64 3/32 7/64 1/8 9/64 5/32 3/16 7/32 1/4 5/16 3/8

**CON PUNTA TORX®**

Llave tipo allen TORX® pavonada



**1995TORX**



	L	€		
T6	75 mm	6,45	5	1995TORX-T6
T7	80 mm	6,45	5	1995TORX-T7
T8	80 mm	6,45	5	1995TORX-T8
T9	80 mm	6,11	5	1995TORX-T9
T10	86 mm	5,22	5	1995TORX-T10
T15	90 mm	5,33	5	1995TORX-T15
T20	95 mm	5,54	5	1995TORX-T20
T25	100 mm	5,56	5	1995TORX-T25
T27	105 mm	5,69	5	1995TORX-T27
T30	114 mm	5,78	5	1995TORX-T30
T40	124 mm	6,06	5	1995TORX-T40
T45	133 mm	6,31	5	1995TORX-T45
T50	152 mm	7,17	5	1995TORX-T50
T55	184 mm	10,19	5	1995TORX-T55
T60	204 mm	12,36	5	1995TORX-T60

Juego 9 llaves tipo allen TORX® de colores



**C1997TORX/9P**



8, 9, 10, 15, 20, 25, 27, 30, 40 9 37,87 1 C1997TORX/9P

Juego 4 llaves acodadas TORX®



**1995TORX/**



10, 20, 30, 40 4 25,38 1 1995TORX/4T

1995TORX-T40, 1995TORX-T30, 1995TORX-T10, 1995TORX-T20

Juego de 7 llaves acodadas pavonadas TORX®



**1995TORX/7T**



10, 15, 20, 25, 27, 30, 40 7 41,39 1 1995TORX/7T

1995TORX-T20, 1995TORX-T10, 1995TORX-T15, 1995TORX-T27, 1995TORX-T25, 1995TORX-T30, 1995TORX-T40

Juego de 11 llaves acodadas pavonadas TORX®



**1995TORX/11T**



7, 9, 10, 15, 20, 25, 27, 30, 40, 45, 50 11 69,34 1 1995TORX/11T

1995TORX-T7, 1995TORX-T9, 1995TORX-T10, 1995TORX-T15, 1995TORX-T20, 1995TORX-T25, 1995TORX-T27, 1995TORX-T30, 1995TORX-T40, 1995TORX-T45, 1995TORX-T50

Juego de 13 llaves acodadas pavonadas TORX®, mm



**1995TORX/13T**



6, 7, 8, 9, 10, 15, 20, 25, 27, 30, 40, 45, 50 13 83,25 1 1995TORX/13T

1995TORX-T6, 1995TORX-T7, 1995TORX-T8, 1995TORX-T9, 1995TORX-T10, 1995TORX-T15, 1995TORX-T20, 1995TORX-T25, 1995TORX-T27, 1995TORX-T30, 1995TORX-T40, 1995TORX-T45, 1995TORX-T50

Juego de 8 llaves acodadas TORX® pavonadas



**BE-9575**



T9, T10, T15, T20, T25, T27, T30, T40 8 47,44 1 BE-9575

1995TORX-T40, 1995TORX-T30, 1995TORX-T27, 1995TORX-T25, 1995TORX-T20, 1995TORX-T15, 1995TORX-T10, 1995TORX-T9

Juego de 8 llaves acodadas TORX® pavonadas



**BE-9585**

Icon	X	€	Icon	Icon
★	X	€	Icon	Icon
T9, T10, T15, T20, T25, T27, T30, T40	8	50,32	1	BE-9585

1995TORX-T9, 1995TORX-T10, 1995TORX-T15, 1995TORX-T20, 1995TORX-T25, 1995TORX-T27, 1995TORX-T30, 1995TORX-T40

Juego de 8 llaves acodadas pavonadas TORX®



**BE-8975B**

Icon	X	€	Icon	Icon
★	X	€	Icon	Icon
T9 - T10 - T15 - T20 - T25 - T27 - T30 - T40	8	43,06	6	BE-8975B

Juego de 8 llaves para tornillos TORX®



**BE-8975**

Icon	X	€	Icon	Icon
★	X	€	Icon	Icon
T 9 10 15 20 25 27 30 40	8	43,06	6	BE-8975

Llave acodada TORX® con bola, pavonada



**1996TORX**

Icon	L	€	Icon	Icon
★	L	€	Icon	Icon
T9	80 mm	7,93	5	1996TORX-T9
T10	86 mm	9,15	5	1996TORX-T10
T15	90 mm	9,45	5	1996TORX-T15
T20	95 mm	9,59	5	1996TORX-T20
T25	100 mm	9,74	5	1996TORX-T25
T27	105 mm	9,81	5	1996TORX-T27
T30	114 mm	10,27	5	1996TORX-T30
T40	124 mm	10,95	5	1996TORX-T40
T45	133 mm	11,47	5	1996TORX-T45
T50	152 mm	13,00	5	1996TORX-T50

Llave acodada TORX® inviolable, pavonada



**1986TORX**

Icon	L	€	Icon	Icon
★	L	€	Icon	Icon
TR 9	80 mm	8,69	5	1986TORX-T9
TR 10	86 mm	9,00	5	1986TORX-T10
TR 15	90 mm	9,23	5	1986TORX-T15
TR 20	95 mm	9,35	5	1986TORX-T20
TR 25	100 mm	9,52	5	1986TORX-T25
TR 27	105 mm	9,59	5	1986TORX-T27
TR 30	114 mm	9,98	5	1986TORX-T30
TR 40	124 mm	10,65	5	1986TORX-T40

Juego 5 llaves acodadas TORX® con bola



**1996TORX/**

Icon	X	€	Icon	Icon
★	X	€	Icon	Icon
T10, T20, T25, T30, T40	5	48,30	1	1996TORX/5T

1996TORX-T10, 1996TORX-T20, 1996TORX-T25, 1996TORX-T30, 1996TORX-T40

Juego 7 llaves acodadas TORX® inviolable



**1986TORX/**

Icon	X	€	Icon	Icon
★	X	€	Icon	Icon
TR10, TR15, TR20, TR25, TR27, TR30, TR40	7	70,86	1	1986TORX/7T

1986TORX-T10, 1986TORX-T15, 1986TORX-T20, 1986TORX-T25, 1986TORX-T27, 1986TORX-T30, 1986TORX-T40

Juego de 8 llaves Torx® acodadas con bola, pavonadas



**BE-9675**

Icon	X	€	Icon	Icon
★	X	€	Icon	Icon
T9, T10, T15, T20, T25, T27, T30, T40	8	69,03	1	BE-9675

1996TORX-T9, 1996TORX-T10, 1996TORX-T15, 1996TORX-T20, 1996TORX-T25, 1996TORX-T27, 1996TORX-T30, 1996TORX-T40

Juego de 8 llaves acodadas TORX® inviolables



**BE-8675**

Icon	X	€	Icon	Icon
★	X	€	Icon	Icon
T9, T10, T15, T20, T25, T27, T30, T40	8	77,34	1	BE-8675

1986TORX-T9, 1986TORX-T10, 1986TORX-T15, 1986TORX-T20, 1986TORX-T25, 1986TORX-T27, 1986TORX-T30, 1986TORX-T40





Juego de 8 llaves TORX® acodadas



**BE-8976B**



T9, T10, T15, T20, T25, T27, T30, T40 8 48,91 6 BE-8976B

Llave acodada TORX PLUS®, pavonada



**1976TORX**

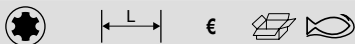

	L	€		
IP 6	75 mm	7,85	5	1976TORX-T6
IP 7	80 mm	7,85	5	1976TORX-T7
IP 8	80 mm	7,85	5	1976TORX-T8
IP 9	80 mm	7,61	5	1976TORX-T9
IP 10	86 mm	7,94	5	1976TORX-T10
IP 15	90 mm	8,17	5	1976TORX-T15
IP 20	95 mm	8,26	5	1976TORX-T20
IP 25	100 mm	8,37	5	1976TORX-T25
IP 27	105 mm	9,28	5	1976TORX-T27
IP 30	114 mm	9,73	5	1976TORX-T30
IP 40	124 mm	10,39	5	1976TORX-T40

Juego 5 llaves acodadas TORX PLUS® pavonadas



**1976TORX/**



IP 10, IP 20, IP 25, IP 30, IP 40 5 42,46 1 1976TORX/5T

1976TORX-T10, 1976TORX-T20, 1976TORX-T25, 1976TORX-T40, 1976TORX-T30

Juego de 8 llaves TORX PLUS® acodada pavonada



**BE-7675**



IP9, IP10, IP15, IP20, IP25, IP27, IP30, IP40 8 64,28 1 BE-7675

1976TORX-T9, 1976TORX-T10, 1976TORX-T15, 1976TORX-T20, 1976TORX-T25, 1976TORX-T27, 1976TORX-T30, 1976TORX-T40

## LLAVES ALLEN DE DOS BOCAS

Destornillador acodado boca recta



**2047**



	L	€		
4.0 mm	100 mm	6,56	5	2047-0.8-4
5.5 mm	125 mm	8,00	5	2047-1-5.5
8.0 mm	150 mm	10,25	5	2047-1.2-8
10.0 mm	175 mm	14,07	1	2047-1.6-10
12.0 mm	200 mm	20,51	1	2047-2-12

Destornillador acodado boca Phillips



**2047PR**



	L	€		
PH 1 & 2	100 mm	8,24	5	2047PR-1-2
PH 3 & 4	200 mm	13,62	5	2047PR-3-4

Destornillador acodado doble boca para tornillos Pozidriv



**2047PZ**



PZ1, PZ2 100 mm 8,44 5 2047PZ-1-2

## MULTIHERRAMIENTAS

Juego de herramientas para bicicleta



**BKE850901N**

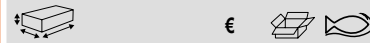

200 x 35 x 170 mm 15,44 10 BKE850901N



# Alicates



## ALICATES DE CORTE

Alicate de corte diagonal con filos progresivos



ergo®



### 2101G

Cu	Fe*	Plasto	L	€		
3.5 mm	1.8 mm	1.6 mm	125 mm	24,72	5	2101G-125
3.7 mm	2.0 mm	1.8 mm	140 mm	25,15	5	2101G-140
3.8 mm	2.5 mm	2.0 mm	160 mm	25,67	5	2101G-160
4.0 mm	2.7 mm	2.3 mm	180 mm	27,46	5	2101G-180
3.5 mm	1.8 mm	1.6 mm	125 mm	23,09	5	2101G-125IP
3.7 mm	2.0 mm	1.8 mm	140 mm	23,51	5	2101G-140IP
3.8 mm	2.5 mm	2.0 mm	160 mm	24,07	5	2101G-160IP
4.0 mm	2.7 mm	2.3 mm	180 mm	25,79	5	2101G-180IP

IP: Embalaje industrial

Alicate de corte diagonal con filos progresivos



ergo®



### 2101G D

Cu	Fe*	Plasto	L	€		
3.5 mm	1.8 mm	1.6 mm	125 mm	23,09	5	2101G-125IPD
3.7 mm	2.0 mm	1.8 mm	140 mm	23,51	5	2101G-140IPD
3.8 mm	2.5 mm	2.0 mm	160 mm	24,07	5	2101G-160IPD
4.0 mm	2.7 mm	2.3 mm	180 mm	25,79	5	2101G-180IPD

Alicate de corte diagonal para plástico



ergo®



### 2101PG

L	€		
160 mm	55,61	5	2101PG-160

BAHCO®

Alicate de corte lateral cromado plateado con filos progresivos



ergo®



### 2101GC

Cu	Fe*	Plasto	L	€		
3.5 mm	1.8 mm	1.6 mm	125 mm	23,46	5	2101GC-125IP
3.7 mm	2.0 mm	1.8 mm	140 mm	23,59	5	2101GC-140IP
3.8 mm	2.5 mm	2.0 mm	160 mm	24,57	5	2101GC-160IP
4.0 mm	2.7 mm	2.3 mm	180 mm	26,77	5	2101GC-180IP

IP: Embalaje industrial

Alicates de corte diagonal con filo progresivo



### 2101D

Cu	Fe*	Plasto	L	€		
3.5 mm	1.8 mm	1.6 mm	125 mm	20,67	5	2101D-125
3.7 mm	2.0 mm	1.8 mm	140 mm	20,67	5	2101D-140
3.8 mm	2.5 mm	2.0 mm	160 mm	21,02	5	2101D-160
4.0 mm	2.7 mm	2.3 mm	180 mm	22,87	5	2101D-180
3.5 mm	1.8 mm	1.6 mm	125 mm	19,03	5	2101D-125IP
3.7 mm	2.0 mm	1.8 mm	140 mm	19,03	5	2101D-140IP
3.8 mm	2.5 mm	2.0 mm	160 mm	19,36	5	2101D-160IP
4.0 mm	2.7 mm	2.3 mm	180 mm	21,22	5	2101D-180IP

IP: Embalaje industrial

Alicate cortante "Heavy Duty"



ergo®



### 21HDG

Fe*	Plasto	L	€		
2.3 mm	2.1 mm	140 mm	27,80	5	21HDG-140
2.7 mm	2.3 mm	160 mm	28,53	5	21HDG-160
3.3 mm	2.8 mm	180 mm	31,27	5	21HDG-180
3.3 mm	2.8 mm	200 mm	33,26	5	21HDG-200
2.3 mm	2.1 mm	140 mm	26,16	5	21HDG-140IP
2.7 mm	2.3 mm	160 mm	26,89	5	21HDG-160IP
3.3 mm	2.8 mm	180 mm	29,63	5	21HDG-180IP
3.3 mm	2.8 mm	200 mm	31,63	5	21HDG-200IP

IP: Embalaje industrial

Alicate corte diagonal angulado 14° para aplicaciones "Heavy Duty"



ergo®



**21HDG-A**

Fez	Plano	L	€		
2.2 mm	2.0 mm	140 mm	<b>29,49</b>	5	21HDG-140A
2.5 mm	2.3 mm	160 mm	<b>30,65</b>	5	21HDG-160A
2.7 mm	2.5 mm	180 mm	<b>33,59</b>	5	21HDG-180A
3.2 mm	3.0 mm	200 mm	<b>35,81</b>	5	21HDG-200A

Alicate corte diagonal "Heavy Duty" cromado



ergo®



**21HDGC**

Fez	Plano	L	€		
2.2 mm	2.2 mm	140 mm	<b>27,38</b>	5	21HDGC-140IP
2.5 mm	2.5 mm	160 mm	<b>28,49</b>	5	21HDGC-160IP
2.8 mm	2.8 mm	180 mm	<b>30,94</b>	5	21HDGC-180IP
3.2 mm	3.0 mm	200 mm	<b>32,54</b>	5	21HDGC-200IP

IP: Embalaje industrial

Alicate corte diagonal extra fuerte "Heavy Duty"



**21HDD**

Fez	Plano	L	€		
2.2 mm	2.2 mm	140 mm	<b>23,62</b>	5	21HDD-140
2.5 mm	2.5 mm	160 mm	<b>24,24</b>	5	21HDD-160
2.8 mm	2.8 mm	180 mm	<b>26,50</b>	5	21HDD-180
3.2 mm	3.0 mm	200 mm	<b>29,02</b>	5	21HDD-200
2.2 mm	2.2 mm	140 mm	<b>21,98</b>	5	21HDD-140IP
2.5 mm	2.5 mm	160 mm	<b>22,63</b>	5	21HDD-160IP
2.8 mm	2.8 mm	180 mm	<b>24,85</b>	5	21HDD-180IP
3.2 mm	3.0 mm	200 mm	<b>27,37</b>	5	21HDD-200IP

Mini cortavarillas, filos céntricos de precisión, extra fuerte



**1520G**

Plano	L	€		
3.8 mm	210 mm	<b>40,04</b>	5	1520 G
3.8 mm	210 mm	<b>39,93</b>	5	1520 G IP

IP embalaje industrial

Alicate corte diagonal, filos céntricos de precisión



**1520D**

Plano	L	€		
3.8 mm	205 mm	<b>45,16</b>	5	1520 D

Alicate de corte diagonal



ergo®



**4130, 4131**

Plano	L	€		
0.3-1.5 mm	120 mm	<b>49,31</b>	3	4130
0.3-1.5 mm	120 mm	<b>49,31</b>	3	4131



Alicate corte diagonal, cabeza rebajada



**C3330R/C3340R**

		€		
0,3-1,25 mm	115 mm	<b>35,93</b>	10	C3330R IP
0,4-1,6 mm	130 mm	<b>37,33</b>	10	C3340R IP

Alicate de corte diagonal cromado



**2666NB-2676NB**

			€		
2.7 mm	2.0 mm	160 mm	<b>84,86</b>	1	2674 NB

Alicate de corte diagonal para plástico



**2100PD**

			€		
1.8 mm	3.0 mm	150 mm	<b>32,30</b>	5	2100PD-150

Máx capacidad Cu1.8mm y plástico PA (Bylon) 3mm

Alicate de corte diagonal cromado



**2667B-2678B**

				€		
3.7 mm	2.0 mm	2.0 mm	160 mm	<b>87,80</b>	1	2676 B
4.0 mm	2.5 mm	2.5 mm	200 mm	<b>98,08</b>	1	2678 B

Alicate de corte lateral



**2171G**

				€		
2.5 mm	1.6 mm	1.5 mm	150 mm	<b>19,44</b>	5	2171G-140
2.5 mm	1.6 mm	1.5 mm	160 mm	<b>20,05</b>	5	2171G-160
2.5 mm	1.6 mm	1.5 mm	185 mm	<b>22,13</b>	5	2171G-180

Alicate de corte diagonal de precisión



**2646M - 2649**

			€		
0.1-0.8 mm	Flush	108 mm	<b>93,35</b>	1	2646 M
0.2-1.25 mm	Micro-bevel	110 mm	<b>79,12</b>	1	2646 R
0.2-1.25 mm	Micro-bevel	110 mm	<b>119,63</b>	1	2646 RK
0.1-1.0 mm	Flush	110 mm	<b>93,49</b>	1	2646 RA
0.3-1.6 mm	Micro-bevel	112,5 mm	<b>84,23</b>	1	2666
0.4-2.0 mm	Micro-bevel	125 mm	<b>90,23</b>	1	2649



Alicate de corte diagonal de precisión



**2646 - 2648A**

			€		
0.2-1.25 mm	Micro-bevel	110 mm	<b>84,23</b>	1	2646
0.2-1.25 mm	Micro-bevel	110 mm	<b>95,39</b>	1	2646 K
0.1-1.0 mm	Ultra-flush	110 mm	<b>95,86</b>	1	2646 A
0.1-1.0 mm	Ultra-flush	110 mm	<b>91,99</b>	1	2646 AK
0.2-1.25 mm	Ultra-flush	112.5 mm	<b>98,88</b>	1	2666 FK
0.4-2.0 mm	Micro-bevel	125 mm	<b>79,60</b>	1	2648
0.3-1.6 mm	Ultra-flush	125 mm	<b>113,64</b>	1	2648 A

Alicate de corte oblicuo



ergo®



**4231**

		€		
0.3-1.25 mm	119 mm	<b>67,78</b>	3	4231

Alicate de corte oblicuo 45°



ergo®



**4239**

		€		
0.3-1.0 mm	129 mm	<b>66,48</b>	3	4239

Alicate de corte oblicuo para plástico



**2145PD**

			€		
3.0 mm	1.8 mm	154 mm	<b>52,06</b>	5	2145PD-150

Alicate de corte oblicuo 45°



**2787F**

			€		
0.2-1.0 mm	Flush	117.5 mm	<b>123,97</b>	1	2787 F

Alicate de corte oblicuo 45°



**2787G**

			€		
0.2-0.8 mm	Flush	117.5 mm	<b>135,36</b>	1	2787 G





\* Hasta agotar existencias



Alicate cortante frontal para cuerda de piano







**527 GC**

		€		
2.0 mm	160 mm	<b>33,92</b>	3	527 GC-160
2.5 mm	200 mm	<b>40,50</b>	3	527 GC-200

Tenaza de encofrador, modelo ruso



**2339**





		€		
2.2 mm	220 mm	<b>16,57</b>	3	2339-220
2.2 mm	220 mm	<b>15,97</b>	5	2339-220IP
2.5 mm	250 mm	<b>17,95</b>	5	2339-250IP
3.0 mm	280 mm	<b>20,42</b>	5	2339-280IP
4.5 mm	300 mm	<b>27,30</b>	6	2339-300IP

IP: Embalaje industrial

Alicates de corte frontal pavonados







**527D**

		€		
2 mm	160 mm	<b>27,21</b>	5	527 D-160
2.5 mm	200 mm	<b>32,51</b>	5	527 D-200

Tenaza de carpintero, alambre de hierro







**541D**

		€		
2.0 mm	150 mm	<b>17,12</b>	5	541 D-150
2.0 mm	180 mm	<b>18,34</b>	5	541D-180
2.5 mm	200 mm	<b>19,46</b>	5	541 D-200
2.5 mm	225 mm	<b>22,42</b>	5	541D-225
2.5 mm	250 mm	<b>25,51</b>	5	541 D-250

Tenaza rusa, alambre de hierro



**2339D**





		€		
2.2 mm	220 mm	<b>20,79</b>	3	2339 D
2.2 mm	220 mm	<b>20,10</b>	5	2339 DIP
4.5 mm	300 mm	<b>25,17</b>	5	2339D-300
4.5 mm	300 mm	<b>24,57</b>	6	2339D-300IP

IP: Embalaje industrial

Alicates de corte frontal pavonados



**1519D**

		€		
2.5 mm	230 mm	<b>125,63</b>	3	1519 D
		<b>62,61</b>	1	1519-9

Alicate de corte frontal



**C3230**

	€		
109 mm	50,16	10	C3230IP

Alicates de corte oblicuo para plástico



**2190PD**

			€		
1.8 mm	3.0 mm	143 mm	55,03	5	2190PD-150

Alicate de corte frontal



**2656/2656A**

			€		
0.35 - 0.8 mm	Micro	115 mm	87,53	1	2656

Cortacables y pelacables



**2233D**

			€		
10 mm	50/35 mm	160 mm	34,36	5	2233 D-160
13 mm	70/50 mm	200 mm	42,21	5	2233 D-200
16 mm	95/70 mm	240 mm	47,62	5	2233 D-240
10 mm	50/35 mm	160 mm	33,66	5	2233D-160IP
13 mm	70/50 mm	200 mm	41,50	5	2233D-200IP
16 mm	95/70 mm	240 mm	46,92	5	2233D-240IP

IP: Embalaje industrial

Cortacables



**2520**

	€		
550 mm	180,74	1	2520

2520-SH: hojas de repuesto, tornillos y tuerca

Cortacables para cobre



**2620-80**

		€		
42 mm	800 mm	292,17	1	2620-80

\* Hasta agotar existencias



Cortacables de acero



**2720**

Icono	L	€	Icono	Icono
	600 mm	<b>250,35</b>		1 2720
	163 mm	<b>191,44</b>		1 2720-SH

2720-SH: Hoja de repuesto para 2720

Cortacables de acero



**2235-160**

L	€	Icono	Icono
165 mm	<b>51,97</b>		1 2235-160

Cortacables con carraca



**2804-2805**

Icono	Icono	L	€	Icono	Icono
		250 mm	<b>449,35</b>		1 2804
		280 mm	<b>525,52</b>		1 2805-280

Cortacables



**2800N-2801N**

Icono	L	€	Icono	Icono
	170 mm	<b>72,08</b>		1 2800 N
0-10 mm	230 mm	<b>88,82</b>		1 2801 N

Cortavarillas



**4559**

Icono	Icono	Icono	L	€	Icono	Icono
			330 mm	<b>89,96</b>		1 4559-12
			430 mm	<b>111,86</b>		8 4559-18
			600 mm	<b>133,27</b>		6 4559-24
			750 mm	<b>160,25</b>		5 4559-30
			900 mm	<b>210,34</b>		3 4559-36
			1060 mm	<b>294,73</b>		2 4559-42

Cabeza de corte de recambio para cortavarillas 4559



**4559 JC**

g	€	Icono	Icono
285 g	<b>55,38</b>		1 4559-12A JC
600 g	<b>71,60</b>		1 4559-18B JC
930 g	<b>85,29</b>		1 4559-24B JC
1260 g	<b>102,56</b>		1 4559-30B JC
2180 g	<b>134,62</b>		1 4559-36B JC
3025 g	<b>130,28</b>		1 4559-42A JC

Cortavarillas de corte diagonal, mm



**4560-210**

	€		
250 mm	57,40	1	4560-210

**ALICATES UNIVERSALES**

Alicates universales



**2628G**

			€		
1.8 mm	2.0 mm	160 mm	25,50	5	2628 G-160
2.0 mm	2.5 mm	180 mm	27,99	5	2628 G-180
2.5 mm	3.0 mm	200 mm	29,85	5	2628 G-200
1.8 mm	2.0 mm	160 mm	24,78	5	2628 G-160IP
2.0 mm	2.5 mm	180 mm	27,30	5	2628 G-180IP
2.5 mm	3.0 mm	200 mm	29,15	5	2628G-200IP

IP: Embalaje industrial

Alicates universales, cromados



**2628GC**

			€		
2.0 mm	1.8 mm	160 mm	19,78	5	2628 GC-160IP
2.5 mm	2.0 mm	180 mm	21,36	5	2628 GC-180IP
3.0 mm	2.5 mm	200 mm	23,49	5	2628 GC-200IP

IP: Embalaje industrial

Alicates universales, mangos bimateriales



**2630GC**

			€		
1.8 mm	2.0 mm	160 mm	20,38	5	2630GC-160IP
2.0 mm	2.5 mm	180 mm	20,54	5	2630GC-180IP
2.5 mm	3.0 mm	200 mm	23,49	5	2630GC-200IP

Alicates ERGO™ universales con boca semirredonda



**2629G**

			€		
160 mm	2.0 mm	1.8 mm	25,50	5	2629G-160
180 mm	3.0 mm	2.5 mm	27,90	5	2629G-180
200 mm	2.5 mm	2.0 mm	29,85	5	2629G-200
160 mm	2.5 mm	2.0 mm	24,78	5	2629G-160IP
180 mm	2.0 mm	1.8 mm	27,30	5	2629G-180IP
200 mm	3.0 mm	2.5 mm	29,15	5	2629G-200IP

IP: Embalaje industrial

Alicates universales, mangos recubiertos de PVC



**2628D**

			€		
2.0 mm	1.8 mm	160 mm	21,43	5	2628 D-160
2.5 mm	2.0 mm	180 mm	24,51	5	2628 D-180
3.0 mm	2.5 mm	200 mm	25,79	5	2628 D-200





Alicates universales, mangos recubiertos de PVC



**2630DC**

			€		
2.0 mm	1.8 mm	160 mm	<b>18,43</b>	5	2630DC-160IP
2.5 mm	2.0 mm	180 mm	<b>19,65</b>	5	2630DC-180IP
3.0 mm	2.5 mm	200 mm	<b>22,59</b>	5	2630DC-200IP

Alicates universales



**2678G**

			€		
1.7 mm	1.3 mm	160 mm	<b>16,56</b>	5	2678 G-160
2.0 mm	1.4 mm	180 mm	<b>17,61</b>	5	2678 G-180
2.5 mm	1.5 mm	205 mm	<b>19,03</b>	5	2678 G-200

Alicates universales, modelo americano



**2640D**

				€		
3.0 mm	2.7 mm	2.5 mm	160 mm	<b>19,80</b>	10	2640D-160
3.0 mm	2.7 mm	2.5 mm	180 mm	<b>22,43</b>	5	2640D-180
3.5 mm	3.0 mm	2.5 mm	200 mm	<b>25,20</b>	5	2640D-200

Alicate de abertura múltiple



**2970 G-200**

	€		
200 mm	<b>17,76</b>	5	2970G-200

**ALICATES DE MANIPULACIÓN**

Alicate de boca semirredonda



**2430G**

				€		
2.5 mm	1.8 mm	1.4 mm	140 mm	<b>27,90</b>	5	2430 G-140
3.0 mm	1.8 mm	1.6 mm	160 mm	<b>29,47</b>	5	2430 G-160
3.0 mm	1.8 mm	1.6 mm	200 mm	<b>33,80</b>	5	2430 G-200
2.5 mm	1.8 mm	1.4 mm	140 mm	<b>27,20</b>	5	2430 G-140 IP
3.0 mm	1.8 mm	1.6 mm	160 mm	<b>28,75</b>	5	2430 G-160 IP
3.0 mm	1.8 mm	1.6 mm	200 mm	<b>33,09</b>	5	2430 G-200 IP

IP: Embalaje industrial

Alicates universales para electricista



**2688D**

				€		
2.5 mm	3.0 mm	3.5 mm	250 mm	<b>42,81</b>	3	2688D-250

Alicates de boca semirredonda cromado



ergo



**2430GC**

				€		
2.5 mm	1.8 mm	1.4 mm	140 mm	<b>23,26</b>	5	2430 GC-140 IP
3.0 mm	1.8 mm	1.6 mm	160 mm	<b>24,32</b>	5	2430 GC-160 IP
3.0 mm	1.8 mm	1.6 mm	200 mm	<b>28,00</b>	5	2430 GC-200 IP

IP: Embalaje industrial

Alicates de boca semirredonda largos, boca recta



**2430D**

				€		
2.5 mm	1.8 mm	1.4 mm	140 mm	<b>24,68</b>	5	2430 D-140
3.0 mm	1.8 mm	1.6 mm	160 mm	<b>26,63</b>	5	2430 D-160
3.0 mm	1.8 mm	1.6 mm	200 mm	<b>28,86</b>	5	2430 D-200
2.5 mm	1.8 mm	1.4 mm	140 mm	<b>24,00</b>	5	2430 D-140 IP
3.0 mm	1.8 mm	1.6 mm	160 mm	<b>25,88</b>	5	2430 D-160 IP
3.0 mm	1.8 mm	1.6 mm	200 mm	<b>28,15</b>	5	2430 D-200 IP

IP: Embalaje industrial

Alicates ERGO™ de boca semirredonda sin filo de corte



ergo



**2431G**

	€		
125 mm	<b>26,35</b>	5	2431G-125
140 mm	<b>26,89</b>	5	2431G-140
160 mm	<b>27,38</b>	5	2431G-160
180 mm	<b>28,38</b>	5	2431G-180
125 mm	<b>25,85</b>	5	2431G-125IP
140 mm	<b>26,32</b>	5	2431G-140IP
160 mm	<b>26,77</b>	5	2431G-160IP
180 mm	<b>27,62</b>	5	2431G-180IP

IP: Embalaje industrial

Alicate de boca semirredonda



ergo



**4830, 4831**

	€		
135 mm	<b>44,03</b>	3	4830
135 mm	<b>46,82</b>	3	4831

Alicate de boca redonda



**C3830/C3840**

	€		
121 mm	<b>38,06</b>	10	C3830
121 mm	<b>37,31</b>	10	C3830IP
144 mm	<b>38,06</b>	10	C3840*
144 mm	<b>37,33</b>	10	C3840IP

IP: Embalaje industrial

Alicate de boca redonda



**C3630/C3640**

	€		
130 mm	<b>42,36</b>	10	C3630
130 mm	<b>41,51</b>	10	C3630IP
145 mm	<b>43,60</b>	10	C3640
145 mm	<b>42,61</b>	10	C3640IP

IP: Embalaje industrial

\* Hasta agotar existencias



Alicate de boca semirredonda



**2656S**

L	€	IP	IP
132 mm	67,10	1	2656 S

Alicates de boca semiredonda



**2470G**

Cu	Fe	Piano	L	€	IP	IP
3.0 mm	1.5 mm	1.0 mm	165 mm	18,85	5	2470 G-160
3.0 mm	1.5 mm	1.0 mm	210 mm	20,94	5	2470 G-200

Alicate de boca semirredonda extra largo



**158-N**

L	€	IP	IP
280 mm	38,25	12	158-N

Alicate de boca semirredonda, punta curva 45°



**2427G**

Cu	Fe	Fe+	L	€	IP	IP
3.0 mm	1.8 mm	1.6 mm	160 mm	30,35	5	2427 G-160
3.0 mm	1.8 mm	1.6 mm	200 mm	34,71	5	2427 G-200
3.0 mm	1.8 mm	1.6 mm	160 mm	29,63	5	2427 G-160 IP
3.0 mm	1.8 mm	1.6 mm	200 mm	34,02	5	2427 G-200 IP

IP: Embalaje industrial

Alicates de boca semirredonda, punta curva 45° - cromados



**2427GC**

Cu	Fe	Fe+	L	€	IP	IP
3.0 mm	1.8 mm	1.6 mm	160 mm	25,30	5	2427 GC-160IP
3.0 mm	1.8 mm	1.6 mm	200 mm	28,98	5	2427 GC-200IP

Alicates de boca semirredonda, punta curva 45°



**2427D**

Cu	Fe	Fe+	L	€	IP	IP
3.0 mm	1.8 mm	1.6 mm	160 mm	27,82	5	2427 D-160
3.0 mm	1.8 mm	1.6 mm	200 mm	30,08	5	2427 D-200

Alicates de boca semirredonda, punta curva 60°



ergo®



**4833**

	€		
130 mm	48,41	3	4833

Alicate de manipulación punta curvada 60°



**2656R**

	€		
129 mm	83,79	1	2656 R

Alicate con punta de aguja, punta curva 45°



**C3745**

	€		
141 mm	40,33	10	C3745
141 mm	39,67	10	C3745IP

IP: Embalaje industrial

Alicates de boca semirredonda, curvados



**2477G-200**

				€		
3.0 mm	1.5 mm	1 mm	165 mm	18,42	5	2477G-160
3.0 mm	1.5 mm	1 mm	210 mm	23,34	5	2477 G-200

Alicate con punta de aguja, punta curva 90°



**C3790**

	€		
125 mm	40,71	10	C3790
125 mm	39,67	10	C3790IP

IP: Embalaje industrial

Alicate de boca semicircular extra largo



**158-NB**

	€		
270 mm	39,80	12	158-NB



Alicates de boca plana



**2420G**

↔ L ↔	€		
125 mm	27,15	5	2420 G-125
125 mm	21,98	5	2420G-125IP

IP: Embalaje industrial

Alicates de boca plana



**2421G**

↔ L ↔	€		
140 mm	28,70	5	2421 G-140
160 mm	31,54	5	2421 G-160
180 mm	37,88	5	2421 G-180
140 mm	27,97	5	2421 G-140IP
160 mm	30,80	5	2421 G-160 IP
180 mm	37,16	5	2421 G-180 IP

IP: Embalaje industrial

Alicates de boca plana - cromados



**2421GC**

↔ L ↔	€		
140 mm	23,46	5	2421GC-140IP
160 mm	25,79	5	2421GC-160IP
180 mm	26,15	5	2421GC-180IP

IP: Embalaje industrial

Alicates de boca plana, mangos recubiertos de PVC



**2421D**

↔ L ↔	€		
140 mm	23,49	5	2421 D-140IP
160 mm	25,89	5	2421 D-160IP
180 mm	30,89	5	2421 D-180IP

IP: Embalaje industrial

Alicate para conectores



**7835G**

			↔ L ↔	€		
3.0 mm	1.8 mm	1.6 mm	160 mm	45,84	5	7835 G-160

Alicates de boca plana



**4430**

↔ L ↔	€		
135 mm	42,31	3	4430



Alicate de boca plana



**C3430**

← L →	€		
129 mm	37,70	10	C3430
129 mm	37,28	10	C3430IP

IP: Embalaje industrial

Alicate de boca plana



**2646MF**

← L →	€		
120 mm	72,71	1	2646 MF

Alicates de boca plana



**2471G**

← L →	€		
180 mm	18,55	5	2471 G-180
165 mm	17,25	5	2471 G-160

Alicate para tuercas



**2979D**

← L →	€		
180 mm	42,31	5	2979 D-180

Alicate de boca redonda



ergo®



**2521G**

← L →	€		
140 mm	28,48	5	2521 G-140
160 mm	31,38	5	2521G-160
140 mm	28,86	5	2521G-140IP
160 mm	29,45	5	2521 G-160 IP

IP: Embalaje industrial

Alicate de boca redonda, mangos recubiertos de PVC



**2521D**

← L →	€		
140 mm	20,58	5	2521D-140IP
160 mm	24,25	5	2521D-160IP

IP: Embalaje industrial



Alicates de boca redonda



ergo



**4530**

L	€	Icon	Icon	Code
135 mm	44,65			3 4530

Alicate de boca redonda



**C3530**

L	€	Icon	Icon	Code
127 mm	38,06			10 C3530
127 mm	37,28			10 C3530IP

IP: Embalaje industrial

Alicate de boca semirredonda



**2646MS**

L	€	Icon	Icon	Code
120 mm	80,61			1 2646 MS



**BAHCO**

TENACILLAS ARTICULADAS

Tenacillas articuladas ajustables ERGO™



ergo



**8223 - 8226**

L	€	Icon	Icon	Code
210 mm	48,41			4 8223
250 mm	57,00			4 8224
315 mm	77,92			4 8225
400 mm	86,80			1 8226
210 mm	47,72			4 8223 IP
250 mm	56,31			4 8224 IP
315 mm	77,23			4 8225 IP

IP: Embalaje industrial

Tenacillas articuladas ajustables ERGO™



ergo



**8224/8225C**

L	€	Icon	Icon	Code
250 mm	35,98			4 8224CIP
315 mm	48,01			4 8225CIP

Tenacilla articulada ajustable de gran apertura



ergo



**8231**

max	L	€	Icon	Icon	Code
51 mm	225 mm	51,13			4 8231
51 mm	225 mm	50,44			4 8231 IP

IP: Embalaje industrial

Tenacilla articulada de ajuste rápido



**7223-7225**

max	L	€		
45 mm	200 mm	34,32	4	7223
63 mm	250 mm	35,46	4	7224
70 mm	300 mm	44,65	8	7225
45 mm	200 mm	32,54	8	7223IP
63 mm	250 mm	33,77	4	7224IP
70 mm	300 mm	42,97	4	7225IP

IP: Embalaje industrial

Tenacilla articulada de ajuste rápido con mangos de pvc



**7223D\_7225D**

	L	€		
16	200 mm	33,16	8	7223D*
25	300 mm	43,60	4	7225D*
16	200 mm	31,93	8	7223D IP*
25	300 mm	42,61	4	7225D IP*

IP: Embalaje industrial

Tenacilla de apertura múltiple de canal



**6224**

	L	€		
11	250 mm	33,16	4	6224

ISO 8976

Tenacilla articulada ajustable con mangos de pvc



**6221D-6225D**

	L	€		
6	125 mm	21,49	10	6221D
8	150 mm	22,84	10	6222D
10	200 mm	23,34	8	6223D
11	250 mm	20,88	5	6224D
13	300 mm	36,86	10	6225D
6	125 mm	21,12	10	6221D IP
8	150 mm	22,43	10	6222D IP
10	200 mm	22,97	8	6223D IP
11	250 mm	20,48	5	6224D IP
13	300 mm	36,44	5	6225D IP

IP: Embalaje industrial

Tenacilla de ajuste rápido



**2971G**

max	L	€		
35 mm	250 mm	16,00	5	2971G-250

Tenacilla de ojal



**221 D - 225 D**

L	€		
117 mm	15,16	5	221 D
150 mm	15,68	5	222 D
192 mm	16,71	5	223 D
240 mm	18,84	5	224 D
305 mm	28,82	5	225 D

\* Hasta agotar existencias



Tenacilla articulada



**5223 - 5226 DC**

		€		
105 mm	400 mm	56,39	1	5226 DC*

Juego de 3 tenacillas articuladas



**7224-622XD-3P**

			€		
75 x 50 x 260 mm	3	813 g	90,67	1	7224-622XD-3P

Alicate para terminales



**2650**

		€		
65 mm	235 mm	74,88	1	2650
	235 mm	6,66	1	2650 B

2650 B: Mordaza de plástico para 2650

6221D, 6224D

7224

**ALICATES PARA ARANDELAS**

Alicates para arandelas interiores



**2800**

			€		
8-13 mm	0.8 mm	140 mm	20,28	3	2800-140
12-25 mm	1.2 mm	150 mm	20,28	3	2800-150
19-60 mm	1.7 mm	180 mm	23,15	3	2800-180
40-100 mm	2.2 mm	225 mm	29,15	3	2800-225
85-165 mm	3.1 mm	310 mm	39,96	1	2800-300

Juego de 3 tenacillas articuladas



**622-3P**

			€		
110 x 50 x 390 mm	3	1260 g	94,43	1	622-3P





Alicates para arandelas interiores boca curvada 90°



**2890**

			€		
8-15 mm	0.8 mm	127 mm	17,58	3	2890-125
12-25 mm	1.2 mm	127 mm	20,60	3	2890-140





6223D, 6224D, 6225D

			€		
19-60 mm	1.7 mm	180 mm	<b>23,90</b>	3	2890-180
40-100 mm	2.2 mm	210 mm	<b>30,08</b>	3	2890-210
85-165 mm	3.1 mm	300 mm	<b>44,93</b>	1	2890-300

### Alicates para arandelas interiores







#### 2461

			€		
8-25 mm	1.0-2.0 mm	140 mm	<b>73,50</b>	1	2461 C8
19-60 mm	2.0-2.5 mm	180 mm	<b>76,17</b>	1	2461 C19
40-100 mm	2.5-3.5 mm	255 mm	<b>87,61</b>	1	2461 C40

### Alicates para arandelas interiores







#### 2463





			€		
8-25 mm	1.0-2.0 mm	130 mm	<b>64,16</b>	1	2463 D8
19-60 mm	2.0-2.5 mm	170 mm	<b>78,13</b>	1	2463 D19
40-100 mm	2.5-3.5 mm	210 mm	<b>89,81</b>	1	2463 D40

### Alicates para arandelas exteriores



#### 2900





			€		
3-10 mm	0.8 mm	140 mm	<b>21,63</b>	3	2900-140
10-25 mm	1.2 mm	150 mm	<b>21,63</b>	3	2900-150

			€		
19-60 mm	1.7 mm	180 mm	<b>23,61</b>	3	2900-180
40-100 mm	2.2 mm	215 mm	<b>29,15</b>	3	2900-215
85-165 mm	3.1 mm	300 mm	<b>45,55</b>	1	2900-300

### Alicates para arandelas exteriores bocas curvadas 90°







#### 2990

			€		
3-10 mm	0.8 mm	12 mm	<b>22,16</b>	3	2990-125
10-25 mm	1.2 mm	127 mm	<b>22,16</b>	3	2990-140
19-60 mm	1.7 mm	180 mm	<b>24,90</b>	3	2990-180
40-100 mm	2.2 mm	200 mm	<b>30,08</b>	3	2990-200
85-165 mm	3.1 mm	300 mm	<b>44,34</b>	1	2990-300

### Alicates para arandelas exteriores



#### 2464

			€		
3-10 mm	1.0-1.5 mm	120 mm	<b>79,41</b>	1	2464 A3
10-25 mm	1.5-2.0 mm	120 mm	<b>79,41</b>	1	2464 A10
19-60 mm	2.0-2.5 mm	180 mm	<b>86,39</b>	1	2464 A19
40-100 mm	2.5-3.0 mm	210 mm	<b>94,78</b>	1	2464 A40

\* Hasta agotar existencias





Alicates para arandelas exteriores



**2466**

Ø	±	L	€	📦	🐟
3-10 mm	1.0-1.5 mm	130 mm	<b>80,96</b>	1	2466 B3
10-25 mm	1.5-2.0 mm	130 mm	<b>80,96</b>	1	2466 B10
19-60 mm	2.0-2.5 mm	165 mm	<b>88,48</b>	1	2466 B19
40-100 mm	2.5-3.0 mm	190 mm	<b>99,63</b>	1	2466 B40

Alicate para arandelas interiores y exteriores



**2928**

Ø	±	L	€	📦	🐟
7-26 mm	3-26 mm	160 mm	<b>58,85</b>	1	2928-160
10-51 mm	7-51 mm	200 mm	<b>83,08</b>	1	2928-200
46-102 mm	38-102 mm	250 mm	<b>118,82</b>	1	2928-250

Puntas de repuesto para series 2928



**2928-1 - 4**

🐟	€	📦	🐟
2928-160	<b>15,84</b>	1	2928-1
2928-200	<b>15,84</b>	1	2928-2
2928-250	<b>15,84</b>	1	2928-3
2928-250	<b>15,84</b>	1	2928-4

Alicates para arandelas exteriores



**2460**

L	€	📦	🐟
175 mm	<b>54,44</b>	1	2460

Alicates especiales para arandelas ciegas



**2465D**

L	€	📦	🐟
200 mm	<b>60,57</b>	1	2465D-200

Juego 4 alicates para arandelas



**28-29/S4**

g	€	📦	🐟
740 g	<b>110,56</b>	1	28-29/S4

2900-180	🐟	🐟
2800-180	🐟	🐟
2990-180	🐟	🐟
2890-180	🐟	🐟

Juego de alicates para arandelas interiores y exteriores



**9938**

	€		
1640 g	222,69	1	9938

2928-160, 2928-200, 2928-250



**PELACABLES Y HERRAMIENTAS PARA DESMONTAJE**

Pelacables



**2223G**

		€		
0.5-5 mm	165 mm	29,47	5	2223 G-150

Pelacables



**2223D**

		€		
0.5-5 mm	165 mm	29,99	5	2223 D-150

Pelacables automático



**3416 B**

		€		
0,02-10 mm <sup>2</sup>	34-8 AWG	157,29	10	3416 B

Pelacables automático



**3416 A**

		€		
0,2-6 mm <sup>2</sup>	24-10 AWG	45,41 17,18	6 1	3416 A 3416 A SH

SH: Hoja de repuesto



Pelacables automático



**3418 A**

				€		
20-10 AWG	0,5-6 mm <sup>2</sup>	3 mm	160 mm	<b>36,25</b>	1	3418 A



Pelacables giratorio



**3518 A**

		€		
4-28 mm	185 mm	<b>25,06</b> <b>5,87</b>	1	3518 A 3518 A SH



SH: hoja de repuesto

Pelacables giratorio



**3520 B**

		€		
4,5-40 mm	167 mm	<b>106,72</b> <b>30,58</b>	10	3520 B 3520 B SH



SH: hoja de repuesto

Pelacables universal con cuchilla retráctil



**3518 B**

		€		
0,5-6 mm <sup>2</sup>	125 mm	<b>45,68</b>	1	3518 B



Pelacables



**3520 A**

	€		
0,5-6 mm <sup>2</sup>	<b>34,75</b> <b>5,84</b>	1	3520 A 3520 A SH



3520 A SH: Hoja de repuesto

Pelacables para cables planos y redondos



**3517 A**

		€		
6-13 mm	120 mm	<b>35,94</b>	1	3517 A



Herramienta de pelado para cables de datos de PVC



**3717 A**

			€		
115 mm	4.5-10 mm mm	28 g	28,39	1	3717 A

Herramienta de pelado de precisión



**3719 A**

			€		
0,12-0,8 mm mm	36-20 AWG	112 mm	40,55	12	3719 A

Pelacables Coaxial



**3417 A**

		€		
4.8-7.5 mm	110 mm	30,02	12	3417 A

Herramienta de inserción para bloques LSA



**3718 A**

			€		
185 mm	0,7-2,6 mm	60 g	52,72	12	3718 A

Pelacables de precisión



**3619 A**

		€		
2,5-11 mm	91 mm	53,91 14,62	10	3619 A 3619 A SH

SH: hoja de repuesto

Pelacables autoajustable standar



**3419 B**

	€		
0.25-6.00 mm	122,89 37,27	1	3419 B 3419 B SH

SH: hoja de repuesto



## ALICATES PARA TERMINALES

Alicates para terminales aislados



### CR B 01

	<b>AWG</b>		€		
0.50-6.00 mm <sup>2</sup>	20-10	220 mm	28,45	60	CR B 01

Alicates para terminales NO aislados



### CR B 02

	<b>AWG</b>		€		
1.50-6.00 mm <sup>2</sup>	14-10	220 mm	27,37	60	CR B 02

Alicates para terminales no aislados tipo faston



### CR B 03

	<b>AWG</b>		€		
1.50-6.00 mm <sup>2</sup>	14-10	220 mm	27,85	60	CR B 03

Alicates para terminales tubulares



### CR B 05

	<b>AWG</b>		€		
0.5-2.5 mm <sup>2</sup>	20-14	140 mm	55,37	2	CR B 05

Alicates para terminales tubulares



### CR B 06

	<b>AWG</b>		€		
0.5-16 mm <sup>2</sup>	20-6	220 mm	110,73	2	CR B 06

Alicates de carraca para terminales para conectores aislados, perfil ovalado



### CR OV 01

	<b>AWG</b>		€		
0.5-6.0 mm <sup>2</sup>	20-10	256 mm	162,19	1	CR OV 01



Alicate de carraca desembragable para terminales aislados



**CR W 01**

	<b>AWG</b>		€		
0.5-6.0 mm <sup>2</sup>	20-10	225 mm	160,22	1	CR W 01

Alicate de carraca desembragable para terminales de cable coaxial BNC-TNC



**CR W 04**

			€		
RG 58-59-62 mm <sup>2</sup>		225 mm	139,85	1	CR W 04

Alicate de carraca desembragable para terminales NO aislados



**CR W 02**

	<b>AWG</b>		€		
0.5-10 mm <sup>2</sup>	20-8	225 mm	133,76	1	CR W 02

Alicate de carraca desembragable para terminales tubulares



**CR W 05**

<b>AWG</b>			€		
0.5-4.0		225 mm	142,02	1	CR W 05

Alicate de carraca desembragable para terminales NO aislados de barril abierto



**CR W 03**

	<b>AWG</b>		€		
0.5-6.0 mm <sup>2</sup>	20-10	225 mm	133,76	1	CR W 03

Alicate de carraca desembragable para terminales tubulares



**CR W 06**

<b>AWG</b>			€		
6-16		225 mm	150,10	1	CR W 06



Alicates autoajustables para terminales, perfil cuadrado



**CR SA S01**



AWG	L	€	Icon 1	Icon 2
0.14-10 mm <sup>2</sup>	26-8	176 mm	218,96	1 CR SA S01

Alicates autoajustables para terminales, perfil hexagonal



**CR SA H01**



AWG	L	€	Icon 1	Icon 2
0.14-10 mm <sup>2</sup>	26-8	176 mm	225,91	1 CR SA H01
0.14-16 mm <sup>2</sup>	26-6	176 mm	247,66	1 CR SA H16

Alicates autoajustables para terminales, perfil trapezoidal



**CR SA T01**



AWG	L	€	Icon 1	Icon 2
0.14-10 mm <sup>2</sup>	26-8	180 mm	214,32	1 CR SA T01

Prensa terminales, terminales NO aislados



**CR L 01**

AWG	L	€	Icon 1	Icon 2
10-120 mm <sup>2</sup>	10-95 mm <sup>2</sup>	600 mm	410,64	1 CR L 01

Matriz ajustable 9 secciones de compresión

Prensa terminales "heavy duty" para terminales no aislados



**CR L 02**

AWG	L	€	Icon 1	Icon 2
6-50 mm <sup>2</sup>	360 mm	303,30	1	CR L 02

Capacidad mm<sup>2</sup> 6-10-16-25-35-50 No utilizar bajo tensión eléctrica

Prensa terminales, terminales no aislados prensado huella hexagonal



**CR L 03**

AWG	L	€	Icon 1	Icon 2
25-150 mm <sup>2</sup>	650 mm	461,98	1	CR L 03

Capacidad mm<sup>2</sup> 25-35-50-70-95-120-150 No utilizar bajo tensión eléctrica

## JUEGOS DE ALICATES

Juego de alicates para mecánica de precisión



ergo®



**9733**

30 x 215 x 215 mm € 8 398,28 1 9733

4130, 4131	
4239	
4830	
4530	
4231	
4430	
4833	

Juego de alicates de precisión



**C3902/3**

€ 3 116,39 1 C3902/3

C3330R	
C3840	
C3745	

Juego de alicates compactos y destornilladores, 8 piezas



**C3903/2-6**

€ 8 117,03 1 C3903/2-6

C3330R	
C3840	
700-1.5-50, 700-2-50, 700-2.5-50, 700-3-50	
701-0-50, 701-1-75	

Juego de llave ajustable y tenacilla



ergo®



**9031-8224**

€ 2 693 g 89,02 3 9031-8224

9031	
8224	

Pack 2 herramientas para fontanero



ergo®



**9873**

€ 25 x 190 x 280 mm 2 55,98 1 9873

9072 P	
8224	



Juego 3 herramientas



ergo®



9853

		€		
25 x 252 x 292 mm	3	82,96	1	9853

9071

2101G-160

8224



1€

Juego de 4 alicates



ergo®



9897

		€		
4	1030 g	140,42	1	9897

8224

2628 G-180

2101G-160

2430 G-160



1€

Juego de alicates universales ERGO™ (3 piezas)



ergo®



9897G/3

			€		
3	50 x 180 x 400 mm	788 g	84,45	1	9897G/3

2628 G-180

2101G-160

2430 G-200



MORDAZAS DE PRESION

Mordaza grip bocas curvas, con cortante



2951

		€		
1.2 mm	140 mm	18,67	1	2951-140
2 mm	190 mm	25,52	1	2951-180
3 mm	235 mm	29,40	1	2951-250
4 mm	300 mm	49,48	1	2951-300

Mordaza grip, bocas curvas sin cortante



2953

	€		
140 mm	17,44	1	2953-140
190 mm	23,19	1	2953-200
235 mm	26,46	1	2953-250
300 mm	45,73	1	2953-300

Mordaza con bocas rectas



**2958**

← L →	€		
135 mm	18,51	1	2958-140
190 mm	25,52	1	2958-200
235 mm	29,40	1	2958-250

Mordaza grip de punta larga y mordaza fina



**2952**

← L →	€		
155 mm	22,23	1	2952-165
230 mm	31,74	1	2952-235

Mordaza grip bocas recta y convexa



**2968**

← L →	€		
205 mm	25,52	1	2968-190
235 mm	29,40	1	2968-235

Mordazas grip para planchas de metal con Acabado en Niquel



**2967**

← L →	€		
180 mm	40,45	1	2967-180

Mordaza grip Omnium



**2957**

← L →	€		
250 mm	27,84	1	2957-250

Mordazas grip con bocas paralelas



**2955**

← L →	€		
235 mm	33,44	1	2955-250





Grips de cadena con Acabado en Níquel



**2999**

L	€		
230 mm	50,08	1	2999-250
500 mm	14,74	1	2999-SHN

2999-SH: Cadena de repuesto

Cortatubo de cadena



**2998**

L	€		
240 mm	94,73	1	2998-250
330 mm	55,26	1	2998-SHN

2998-SH: Cadena de repuesto

Mordaza para mesa



**2960**

L	€		
280 mm	55,88	1	2960-280

Mordaza grip con sujeción C



**2963**

L	€		
283 mm	39,05	1	2963-280
458 mm	64,09	1	2963-450
580 mm	77,07	1	2963-630

Mordaza grip con sujeción C paralela



**2964**

L	€		
175 mm	32,20	1	2964-160
280 mm	42,46	1	2964-280
436 mm	71,70	1	2964-450
625 mm	83,98	1	2964-600

Grip con dos bocas autoadaptables



**2950**

L	€		
235 mm	35,00	1	2950-250

Mordaza de acero delgada, almohadillas giratorias



**2956**

	€		
282 mm	46,05	1	2956-290

Mordaza grip para tubos



**2966**

	€		
290 mm	45,57	1	2966-280

Mordazas grip cpm sujeción C



**2962**

	€		
290 mm	58,58	1	2962-8-150
290 mm	75,28	1	2962-8-230
290 mm	81,66	1	2962-8-300

Repuestos para mordazas



**2951-S**

			€		
	43 mm	15 g	3,73	1	2951-S05
	46 mm	25 g	3,73	1	2951-S07
	62 mm	50 g	3,73	1	2951-S10
	87 mm	70 g	3,73	1	2951-S12

Mordaza grip para soldadura tipo U



**2965**

	€		
228 mm	33,60	1	2965-200
290 mm	44,50	1	2965-280

Grip universal, mordazas largas, 4 posiciones



**2997**

	€		
255 mm	77,14	5	2997-300



Grip universal, mordazas cortas, 4 posiciones



**2997-250**

	€		
235 mm	70,01	1	2997-250

Tenazas de ajuste rápido



**2949**

	€		
193 mm	64,18	1	2949-190IP
196 mm	68,08	1	2949-200IP
240 mm	71,36	1	2949-240IP
240 mm	88,65	1	2949-250IP

Husillo de respuesta: 2949-xxxSH IP: Embalaje industrial

Tornillo de recambio para tornillos de banco



**2949-L**

		€		
2949-190IP	75 mm	5,89	1	2949-L075
2949-200IP, 2949-240IP	120 mm	6,14	1	2949-L120
2949-250IP	200 mm	7,55	1	2949-L200

**REMACHADORAS**

Remachadora con cabeza giratoria



**2681**

	€		
285 mm	41,69	12	2681

Remachadora manual



**1467-250**

	€		
255 mm	63,44	1	1467-250

Alicates de muescas



**2690**



200 mm

€



60,05 10 2690

Respuestos para remachadora 1467



**1467**



10 g  
10 g

€



19,75 1 1467-LJ  
16,03 1 1467-SJ

Remachadora de brazos largos



**1467-520**



530 mm

€



205,94 1 1467-520

Juego de repuestos para 2681



**2681-1**



15 g

€



3,56 1 2681-1

Remachadora extensible, mm



**1467-320-850**



850 mm

€

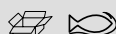

266,55 1 1467-320-850

**ALICATES ESPECIALES**

Herramienta tensora para abrazaderas de Nylon, tipo pistola



**790450A**



<2.2x5 mm

€



67,96 1 790450A

Tensa hasta 5mm de ancho y grosor 1,6mm



Herramienta tensora para abrazaderas de Nylon (Bridas)

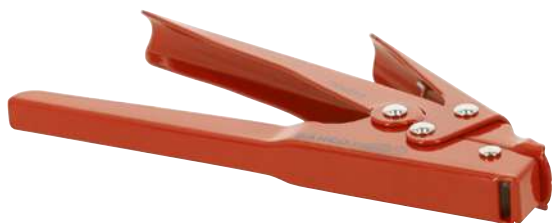

**790455A**

	€		
<9.5x2.3 mm	57,71	1	790455A

Tensa hasta 9,5mm de ancho y grosor 2,3mm

Alicate trenzador



**2855**



	€		
236 mm	159,00	1	2855
287 mm	201,28	1	2855 D

Capacidad: Cables hasta Ø1,04 mm para el 2855 y Ø1,6 mm para el 2855 D

Alicate trenzador de alambre



**2856**



	€		
203 mm	323,95	1	2856-8*
268 mm	323,95	1	2856-10*

\* Hasta agotar existencias





## Llaves para tubos y herramientas para fontanería



## LLAVES PARA TUBOS

Llave para tubo de ajuste rápido



ergo®



### 1610/1620

L	max	€		
320 mm	1 in	81,06	1	1610
430 mm	1 1/2 in	110,27	1	1620

10 veces más rápido que el modelo estándar

Llave para tubo modelo sueco, 90°



ergo®



### 1410/1420

L	max	€		
320 mm	1 in	79,40	1	1410
430 mm	1 1/2 in	106,83	1	1420

Llave para tubo modelo sueco 90°  
ERGO™ con cómodo mango ERGO™



ergo®



### 1410D/1420D

L	max	€		
320 mm	1 in	88,46	1	1410D
430 mm	1 1/2 in	118,97	1	1420D

Llave para tubo modelo sueco, 90°



### 140-147

L	max	€		
210 mm	3/4 in	56,49	1	140
320 mm	1 in	63,53	1	141
426 mm	1 1/2 in	85,45	1	142
557 mm	2 1/2 in	139,54	1	143
722 mm	3 1/2 in	232,48	1	144
1060 mm	5 in	448,01	1	147

Llave de tubo de esquina, 45°



### 442 B-444 B

L	max	€		
320 mm	1 in	69,91	1	442 B
430 mm	2 in	82,64	1	443 B
545 mm	2 1/2 in	111,20	1	444 B

Llave para tubo combinada modelo sueco,  
45°



### 341-344

L	max	€		
230 mm	1/2 in	54,45	1	341
330 mm	1 in	61,26	1	342
420 mm	1 1/2 in	82,40	1	343
530 mm	2 in	123,32	1	344

Tuerca de repuesto para llaves de tubo de  
ajuste rápido



### 1610-nut/1620-nut

Ø	g	€		
11 mm	34 g	12,86	1	1610-NUT
11.5 mm	48 g	15,05	1	1620-NUT

Llave para tubo modelo sueco, 90°



### DOW175

L	max	€		
310 mm	1 in	40,75	1	DOW 175-1
420 mm	1 1/2 in	55,92	1	DOW 175-11/2
560 mm	2 in	87,67	1	DOW 175-2
630 mm	3 in	146,07	1	DOW 175-3

Llave de tubo combinada modelo sueco,  
45°



### DOW177

L	max	€		
325 mm	1 in	50,57	1	DOW 177-1/2-1
425 mm	1 1/2 in	64,26	1	DOW 177-11/2
534 mm	2 in	96,02	1	DOW 177-2

Llave para tubo de esquina modelo sueco, 45°



**DOW176**

L	max	€		
330 mm	1 in	53,01	1	DOW 176-1
415 mm	1 1/2 in	68,14	1	DOW 176-11/2
530 mm	2 in	93,80	1	DOW 176-2

Llaves para tubo de cadena para trabajos pesados



**372**

L	€		
1.1 in	116,73	1	372-1.1/2
2.1 in	215,97	1	372-2.1/2
4 in	275,33	1	372-4
6 in	473,05	1	372-6
8 in	640,24	1	372-8
12 in	1.101,39	1	372-12

LLave de cinta



**375**

L	€		
300 mm	48,44	1	375-8

Llave Stillson de aluminio



**380**

L	max	€		
253 mm	1.1/2 in	46,49	1	380-10
320 mm	2 in	61,80	1	380-14
455 mm	2.1/2 in	88,28	1	380-18
607 mm	3 in	147,08	1	380-24
910 mm	4 in	284,48	1	380-36
1210 mm	6 in	418,87	1	380-48

Cadena de repuesto para llaves con cadena



**3074**

L		€		
340 mm	372-1.1/2	35,18	1	307401B
475 mm	372-2.1/2	52,60	1	307411B
700 mm	372-4	84,82	1	307421B
850 mm	372-6	140,93	1	307431B
1000 mm	372-8	192,19	1	307441
1400 mm	372-12	281,87	1	307451

Llave para tuercas de lavabo



**363**

L	€		
280 mm	48,44	1	363-32

Llave Stillson para tubos



**361**

L	max	€		
185 mm	1 in	30,72	1	361-8
230 mm	1.1/2 in	34,17	1	361-10
265 mm	1.3/4 in	39,85	1	361-12
315 mm	2 in	42,72	1	361-14
450 mm	2.1/2 in	59,78	1	361-18
535 mm	3 in	99,35	1	361-24
900 mm	4 in	191,26	1	361-36

Llave de cadena para tubo



**370**

L	€		
300 mm	48,44	1	370-4

**HERRAMIENTAS DE CORTATUBOS**

Cortatubos 16 mm



**401-16**

	€		
3-16 mm	32,01	12	401-16



Cortatubos 28 mm



**401-28**

∅	€	📦	🐟
3-28 mm	32,01	12	401-28

Cortatubos automático



**306-**

∅	€	📦	🐟
10 mm	32,30	1	306-10
12 mm	34,13	1	306-12
15 mm	35,94	12	306-15
22 mm	39,52	12	306-22

Cortatubos



**302-35**

∅	€	📦	🐟
3-35 mm	42,77	6	302-35

Cortatubos 35 mm



**402-35**

∅	€	📦	🐟
3-35 mm	57,50	6	402-35

Cortatubos



**301-16**

∅	L	€	📦	🐟
3-16 mm	72 mm	28,18	12	301-16

Cortatubos



**302-76**

∅	€	📦	🐟
	6,30	1	302-76-95*

Cortatubos 76 mm



**402-76**

∅	€	📦	🐟
12-76 mm	117,63	6	402-76*

Cortatubos



**301-22**

∅	€	📦	🐟
3-28 mm	26,90	12	301-22

Corta tubos con sistema de ajuste rápido



**302-76N**

∅	L	€	📦	🐟
12-76 mm	318 mm	97,38	6	302-76N

Discos de corte de repuesto para cortatubos de la serie 301/302 y 401/402



**302/402-15-95**

g	€			
301-16,301-22,302-35,302-75N	5 g	6,55	100	302-15-95
401-16,401-28,402-35,402-75	5 g	9,73	1	402-15-95

Arandelas/pin para juego 401/402



**402-95-SET**

g	€			
30 g	37,89	1		402-95-SET

Cortatubos para PEX



**412-28-PEX**

g	€			
28 mm	60,27	5		412-28-PEX

Juego de discos y pin de repuesto para llaves de pipa 301/302, 4 piezas



**302-95-SET**

g	€			
30 g	25,62	1		302-95-SET

Cortador para tubos de plástico



**311-32**

g	€			
32 mm	22,28	6		311-32

Cortatubos para multicapa



**412-26-MULTI**

g	€			
26 mm	88,14	5		412-26-MULTI

Recambio de disco de corte



**306-15-95**

g	€			
10 g	12,42	1		306-15-95

Cortatubos de plástico



**411**

g	€			
26 mm	47,00	4		411-26
35 mm	61,48	4		411-35
42 mm	80,62	6		411-42
63 mm	118,60	5		411-63

Hojas de repuesto para tijeras de plástico



**411-95**

g	€			
1	39 g	17,45	50	411-26-95
1	37 g	27,36	50	411-35-95
1	41 g	32,34	50	411-42-95
1	48 g	61,17	30	411-63-95

\* Hasta agotar existencias





Hojas de repuesto para 412-28-PEX



**412-28-PEX-95**

		€		
1	35 g	20,83	30	412-28-PEX-95

Hojas de repuesto para 412-26-MULTI



**412-26-MULTI-95**

		€		
1	10 g	20,93	150	412-26-MULTI-95

**HERRAMIENTAS DE DOBLADO Y CONFORMADO**

Curva-tubos



**1084**

		€		
250 mm	6,8 10 mm	89,65	5	1084

Dobladora de tubos



**500**

	€		
12 mm	124,15	1	500-12
14 mm	133,10	1	500-14
15 mm	137,23	1	500-15
16 mm	143,76	1	500-16
18 mm	169,26	1	500-18
22 mm	193,96	1	500-22

Abocinador en métrica



**4480MM**

		€		
45°	4, 6, 8, 10, 12, 14, 16, 18 mm	61,49	1	4480MM

Abocinador en pulgadas



**4480IM**

		€		
45°	5/8, 3/16, 1/4, 5/16, 3/8, 7/16, 1/2, 3/4 in	61,49	1	4480IM

Juego de abocinador y corta-tubos



**4480/**

	€		
45 x 140 x 330 mm	160,35	1	4480/2-ZD

**HERRAMIENTAS DE REBABADO**

Rebador



**316-1**

	€		
143 mm	13,78	12	316-1

Rebador



**316-2**

	€		
150 mm	20,65	12	316-2

Rebador: recambio de 316-2



**316-2-95**

	€		
3 g	10,88	1	316-2-95

Rebador interno/externo



**318-38/318-54**

	€		
8-38 mm	86,70	1	318-38
10-54 mm	138,91	1	318-54

Rebador interno/externo



**317-40**

	€		
3-40 mm	13,88	12	317-40





**BAHCO®**



## Herramientas neumáticas



## PISTOLAS DE IMPACTO NEUMÁTICAS

Llave de impacto mini con cuadradillo de 3/8"



**BP704**

**BAR** €   
6.3 bar 1500 min 218,70 1 BP704

Llave de impacto acodada 1/2"



**BP814A**

**BAR** €   
7000 min 6.2 bar 511,67 10 BP814A

Llave de impacto neumática compacta 1/2"



**BP814**

**BAR** €   
10,000 min 6.3 bar 262,57 10 BP814\*

Diam manguera 10mm Par máx 410Nm

Llave de impacto neumática 1/2"



**BP815**

**BAR** €   
7,000 min 6.3 bar 262,57 1 BP815

Diam manguera 10mm Par máx 825Nm

Juego llave BP815 con 11 vasos, mm



**BP815K1**

**BAR** €   
7,000 min 6.3 bar 383,76 1 BP815K1\*

**BP815**

K7800M-10, K7800M-11, K7800M-12, K7800M-13, K7800M-14, K7800M-15, K7800M-17, K7800M-19, K7800M-22, K7800M-24, K7800M-21

PM5142

Mini llave de impacto neumática 1/2"



**BPC813**

**BAR** €   
10000 min 6.3 bar 262,57 10 BPC813

Diam. manguera 10mm. Par máx. 678Nm

Juego mini llave de impacto con vasos ultra cortos



**BPC813K1**

**BAR** €   
1/2 in 65 x 162 x 215 mm 354,47 1 BPC813K1\*

**BPC813**

K7800M-13, K7800M-14, K7800M-16, K7800M-17, K7800M-19, K7800M-21, K7800M-22, K7800M-24

Llave de impacto neumática compacta 1/2"



**BPC814**

**BAR** €   
12000 min 6,3 bar 302,97 10 BPC814

Diam. manguera 10mm. Par máx. 678Nm

Llave de impacto neumática 1/2" alta potencia



**BPC815**

**BAR** €   
8000 min 6,3 bar 316,43 1 BPC815

Diam. manguera 10mm. Par máx. 1.112Nm



Juego llave BPC815 con 11 vasos, mm



**BPC815K1**

		€		
1/2 in	90 x 230 x 390 mm	<b>609,96</b>	1	BPC815K1*

**BPC815**

K7801Z-1/2, K7801Z-5/8, K7801Z-3/4, K7801Z-7/8, K7801Z-15/16

Juego llave BPC815 con 5 vasos, mm



**BPC815K2**

		€		
1/2 in	90 x 230 x 320 mm	<b>522,62</b>	1	BPC815K2

**BPC815**

K7801M-10, K7801M-11, K7801M-12, K7801M-13, K7801M-14, K7801M-15, K7801M-17, K7801M-19, K7801M-21, K7801M-22, K7801M-24

Juego llave BPC815 con 5 vasos, pulgadas



**BPC815K3**

		€		
1/2 in	90 x 230 x 320 mm	<b>539,49</b>	1	BPC815K3*

**BPC815**

K7801Z-1/2, K7801Z-5/8, K7801Z-3/4, K7801Z-7/8, K7801Z-15/16

Juego llave BPC815 con 5 vasos para ruedas



**BPC815K4**

		€		
1/2 in	90 x 230 x 320 mm	<b>564,76</b>	1	BPC815K4*

**BPC815**

BWSS12P5

Juego llave BPC815 con 2 vasos para ruedas



**BPC815K6**

		€		
1/2 in	90 x 230 x 320 mm	<b>497,50</b>	1	BPC815K6*

**BPC815**

BWSS12P317, BWSS12P319

Llave de impacto de 3/4"



**BP817**

	<b>BAR</b>	€		
4,500 min	6.3 bar	<b>639,58</b>	1	BP817

Diam manguera 10mm Par máx 1800Nm

Llave de impacto de composite 3/4"



**BPC817**

	<b>BAR</b>	€		
5000 min	6.2 bar	<b>720,38</b>	4	BPC817

Juego llave BPC817 con 4 vasos, mm



**BPC817K1**

		€		
3/4 in	105 x 295 x 390 mm	<b>1.068,27</b>	1	BPC817K1*

**BPC817**

K8901M-24, K8901M-27, K8901M-32, K8901M-30

\* Hasta agotar existencias



Juego llave BPC817 con 4 vasos,  
pulgadas



**BPC817K2**

		€		
3/4 in	105 x 295 x 390 mm	<b>1.049,94</b>	1	BPC817K2*

**BPC817**

K8901Z-15/16, K8901Z-1,  
K8901Z-1.1/16, K8901Z-1.1/8

Llave de Impacto de 1"



**BP901**

	<b>BAR</b>	€		
3800 min	6.2 bar	<b>1.016,60</b>	1	BP901

Diam manguera 13mm Par máx 2.800Nm

Llave de impacto de 1", Yunque largo



**BP901L**

	<b>BAR</b>	€		
3800 min	6.2 bar	<b>1.030,05</b>	1	BP901L

Diam manguera 13mm Par máx 2.800Nm

Llave de impacto 1" ligera



**BP905P**

	<b>BAR</b>	€		
6000 min	6.2 bar	<b>1.339,75</b>	2	BP905P

Llave de Impacto de 1". Eje largo.



**BP905L**

	<b>BAR</b>	€		
6000 min	6.2 bar	<b>1.345,13</b>	2	BP905L

**CARRACAS NEUMÁTICAS**

Mini Carraca de 1/4"



**BP700**

	<b>BAR</b>	€		
300 min	6.3 bar	<b>210,22</b>	20	BP700

Diam manguera 10mm

Carracas neumáticas stubby 3/8"



**BP721**

	<b>BAR</b>	€		
350 min	6.3 bar	<b>187,65</b>	1	BP721*

Carraca de 3/8"



**BP820**

	<b>BAR</b>	€		
270 min	6.3 bar	<b>224,19</b>	1	BP820*

Diam manguera 10mm

Carraca de 1/2"



**BP821**

	<b>BAR</b>	€		
150 min	6.3 bar	<b>262,94</b>	1	BP821

Diam manguera 10mm

Funda protectora para carraca neumática



**BP91B**

		€		
35 x 40 x 60 mm	12 g	3,11	1	BP91BL
30 x 30 x 45 mm	6 g	3,11	1	BP91BS

BP91BS para ser usada con BP919 y BP920 BP91L para ser usada con BP921

**AMOLADORAS, LIJADORAS Y PULIDORAS NEUMÁTICAS**

Mini Amoladora Cabeza Angular 6mm



**BP115**

	<b>BAR</b>	€		
20,000 min	6.3 bar	208,74	1	BP115

Boquillas de 3 y 6mm incluidas

Mini amoladora de bajas revoluciones



**BP117**

	<b>BAR</b>	€		
2500 min	6.3 bar	270,59	1	BP117*

Diam manguera 10mm

Amolador de bajas revoluciones para neumáticos



**BP118**

	<b>BAR</b>	€		
2500 min	6.3 bar	246,24	1	BP118*

Portamuelas con llave Conexión giratoria

Mini amoladora 6 mm



**BP822**

	<b>BAR</b>	€		
25,000 min	6.3 bar	170,45	1	BP822

Boquillas de 3 y 6mm incluidas

Amoladora 6 mm



**BP822E**

	<b>BAR</b>	€		
25000 min	6.3 bar	208,74	10	BP822E

Boquillas de 3 y 6mm incluidas

Disco abrasivo, 2 unidades



**BP421M**

		€		
53 mm	14 mm	4,70	1	BP421M*

Disco abrasivo, 2 unidades



**BP423M**

		€		
53 mm	25 mm	4,70	1	BP423M*

Disco abrasivo, 2 unidades



**BP424M**

		€		
57 mm	19 mm	4,70	1	BP424M*

\* Hasta agotar existencias



Disco abrasivo, 2 unidades



**BP430M**

		€		
55 mm	12 mm	4,70	1	BP430M*

Disco abrasivo, 2 unidades



**BP433M**

		€		
43 mm	14 mm	4,70	1	BP433M*

Amoladora Disco 5" - 125mm



**BP823**

	<b>BAR</b>	€		
10,000 min	6.3 bar	432,92	1	BP823

Diam manguera 10mm

Disco abrasivo, 2 unidades



**BP431M**

		€		
54 mm	13 mm	4,70	1	BP431M*

Disco abrasivo, 2 unidades



**BP434M**

		€		
45 mm	13 mm	4,70	1	BP434M*

Cortadora 4"/102mm de largo alcance



**BP111E**

	<b>BAR</b>	€		
15000 min	6.3 bar	318,63	12	BP111E*

Sistema bloqueo del disco

Disco abrasivo, 2 unidades



**BP432M**

		€		
44 mm	15 mm	4,70	1	BP432M*

Mini radial reversible 3" - 75 mm



**BP110**

	<b>BAR</b>	€		
18,000 min	6.3 bar	228,41	1	BP110

Diam manguera 10mm

Manguera de escape



**BP117EH**

		€		
50 x 100 x 50 mm	1 kg	46,61	1	BP117EH



Limpiadora de superficies 3.700rpm



**BP127**

	<b>BAR</b>	€		
3700 min	6.3 bar	<b>405,86</b>	1	BP127

Baja vibración

Limpiador de superficies con 19 varillas y mango tipo pistola



**BP127P**

	<b>BAR</b>	€		
3800 min	6.3 bar	<b>279,52</b>	1	BP127P*

Juego de varillas



**BP12718**

		€		
BP127, BP127P	3 mm	<b>23,21</b>	1	BP12718

Púas de acero inclinadas



**BP830CISB**

		€		
BP830K	105 mm	<b>37,80</b>	1	BP830CISB*

Juego de cepillo neumático



**BP830K**

	<b>BAR</b>	€		
4000 min	6.3 bar	<b>537,04</b>	4	BP830K*

Cepillo goma para pintura base disolvente



**BP830ESB**

		€		
30 mm	105 mm	<b>28,06</b>	1	BP830ESB*

Cepillo goma para pintura base agua



**BP830EWB**

		€		
BP830K	105 mm	<b>28,06</b>	1	BP830EWB*

Cepillo cerdas metálicas medianas inclinadas

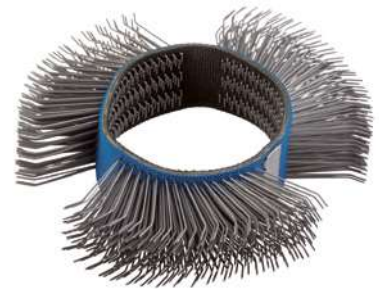

**BP830MISB**

		€		
BP830K	105 mm	<b>37,80</b>	1	BP830MISB*

Adaptador para cepillo metálico



**BP830SBA**

		€		
BP830K	105 mm	<b>24,59</b>	1	BP830SBA*

\* Hasta agotar existencias





Cepillo cerdas metálicas rectas



**BP830SSB**

		€		
BP830K	105 mm	37,80	1	BP830SSB*

Cepillo decapado



**BP830SW**

		€		
BP830K	105 mm	28,06	1	BP830SW*

Juego de lijadora mango pistola



**BP204K**

	<b>BAR</b>	€		
15000 min	6.3 bar	502,52	1	BP204K*

BP20425180, BP20410800, BP20410320, BP20425220

BP204

Almohadillas para lijadora



**BP204PAD**

		€		
77 mm	-	15,55	1	BP204PAD*

Lijadora de banda 10 mm



**BP212**

	<b>BAR</b>	€		
16,000 min	6.3 bar	251,64	1	BP212

Lijadora Orbital 5 mm composite



**BP601**

	<b>BAR</b>	€		
152 mm	6.3 bar	405,86	1	BP601

Almohadilla de Velcro® incluida

Almohadilla de velcro 53 agujeros



**BP60102**

		€		
BP601	152 mm	57,66	1	BP60102

Lijadora con mango de pistola



**BP204**

	<b>BAR</b>	€		
15000 min	6.3 bar	278,30	1	BP204*

Discos de lija



**BP204xyyy**

	€		
77 mm	35,53	1	BP20425180*

Lijadora de banda 20 mm



**BP222**

	<b>BAR</b>	€		
16,000 min	6.3 bar	<b>262,86</b>	1	BP222

Lijadora Orbital 2.5 mm



**BP610**

	<b>BAR</b>	€		
152 mm	6.3 bar	<b>405,86</b>	1	BP610

Almohadilla de Velcro® incluida

Paquete de 25 bandas para lijadora de banda



**BPN22201/21201**

	€		
10 mm	<b>146,12</b>	1	BPN21201
20 mm	<b>172,10</b>	1	BPN22201

Pulidora angular 7"



**BP809**

	<b>BAR</b>	€		
2500 min	6.3 bar	<b>418,67</b>	1	BP809*

Mango de goma

Pulidora vertical de 7"



**BP810**

	<b>BAR</b>	€		
2500 min	6.3 bar	<b>364,37</b>	1	BP810*

Almohadilla de lana 7"



**BP80950**

		€		
178 mm	15 g	<b>12,80</b>	1	BP80950

**TALADRO NEUMÁTICO**

Taladro reversible 13 mm



**BP825**

	<b>BAR</b>	€		
450 min	6.3 bar	<b>370,49</b>	1	BP825

Diam manguera 10mm Mango soporte incluido

Taladro neumático reversible de 1/2"



**BPC825**

	<b>BAR</b>	€		
800 min	6.3 bar	<b>188,93</b>	1	BPC825*

Taladro neumático reversible de 3/8"-2000rpm



**BPC823**

	<b>BAR</b>	€		
2000 min	6.3 bar	<b>161,75</b>	1	BPC823*

\* Hasta agotar existencias



Taladro neumático angular compacto de 3/8" -10 mm



**BPA823**

min <sup>-1</sup>	BAR	€		
1400 min	6.3 bar	159,18	1	BPA823*

Atornillador neumático de 1/4"



**BP826**

min <sup>-1</sup>	BAR	€		
1800 min	6.3 bar	375,71	1	BP826*

Rango par 1-10Nm

Atornillador neumático de 1/4"



**BP827**

min <sup>-1</sup>	BAR	€		
800 min	6.3 bar	417,24	1	BP827*

Rango par 1-12Nm

## HERRAMIENTAS DE CORTE

Sierra alternativa compacta con gatillo de seguridad



**BP828**

min <sup>-1</sup>	BAR	€		
10000 min	6.3 bar	284,69	1	BP828

Sierra alternativa GEAR-DRIVEN con gatillo de seguridad



**BPG824**

min <sup>-1</sup>	BAR	€		
7400 min	6.3 bar	323,52	10	BPG824*

Despegador de parabrisas



**BP233**

min <sup>-1</sup>	BAR	€		
20	6.3 bar	373,41	1	BP233

Cuchillas rectas



**BPBG**

L	€		
15 mm	35,72	1	BPBG3515*
25 mm	35,72	1	BPBG3525A*
25 mm	39,79	1	BPBG3525B*

Rascador



**BPBSC**

L	€		
15 mm	52,57	1	BPBSC156*

Cuchilla en forma de "U"



**BPBU**

L	€		
18 mm	58,44	1	BPBU18*
24 mm	58,44	1	BPBU24*
36 mm	66,57	1	BPBU36*
60 mm	71,44	1	BPBU60*
90 mm	86,85	1	BPBU90*

Cizalla neumática



**BP811**

	<b>BAR</b>	€		
2.600 min	6.3 bar	141,10	1	BP811*

Capacidad corte: 1.6mm aluminio y 1.2mm acero

Cuchilla acodada 13 mm



**BPBG5725/9057**

	€		
57 mm	35,72	1	BPBG5725*
90 mm	86,85	1	BPBG9057*

**MARTILLOS, REMACHADORAS Y MARCADORES**

Martillo neumático de 3.200 golpes por minuto



**BP910**

	<b>BAR</b>	€		
3200	6.3 bar	187,65	5	BP910

Cinzel giratorio plano 10.2 mm



**BP909TF**

	€		
170 mm	30,19	1	BP909TF*

Cinzel giratorio martillo 10.2 mm



**BP909TH**

	€		
108 mm	38,69	1	BP909TH*

Cinzel giratorio cónico 10.2 mm



**BP909TTP**

	€		
165 mm	30,19	1	BP909TTP*

Cinzel giratorio recto 10.2 mm



**BP909TSP**

	€		
165 mm	30,19	1	BP909TSP*

Cinzel giratorio canto 10.2 mm



**BP909TE**

	€		
139 mm	38,69	1	BP909TE*

Cinzel no giratorio plano 10.2 mm



**BP909NF**

	€		
190.5 mm	82,03	1	BP909NF*

\* Hasta agotar existencias



Cinzel no giratorio canto 10.2 mm



**BP909NE**

	€		
173 mm	100,61	1	BP909NE*

Remachadora neumática con 880 kg de fuerza de tracción



**BP277K**

<b>BAR</b>		€		
6.3 bar	14	285,99	8	BP277K*

Remachadora neumática con 1.600 kg de fuerza de tracción



**BP125A**

<b>BAR</b>		€		
6.3 bar	19	718,86	6	BP125A

Marcador neumático



**BP799**

	<b>BAR</b>	€		
13,000 min	6.3 bar	208,61	1	BP799

Punta del Marcador neumático BP799



**BP79912**

<b>g</b>	€		
10 g	44,02	1	BP79912

Pistola aplicadora de cartuchos



**BP215A**

<b>BAR</b>	€		
3.5-4.8 bar	67,77	10	BP215A*

## PISTOLAS DE PINTAR

Pistola para pintar HVLP



**BPHVLP01**

<b>kg</b>	<b>BAR</b>	€		
0.7 kg	2-2.8 bar	200,62	1	BPHVLP01

Juego de boquillas



**BPHVLP**

	€		
1.2 mm	23,55	1	BPHVLP0112
1.4 mm	23,55	1	BPHVLP0114
1.7 mm	23,55	1	BPHVLP0117
2.0 mm	23,55	1	BPHVLP0120

## HERRAMIENTAS DE SOPLADO Y LIMPIEZA

Pistola sopladora



**BP218**

<b>BAR</b>	€		
6.3 bar	25,99	1	BP218



Pistola de soplado



**BP219**

**BAR**

€ 1 BP219

6.3 bar 22,37

Toma de latón

Pistola de soplado con boquilla larga de 330mm



**BP219L**

**BAR**

€ 1 BP219L

6.3 bar 26,01

Toma de latón

Pistolas de soplado con entrada de latón y boquilla extralarga de 1 m



**BP219XL**

**BAR**

€ 10 BP219XL

6.3 bar 100 l/min 23,23

Pistola sopladora y aspiradora



**BP219V**

**BAR**

€ 1 BP219V\*

6.3 bar 74,06

Pistola neumática limpiadora



**BPN010**

**BAR**

€ 1 BPN010

6.2 bar 6000-7500 min 207,98

Limpia (aire & jabón) y seca

## EQUIPAMIENTO Y ACCESORIOS PARA HERRAMIENTAS NEUMATICAS

Soporte magnético para llaves de impacto



**BP500**

**kg**

€ 1 BP500\*

0.380 kg 57,10

Regulador y Filtro de 1/2"



**BP254**

**BAR**

€ 1 BP254

max 3800 L/min l/min 1-8.5 bar 146,84

Regulador, Filtro y Lubricador de 1/2"



**BP255**

**BAR**

€ 1 BP255

max 3,800 l/min 1-8.5 bar 220,24

\* Hasta agotar existencias



Unidad de filtro regulador y lubricador de 1/2" con salida de aire limpio seco de tipo T



**BP255T**

l/min	BAR	€		
max 3800 l/min	1-8.5 bar	275,64	1	BP255T*

Carrete enrollador de aire comprimido



**BPHRC815/1015**

	L	€		
8 mm	15 m	267,94	1	BPHRC815
10 mm	14+1 m	296,22	1	BPHRC1015

Adaptador opcional de control de velocidad de recogida: BPHRSC

Carrete enrollador de aire comprimido



**BPHRC1020/1316**

	L	€		
10 mm	20 m	402,61	1	BPHRC1020
13 mm	15+1 m	437,62	1	BPHRC1316

de recogida: BPHRSC

Salida de aire limpio seco adicional para unidades de filtro regulador y lubricador de 1/2"



**BP255T-1**

l/min	BAR	€		
max 3800 l/min	1-8.5 bar	44,00	1	BP255T-1

Manguera espiral de 13 mm



**BPH1310**

	L	€		
1/2"-1/2" in	10 m	88,20	1	BPH1310A

Conector neumático giratorio de 1/4"



**BPSJ**

	€		
1/4" in	31,05	1	BPSJ

Manguera espiral de 10 mm



**BPH1010**

	L	€		
1/4"-1/4" NPT in	10 m	48,69	1	BPH1010A
1/4"-1/4" BSP in	10 m	39,52	1	BPH1010B

Adaptador para enrolladores de manguera



**BPHRSC**

	€		
76 x 88 x 114 mm	97,63	1	BPHRSC

Válidos para BPHRC815 y BPHRC1015

Conectores neumáticos giratorios de 1/4" con sistema de bloqueo de la rotación



**BPSJL**

	€		
1/4" in	36,24	1	BPSJL



## Herramientas para automoción



## HERRAMIENTAS PARA MOTOR

Juego de calado para motores FCA GROUP 1.4 MULTIAIR



### BE501101

	€		
68 x 225 x 280 mm	160,87	1	BE501101

BE50110101	
BE50110102	
BE50110103	
BE50110104	

Juego de calado para FCA Group 0.9 petrol Twinair



### BE501102

	€		
68 x 225 x 280 mm	162,68	1	BE501102

BE50110201	
BE50110202	
BE50110203	

Juego de calado para FCA Group 1.6-1.9-2.0-2.4 diesel



### BE501203

	€		
68 x 225 x 280 mm	145,61	1	BE501203

BE50120301	
BE50120302	
BE50120303	
BE50120305	
BE50110103	

Polea de cigüeñal para BMW



### BE502104

		€		
60 x 98 x 269 mm	1726 g	113,31	8	BE502104*

Herramienta de sujeción del cigüeñal para BMW



### BE502106

	€		
80 x 70 x 260 mm	53,32	10	BE502106*

BE50210601	
BE50210602	
BE50210603	
BE50210605	
BE50210606	
BE50210607	

Juego de calado para FCA Group 1.3 JTD MJ



### BE501204

	€		
68 x 225 x 280 mm	220,50	1	BE501204

BE50120401	
BE50120402	
BE50120403	
BE50120404	
BE50120405	

Juego de calado para BMW 1.8-2.0 petrol

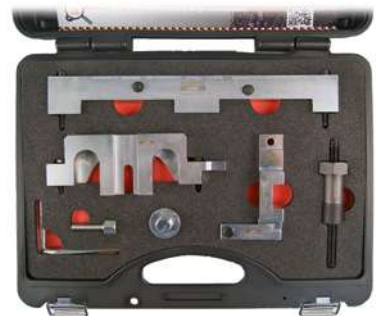

### BE502101

	€		
95 x 270 x 350 mm	482,38	1	BE502101

BE50210101	
BE50210102	
BE50210103	
BE50210104	
BE50210105	
BE50210106	
BE50210107	



Juego de calado para BMW 1.6 Petrol

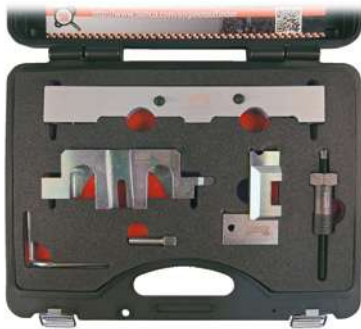

**BE502102**

	€		
270 x 95 x 355 mm	449,84	1	BE502102

BE50210103	
BE50210105	
BE50210107	
BE50210201	
BE50210202	
BE50210203	

Juego de calado para BMW 2.0 - 2.5 - 3.0 diesel



**BE502204**

	€		
68 x 225 x 280 mm	194,14	1	BE502204

BE50220401	
BE50220403	
BE50220404	
BE50220405	
BE50210305	

Juego de calado para MINI-PSA 1.4-1.6 gasolina



**BE504102**

	€		
95 x 270 x 350 mm	454,88	1	BE504102

BE50410201	
BE50410202	
BE50410203	
BE50410204	
BE50410206	
BE50210105	

Juego de calado para BMW 1.6-2.0 petrol

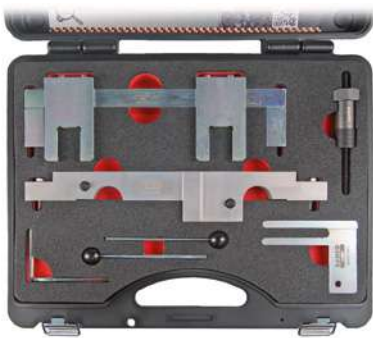

**BE502103**

	€		
80 x 300 x 375 mm	775,19	1	BE502103*

BE50210301	
BE50210302	
BE50210303	
BE50210305	
BE50210105	
BE50210107	

Juego de calado para BMW-mini 1.6-2.0 diesel



**BE503201**

	€		
68 x 225 x 280 mm	171,97	1	BE503201

BE50320101	
BE50320102	
BE50320103	
BE50320105	
BE50210305	

Juego de calado para MINI-PSA 1.6 diesel



**BE504201**

	€		
50 x 50 x 220 mm	83,21	1	BE504201

BE50420101	
BE50420102	
BE50420103	
BE50420104	
BE50210305	

\* Hasta agotar existencias





Juego de calado para Ford 1.25-1.4-1.6 gasolina



**BE505101**

	€		
68 x 225 x 280 mm	160,87	1	BE505101

BE50510101	
BE50510102	
BE50510103	
BE50510104	
BE50510105	
BE50510106	

Juego de calado para FORD 1.0 ECOBOOST gasolina



**BE505102**

	€		
95 x 270 x 350 mm	697,38	1	BE505102

BE50510201	
BE50510202	
BE50510203	
BE50510204	
BE50420102	
BE50510102	

Juego de calado para FORD 2.0 - 2.2 - 2.4 Duratorq TDCI 16v diesel



**BE505203**

	€		
95 x 270 x 350 mm	249,63	1	BE505203

BE50520301	
BE50520302	
BE50520303	
BE50520304	
BE50520305	
BE50520306	
BE50520307	

Juego de calado para Ford 1.4-1.6-1.8-2.0-2.2-2.5 diesel



**BE505204**

	€		
95 x 270 x 350 mm	238,53	1	BE505204

BE50520401	
BE50520402	
BE50520403	
BE50520404	
BE50520405	
BE50520407	
BE50520411	
BE50520412	
BE50520413	
BE50510104	
BE50420102	
BE50420103	
BE50420104	
BE50510106	

Juego de calado para Opel 1.0-1.2-1.4 gasolina



**BE506101**

	€		
50 x 50 x 160 mm	216,42	1	BE506101

BE50610101	
BE50610102	
BE50610103	
BE50610104	
BE50610105	

Juego de calado para Opel 1.4-1.6-1.8 gasolina



**BE506102**

	€		
68 x 225 x 280 mm	190,96	1	BE506102

BE50610201	
BE50610202	
BE50610203	
BE50610204	
BE50610205	
BE50610206	

Juego de calado para Opel 1.0-1.2-1.4 Ecoflex gasolina



**BE506103**

95 x 270 x 350 mm € 510,65 1 BE506103

- BE50610302
- BE50610304
- BE50610102
- BE50610103
- BE50610105

Juego de calado para Opel 2.0 diesel



**BE506204**

85 x 300 x 375 mm € 297,06 1 BE506204

- BE50620401
- BE50620402
- BE50620403
- BE50620404
- BE50620405

Juego de calado para PSA 1.0-1.1-1.4-1.6-1.8-2.0-2.2 gasolina



**BE507101**

95 x 270 x 350 mm € 396,09 1 BE507101

- BE50710103
- BE50710104
- BE50710105
- BE50710106
- BE50710107
- BE50710108
- BE50710109
- BE50710110
- BE50710111
- BE50710112
- BE50710101
- BE50710102
- BE50710113
- BE50710114
- BE50710116
- BE50710117
- BE50710118
- BE50710119
- BE50420104

Juego de calado para PSA 1.0-1.2 gasolina



**BE507102**

68 x 225 x 280 mm € 422,95 1 BE507102

BE50710201

BE50710202

Juego de calado para PSA 1.4-1.5-1.6-1.9-2.0-2.2-2.5 diesel



**BE507203**

85 x 300 x 375 mm € 416,05 1 BE507203

- BE50720301
- BE50720302
- BE50720304
- BE50720305
- BE50720307
- BE50720308
- BE50720310
- BE50720312
- BE50720314
- BE50720317
- BE50720318
- BE50720319
- BE50720320
- BE50720321
- BE50720322
- BE50720323
- BE50520404
- BE50520411
- BE50710107
- BE50710104
- BE50710113
- BE50710110
- BE50710102
- BE50710106
- BE50420102
- BE50420103



Juego de calado para Renault/Dacia 1.2-1.4-1.6-1.8-2.0 gasolina

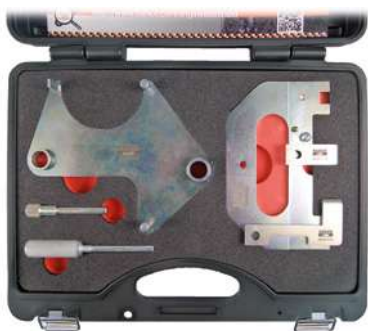

**BE508101**

95 x 270 x 350 mm € 241,32 1 BE508101

BE50810101	
BE50810102	
BE50810103	
BE50810104	
BE50810105	
BE50810106	

Juego de calado para Renault 1.5-1.9-2.2-2.5 diesel



**BE508202**

80 x 300 x 375 mm € 324,52 1 BE508202

BE50820201	
BE50820202	
BE50820203	
BE50820204	
BE50820205	
BE50820206	
BE50820207	
BE50820208	
BE50820209	
BE50820211	
BE50810103	
BE50810104	

Juego de calado para Renault 2.0 diesel



**BE508203**

68 x 225 x 280 mm € 305,54 1 BE508203

BE50820301	
BE50820302	
BE50820303	
BE50820304	
BE50210305	

Juego de calado para Renault -Nissan 1.6 diesel



**BE508204**

95 x 270 x 350 mm € 434,28 1 BE508204

BE50820402	
BE50820403	
BE50820404	
BE50820302	

Juego de calado para VW Group 1.4-1.6-1.8-2.0 gasolina



**BE509101**

80 x 300 x 375 mm € 282,92 1 BE509101

BE50910101	
BE50910102	
BE50910103	
BE50910104	
BE50910105	
BE50910106	
BE50910107	
BE50910108	
BE50910109	
BE50910110	
BE50910111	
BE50910112	
BE50910114	
BE50520302	

Juego de calado para VW Group 1.2-1.4-1.6 gasolina



**BE509102**

68 x 225 x 280 mm € 472,47 1 BE509102

BE50910201	
BE50910202	
BE50910203	
BE50910205	
BE50910206	
BE50910207	
BE50520302	



Juego de calado para VW Group 1.2 TSI gasolina



**BE509103**

50 x 50 x 210 mm € 81,83 1 BE509103

BE50910302

BE50910203

Juego de calado para VW Group 1.0 gasolina



**BE509104**

68 x 225 x 280 mm € 493,69 1 BE509104

BE50910401

BE50910402

BE50910403

BE50910404

BE50910203

Juego de calado para VW Group 1.2-1.4-1.6-1.9-2.0 diesel



**BE509205\_1**

60 x 60 x 220 mm € 72,12 1 BE509205

BE50910103

BE50920602

BE50920603

Juego de calado para VW Group 1.9-2.0 diesel



**BE509206**

60 x 60 x 220 mm € 73,52 1 BE509206

BE50920602

BE50910103

BE50920703

Juego de calado para VW Group 1.2-1.4-1.6-1.9-2.0 diesel



**BE509207**

95 x 270 x 350 mm € 291,24 1 BE509207

BE50920703

BE50920707

BE50920708

BE50920709

BE50920710

BE50920711

BE50910103

BE50910112

BE50920602

BE50920603

BE50910109

BE50510102

Juego de calado para VOLVO 1.6 - 1.8 - 1.9 - 2.0 - 2.3 - 2.4 - 2.5 gasolina



**BE510101**

60 x 60 x 355 mm € 247,55 1 BE510101

BE51010101

BE51010102

BE51010103

Juego de calado para VOLVO 1.6 - 1.8 - 2.0 16v. gasolina



**BE510102**

50 x 50 x 220 mm € 55,21 1 BE510102

BE51010201

BE51010202

BE50510102

BE50510105

BE50510106



Juego de calado para VOLVO 1.6 - 2.0 diesel



**BE510203**

68 x 225 x 280 mm € 192,38 1 BE510203

- BE50420102
- BE50420103
- BE50420104
- BE50520407
- BE50520411
- BE50510104

Herramienta de sujeción de la polea del cigüeñal para Volvo



**BE510304**

50 x 145 x 265 mm € 120,24 1 BE510304

Juego de calado para SAAB 1.8i gasolina



**BE511101**

50 x 50 x 220 mm € 82,04 1 BE511101

- BE51110101
- BE51110102
- BE50610201
- BE50610204

Juego de calado para SAAB 1.6t gasolina



**BE511102**

50 x 50 x 207 mm € 65,07 1 BE511102

- BE50610201
- BE50610202
- BE50610205
- BE50610203

Juego de calado para SAAB 1.9 - 2.0 - 2.2 Tid diesel



**BE511203**

80 x 300 x 375 mm € 346,71 1 BE511203

- BE51120301
- BE51120302
- BE51120303
- BE51120304
- BE51120305
- BE50120302
- BE50120303
- BE50120305
- BE50610201

Juego Extracción Bujías M8-M9-M10



**BE513201**

95 x 270 x 350 mm 2.10 kg € 547,81 1 BE513201

- BE51320101
- BE51320102
- BE51320103
- BE51320104
- BE51320105
- BE51320106
- BE51320107
- BE51320108
- BE51320109
- BE51320110
- BE51320111
- BE51320112
- BE51320113
- BE51320114

Mango amarre de poleas universal



**BE523106**

410 mm € 63,87 1 BE523106



Juego universal de bloqueo de árbol de levas



**BE5100**

	€		
345 x 150 x 85 mm	98,54	1	BE5100

Util de cambios de correa sin tensor



**BE230**

	€		
35 x 145 x 155 mm	184,37	1	BE230

Juego extractor polea alternador



**BE500P24**

	€		
55 x 270 x 370 mm	152,55	5	BE500P24
	11,91	1	BE500P2401
	11,60	1	BE500P2402
	12,90	1	BE500P2403
	13,06	1	BE500P2404
	13,92	1	BE500P2405
	17,96	1	BE500P2406
	17,96	1	BE500P2407
	6,73	1	BE500P2408

	€		
	6,66	1	BE500P2409
	6,66	1	BE500P2410
	6,66	1	BE500P2411
	6,66	1	BE500P2412
	6,66	1	BE500P2413
	18,13	1	BE500P2414
	12,32	1	BE500P2415
	11,65	1	BE500P2416
	11,45	1	BE500P2417
	11,91	1	BE500P2418
	11,45	1	BE500P2419
	11,91	1	BE500P2420
	11,91	1	BE500P2421
	17,96	1	BE500P2422
	11,60	1	BE500P2423
	11,60	1	BE500P2424

Compresímetro para motores diesel



**BE5401D**

	€		
105 x 325 x 410 mm	678,17	1	BE5401D

Bar 0-69 PSI 0-1000

Compresímetro para motores de gasolina



**BE5400P**

	€		
70 x 160 x 260 mm	187,23	1	BE5400P

Tensímetro de correas



**BE239**

		€		
38 x 82 x 95 mm	95 mm	97,08	1	BE239

Grosor de correa 2-8mm

Tensiómetro digital de correas



**BE240**

		€		
60 x 270 x 315 mm	315 mm	1.022,52	1	BE240

Unidad de medida; Herzios

Libro de datos de valores de tensión para la sincronización y correas accesorias, sincrónica, V & V y forma acanalada.



**BE240-CAT**

	€		
710 g	110,95	1	BE240-CAT



Termómetro infrarrojos



**BLT550**

		€		
-50 +550 °C	40 x 95 x 145 mm	77,66	10	BLT550

Campo: 12:1 Precisión: ±1.5% o ±1.5 °C

Juego para línea de combustible 7 piezas



**BE257**

	€		
68 x 225 x 280 mm	106,46	8	BE257
	17,62	1	BE25710
	17,62	1	BE25718
	12,49	1	BE2572
	15,49	1	BE2576

Kit universal de extracción de inyectores



**BE512201**

	€		
140 x 415 x 600 mm	2.246,70	1	BE512201

BE51220101	
BE51220102	
BE51220103	
BE51220104	
BE51220105	
BE51220106	
BE51220107	
BE51220108	
BE51220109	
BE51220110	
BE51220111	
BE51220112	
BE51220113	
BE51220114	
BE51220115	
BE51220116	
BE51220117	
BE51220118	
BE51220119	
BE51220120	

Juego de extractores de inyectores



**BE1311P13**

	€		
80 x 355 x 445 mm	435,47	1	BE1311P13

Juego de vasos para inyectores diesel, 25-27-29-30 mm



**BE1310P4**

	€		
68 x 225 x 225 mm	117,89	1	BE1310P4*

Vaso impacto 1/2" para extraer inyectores diesel



**BE1310P425-BE1310P430**

		€		
25 mm	1/2 in	28,31	1	BE1310P425
27 mm	1/2 in	30,99	1	BE1310P427
29 mm	1/2 in	33,44	1	BE1310P429
30 mm	1/2 in	33,44	1	BE1310P430

Motores Bosch, Siemens, PSA HDI (2.0)

Juego para limpieza de asientos de inyectores diesel



**BE1320S17**

	€		
76 x 266 x 355 mm	122,19	10	BE1320S17

Un adaptador de 1/4"

Juego para rectificar asientos de inyectores



**BE1315P7**

	€		
68 x 225 x 280 mm	124,67	1	BE1315P7
25 x 180 x 275 mm	24,15	1	BE1315P71
20 x 93 x 175 mm	20,26	1	BE1315P72
19 x 93 x 140 mm	25,09	1	BE1315P73
16 x 93 x 140 mm	24,52	1	BE1315P74
20 x 56 x 96 mm	24,52	1	BE1315P75
20 x 56 x 96 mm	25,09	1	BE1315P76
23 x 56 x 96 mm	27,69	1	BE1315P77

Martillo deslizante



**BE1300SH**

	€		
235 mm	51,31	10	BE1300SH

Extractor de asiento de válvula para inyectores DENSO



**BE1312DNS**

	€		
	11,78	12	BE1312DNS*

Extractor de arandelas de cobre de inyectores



**BE1300**

	€		
230 mm	98,47	1	BE1300

Set Válvula Lapper



**BE762**

	g	€		
30 x 90 x 315 mm	68 g	13,27	12	BE762

Alicate desmontador de válvulas



**BE76101**

	€		
40 x 200 x 290 mm	64,36	1	BE76101

Juego de arandelas de cobre para inyectores



**BE1305P450**

	€		
40 x 140 x 205 mm	343,93	1	BE1305P450*

Set de 30 arandelas de cobre para inyectores

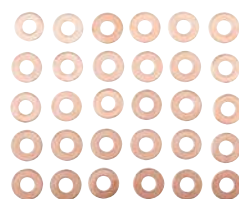

**BE1305P450B**

	€		
	25,29	1	BE1305P450WS01
	13,64	1	BE1305P450WS02
	21,55	1	BE1305P450WS03
	25,80	1	BE1305P450WS04
	29,49	1	BE1305P450WS05
	33,73	1	BE1305P450WS06
	20,94	1	BE1305P450WS07
	22,18	1	BE1305P450WS08
	27,04	1	BE1305P450WS09
	29,49	1	BE1305P450WS10
	30,03	1	BE1305P450WS11
	17,93	1	BE1305P450WS12
	13,64	1	BE1305P450WS13
	13,64	1	BE1305P450WS14
	30,03	1	BE1305P450WS15

Comprobador de retorno de inyección en motores common rail



**BE5350**

	€		
84 x 341 x 447 mm	270,45	5	BE5350*
10 x 56 x 96 mm	41,20	1	BE5350C1
10 x 56 x 96 mm	41,20	1	BE5350C2
10 x 56 x 96 mm	41,20	1	BE5350C3
10 x 56 x 96 mm	21,30	1	BE5350C4
115 x 65 x 205 mm	173,86	1	BE5350C5

\* Hasta agotar existencias



Bomba para tarar inyectores y circuitos diesel



**BE13ZL11**

		€		
480 x 230 x 280 mm	4.24 kg	624,08	1	BE13ZL11

Vasos 1/4" Torx® Plus Inviolables



**BE5008-10/BE5008-45**

	€		
10	16,22	1	BE5008-10*
15	16,22	1	BE5008-15*
20	16,22	1	BE5008-20*
25	16,22	1	BE5008-25*
27	16,22	1	BE5008-27*
30	16,22	1	BE5008-30*
40	16,22	1	BE5008-40*
45	16,22	1	BE5008-45*

Set de 5 insertos M8x1



**BE1210P110x**

		€		
M8x1	50 g	12,96	1	BE1210P1101
M10x1	50 g	13,98	1	BE1210P1102
M10x1,25	50 g	13,98	1	BE1210P1103

Vasos especiales para inyección Diesel



**7807**

		€		
29 mm	80 mm	12,36	1	7807*

Juego de 5 vasos articulados para calentadores bi-hex universal



**BE1GP5**

		€		
1/4 in	110 x 240 x 40 mm	66,96	1	BE1GP5

Juego de limpieza de alojamiento de calentadores



**BE1200P6**

	€		
50 x 115 x 260 mm	157,30	1	BE1200P6

Juego de 8 vasos con punta Torx® Plus inviolables



**BE5008**

	€		
40 x 20 x 175 mm	105,28	1	BE5008*

TR+10,15,20,25,27,30,40,45

BE5008-45, BE5008-27, BE5008-25, BE5008-40, BE5008-30, BE5008-10, BE5008-20, BE5008-15

Extractor de calentadores



**BE1205**

		€		
130 mm	35 x 35 x 130 mm	83,21	1	BE1205

Válido para calentadores de 9 y 10mm

Juego de limpieza de alojamiento de calentadores



**BE1200P6AC1**

	€		
50 x 158 x 192 mm	111,82	1	BE1200P6AC1



Mango en T para calentadores



**BE1GP5-T**

		€		
1/4 in	400 mm	30,05	10	BE1GP5-T

Herramientas para bujías, calentadores e inyectores



**BE1GP58/BE1GP514**

		€		
8 mm	70 mm	23,20	1	BE1GP58
9 mm	70 mm	23,20	1	BE1GP59
10 mm	70 mm	23,20	1	BE1GP510
12 mm	70 mm	23,20	1	BE1GP512
14 mm	70 mm	23,20	1	BE1GP514

Juego de reparación de roscado de calentadores



**BE1210P11**

	€		
50 x 120 x 260 mm	162,27	1	BE1210P11
112 x 13 x 95 mm	110,98	1	BE1210P9AC1

Insertos BE1210P9AC1

Alicates para bujías



**BE1P**

		€		
290 mm	20 x 50 x 290 mm	78,33	1	BE1P

Adaptador flexible para bujías



**BE1SP1F**

		€		
30 mm	21 x 330 x 330 mm	29,38	12	BE1SP1F*

Vasos para bujías, cuadrado 3/8", magnético



**7406ZZ**

		€		
16 mm	65 mm	32,93	1	7406ZZ-16
21 mm	64 mm	32,93	1	7406ZZ-21

Vasos para bujías 1/2"



**7805GPR**

		€		
16 mm	64 mm	5,02	120	7805GPR-16
21 mm	64 mm	5,46	100	7805GPR-21

Vasos para bujías 3/8"



**7402GPR**

	€		
16 mm	3,03	120	7402GPR-16
18 mm	5,20	120	7402GPR-18
21 mm	3,56	100	7402GPR-21

Llave para bujías



**BE1SP**

		€		
3/8 in	252 mm	27,60	10	BE1SP16L
3/8 in	252 mm	27,60	1	BE1SP14L

\* Hasta agotar existencias





Claves para bujías, articulación cardan



### BE1T14/BE1T16/BE1T21

		€		
14 mm	65/310 mm	35,78	1	BE1T14
16 mm	63/450 mm	40,91	1	BE1T16
21 mm	67/450 mm	40,31	1	BE1T21

Juego de 9 vasos de 1/2 con punta RIBE, adecuado para motores



### BE5102

	€		
65 x 225 x 225 mm	98,84	1	BE5102

BE51026, BE51025, BE510210,  
BE510211, BE510212, BE510213,  
BE51027, BE51028, BE51029

Juego de 6 vasos de 1/2 con punta XZN, adecuado para motores



### BE5103

	€		
65 x 225 x 225 mm	88,19	1	BE5103

BE51036, BE51038, BE510310,  
BE510312, BE51035, BE510314

Kit de reparación de roscas para bujías



### BE110014/BE110015

	€		
55 g	21,55	1	BE110014
55 g	105,35	1	BE110015

Kit de reparación de roscas para bujías



### BE1100AC1/BE1100AC2

	€		
9.4 mm	70,16	1	BE1100AC1
15 mm	21,85	1	BE1100AC2

Vaso de 1/2" con punta RIBE



### BE51025-BE510213

		€		
RM5	100 mm	8,11	1	BE51025
RM6	100 mm	8,11	1	BE51026
RM7	100 mm	8,11	1	BE51027
RM8	100 mm	8,50	1	BE51028
RM9	100 mm	8,50	1	BE51029
RM10	100 mm	8,50	1	BE510210
RM11	100 mm	9,92	1	BE510211
RM12	100 mm	10,31	1	BE510212
RM13	100 mm	12,74	1	BE510213

Vasos de 1/2" con punta XZN



### BE51035-BE510314

		€		
M5	140 mm	8,46	1	BE51035
M6	140 mm	8,46	1	BE51036
M8	140 mm	8,46	1	BE51038
M10	140 mm	8,46	1	BE510310
M12	140 mm	10,24	1	BE510312
M14	140 mm	14,03	1	BE510314

Cepillo para limpiar bujías



### 52

	€		
150 mm	4,46	12	52

Cepillo multi-uso



**782-U**

	€		
285 mm	6,89	1	782-U

Kit de reparación de roscas para bujías



**BE110001**

	€		
60 g	62,76	1	BE110001

Refractómetro



**3046-REF**

	€		
150 mm	137,31	1	3046-REF

Cepillo para terminales



**2555**

	€		
85 mm	8,44	1	2555

Tenaza para segmentos



**BE74-55100/BE74-80120**

		€		
55-100 mm	20 x 130 x 205 mm	48,60	1	BE74-55100
80-120 mm	20 x 145 x 220 mm	51,52	1	BE74-80120

Comprobador anticongelante



**BE401**

		€		
50 x 50 x 235 mm	235 mm	11,01	1	BE401

Kit de reparación de roscas de bujías



**BE1100**

		€		
68 x 225 x 280 mm	1.55 kg	334,55	8	BE1100

Ceñidor de segmentos de pistón



**BE74-57125/BE74-90175**

		€		
80 mm	57-125 mm	50,04	1	BE74-57125
165 mm	90-175 mm	75,05	1	BE74-90175
80 mm	57-125 mm	54,48	1	BE74-57125L

Juego para el control del circuito de refrigeración



**BE400P24**

	€		
127 x 435 x 510 mm	436,85	1	BE400P24



Comprobador de bombas de tensión con galgas



**BE400P241**

<b>BAR</b>	<b>PSI</b>	€		
0-2,5 bar	0-36 psi	117,38	1	BE400P241

Termómetro



**BE400P244**

	€		
0.02 kg	23,11	1	BE400P244

Adaptador Metálico



**BE400P2403**

	€		
43.5 mm	25,42	1	BE400P2403

Conector R123/R124 Negro



**BE400P242**

	€		
0.035 kg	11,94	1	BE400P242

Adaptador Metálico



**BE400P2401**

	€		
65 mm	28,74	1	BE400P2401

Adaptador



**BE400P2404**

	€		
0.055 kg	16,56	1	BE400P2404

Conector R123/R125 Azul



**BE400P243**

	€		
0.06 kg	11,94	1	BE400P243

Adaptador Metálico



**BE400P2402**

	€		
65 mm	28,74	1	BE400P2402

Adaptador



**BE400P2405**

	€		
0.065 kg	16,56	1	BE400P2405

Adaptador



**BE400P2406**

	€		
0.065 kg	16,56	1	BE400P2406

Adaptador



**BE400P2409**

	€		
0.11 kg	16,56	1	BE400P2409

Adaptador



**BE400P2412**

	€		
0.085 kg	16,56	1	BE400P2412

Adaptador



**BE400P2407**

	€		
0.065 kg	16,56	1	BE400P2407

Adaptador



**BE400P2410**

	€		
0.085 kg	16,56	1	BE400P2410

Adaptador



**BE400P2413**

	€		
0.065 kg	16,56	1	BE400P2413

Adaptador



**BE400P2408**

	€		
0.075 kg	16,56	1	BE400P2408

Adaptador



**BE400P2411**

	€		
0.11 kg	16,56	1	BE400P2411

Adaptador



**BE400P2414**

	€		
0.11 kg	17,50	1	BE400P2414



Adaptador para comprobar sistema de refrigeración



**BE400P2415**

	€		
0,075 kg	17,81	1	BE400P2415

Adaptador



**BE400P2418**

	€		
0,045 kg	17,50	1	BE400P2418

Equipo para purga y relleno del líquido de refrigeración



**BE410**

	€		
80 x 300 x 375 mm	271,82	4	BE410
45 x 45 x 105 mm	11,93	1	BE4101

Adaptador



**BE400P2416**

	€		
0,065 kg	17,50	1	BE400P2416

Adaptador



**BE400P2419**

	€		
0,075 kg	17,50	1	BE400P2419

Juego para el reemplazo de juntas



**BE700**

	€		
90 x 200 x 43 mm	88,13	1	BE700*
	81,23	1	BE700BP2
	38,31	1	BE700SP15

Adaptador



**BE400P2417**

	€		
0,11 kg	17,50	1	BE400P2417

Llave de plástico para radiador



**BE400P2420**

	€		
0,005 kg	44,18	1	BE400P2420

Juego de puntas de 10mm



**BE5032**

	€		
65 x 225 x 225 mm	93,68	1	BE5032



BE5049M5, BE5049M6, BE5049M8, BE5049M10, BE5049M12, BE5032M14	
BE5049T20, BE5049T25, BE5049T27, BE5049T30, BE5049T40, BE5049T45, BE5049T50, BE5049T55, BE5049T60	
BE5049H5, BE5049H6, BE5049H8, BE5049H10, BE5049H12, BE5032H14	
BE5032SQ8, BE5032SQ10	
BE5049H6L, BE5049H8L, BE- 5032H10EL	
BE5049T45L, BE5032T55EL	
BE5049M8L, BE5049M10L, BE5049M12L	
BE504901	

Caja 5 Puntas Robertson de 10 mm



### BE5032SQ

#	L	€	Icon	Icon
#8 mm	30 mm	25,51	1	BE5032SQ8
#10 mm	30 mm	30,84	1	BE5032SQ10

Vasos de 1/2" con punta TORX®  
inviolables



### BE510125-BE510160

#	L	€	Icon	Icon
TR25	100 mm	7,29	1	BE510125
TR27	100 mm	7,29	1	BE510127
TR30	100 mm	7,29	1	BE510130
TR40	100 mm	7,29	1	BE510140
TR45	100 mm	7,65	1	BE510145
TR50	100 mm	7,65	1	BE510150
TR55	100 mm	7,65	1	BE510155
TR60	100 mm	9,16	1	BE510160

Juego para retenes de cigüeñal y árbol  
de levas



### BE5150P27

#	€	Icon	Icon
80 x 270 x 375 mm	382,03	1	BE5150P27
56 x 56 x 96 mm	126,75	1	BE5150P271
80 x 80 x 195 mm	35,40	1	BE5150P272
170 x 160 x 385 mm	231,15	1	BE5150P273

Juego de herramientas para reparación de  
A/A 12 pzas



### BE800P12

#	€	Icon	Icon
43 x 90 x 200 mm	74,90	1	BE800P12

Juego para soltar conectores rápidos



### BAC007

#	kg	€	Icon	Icon
240 mm	0,075 kg	12,48	1	BAC007

Medidas: 1/4", 5/16", 3/8", 1/2", 5/8", 3/4", 7/8"

Barra soporte para motores



### BH8AC1-500

#	kg	€	Icon	Icon
150 x 165 x 1800 mm	20,71 kg	164,91	1	BH8AC1-500

Soporte para motores 500kg



### BH8AC2-500

#	kg	€	Icon	Icon
500 kg		486,41	1	BH8AC2-500

Alicata para abrazaderas 45°



### BE250

#	g	€	Icon	Icon
190 mm	245 g	48,54	1	BE250



Alicates con Puntas Giratorias



**BE251A**

		€		
30 x 55 x 220 mm	228 g	48,54	12	BE251A

Kit de reparación para BE254A



**BE254A-01**

		€		
590 mm	130 g	42,28	1	BE254A-01

Estrangulador de latiguillos



**BE256M**

	€		
40 x 45 x 310 mm	47,13	1	BE256M

Alicate de sirga para abrazaderas EGR



**BE253**

	€		
870 mm	123,44	1	BE253

Kit reparación para alicate BE254



**BE2541**

	€		
100 g	17,08	1	BE2541

Alicate para abrazaderas elásticas



**BE258**

		€		
12-55 mm	285 mm	128,36	1	BE258

Alicates con sirga para abrazaderas



**BE254A**

	€		
18-53 mm	116,32	1	BE254A

Cable para alicates BE253, BE254 y BE255

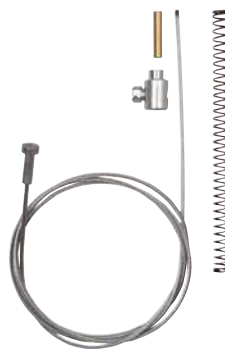

**BE2542**

		€		
630 mm	20 g	6,52	1	BE2542

Alicate para abrazaderas OETIKER™



**BPOC15**

	€		
275 mm	81,85	12	BPOC15

Juego de 3 alicates para latiguillos



**BE256P3**

Icon	€	Icon	Icon
40 x 93 x 330 mm	34,68	1	BE256P3
15 x 55 x 155 mm	9,71	1	BE256-155
20 x 45 x 185 mm	12,48	1	BE256-178
10 x 55 x 250 mm	16,63	1	BE256-250

Alicates para líneas de combustible



**BE6FCP**

Icon	L	€	Icon	Icon
104 mm	218 mm	45,74	30	BE6FCP

Extractor universal de aforador de combustible



**BE1FTW**

Icon	€	Icon	Icon
75-160 mm	69,90	1	BE1FTW

Juego de 6 vasos acanalados



**BE5500**

Icon	€	Icon	Icon
10/11/12/14/17/19	54,65	25	BE5500

Juego de alicates para desconexión de conductos de combustible de 8 y 10mm



**BE1FLDS**

Icon	€	Icon	Icon
8-10 mm	45,77	1	BE1FLDS

BE1FLD2, BE1FLD3, BE1FLD1

Llave de filtro de combustible para Ford 2.2TDCi



**BE1FFWF**

Icon	€	Icon	Icon
5 x 142 x 169 mm	24,27	12	BE1FFWF

Juego de vasos acanalados



**BE5500-10/BE-5500-19**

Icon	Icon	€	Icon	Icon
3/8 in	10	10,14	1	BE550010
3/8 in	11	10,14	1	BE550011
3/8 in	12	10,14	1	BE550012
3/8 in	14	10,14	1	BE550014
1/2 in	17	10,60	1	BE550017
1/2 in	19	10,93	1	BE550019

Alicates desconexión de combustible



**BE1FLD1/BE1FLD3**

Icon	€	Icon	Icon
10 mm	16,79	1	BE1FLD1
8 mm	16,79	1	BE1FLD2
18.5 mm	16,79	1	BE1FLD3

Juego de 6 leznas



**2633HD/S6**

Icon	€	Icon	Icon
80 x 270 x 375 mm	136,84	1	2633HD/S6
42 x 93 x 290 mm	44,41	1	2633HD1
30 x 85 x 215 mm	19,64	1	2633HD2
30 x 93 x 200 mm	17,04	1	2633HD3
20 x 87 x 165 mm	13,15	1	2633HD4
10 x 60 x 120 mm	12,40	1	2633HD5
10 x 10 x 155 mm	7,16	1	2633HD6



Juego de 5 llaves en T de 4-5-6-8 y 10 mm



**BE1TH-S5**

mm	g	€	Paquete	Icono	Modelo
5	60	22,19	10	BE1TH-S5	BE1TH-S5

Juego de 6 llaves en T con puntas hexagonales, 2,5-3-4-5-6-8mm



**BE1TH-S6**

mm	g	€	Paquete	Icono	Modelo
6	102,63	30	30	BE1TH-S6	BE1TH-S6

BE1TH-2.5, BE1TH-3, BE1TH-4, BE1TH-8, BE1TH-6, BE1TH-5

Llaves en T con puntas hexagonales



**BE1TH**

mm	g	€	Paquete	Icono	Modelo
10 mm	385 g	30,85	5	BE1TH-10	
2 mm	15 g	17,75	10	BE1TH-2	
2.5 mm	20 g	17,75	10	BE1TH-2.5	
3 mm	23 g	18,23	10	BE1TH-3	
3.5 mm	23 g	18,23	10	BE1TH-3.5*	
4 mm	60 g	20,73	10	BE1TH-4	
4.5 mm	60 g	21,49	10	BE1TH-4.5*	

mm	g	€	Paquete	Icono	Modelo
5 mm	60 g	22,19	10	BE1TH-5	
6 mm	127 g	24,56	10	BE1TH-6	
7 mm	205 g	28,24	10	BE1TH-7*	
8 mm	205 g	28,24	10	BE1TH-8	
9 mm	385 g	30,85	10	BE1TH-9*	

Juego de 7 llaves en T con vaso giratorio, 7-8-10-12-13-14-17mm



**BE1TS-S7**

mm	g	€	Paquete	Icono	Modelo
7	193,58	1	1	BE1TS-S7	BE1TS-S7

BE1TS-17, BE1TS-13, BE1TS-14, BE1TS-12, BE1TS-7, BE1TS-8, BE1TS-10

Llaves en T con vaso giratorio



**BE1TS**

mm	g	€	Paquete	Icono	Modelo
10 mm	485 g	30,51	10	BE1TS-10	
11 mm	485 g	30,78	10	BE1TS-11*	
12 mm	475 g	31,61	10	BE1TS-12	
13 mm	485 g	32,31	10	BE1TS-13	
14 mm	485 g	32,31	10	BE1TS-14	
15 mm	485 g	35,02	10	BE1TS-15*	
16 mm	495 g	35,02	10	BE1TS-16*	
17 mm	495 g	35,02	10	BE1TS-17	
18 mm	510 g	38,27	10	BE1TS-18*	
19 mm	495 g	38,27	10	BE1TS-19*	
20 mm	730 g	45,22	8	BE1TS-20*	
21 mm	765 g	25,30	8	BE1TS-21*	
22 mm	745 g	45,35	8	BE1TS-22*	
24 mm	745 g	41,47	8	BE1TS-24*	
6 mm	475 g	26,64	10	BE1TS-6	
7 mm	475 g	26,64	10	BE1TS-7	
8 mm	485 g	29,27	10	BE1TS-8	
9 mm	475 g	30,51	10	BE1TS-9*	

Llave en T, 1/2"



**1945W**

mm	L	€	Paquete	Icono	Modelo
1/2 in	311 mm	58,10	6	1945W12	
1/4 in	311 mm	37,99	8	1945W14	
3/8 in	311 mm	45,80	6	1945W38	

Juego de Puntas 10mm



**BE5049**

mm	kg	€	Paquete	Icono	Modelo
55 x 190 x 320 mm	3.56 kg	117,89	5	BE5049	BE5049

Adaptador 1/2" para puntas 10 mm



**BE504901**

mm	L	€	Paquete	Icono	Modelo
10 mm	36 mm	12,72	1	BE504901	BE504901



Caja 5 Puntas hexagonales, 10mm



**BE5049H**

			€		
4 mm	30 mm	15,37	1	BE5049H4	
5 mm	30 mm	15,37	1	BE5049H5	
6 mm	30 mm	15,37	1	BE5049H6	
7 mm	30 mm	15,37	1	BE5049H7	
8 mm	30 mm	15,37	1	BE5049H8	
10 mm	30 mm	15,37	1	BE5049H10	
12 mm	30 mm	19,13	1	BE5049H12	
14 mm	30 mm	32,39	1	BE5032H14	

Caja 5 Puntas XZN, 10mm



**BE5049M**

			€		
M5	30 mm	15,37	1	BE5049M5	
M6	30 mm	15,37	1	BE5049M6	
M8	30 mm	15,37	1	BE5049M8	
M10	30 mm	15,37	1	BE5049M10	
M12	30 mm	19,13	1	BE5049M12	
M14	30 mm	36,45	1	BE5032M14	

Caja 5 puntas TORX®, 10 mm



**BE5049T**

			€		
T20	30 mm	14,85	1	BE5049T20	
T25	30 mm	14,85	1	BE5049T25	
T27	30 mm	14,85	1	BE5049T27	
T30	30 mm	14,85	1	BE5049T30	
T40	30 mm	14,85	1	BE5049T40	

			€		
T45	30 mm	14,85	1	BE5049T45	
T50	30 mm	14,85	1	BE5049T50	
T55	30 mm	14,85	1	BE5049T55	
T60	30 mm	21,75	1	BE5049T60	

Caja 5 Puntas Torx® inviolable, 10mm



**BE5049T\_H**

			€		
TR20	30 mm	15,37	1	BE5049T20H	
TR25	30 mm	15,37	1	BE5049T25H	
TR27	30 mm	15,37	1	BE5049T27H	
TR30	30 mm	15,37	1	BE5049T30H	
TR40	30 mm	15,37	1	BE5049T40H	
TR45	30 mm	15,37	1	BE5049T45H	
TR50	30 mm	15,37	1	BE5049T50H	
TR55	30 mm	15,37	1	BE5049T55H	
TR60	30 mm	22,25	1	BE5049T60H	

Juego de 9 vasos de 1/2 con punta TORX®, inviolables



**BE5101**

		€		
65 x 225 x 225 mm	98,84	1	BE5101	

BE510150, BE510145, BE510160,  
BE510155, BE510127, BE510125,  
BE510140, BE510130

Comprobador de presión de aceite motor



**BE5200**

		€		
85 x 355 x 445 mm	206,65	1	BE5200	
25 x 105 x 195 mm	172,28	1	BE530001	
	23,53	1	BE52001	
	23,53	1	BE52002	
	107,58	1	BE52003	

Adaptador de 3/8" para puntas de 10 mm



**BE504902**

			€		
10 mm	28 mm	10,37	1	BE504902	

Puntas hexagonales serie larga (10 mm)



**BE5049H\_L**

			€		
4 mm	75 mm	22,78	1	BE5049H4L	
5 mm	75 mm	22,78	1	BE5049H5L	
6 mm	75 mm	22,78	1	BE5049H6L	
7 mm	75 mm	22,78	1	BE5049H7L	
8 mm	75 mm	22,78	1	BE5049H8L	
10 mm	75 mm	22,78	1	BE5049H10L	
10 mm	115 mm	11,06	1	BE5032H10EL	
12 mm	75 mm	30,58	1	BE5049H12L	

\* Hasta agotar existencias





Caja 5 Puntas XZN, 10mm serie larga  
75mm



**BE5049M L**

	L	€		
M5	75 mm	22,78	1	BE5049M5L
M6	75 mm	22,78	1	BE5049M6L
M8	75 mm	22,78	1	BE5049M8L
M10	75 mm	22,78	1	BE5049M10L
M12	75 mm	30,58	1	BE5049M12L

Juego puntas TORX 49 piezas



**BE5049t**

	L	kg	€		
55 x 190 x 320 mm	3.54 kg	117,89	1	BE5049T	

Caja 5 Puntas TORX® inviolable, 10mm



**BE5049T HL**

	L	€		
TR20	75 mm	22,78	1	BE5049T20HL
TR25	75 mm	22,78	1	BE5049T25HL
TR27	75 mm	22,78	1	BE5049T27HL
TR30	75 mm	22,78	1	BE5049T30HL
TR40	75 mm	22,78	1	BE5049T40HL
TR45	75 mm	22,78	1	BE5049T45HL
TR50	75 mm	22,78	1	BE5049T50HL
TR55	75 mm	22,78	1	BE5049T55HL
TR60	75 mm	33,31	1	BE5049T60HL
TR70	100 mm	33,31	1	BE5049T70HL
TR80	70 mm	33,31	1	BE5049T80HL
TR30	200 mm	22,89	1	BE5049T30HXL
TR40	200 mm	22,89	1	BE5049T40HXL
TR45	200 mm	22,89	1	BE5049T45HXL

Caja 5 puntas TORX® 10 mm, serie larga

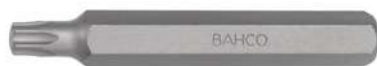

**BE5049T L**

	L	€		
T20	75 mm	22,25	1	BE5049T20L
T25	75 mm	22,25	1	BE5049T25L
T27	75 mm	22,25	1	BE5049T27L
T30	75 mm	22,25	1	BE5049T30L
T40	75 mm	22,25	1	BE5049T40L
T45	75 mm	22,25	1	BE5049T45L
T50	75 mm	22,25	1	BE5049T50L
T55	75 mm	22,25	1	BE5049T55L
T55	115 mm	12,21	1	BE5032T55EL

**HERRAMIENTAS PARA SISTEMAS DE ESCAPE**

Extractor de humos de accionamiento neumático



**BUCPE**

L		€		
5000 mm	1263 x 306 x 300 mm	776,63	1	BUCPE
105 mm	15 x 105 x 105 mm	6,94	1	BUCPEF1
121 mm	60 x 121 x 121 mm	80,24	1	BUCPEF

Opcional: Manguito extensible de 3m (BUCPE3SH) y tubo doble de escape (BUCPE3SDH)

Extensión de manguera para BUCPE



**BUCPE3SH**

L	Ø	€		
3000 mm	63,5 mm	206,03	1	BUCPE3SH

Manguito extensible de 3mm para BUCPE



**BUCPE3SDH**

L	€		
420 x 530 x 3000 mm	3000 mm	209,77	1 BUCPE3SDH

Vaso de 1/2" para sondas lambda



**7812**

Ø	L	€		
22 mm	78 mm	13,94	100	7812

Alicate universal para escapes



**BUC50**

Ø	L	€		
65 mm	305 mm	66,57	1	BUC50

Alicate para desmontaje de escapes



**BUC110**

		€		
360 mm	50 x 65 x 360 mm	47,85	1	BUC110

Llaves para filtros de aceite/combustible



**BE60FW**

		€		
57-120 mm	18 x 95 x 325 mm	62,78	5	BE60FW

Llave de filtro de cadena



**BE64520/BE64350**

		€		
350 mm	60-105 mm	54,78	1	BE64350
350 mm	60-105 mm	40,91	1	BE64350CH
520 mm	60-160 mm	65,19	1	BE64520
520 mm	60-160 mm	51,52	1	BE64520CH

Separador tramos de escape universal



**BUC100**

		€		
34-54 mm	320 mm	104,02	1	BUC100

Llave de fleje



**BE611**

		€		
65-105 mm	25 x 55 x 210 mm	36,66	12	BE61110
65-105 mm	1 x 12 x 382 mm	6,11	100	BE61110-1
100-155 mm	37 x 75 x 275 mm	39,63	12	BE61155
100-155 mm	1 x 12 x 529 mm	7,93	1	BE61155-1

Llave con cinta de goma



**BE66152A**

		€		
150 mm	95 x 170 x 220 mm	22,42	6	BE66152A

**HERRAMIENTAS Y EQUIPAMIENTOS PARA CAMBIOS DE ACEITE**

Llave para filtro de combustible HDi 108mm



**BE60F108**

		€		
3/8 in	108 mm	34,80	50	BE60F108

Llave de fleje para filtros de aceite con mango de goma



**BE62**

		€		
65-105 mm	42.5 x 57 x 249 mm	39,33	10	BE62110
110-155 mm	42.5 x 85 x 314 mm	42,65	10	BE62155

Llave de filtro 3 garras planas



**BE65F65120**

		€		
3/8 in	65-120 mm	15,26	12	BE65F65120



Llaves magnéticas de 3 bocas para filtros de aceite con anchura de apertura de 65 a 120 mm



### BE65R65120

		€		
3/8-1/2 in	65-120 mm	<b>30,51</b>	1	BE65R65120

Llaves magnéticas de 3 mordazas para filtros de aceite con anchura de apertura de 80 a 120 mm



### BE65R80120

		€		
3/8-1/2 in	80-119 mm	<b>116,49</b>	1	BE65R80120

Llaves magnéticas de 3 mordazas para filtros de aceite con anchura de apertura de 106 a 160 mm



### BE65R106160

		€		
1/2 in	105-160 mm	<b>135,91</b>	1	BE65R106160

Juego de cazoletas para filtros de aceite



### BE630

	€	
87 x 505 x 610 mm	<b>191,38</b>	3 BE630

Cazoletas para filtro individuales



### BE630\_Parts

		€	
66 mm	Fiat, Renault	<b>13,86</b>	1 BE630666F
64 mm	Daihatsu, Fiat, Nissan, Toyota	<b>13,86</b>	12 BE6306514F
65-66 mm	Daihatsu, Toyota	<b>13,86</b>	12 BE630656714F
66 mm	Ford, Mazda, Subaru	<b>13,86</b>	1 BE6306814F
73 mm	Alfa Romeo, Lexus, Toyota	<b>13,86</b>	1 BE6307314F
74 mm	Audi, Chrysler, GM, Rover	<b>13,86</b>	1 BE6307415F
74-76 mm	Audi, Ford, Mercedes Benz, Opel, VW	<b>13,86</b>	12 BE630747615F
74-75 mm	Audi, Ford, Isuzu, Mercedes Benz, Opel, VW	<b>13,86</b>	1 BE630757715F
76 mm	Fiat, Mercedes Benz, Renault	<b>13,86</b>	12 BE6307612F
74 mm	Audi, BMW, Mercedes Benz, Opel, Porsche, VW	<b>13,86</b>	12 BE6307614F
74 mm	Ford	<b>13,86</b>	1 BE6307630F
74 mm	Fiat, Lancia	<b>13,86</b>	1 BE630768F
78 mm	Ford, Honda, Nissan, Toyota	<b>13,86</b>	12 BE6307815F
80 mm	Honda, Isuzu, Mazda, Nissan, Opel, Subaru, Toyota	<b>13,86</b>	1 BE6308015F
80-82 mm	Acura, Honda, Mazda, Nissan, Subaru, Toyota	<b>13,86</b>	1 BE630808215F
	Mercedes Benz, Jeep, Chrysler	<b>17,00</b>	12 BE6308414F
86 mm	Volvo	<b>13,86</b>	1 BE6308616F
86 mm	Audi, Citroen, Peugeot, Renault, VW	<b>13,86</b>	1 BE6308618F

		€	
89 mm	Honda, Isuzu, Mitsubishi	<b>13,86</b>	12 BE6309015F
92 mm	Fiat, Lancia	<b>13,86</b>	1 BE6309210F
92 mm	Audi, Ford, Honda, Mazda, Mitsubishi, Nissan, Opel, Porsche, Renault, Volvo, VW	<b>13,86</b>	1 BE6309315F
93 mm	Ford	<b>13,86</b>	1 BE6309336F
93 mm	Audi, VW	<b>13,86</b>	1 BE6309345F
95 mm	Alfa Romeo, Chrysler, Ford, Toyota	<b>13,86</b>	1 BE6309515F
96 mm	Audi, Renault, VW	<b>13,86</b>	1 BE6309618F
101 mm	Isuzu, Mitsubishi	<b>13,86</b>	25 BE63010015F
24 mm	BMW	<b>26,78</b>	50 BE630246F
106 mm	Fiat, MAN, Scania	<b>13,86</b>	1 BE63010615F
27 mm	Mercedes Benz	<b>26,78</b>	50 BE630276F
107 mm	Volvo	<b>13,86</b>	1 BE63010815F
32 mm	GM, Mercedes Benz, Opel, Saab	<b>26,78</b>	50 BE630326F
108 mm	Renault	<b>13,86</b>	1 BE63010818F
36 mm	BMW, Ford, Mercedes Benz, Opel, Rover, VW	<b>26,78</b>	100 BE630366F
38 mm	BMW, Opel, Volvo	<b>26,78</b>	50 BE630386F
66.5 mm	Daihatsu, Toyota	<b>26,78</b>	25 BE63066514F

Llave de filtro de aceite de 27 mm para Ford y Grupo PSA



### BE6302712F

		€	
1/2 in	27 mm	<b>23,33</b>	5 BE6302712F

Llave para filtro de aceite para Toyota, Lexus, Subaru, Daihatsu con 4 cilindros (1,8 a 2,0L)



### BE63064514F1

		€	
Toyota, Lexus, Subaru, Daihatsu 4 cylinders (1.8-2.0l)	64.5 mm	<b>24,27</b>	1 BE63064514F1

Llave para filtro de aceite para Toyota, Lexus, Subaru, Daihatsu con 4, 6 o 8 cilindros (2,5L a 5,7L)



### BE63064514F2

		€		
64.5 mm	Toyota, Lexus, Subaru, Daihatsu 4, 6, 8 cylinders (2.5-5.7L)	24,82	1	BE63064514F2

Cazoleta para filtros de aceite 74 mm 14 caras



### BE6307414F

		€		
14	1	19,99	10	BE6307414F

Llave para tapón de carter con sección cuadrada



### BE68

		€		
8 in	265 mm	32,34	12	BE6810Z
8 in	235 mm	6,78	1	BE68
8 x 10 mm	270 mm	13,73	1	BE6810

BE68: Cuadrado 8mm BE6810: Cuadrado 8-10mm

Extractor bomba sumidero 1/4" VW-AUDI



### BE6701VAG

		€		
10 x 50 x 125 mm	0.02 kg	24,97	1	BE6701VAG

Juego de 17 vasos para cambio de aceite



### BE6217

	€		
55 x 105 x 220 mm	84,60	1	BE6217

Vasos para cambio de aceite de 3/8"



### BE621701-BE621717

	mm	€		
6	8 mm	6,61	1	BE621701
6	9 mm	6,61	1	BE621702
6	10 mm	6,61	1	BE621703
6	12 mm	6,61	1	BE621704
6	13 mm	6,61	1	BE621705
6	14 mm	6,61	1	BE621706
6	17 mm	6,61	1	BE621707
4	8 mm	6,61	1	BE621708
4	9.5 mm	6,61	1	BE621709
4	10 mm	6,61	1	BE621710
4	10.5 mm	6,61	1	BE621711
4	11 mm	6,61	1	BE621712
4	12 mm	6,61	1	BE621713
4	13.1 mm	6,61	1	BE621714
4	10 mm	6,61	1	BE621715
3	10 mm	14,51	1	BE621716
xZN	M16 mm	14,51	1	BE621717

Juego de tapones y arandelas para cárter



### BOD10P64

	€		
68 x 225 x 280 mm	137,31	8	BOD10P64

Juegos de tapones y arandelas para cárter



### BOD10

	€		
34 x 93 x 105 mm	53,21	1	BOD101
35 x 95 x 105 mm	56,27	1	BOD102
33 x 93 x 105 mm	56,27	1	BOD103
33 x 93 x 105 mm	60,82	1	BOD104
33 x 93 x 105 mm	63,86	1	BOD105
95 x 105 x 35 mm	69,20	1	BOD106

Juego tapones y arandelas



### BOD10XNWS

	€		
M13x1.25	39,67	1	BOD101NWS
M13x1.5	44,19	1	BOD102NWS
M15x1.5	39,67	1	BOD103NWS
M17x1.5	43,70	1	BOD104NWS
M20x1.5	43,70	1	BOD105NWS
M22x1.5	58,53	1	BOD106NWS





Recogedora de aceite por gravedad y aspiración, con cámara de visualización 90L



**BOD8903A**

	€		
1700 x 419 x 608 mm	825,17	1	BOD8903A

Recogedora de aceite por gravedad, 90L



**BOD8901**

		€		
1000 x 413 x 630 mm	32 kg	568,60	1	BOD8901

Adaptador para juego BOD6080P12



**BOD6080P12-11**

	€		
105 g	24,90	1	BOD6080P12-11

Aceiteras



**BOD4200/BOD4500**

		€		
0.2l	158 x 86 x 128 mm	10,12	1	BOD4200
0.5l	158 x 86 x 128 mm	12,34	1	BOD4500

Recogedora de aceite por gravedad y aspiración, 90L



**BOD8902**

		€		
1000 x 413 x 632 mm	38 kg	735,03	1	BOD8902

Embudo extensible para Aspiroil



**BOD8901AC1**

	€		
620 x 620 x 150 mm	91,71	1	BOD8901AC1

Equipo de llenado de cambios automáticos



**BOD6080P12**

	€		
595 x 255 x 330 mm	450,74	1	BOD6080P12

Tanque 8L

Embudo 1,2L



**BOD301200**

	€		
225 x 165 x 165 mm	29,13	1	BOD301200



Recogedora de aceite



**BOD2008**

		€		
8 l	115 x 325 x 590 mm	46,45	1	BOD2008

Envase de 2L con boca flexible



**BOD2FS**

		€		
2 l	330 x 130 x 380 mm	15,86	20	BOD2FS

Bomba de engrase profesional



**BOD5HD400**

	€		
60 x 115 x 360 mm	56,80	1	BOD5HD400

Recogedora de aceite



**BOD1016**

		€		
16 l	170 x 450 x 570 mm	40,23	1	BOD1016

Bomba de Barril rotativa



**BOD70**

	€		
230 x 250 x 1330 mm	157,09	1	BOD70

Bomba de engrase universal



**BOD5400/BOD5450**

	€		
55 x 120 x 390 mm	36,79	1	BOD5400
65 x 125 x 385 mm	61,13	1	BOD5450

Macho roscado para tapón de aceite



**BOD10XT**

		€		
92 mm	M13x1.25	18,98	1	BOD101T
70 mm	M13x1.5	23,65	1	BOD102T
70 mm	M15x1.5	18,98	1	BOD103T
70 mm	M17x1.5	24,42	1	BOD104T
70 mm	M20x1.5	26,90	1	BOD105T
70 mm	M22x1.5	23,00	1	BOD106T

Bomba de trasvase para 50-205L con conexiones 1/2" y 2"



**BOD60**

	€		
875 x 57 x 245 mm	54,10	1	BOD60

**HERRAMIENTAS Y EQUIPOS PARA SISTEMAS DE FRENADO**

Tester para líquido de frenos, en pluma



**BBR100**

	€		
20 x 20 x 150 mm	48,54	1	BBR100



Comprobador líquido de frenos



**BBR110**

	€		
35 x 65 x 160 mm	104,02	1	BBR110

Llaves para sangradores de freno



**BBR501011-12**

		€		
10 / 11 mm	3/8 in	74,20	50	BBR501011
12 / 14 mm	3/8 in	74,20	50	BBR50121314*

Purgador de frenos



**BBR350**

		€		
1/4" in	300 x 125 x 125 mm	206,65	1	BBR350

Purgador electrico de frenos 12V



**BBRBB12**

		€		
895 x 390 x 395 mm	14.6 kg	1.766,26	1	BBRBB12

Juego de adaptadores para tapones de líquido de frenos



**BBRAS14**

		€		
PN5 in	85 x 350 x 445 mm	299,93	4	BBRAS14

1 kit de accesorios para adaptadores

Adaptadores para tapones de líquido de frenos



**BBRAS14-01/BBRAS14-14**

		€		
PN5 in	Universal	55,57	1	BBRAS14-01
PN5 in	Honda	26,78	1	BBRAS14-02
PN5 in	Honda Accord	23,81	1	BBRAS14-03
PN5 in	Universal	35,69	1	BBRAS14-04
PN5 in	Chrysler, Jeep, Plymouth	7,94	1	BBRAS14-05
PN5 in	Chrysler, Jeep, Plymouth, Dodge	8,93	1	BBRAS14-06
PN5 in	Nissan	12,91	1	BBRAS14-07
PN5 in	Alfa Romeo, Fiat, Peugeot, Citroën, Audi, BMW, Jaguar, Land-Rover, Mercedes, Porsche, Renault, Saab, VW, Volvo, Chrysler, Daewoo, Ford, Kia, Mazda, Mini, etc	14,67	1	BBRAS14-08
PN5 in	Hyundai, Mitsubishi, Nissan, Subaru, Chrysler, Dodge, Ford, etc.	15,25	1	BBRAS14-09
PN5 in	GM Models and Mazda	12,43	1	BBRAS14-10
PN5 in	Toyota and Lexus	67,91	1	BBRAS14-11
N/A in	Holder for universal adaptor	9,81	1	BBRAS14-12
N/A in	Syringe	22,25	1	BBRAS14-13
N/A in	Hooks, chains and roulettes for BBRAS14-01 and BBRAS14-04	10,91	1	BBRAS14-14

Juego galgas para pastillas de freno



**BBRPTG1**

	€		
68 g	21,20	10	BBRPTG1

Comparador con soporte magnético



**1154**

230 x 50 x 75 mm € 145,71 1 1154

1154-DG

1154-MB

Reloj comparador



**1154-DG**

0-10 mm 0.01 mm € 79,41 1 1154-DG

Rango medición: 0-10mm Incremento medición: 0,01mm

Base magnética



**1154-MB**

70 x 96 x 297 mm 230 + 150 mm € 58,89 1 1154-MB

Calibre de aluminio

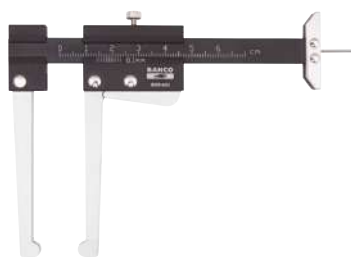

**BBR400**

6 x 89 x 120 mm € 38,83 1 BBR400

Calibre digital para discos de freno



**BBR420**

0-60 mm 35 x 104 x 176 mm € 87,98 50 BBR420

Calibre para discos y tambores de freno.



**BBR410**

20 x 210 x 280 mm 0.610 kg € 52,68 24 BBR410

Calibre digital para discos y tambores de freno

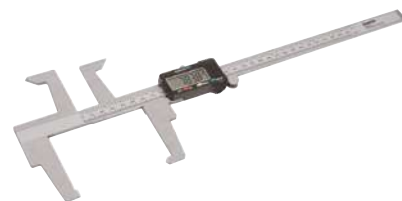

**BBR405**

460 mm € 203,71 20 BBR405

Cepillo para limpiar discos de freno



**783**

223 mm € 13,99 1 783

Reposicionador neumático pistones de frenos



**BBR320**

3/8 in 1/4" in € 103,32 1 BBR320

\* Hasta agotar existencias



Set para calibre de frenos universal de 50 piezas



### BBR300P50

		€		
82 x 350 x 425 mm	5.56 kg	271,82	4	BBR300P50

Juego de 9 vasos de 1/2" con punta TORX® de impacto para frenos



### BBR203P9

	€		
68 x 225 x 225 mm	120,13	1	BBR203P9

BBR203P925, BBR203P960,  
BBR203P930, BBR203P927,  
BBR203P920, BBR203P945,  
BBR203P955, BBR203P940,  
BBR203P950

Vasos impacto Torx® 1/2" para frenos



### BBR203P920-BBR203P960

		€		
T20	78 mm	15,93	1	BBR203P920
T25	78 mm	15,93	1	BBR203P925
T27	78 mm	15,93	1	BBR203P927

		€		
T30	78 mm	15,93	1	BBR203P930
T40	78 mm	15,93	1	BBR203P940
T45	78 mm	15,93	1	BBR203P945
T50	78 mm	15,93	1	BBR203P950
T55	78 mm	16,87	1	BBR203P955
T60	78 mm	16,87	1	BBR203P960

Juego de 6 vasos de 1/2 de impacto XZN para frenos



### BBR201P6

	€		
68 x 225 x 225 mm	83,63	8	BBR201P6

BBR201P67814, BBR201P67816,  
BBR201P67818, BBR201P64018,  
BBR201P64014, BBR201P64016

Vasos impacto 1/2" con punta XZN



### BBR201P64014-BBR201P67818

		€		
M14	40 mm	8,57	1	BBR201P64014
M16	40 mm	8,57	1	BBR201P64016
M18	40 mm	8,81	1	BBR201P64018
M14	78 mm	9,87	1	BBR201P67814
M16	78 mm	9,87	1	BBR201P67816
M18	78 mm	10,78	1	BBR201P67818

Juego de vasos de 1/2 de perfil pentagonal, para freno de mano



### BBR202P4

	€		
43 x 90 x 200 mm	47,13	1	BBR202P4
	7,00	1	BBR202P410
	7,00	1	BBR202P414
	8,57	1	BBR202P419
	8,57	1	BBR202P455

3 vasos 10,14 y 19mm 1 vaso con punta 10mm

Juego para extracción e instalación de muelles de freno



### BBR210P3

	€		
80 x 270 x 375 mm	159,67	1	BBR210P3
25 x 59 x 182 mm	102,35	1	BBRS210P*
75 x 270 x 350 mm	116,99	1	BBRS210P2

Tenaza para muelles de freno con cabeza oscilante



### BBR6135

	€		
335 mm	67,96	1	BBR6135

Alicate para muelles de freno



**BBR6131**

	€		
210 mm	33,87	1	BBR6131

Alicate para muelle de freno de mano



**BBR204**

		€		
235 mm	21,9 mm	35,89	6	BBR204

Alicate metálico para latiguillos



**BBR150i**

		€		
13.5 mm	10 x 52 x 165 mm	17,81	24	BBR150i

Abocinador



**BBRFKM1**

		€		
141 x 115 x 195 mm	1551 g	193,29	12	BBRFKM1*

**HERRAMIENTAS PARA RUEDAS Y TRANSMISION**

Llaves en cruz



**29-B/BWXW1/BWXW2**

<b>S</b>		€		
17,19,21 mm	1/2 in	33,29	1	29-B
17,19,22 mm	1/2 in	36,06	1	BWXW1
24,27,32 mm	3/4 in	108,17	4	BWXW2
17, 19, 21, 22 mm		33,29	1	BWXW3
24, 27, 32, 38 mm		112,35	1	BWXW4

Juegos de vasos para ruedas



**BWSS12P3**

		€		
17, 19, 21 mm	45 x 125 x 145 mm	41,47	20	BWSS12P3

BWSS12P317, BWSS12P319, BWS-S12P321

Juego de vasos de impacto para ruedas 1/2"



**BWSS12P5**

		€		
17, 19, 21, 22, 24 mm	175 x 240 x 50 mm	63,80	1	BWSS12P5

BWSS12P319, BWSS12P317, BWSS12P524, BWSS12P522, BWS-S12P321

Vasos específicos para automoción



**BWSS12P**

		€		
1/2 in	17 mm	13,73	1	BWSS12P317
1/2 in	19 mm	14,57	1	BWSS12P319
1/2 in	21 mm	14,57	1	BWSS12P321
1/2 in	22 mm	16,63	1	BWSS12P522
1/2 in	24 mm	16,63	1	BWSS12P524

Vaso de impacto para ruedas, 15mm



**BWSMB15**

	€		
15 mm	14,89	25	BWSMB15

\* Hasta agotar existencias





Vaso impacto 17mm para Mercedes



**BWSMB17**

	€		
17 mm	16,63	1	BWSMB17

Juego vasos impacto 1/2" para ruedas



**BWSS12PL**

		€		
1/2 in	17 mm	24,69	1	BWSS12P317L
1/2 in	19 mm	24,82	1	BWSS12P319L
1/2 in	21 mm	24,97	1	BWSS12P321L*

Juego vasos para tuercas redondeadas



**BWTSP6**

	€		
55 x 105 x 217 mm	97,38	1	BWTSP6

Vaso de impacto antirrobo de 21 mm para Hyundai y KIA



**BWSHK21**

		€		
1/2" in	21 mm	17,33	25	BWSHK21

Juego de vasos largos torsión 1/2", 17, 19 y 21mm



**BWTSP3L**

	€		
68 x 225 x 150 mm	136,60	1	BWTSP3L

BWTSP619, BWTSP617, BWTSP622, BWTSP621, BWTSP624

Vasos para tuercas redondeadas



**BWTSP617-BWTSP624**

		€		
17 mm	1/2 in	19,50	1	BWTSP617
19 mm	1/2 in	19,50	1	BWTSP619
21 mm	1/2 in	19,50	1	BWTSP621
22 mm	1/2 in	20,24	1	BWTSP622
24 mm	1/2 in	20,24	1	BWTSP624

Juego vasos de impacto para ruedas 17, 19 y 21mm



**BWSS12P3L**

		€		
17, 19, 21 mm	68 x 225 x 225 mm	99,97	1	BWSS12P3L

Vaso largo torsión 1/2" 150mm



**BWTS317L-BWTSP321L**

		€		
1/2 in	17 mm	41,54	1	BWTS317L
1/2 in	19 mm	45,07	1	BWTS319L
1/2 in	21 mm	48,88	1	BWTS321L

Juego de 7 vasos para ruedas



**BWTSP7**

	€		
52 x 117 x 207 mm	274,33	1	BWTSP7

1/2": 22, 24, 27, 32 mm & 3/4": 36, 41 mm

Vasos específicos para automoción



**BWTSP16**

	€		
48 x 125 x 245 mm	300,34	1	BWTSP16
3/8": 8, 10, 11, 12, 13, 14, 16, 17, 18, 19 mm & 1/2": 21, 22, 24, 27 mm			

Vasos para ruedas



**BWTSP**

		€		
8 mm	3/8 in	24,93	1	BWTSP1608
10 mm	3/8 in	15,73	1	BWTSP1610
11 mm	3/8 in	15,73	1	BWTSP1611
12 mm	3/8 in	15,73	1	BWTSP1612
13 mm	3/8 in	15,73	1	BWTSP1613
14 mm	3/8 in	15,73	1	BWTSP1614
16 mm	3/8 in	16,85	1	BWTSP1616
17 mm	3/8 in	16,85	1	BWTSP1617
18 mm	3/8 in	16,85	1	BWTSP1618
19 mm	3/8 in	16,85	1	BWTSP1619
21 mm	1/2 in	32,86	1	BWTSP1621
22 mm	1/2 in	33,21	1	BWTSP1622
24 mm	1/2 in	33,98	1	BWTSP1624
27 mm	1/2 in	34,63	1	BWTSP1627
32 mm	1/2 in	80,46	1	BWTSP732
36 mm	3/4 in	95,50	1	BWTSP736
41 mm	3/4 in	111,23	1	BWTSP741

Set 5 barras de torsión



**BWTB12P5**

		€		
68 x 225 x 280 mm	1.74 kg	123,44	1	BWTB12P5

BWTB12P90, BWTB12P100, BWTB12P110, BWTB12P120, BWTB12P135

Barra de torsión



**BWTBP1290-BWTB12P200**

	Nm	€		
200 mm	100 N-m	24,27	1	BWTB12P100
200 mm	110 N-m	24,27	1	BWTB12P110
200 mm	120 N-m	24,27	1	BWTB12P120
200 mm	135 N-m	24,27	1	BWTB12P135
200 mm	150 N-m	24,27	1	BWTB12P150
200 mm	160 N-m	24,27	1	BWTB12P160
200 mm	175 N-m	24,27	1	BWTB12P175
200 mm	190 N-m	24,27	1	BWTB12P190
200 mm	200 N-m	24,27	1	BWTB12P200
200 mm	90 N-m	24,27	1	BWTB12P90

Barra de torsión de impacto 1"



**BZWTB**

		€		
32 mm	450 N-m	181,78	1	BZWTB0132450*
32 mm	600 N-m	181,78	1	BZWTB0132600*

Bolsa para tornillos y vasos para ruedas



**BWBB**

		€		
0.023 kg	180 x 1 x 300 mm	8,66	200	BWBB

Juego de machos y terrajas



**BWHTRS12**

		€		
225 x 67 x 225 mm	1350 g	226,61	15	BWHTRS12*

Una llave hexagonal para ajustar las terrajas

\* Hasta agotar existencias



Desmontador de neumáticos



**38-8 - 38-24**

L	€	Icon 1	Icon 2
200 mm	16,63	5	38-8
300 mm	20,81	5	38-12
400 mm	26,36	5	38-16
500 mm	33,29	2	38-20
600 mm	41,60	1	38-24

Desmontador de neumáticos



**38A**

L	€	Icon 1	Icon 2
200 mm	6,64	25	38A-08
240 mm	7,34	25	38A-10
304 mm	8,32	1	38A-12
382 mm	9,71	25	38A-15
537 mm	19,43	1	38A-21
655 mm	22,19	1	38A-26

Desmontador de neumáticos Curvado



**38C**

L	€	Icon 1	Icon 2
645 mm	24,97	1	38C-26

Desmontador de neumáticos, curvado



**39-24**

L	€	Icon 1	Icon 2
605 mm	27,76	1	39-24

Cuñas para ruedas



**BWC1**

Icon 1	€	Icon 2	Icon 3
75 x 77 x 110 mm	17,77	25	BWC1

Pinza equilibrado de ruedas



**BWP150**

Icon 1	€	Icon 2	Icon 3
20 x 87 x 255 mm	24,97	1	BWP150

Medidor digital de profundidad de neumático



**BWTDG1**

L	Icon 1	€	Icon 2	Icon 3
0 - 25 mm	30 x 76 x 156 mm	39,33	50	BWTDG1

Medidor de presión de neumáticos



**BWTPG1**

Icon 1	€	Icon 2	Icon 3
20 x 90 x 394 mm	54,92	10	BWTPG1*

Herramientas de mantenimiento del sistema de monitorización de la presión de los neumáticos



**BWTPMSS9**

Icon 1	g	€	Icon 2	Icon 3
68 x 225 x 225 mm	1049 g	331,45	8	BWTPMSS9

Herramientas de mantenimiento del sistema de monitorización de la presión de los neumáticos



**BWTVCTT355**

Icon 1	Icon 2	€	Icon 3	Icon 4
0.45 N·m	0.33 lbf·ft	28,97	1	BWTVCTT355

Tapones de deflación de la boquilla del neumático



**BWTMSS4C**

		€		
27 x 59 x 108 mm	60 g	35,37	25	BWTMSS4C

Juego de vasos de impacto de 1/2" para tuercas de bujes



**BT15P5**

	€		
60 x 85 x 255 mm	83,63	1	BT15P5

2 Vasos Hex: 14 y 17mm 3 Vasos BiHex: 24, 30, 32mm

Vaso de impacto de 1/2" bihexagonales



**BT15P524-BT15P536**

		€		
1/2 in	24 mm	12,99	1	BT15P524
1/2 in	30 mm	15,61	1	BT15P530
1/2 in	32 mm	16,81	1	BT15P532
1/2 in	36 mm	22,41	1	BT15P536

Vasos de impacto 3/4", 8 caras



**BHVIS08**

		€		
3/4 in	95 mm	180,29	1	BHVIS0895
3/4 in	100 mm	199,01	1	BHVIS08100
3/4 in	115 mm	203,46	1	BHVIS08115
	109 mm	213,17	1	BHVIS109BPW12
	120 mm	247,55	1	BHVIS120BPW16

Vasos de impacto de pared fina, 1"



**BHVIS12 / BHVIS06**

		€		
12	68 mm	88,74	1	BHVIS1265
6	70 mm	100,55	1	BHVIS0670
6	77 mm	133,14	1	BHVIS0677
6	80 mm	141,46	1	BHVIS0680
6	85 mm	208,03	1	BHVIS0685
6	90 mm	220,50	1	BHVIS0690
6	95 mm	346,71	1	BHVIS0695
6	100 mm	520,08	1	BHVIS06100
6	105 mm	589,41	1	BHVIS06105

Vasos de impacto para BPW



**BHVISxxBPW**

		€		
3/4 in	111 mm	223,29	1	BHVIS111BPW12
3/4 in	80 mm	158,09	1	BHVIS80BPW12
3/4 in	95 mm	163,65	1	BHVIS95BPW9

Plato extractor de cubos de ruedas



**BWHEPSSH8**

		€		
12 to	#4-5/116-135 mm	997,30	1	BWHEPSSH8

Plato extractor de cubos de ruedas con husillo hidráulico



**BWHEPS**

		€		
12 to	#4-5 / 116-135 mm	471,24	1	BWHEPS

**BWHEP**

**BWHEHS**

Plato extractor de cubos de ruedas con martillo deslizante



**BWHEPSH8**

		€		
#4-5 / 116-135 mm	960 x 150 x 150 mm	616,25	1	BWHEPSH8

\* Hasta agotar existencias





Plato extractor de bujes



**BWHEP**

		€		
#4-5 / 116-135 mm	90 x 147 x 147 mm	242,84	1	BWHEP

Martillo de inercia 8Kg



**BWSH8**

	€		
960 x 100 x 100 mm	457,70	1	BWSH8

Compuesto por martillo 5Kg (BWSH5) + Adaptador M18 +Maza adicional 3Kg (BSSHE3)

<b>BWSH5</b>	
<b>BWSH51</b>	
<b>BSSHE3</b>	

Kit de reparación BS52 39-52mm



**BS5228-BS523945**

	€		
28-34 mm	91,53	1	BS5228341
34-40 mm	91,53	1	BS5234401
39-35 mm	91,53	1	BS5239451

Husillo hidráulico 12Tn



**BWHEHS**

		€		
12 to	265-282 mm	253,13	1	BWHEHS

Avance 17mm

Maza de 3Kg



**BSSHE3**

		€		
60 mm	100 mm	104,50	1	BSSHE3

Kit de preparación de abrazaderas



**BE2512005**

		€		
5 mm	12 m	80,44	1	BE2512005

Martillo de inercia 5Kg



**BWSH5**

	€		
100 x 100 x 985 mm	353,20	2	BWSH5

Adaptador M18



**BWSH51**

		€		
M38 mm	M18x38	18,86	1	BWSH51

Alicata para abrazaderas



**BE251200**

	€		
170 mm	102,63	1	BE251200



Expansor neumático de guardapolvos



**BPCVB1**

		€		
25-110 mm	138 x 138 x 455 mm	233,28	6	BPCVB1

Útil para rótulas de dirección



**BS54**

	€		
57 x 57 x 70 mm	66,57	1	BS54

Capacidad de 33-42mm

Útil para ajuste de caída grupo VAG



**BS40VAG**

		€		
22 mm	52 x 92 x 150 mm	65,87	20	BS40VAG

Kit de preparación de abrazaderas



**BE2512008**

		€		
8 mm	15 m	85,98	1	BE2512008

Vaso para el extremo de la barra de acoplamiento.



**BS56**

		€		
1/2 in	57 x 57 x 57 mm	36,31	6	BS56*

Juego colocación/extracción de bujes y rodamientos de ruedas



**BWB14**

	€		
80 x 300 x 525 mm	499,02	2	BWB14

Herramienta para soltar y apretar rótulas axiales



**BS52**

		€		
110 x 315 x 380 mm	3.08 kg	256,56	1	BS52

Vaso excéntrico de ajuste de caída para BMW



**BS45BMW**

		€		
1/2 in	40 x 43 x 43 mm	36,60	20	BS45BMW*

Juego para extracción e instalación de rodamientos



**BT20P26**

	€		
150 x 310 x 535 mm	714,23	1	BT20P26

\* Hasta agotar existencias



Set para extraer e instalar de cojinetes hidráulicos



**BT20P49**

	€		
164 x 520 x 890 mm	2.599,39	1	BT20P49

VW T4 Herramienta para reemplazo de juntas



**4594VWT4**

	€		
245 x 112 x 320 mm	366,58	5	4594VWT4*

Juego de mandriles de centrado para embragues SAC



**BE301CM-SET**

	€		
26 x 81.5 x 200 mm	64,68	50	BE301CM

BE301CM-01, BE301CM-02

Extractor de rótulas, para barras y bielas de dirección



**BS6**

		€		
18 mm	400 mm	55,49	1	BS618
23 mm	400 mm	108,44	1	BS623

Vaso extractor de rótulas grupo PSA



**BS100PSA1**

		€		
56 mm	52 mm	104,61	1	BS100PSA1

Mandriles de centrado para embragues SAC



**BE301CM**

		€		
15.19 mm	174 mm	33,32	20	BE301CM-01
20.26 mm	174 mm	33,32	20	BE301CM-02

Juego de extractores de rótula con husillo hidráulico 12t



**BWHPJ12**

		€		
12 to	70 mm	313,26	4	BWHPJ12

Juego de herramientas para embrague SAC



**BE301**

	€		
80 x 395 x 430 mm	470,47	2	BE301

Centrador de embragues



**BE310**

		€		
68 x 225 x 280 mm	1.14 kg	83,21	8	BE310

## HERRAMIENTAS Y EQUIPOS PARA SUSPENSION

Util para brazo de suspensión



**BS25**

		€		
20 N·m	200 kg	<b>234,60</b>	1	BS25

Compresor de muelles para Macpherson



**BS15**

	€		
125 x 425 x 510 mm	<b>686,50</b>	1	BS15

Desmontador neumático de amortiguadores



**BS30PG**

		€		
1180 x 500 x 625 mm	24 kN	<b>2.548,43</b>	1	BS30PG

Plato/Adaptador para amortiguadores de vehículos deportivos con anilla de regulación



**BS10AC2**

		€		
400 x 400 x 200 mm	1 kg	<b>610,22</b>	1	BS10AC2

Extensión de altura móvil



**BS30AC1**

	€		
336 x 545 x 450 mm	<b>493,72</b>	1	BS30AC1

Juego universal extractor de copelas de suspensión



**BS1000**

	€		
70 x 405 x 575 mm	<b>402,19</b>	1	BS1000
	<b>18,29</b>	1	BS100001
	<b>18,29</b>	1	BS100002



€



18,29	1	BS100003
18,29	1	BS100004
18,29	1	BS100005
18,29	1	BS100006
18,29	1	BS100007
18,29	1	BS100008
18,29	1	BS100009
14,96	1	BS100010
14,96	1	BS100011
14,96	1	BS100012
12,45	1	BS100013
12,45	1	BS100014
12,45	1	BS100015
12,45	1	BS100016
12,45	1	BS100017
12,45	1	BS100018
12,45	1	BS100019
12,45	1	BS100020
12,45	1	BS100021
14,96	1	BS100022
14,96	1	BS100023
14,96	1	BS100024
14,96	1	BS100025
14,96	1	BS100026
14,96	1	BS100027
14,96	1	BS100028
12,45	1	BS100029
12,45	1	BS100030
12,45	1	BS100031
12,45	1	BS100032
12,45	1	BS100033
12,45	1	BS100034
16,72	1	BS100035
16,72	1	BS100036
16,72	1	BS100037
16,72	1	BS100038
16,72	1	BS100039

## HERRAMIENTAS PARA BATERÍAS Y SISTEMAS ELECTRICOS

Protector de memorias toma OBDII



**BELMS12OBDL**

	€		
40 x 70 x 140 mm	<b>74,51</b>	8	BELMS12OBDL

\* Hasta agotar existencias



Arrancador de baterías de 12 V 1200 CA



**BBAGM12-1200**

**V CA** €   
12 V 1200 A 572,89 1 BBAGM12-1200

Cargadores electrónicos automáticos para arrancadores



**BBAGMCHG**

€   
70 x 105 x 130 mm 99,72 1 BBAGMCHG

Cables de arranque para baterías



**BBJL**

		€		
16 mm <sup>2</sup>	3 m	42,36	5	BBJL1630
25 mm <sup>2</sup>	3.5 m	98,39	1	BBJL2535
35 mm <sup>2</sup>	4.5 m	130,90	1	BBJL3545

Arrancador de baterías de 12/24 V 2400 / 1200 CA



**BBAGM1224-2400**

**V CA** €   
12/24 V 2400 / 1200 A 1.299,60 1 BBAGM1224-2400

Cable de carga de repuesto para arrancador de 12 V



**BBAGMCAB**

**V** €   
25 x 80 x 200 mm 12 V 20,69 1 BBAGMCAB

Cargador baterías eléctrico 12V-3 A



**BBCE12-3**

**V A** €   
12 V 3 A 102,49 2 BBCE12-3

Batería de repuesto para arrancadores de 12 V



**BBAGMBAT**

**V** €   
12 V 25 A·h 391,47 1 BBAGMBAT

Booster para industria pesada, 12/24V



**BBA1224-3200**

**V CA** €   
12/24 V 3200/1600 A 3.436,38 1 BBA1224-3200

Cargador baterías eléctrico 12V-6A



**BBCE12-6**

**V A** €   
12 V 6 A 122,97 2 BBCE12-6



Cargador baterías 12V



**BBCE12-10**

**V** **A** €   
12V 10A 150,30 2 BBCE12-10

Cargador mantenedor automático 15  
amps para baterías de 12V con Función  
Showroom



**BBCE12-15S**

**V** **A** €   
12V 10/15A 182,62 2 BBCE12-15S

Cargador baterías eléctrico 24V-10A



**BBCE24-10**

**V** **A** €   
24V 10A 204,96 2 BBCE24-10

Cargador de batería 100A



**BBCE12-F100**

**V** **A** €   
12V 4/20/70/100AA 1.448,32 1 BBCE12-F100

Cargador-arrancador de baterías 12/24V



**BBC420-BBC620**

**V** €   
230V 20/1000 A-h 601,20 1 BBC420  
230V 20/1550 A-h 860,80 1 BBC620

Densímetro para baterías



**BB10**

€   
50 x 50 x 285 mm 12,55 1 BB10

Tester digital baterías 12 V



**BBT20**

€   
90 x 160 x 345 mm 101,12 1 BBT20

Comprobador de baterías digital de 12V



**BBT60A**

€   
27 x 95 x 135 mm 221,68 36 BBT60A

Comprobador electrónico de baterías con  
impresora 6-12V



**BBT80**

€   
64 x 130 x 251 mm 627,17 6 BBT80





Multímetro



**BMMTRMS1**

		€		
155 x 60 x 225 mm	0.8 kg	220,69	1	BMMTRMS1

Comprobador de mandos de distancia



**BELTKEY**

	€		
35 x 63 x 160 mm	183,06	1	BELTKEY*

Comprobador eléctrico de funcionamiento de lámparas de vehículo de 24V



**BELT2415A**

		€		
40 x 138 x 205 mm	1.897 kg	371,57	20	BELT2415A

Comprobador de ausencia de tensión de 1000 V, comprobador de tensión sin contacto



**BMVAT1000**

		€		
310 x 50 x 100 mm	0.302 kg	139,99	50	BMVAT1000

Comprobador toma de remolque 7 polos 12V



**BELT127**

	€		
35 x 63 x 160 mm	109,56	1	BELT127*

Comprobador toma remolque 7 polos 24V



**BELT247N**

	€		
55 x 63 x 160 mm	119,27	1	BELT247N

Pinza amperimétrica digital True RMS 1000 A CA/CC



**BDACM1000**

		€		
60 x 143 x 250 mm	0.551 kg	128,39	30	BDACM1000

Comprobador eléctrico de funcionamiento de lámparas de vehículo de 12 V



**BELT1213A**

		€		
40 x 138 x 205 mm	1.726 kg	319,03	1	BELT1213A

Comprobador toma de remolque 7 polos 24 V (24S)



**BELT247S**

	€		
35 x 63 x 155 mm	119,27	1	BELT247S

Soldador de gas profesional



**BGIS125**

		€		
25-125 W	46 x 88 x 295 mm	171,96	20	BGIS125

Funda protectora

Juego universal de útiles para terminales, 16 piezas



**BELTRP16**

	€		
58 x 215 x 265 mm	221,89	1	BELTRP16
	23,33	1	BELTRP1601
	2,21	1	BELTRP1602
	24,51	1	BELTRP1603
	2,21	1	BELTRP1604
	23,33	1	BELTRP1605
	2,21	1	BELTRP1606
	21,88	1	BELTRP1607
	23,33	1	BELTRP1608
	18,48	1	BELTRP1609
	20,47	1	BELTRP1610
	22,76	1	BELTRP1611
	23,80	1	BELTRP1612
	15,60	1	BELTRP1613
	18,46	1	BELTRP1614
	18,46	1	BELTRP1615
	18,46	1	BELTRP1616

Protector de memorias 12V



**BELS12**

	€		
35 x 63 x 160 mm	95,70	1	BELS12

Protector de picos de 12 & 24V



**BELP1224**

	€		
35 x 63 x 160 mm	90,16	1	BELP1224

Pinzas para baterías (conexión rápida) para cargadores BBCE12-10 y BBCE24-10



**BBCEC1**

	€		
68 g	10,11	1	BBCEC1

Conector de terminales (conexión rápida) para cargadores BBCE612-2, BBCE12-3 y BBCE12-6



**BBCER1**

	€		
100 g	10,25	1	BBCER1

Pinzas para baterías (conexión rápida) para cargadores BBCE612-2, BBCE12-3 y BBCE12-6



**BBCEC2**

	€		
68 g	13,61	1	BBCEC2

Conector de terminales (conexión rápida) para cargadores BBCE12-10 y BBCE24-10



**BBCER2**

	€		
100 g	13,61	1	BBCER2

\* Hasta agotar existencias



Cables para cargadores de arrancadores:



**BBBCAB**

Icono	€	Icono	Icono
50 x 125 x 50 mm	12,17	1	BBBCAB-AUZ
50 x 125 x 50 mm	14,43	1	BBBCAB-EU
50 x 50 x 50 mm	12,17	1	BBBCAB-UK

**PRENSAS Y ACCESORIOS**

Prensa de sobremesa 15T



**BH715**

kg	€	Icono	Icono
15.000 kg	1.058,25	1	BH715

Prensa Hidráulica con bomba doble velocidad

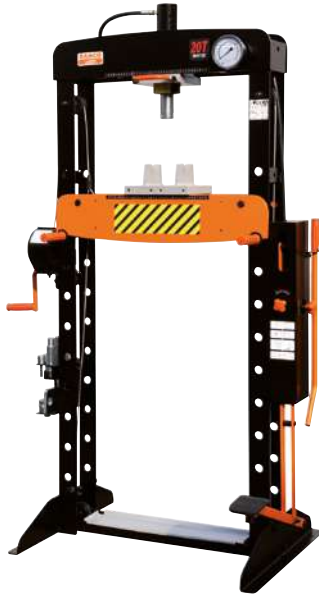

**BH720/BH730/BH750**

kg	€	Icono	Icono
20.000 kg	1.941,74	1	BH720
30.000 kg	2.273,30	1	BH730
50.000 kg	3.339,65	1	BH750

8 mandrinos presión incluidos Pasadores de fijación de mesa autocentrantes

Prensa pistón deslizante y c/pedal 100Tn



**BH7100**

kg	€	Icono	Icono
100000 kg	7.944,64	1	BH7100A

Soportes universales para prensas (30 T)



**BH7PS30**

Icono	€	Icono	Icono
225 x 100 x 275 mm	323,05	2	BH7PS30

Juego de mandrinos para prensas 15T



**BH715-13**

kg	€	Icono	Icono
7.09 kg	152,54	1	BH715-13
7.09 kg	166,39	1	BH720-22

Panel de seguridad para prensas



**BH7\_SG**

Icono	Icono	€	Icono	Icono
530 mm	20 mm	154,82	1	BH720SG
590 mm	20 mm	168,91	1	BH730SG
625 mm	20 mm	182,98	1	BH750SG

Rejilla de seguridad para prensa de 100T



**BH7100SG**

		€		
150 x 593 x 625 mm	5.54 kg	464,20	1	BH7100SG

## EQUIPAMIENTO LIGERO

Mesas multiusos



**BLEMAT1**

		€		
860 x 155 x 780 mm	28.7 kg	448,44	1	BLEMAT1*

Bandeja inferior para mesa multiusos



**BLEMAT1BT**

		€		
50 x 760 x 890 mm	10.5 kg	88,98	1	BLEMAT1BT*

Juego de 4 bolsas protectoras para ruedas y llantas



**BWB1418S4/BWB1922S4**

	€		
355 - 470 mm	75,16	6	BWB1418S4
470 - 560 mm	84,72	6	BWB1922S4*

Bandeja magnética con solapa PVC



**BMR240**

	€		
250 mm	23,59	1	BMR240

Plato magnético



**1419-MD**

	€		
150 mm	12,34	1	1419-MD

Taburete altura ajustable



**BLE305**

	€		
430 x 410 x 430 mm	157,14	1	BLE305

Plato magnético de 1500mm



**BMD150**

	€		
160 mm	13,16	1	BMD150

Taburete para taller con altura regulable



**BLE300**

		€		
380 x 380 x 550 mm	136 kg	192,77	1	BLE300

\* Hasta agotar existencias





Combi Camilla y Asiento



**BLE302**

		€		
135 x 490 x 1010 mm	136 kg	127,36	1	BLE302

Capacidad 135kg

Camilla de perfil bajo 120mm



**BLE301**

		€		
120 x 590 x 1020 mm	136 kg	120,66	1	BLE301

Capacidad 135 Kg

Conjunto camilla y taburete



**BLE304**

		€		
460 x 1020 x 135 mm	116 / 100 kg	171,97	1	BLE304

Cubre asientos de nylon de gran resistencia



**5750**

	€		
1390 mm	18,85	1	5750

Fácilmente lavable

Protector frontal para vehiculos



**5770**

		€		
350 x 300 x 85 mm	990 g	76,02	12	5770

Panel protector para vehiculos



**BBS50**

		€		
900 mm	1.2 mm	56,71	1	BBS50

Centrafaros laser dual



**BLBT100**

	€		
1650 x 500 x 565 mm	1.241,23	1	BLBT100

Riel para BLBT100

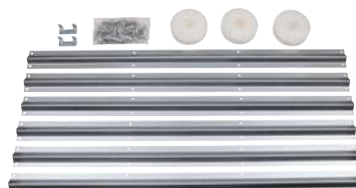

**BLBT100AC1**

		€		
150 x 150 x 1025 mm	7.77 kg	321,82	1	BLBT100AC1

Juego de tres palancas articuladas



**BT10P3**

	€		
80 x 270 x 375 mm	127,58	1	BT10P3

250mm (BT10P325); 300mm(BT10P330) 380mm (BT10P338)



Palanca articulada



**BT10P325-BT10P338**

L	€	Icon	Icon
250 mm	42,15	40	BT10P325
300 mm	46,05	1	BT10P330
380 mm	52,53	1	BT10P338

La cabeza se puede ajustar en 14 posiciones

Set de palancas multiusos largas



**BPBLS4**

Icon	g	€	Icon	Icon
78 x 255 x 1000 mm	9050 g	244,61	2	BPBLS4

BPBL00900, BPBL30900, BPBL70600, BPBL90600

Palanca mutiusos



**BPBL**

L	€	Icon	Icon
930 mm	66,32	5	BPBL00900*
925 mm	66,32	5	BPBL30900
610 mm	58,32	5	BPBL70600*
628 mm	59,32	5	BPBL90600*

**HERRAMIENTAS PARA CARROCERÍA**

Soporte universal con ventosas para lunas



**BBS3BH1**

L	€	Icon	Icon
955 mm	117,89	1	BBS3BH1

Ventosa para soporte universal



**BBS3BH1-VP**

Icon	€	Icon	Icon
60 x 95 x 95 mm	16,67	40	BBS3BH1-VP

Soporte para piezas de carrocería



**BBS3UH**

Icon	kg	€	Icon	Icon
950 x 800 x 1200 mm	20 kg	476,43	1	BBS3UH

2 ruedas fijas 2 giratorias 360° con sistema bloqueo

Ventosa para capacidad 75Kg.



**BBS075**

Icon	L	€	Icon	Icon
160 mm	175 mm	41,74	12	BBS075

Ventosas dobles y correa tensora



**BBS150**

Icon	L	€	Icon	Icon
120 mm	400 mm	133,14	1	BBS150

Limpiador de canal de parabrisas



**BBS106**

Icon	kg	€	Icon	Icon
25 x 25 x 332 mm	0.145 kg	20,32	1	BBS106

Tirador con mango de alambre cortajuntas



**BBS103**

Icon	€	Icon	Icon
25 x 25 x 345 mm	20,81	1	BBS103

\* Hasta agotar existencias



Tirador mango en T de alambre cortajuntas



**BBS102**

	€		
265 mm	12,75	1	BBS102

Pareja de empuñaduras para alambre cortajuntas de parabrisas



**BBS101**

	€		
30 x 80 x 115 mm	31,90	1	BBS101

Cable para cortajuntas de parabrisas 50m



**BBS150S**

	€		
50 m	51,31	1	BBS150R
50 m	59,64	1	BBS150S
50 m	65,19	1	BBS150T

Cortajuntas BBS101

Útil cortajuntas parabrisas



**BBS105**

	€		
20 x 90 x 200 mm	41,60	1	BBS105

Incluye hoja L 25mm

Cuchillo de uretano para lunas / parabrisas



**BBS10450**

		€		
10 x 30 x 450 mm	0.240 kg	28,85	1	BBS10450

Cuchilla trapezoidal de cutter estándar

Juego de tres cuchillas rectas en blíster



**BBS107**

	€		
1 x 18 x 125 mm	11,04	1	BBS107

Medidas: 19, 25, 38mm

Juego de tres cuchillas en 'L'



**BBS108**

	€		
20 x 19 x 88 mm	11,04	1	BBS108

Presentadas en blíster

Juego Extractor Limpiaparabrisas Univ.



**BBS165**

	€		
117 x 25 x 78 mm	117,89	10	BBS165

Juego de extractores para brazos de limpiaparabrisas



**BBS170P13**

	€		
80 x 275 x 375 mm	219,12	1	BBS170P13
	11,30	1	BBS170P131
	11,30	1	BBS170P132

€			
11,30	1	BBS170P133	
11,30	1	BBS170P134	
11,30	1	BBS170P135	
11,30	1	BBS170P136	
11,30	1	BBS170P137	
13,10	1	BBS170P138	
13,97	1	BBS170P139	
17,50	50	BBS165SP4	

Enderezador a inercia para carrocerías 12Kg



**BBS12SH**

L	kg	€		
800 mm	12 kg	448,88	1	BBS12SH

Longitud 800mm

Martillo carrocer cabeza plana lisa



**BBSH1F**

€		
50x30 mm	44,88	1 BBSH1F

Mango de hickory

Martillo carrocer cabeza cuadrillada



**BBSH1M**

€		
50x30 mm	63,04	1 BBSH1M

Mango de hickory

Martillo carrocer cara redonda convexa



**BBSH2C**

€		
40 mm	45,77	1 BBSH2C

Mango hickory genuino

Martillo carrocer cara redonda convexa y otra rectángulo angulado



**BBSH2CA**

€		
40 mm	51,31	12 BBSH2CA

Una cara redonda Convexa (C) Otra cara rectángulo angulado

Martillo-pico para carrocer



**BBSH2CP**

€		
40 mm	46,48	6 BBSH2CP

Cabeza redonda (C) abombada y lisa

Martillo carrocer cabeza redonda plana



**BBSH2F**

€		
40 mm	45,77	6 BBSH2F

Mango hickory

Martillo para carrocer



**BBSH3CF**

€		
40 mm 37 mm	46,82	6 BBSH3CF

F - Cuadrada plana C - Abombada lisa

Martillo para carrocer ligero



**BBSH3CF30**

€		
30 mm 25 mm	49,80	6 BBSH3CF30

Cuadrada (F) Redonda abombada (C)

Martillo carrocer ligero cabeza cuadrillada, redonda plana y lista



**BBSH3FS**

€		
37 mm 40 mm	49,89	6 BBSH3FS

Cabeza cuadrada dentada (SM) redonda plana y lisa (F)

Martillo carrocer cara redonda dentada y cuadrada plana



**BBSH3MF**

€		
30 mm 27 mm	48,60	1 BBSH3MF



Mango repuesto para martillo BBSH



**BBSHWH1**

	€		
160 g	15,94	1	BBSHWH1

Tas Tacón



**BBSDH**

	€		
30 x 60 x 79 mm	55,65	1	BBSDH

Cuchara para carrotero



**BBSS1**

	€		
25 x 56 x 390 mm	106,88	1	BBSS1

Tas americano



**BBSDA**

	€		
30 x 63 x 83 mm	59,90	1	BBSDA

Tas americano ligero



**BBSDT**

	€		
26 x 58 x 120 mm	67,70	6	BBSDT

Palanca para carrotero



**BBSS2**

	€		
150 x 60 x 410 mm	116,33	8	BBSS2

Tas coma



**BBSDC**

	€		
40 x 58 x 128 mm	62,23	6	BBSDC

Tas de cuña



**BBSDW**

	€		
25 x 64 x 112 mm	46,59	6	BBSDW

Palanca pesada para carrotero



**BBSS2L**

		€		
175 x 60 x 520 mm	2.3 kg	121,68	1	BBSS2L

Tas diábolo



**BBSDD**

	€		
55 x 55 x 55 mm	47,13	1	BBSDD

Tas de caucho para carrotero



**BBSDHR**

	€		
40 x 62 x 75 mm	24,85	1	BBSDHR

Núcleo de acero con recubrimiento de goma

Leva para clip de guarnecidos



**2485**

	€		
240 mm	9,59	1	2485

Pinza para tapicería de puertas



**BBS200**



€



65 x 75 x 250 mm

44,38

1 BBS200

Juego de útiles para interiores universal, 12pzs



**BBS100**



€



35 x 355 x 585 mm

63,80

1 BBS20P12

Equipo reparador de plásticos



**BBS210**



€



100 x 280 x 360 mm  
22 x 64 x 106 mm  
22 x 64 x 106 mm  
22 x 64 x 106 mm  
22 x 64 x 106 mm  
22 x 64 x 106 mm  
22 x 64 x 106 mm  
22 x 64 x 106 mm  
22 x 64 x 106 mm

411,91  
24,73  
26,93  
29,96  
32,98  
24,73  
26,93  
32,24  
35,21

1 BBS210  
1 BBS210U06  
1 BBS210U08  
1 BBS210UA06  
1 BBS210UA08  
1 BBS210V06  
1 BBS210V08  
1 BBS210W06  
1 BBS210W08

Juego herramientas universal para extracción de Air bags, 12 PZs



**BBS100**



€



55 x 160 x 275 mm

77,66  
7,78  
13,73  
9,34  
21,47  
5,16  
2,25  
3,58  
3,45  
3,58  
3,45  
3,45

1 BBS100  
1 BBS10001  
1 BBS10002  
1 BBS10003  
1 BBS10004  
1 BBS10005  
1 BBS100057  
1 BBS10006  
1 BBS10007  
1 BBS10008  
1 BBS10009  
1 BBS10010

Juego de 4 espátulas



**2220**



€



125 g

19,85

1 22209004B

Remachadora para tuercas M3-M6



**1468-M6**



€



20 x 110 x 265 mm

105,29

1 1468-M6

Juego: 1468-M6

Remachadora para tuercas M4-M10



**1468-M10**



€



50 x 210 x 575 mm

264,48

6 1468-M10

Insertos para remachadora para tuercas 1468-M6



**1468-6M**



€



15 x 15 x 50 mm  
13 x 13 x 50 mm  
25 x 25 x 55 mm  
20 x 20 x 55 mm

5,17  
5,17  
5,17  
5,17

1 1468-6M3  
1 1468-6M4  
1 1468-6M5  
1 1468-6M6

Insertos para remachadora para tuercas 1468-M10



**1468-10M**



€



17 x 17 x 90 mm  
17 x 17 x 90 mm  
20 x 20 x 90 mm  
20 x 20 x 85 mm  
20 x 20 x 85 mm

20,24  
20,24  
20,24  
20,24  
20,24

1 1468-10M4  
1 1468-10M5  
1 1468-10M6  
1 1468-10M8  
1 1468-10M10





Juego portátil para carroceros



**BH8PR**

Icono de caja	kg	€	Icono de caja	Icono de pez
220 x 480 x 1030 mm	31 kg	<b>409,13</b>	1	BH8PR10000
168 x 345 x 575 mm	18.65 kg	<b>272,86</b>	1	BH8PR4000

Abrazadera para carroceros



**BH8BC1**

Icono de caja	€	Icono de caja	Icono de pez
45 x 135 x 230 mm	<b>118,55</b>	1	BH8BC1

Abrazadera para carroceros



**BH8BC2**

Icono de caja	€	Icono de caja	Icono de pez
51 x 150 x 220 mm	<b>141,69</b>	1	BH8BC2

Abrazadera para carroceros



**BH8BC3**

Icono de caja	€	Icono de caja	Icono de pez
90 x 65 x 240 mm	<b>112,02</b>	10	BH8BC3

Abrazadera para carroceros



**BH8BC4**

Icono de caja	€	Icono de caja	Icono de pez
80 x 120 x 175 mm	<b>240,83</b>	6	BH8BC4

Abrazadera para carroceros



**BH8BC5**

Icono de caja	€	Icono de caja	Icono de pez
45 x 155 x 230 mm	<b>166,37</b>	6	BH8BC5

**EQUIPOS DE ELEVACIÓN**

Gatos hidráulicos de botella Premium



**BH4B**

Icono de gato	Icono de caja	€	Icono de caja	Icono de pez
2000 kg	195 x 115 x 135 mm	<b>67,00</b>	10	BH4B2
5000 kg	220 x 115 x 155 mm	<b>80,00</b>	6	BH4B5
8000 kg	220 x 120 x 175 mm	<b>122,00</b>	4	BH4B8
12000 kg	260 x 145 x 200 mm	<b>150,00</b>	2	BH4B12
20000 kg	290 x 180 x 230 mm	<b>167,80</b>	2	BH4B20
30000 kg	335 x 160 x 240 mm	<b>220,00</b>	1	BH4B30

Gatos hidráulicos de botella



**BH4G**

Icono de gato	Icono de caja	€	Icono de caja	Icono de pez
2000 kg	200 x 105 x 105 mm	<b>31,00</b>	6	BH4G2
4000 kg	215 x 110 x 125 mm	<b>40,00</b>	6	BH4G4
6000 kg	230 x 120 x 130 mm	<b>50,00</b>	4	BH4G6
8000 kg	245 x 130 x 140 mm	<b>59,00</b>	4	BH4G8
12000 kg	240 x 140 x 150 mm	<b>75,00</b>	4	BH4G12
20000 kg	245 x 155 x 175 mm	<b>105,00</b>	2	BH4G20
50000 kg	290 x 200 x 225 mm	<b>260,00</b>	1	BH4G50

Gato de botella hidráulico-neumático



**BH4HP50**

		€		
50000 kg	300 x 210 x 310 mm	735,20	1	BH4HP50

Gato de aluminio 1,5T



**BH1A1500A**

		€		
1500 kg	170 x 370 x 660 mm	379,85	1	BH1A1500A

Gato de aluminio 2,5T



**BH1A2500A**

		€		
2500 kg	205 x 385 x 800 mm	582,03	1	BH1A2500A

Gato con doble pistón 3Tn



**BH1EU3000**

		€		
3000 kg	1400 x 340 x 617 mm	262,60	1	BH1EU3000

Gato extra bajo 1,5 Tn



**BH11500**

		€		
1500 kg	1270 x 364 x 945 mm	596,84	1	BH11500

Gato de carretilla extra bajo 2 Tn



**BH12000**

		€		
2000 kg	1270 x 364 x 780 mm	530,53	1	BH12000

Gato compacto 3 Tn



**BH13000**

		€		
3000 kg	1280 x 364 x 825 mm	408,51	1	BH13000

Gato con aproximación rápida 3Tn



**BH13000QA**

		€		
3000 kg	220 x 395 x 900 mm	600,45	1	BH13000QA



Travesa para gato de carretilla 1Tn



**BH1CB1000**

		€		
1000 kg	145 x 125 x 710 mm	<b>184,38</b>	1	BH1CB1000

Compatible con BH1M1000, BH11500, BH1200 y BH13000

Gato largo alta elevación 3Tn



**BH13000L**

		€		
3000 kg	1310 x 530 x 1370 mm	<b>1.286,52</b>	1	BH13000L

Gato Hidráulico 5T



**BH15000B**

		€		
5000 kg	330 x 520 x 1670 mm	<b>1.087,42</b>	1	BH15000B

Gato Hidráulico 10T



**BH110000B**

		€		
10000 kg	270 x 520 x 1670 mm	<b>1.628,48</b>	1	BH110000B

Extensiones de 120mm para gatos BH15000A y BH110000A



**BH15000A-EXT/BH110000A-EXT**

	€		
151 mm	<b>142,89</b>	1	BH110000A-EXT*

Gato tijera 4-5Tn



**BH1S45**

		€		
4000 kg	1194 x 212 x 680 mm	<b>745,00</b>	1	BH1S45

Pedal goma repuesto



**BH1RS**

	€		
BH1EU3000	<b>7,01</b>	1	BH1EU3000-03
BH11500, BH12000, BH13000, BH13000QA, BH13000L, BH1M1000, BH1A2500A	<b>6,83</b>	1	BH11500-04
BH15000A	<b>4,76</b>	1	BH15000A-04
BH110000A	<b>12,60</b>	1	BH110000A-04

Ruedas delanteras de repuesto



**BH1\_FW**

	€		
BH1A2500	<b>80,18</b>	1	BH1A2500-03
BH13000	<b>23,25</b>	1	BH13000-02
BH1EU3000	<b>14,05</b>	1	BH1EU3000-01
BH1M1000, BH11500, BH12000	<b>18,26</b>	1	BH11500-02
BH1S45	<b>11,23</b>	1	BH1S45-03
BH15000A	<b>59,55</b>	1	BH15000A-02
BH110000A	<b>108,13</b>	1	BH110000A-02

Gato neumático 2 niveles



**BH9BJ22SSH**

		€		
2000 kg	345 x 265 x 265 mm	<b>755,99</b>	1	BH9BJ22SSH

Gato neumático de 2 niveles



**BH9BJ22**

		€		
2000 kg	1000 x 265 x 265 mm	<b>775,85</b>	1	BH9BJ22SLH

Incluida extensión de 60mm. BH9BJ22SLH tiene mango L, BH9BJ22SSH tiene mango S

Gato Neumatico 3 Niveles



**BH9BJ23SSH**

		€		
2000 kg	490 x 250 x 250 mm	<b>1.021,97</b>	1	BH9BJ23SSH

Gato neumático 3 niveles



**BH9BJ23**

		€		
2000 kg	1000 x 250 x 250 mm	<b>1.041,86</b>	1	BH9BJ23SLH

Incluida extensión de 60mm, BH9BJ23SLH tiene mango L, BH9BJ23SSH tiene mango S

Extensión de acero para gatos neumáticos



**BH9BJ260\_80**

	€		
970 g	<b>36,92</b>	1	BH9BJ260
1180 g	<b>42,82</b>	1	BH9BJ280

Gato oleoneumático 30Tn



**BH230**

		€		
360 mm	627 mm	<b>3.448,43</b>	1	BH230

Gato oleoneumático compacto 30/15 Tn



**BH23015C**

		€		
30000 kg	1350 x 290 x 430 mm	<b>1.724,21</b>	1	BH23015C

Gato oleoneumático 30 / 15 T



**BH23015**

		€		
30000 kg	1250 x 282 x 810 mm	<b>2.765,81</b>	1	BH23015

Gato oleoneumático 40/20/10 Tn



**BH2402010**

		€		
40000 kg	1225 x 302 x 825 mm	<b>2.374,11</b>	1	BH2402010

Gato oleoneumático 60/40/20 t



**BH2604020**

		€		
60000 kg	1250 x 295 x 875 mm	<b>3.249,47</b>	1	BH2604020

\* Hasta agotar existencias



Gato hidráulico-neumático 80/50T



**BH28050**

		€		
80000 kg	380 x 470 x 1200 mm	<b>3.855,64</b>	1	BH28050

Pareja de caballetes



**BH33000/BH36000**

	€		
3000 kg	<b>66,84</b>	1	BH33000
6000 kg	<b>131,45</b>	1	BH36000

Caballete para vehículo industrial



**BH3HD8000**

	€		
8000 kg	<b>75,00</b>	2	BH3HD8000

Perno de seguridad (BH3HD1200) equipado con un sistema de tirador

Plato universal para gatos oleoneumáticos

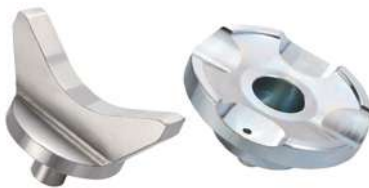

**BH2AC60**

		€		
78 x 70 x 110 mm	0.97 kg	<b>420,80</b>	1	BH2AC60V110*

Pareja de caballetes automáticos



**BH3A**

	€		
3000 kg	<b>111,39</b>	1	BH3A3000
5000 kg	<b>167,10</b>	1	BH3A5000
10000 kg	<b>298,02</b>	1	BH3A10000

Caballete para vehículos 12T 1P



**BH3HD12000**

	€		
12000 kg	<b>145,00</b>	1	BH3HD12000

Par de caballetes ligeros aluminio 2,5Tn



**BH3AL2500**

	€		
2500 kg	<b>156,51</b>	1	BH3AL2500*

Caballete de base cuadrada



**BH3SQ**

	€		
7000 kg	<b>92,00</b>	2	BH3SQ7000
15000 kg	<b>185,00</b>	2	BH3SQ15000

Caballete para vehículos 16T 1P



**BH3HD16000**

	€		
16000 kg	<b>155,00</b>	1	BH3HD16000



Caballete 20T para tareas pesadas



**BH3HD20000A**

	€		
20000 kg	270,00	1	BH3HD20000A

Cabeza giroscópica para gatos de foso



**BH5US1000**

		€		
250 x 340 x 420 mm	260-510 mm	243,51	1	BH5US1000

Gato hidráulico sacarruedas para camión



**BH8AC3-600**

		€		
1030 x 1050 x 1020 mm	93.5 kg	1.002,55	1	BH8AC3-600

Gato de foso doble pistón 500Kg



**BH5SP500QA**

		€		
500 kg	2041 x 660 x 660 mm	514,08	1	BH5SP500QA

Carretilla transportadora



**BH1CD680**

		€		
16.22 kg	610 x 240 x 220 mm	204,25	1	BH1CD680

Plataforma rodante, 1,5 T



**BH8AC3-1500A**

		€		
310 x 1070 x 1345 mm	132 kg	1.936,14	1	BH8AC3-1500A

Gato de foso doble pistón 1000 Kg



**BH5DP1000QA**

		€		
1000 kg	1954 x 759 x 759 mm	953,63	1	BH5DP1000QA

Soporte para carretillas transportadoras



**BH1CD680ST**

		€		
715 x 130 x 155 mm	135 kg	100,26	1	BH1CD680ST

Grúa plegable 600Kg



**BH6PC600**

		€		
2315 x 1040 x 1480 mm	96 kg	1.034,52	1	BH6PC600

\* Hasta agotar existencias



### Grúa plegable 1Tn



#### BH6FC1000

		€		
2175 x 1030 x 1480 mm	85 kg	<b>857,74</b>	1	BH6FC1000

### Bote de aceite de repuesto hidráulico ISO VG15 de 250 ml



#### BHVG15-250

		€		
160 x 60 x 60 mm	220 g	<b>10,18</b>	1	BHVG15-250

### Grúa plegable 2Tn



#### BH6FC2000

		€		
2640 x 1220 x 1845 mm	170 kg	<b>1.379,37</b>	1	BH6FC2000

Altura entrada mínima: 130mm Altura máx de gancho: 2.640mm

### Ruedas traseras de repuesto



#### BH1 RW

	€		
BH1A1500	<b>34,58</b>	1	BH1A1500-04
BH1A2500	<b>61,10</b>	1	BH1A2500-04
BH1M1000,BH11500,BH12000, BH13000	<b>25,95</b>	1	BH11500-01
BH1EU3000	<b>24,86</b>	1	BH1EU3000-08
BH13000L	<b>17,41</b>	1	BH13000L-01
BH1S45-01	<b>23,66</b>	1	BH1S45-01
BH15000A,BH110000A	<b>28,00</b>	1	BH15000A-01

### Barra soporte para motores



#### BH6AC1-680A

	€		
565 x 12 x 774 mm	<b>120,30</b>	1	BH6AC1-680A



## Equipos de iluminación



## LINTERNAS MANUALES

Lámpara-linterna con USB



### BLTS7P

	€		
45 lm	58,07	58	BLTS7P

IP 20

Lámpara-linterna compacta y ligera con Aluminio



### BLTFC1

	€		
180 lm	97,86	20	BLTFC1

IP 20 - Ángulo difusión 120° Batería Li-on

Lámpara-linterna ultra ligera con mini USB



### BLTS10

	€		
400 lm	63,86	20	BLTS10

## LINTERNAS PARA LA CABEZA

Lámpara de cabeza



### BFRL11

	€		
260 lm	62,60	1	BFRL11

Adaptador de control de velocidad para el enrollador cable



### BLCRSC

BLCR		€		
230PL,FR,SC 76 x 91 x 117 mm		97,63	1	BLCRSC1
24VCL,VLL 76 x 91 x 117 mm		97,63	1	BLCRSC2

## ENROLLADORES DE CABLE

Enrollador de cable para trabajos a 230V



### BLCR230

		€		
230 V	800/2000 W	262,57	1	BLCR230FR
230 V	800/2000 W	262,57	1	BLCR230SC

Adaptador de control de velocidad BLCRSC1 opcional

Enrollador de cable 400V



### BLCR400E

		€		
400 V	2800/5000 W	930,06	1	BLCR400E

15m IP24



## Herramientas de inspección





## ENDOSCOPIOS

Cables lente



### BE200C

∅	L	€		
25 mm	10 m	2.602,79	1	BE200CAB250SH10*
25 mm	25 m	3.602,63	1	BE200CAB250SH25
25 mm	3 m	1.735,22	1	BE200CAB250SH3*
4 mm	1 m	1.132,01	1	BE200CAB40F1*
5.5 mm	1 m	793,23	1	BE200CAB55F1*
5.5 mm	3 m	1.049,39	1	BE200CAB55F3*
5.8 mm	1 m	809,78	1	BE200CAB58SR1
5.8 mm	3 m	1.074,19	1	BE200CAB58SR3
8 mm	1 m	422,82	1	BE200CAB80SR1
8 mm	3 m	811,69	1	BE200CAB80SR3

Espejos y puntas magnéticas



### BE200M

∠°	L	€		
0°	5.5, 5.8	77,66	1	BE200MAG55
35°	5.5, 5.8	77,67	1	BE200MIR5535
45°	5.5, 5.8	77,67	1	BE200MIR5545
55°	5.5, 5.8	77,67	1	BE200MIR5555
35°	8	76,32	1	BE200MIR8035
45°	8	76,32	1	BE200MIR8045
55°	8	76,32	1	BE200MIR8055
35°	4	69,14	1	BE200MIR4035
55°	4	69,14	1	BE200MIR4055

## ESTETOSCOPIOS

Estetoscopio electrónico de mecánico



### BE220

L	kg	€		
130 x 370 x 340 mm	2.94 kg	249,63	1	BE220

Estetoscopio, sonda de acero



### 5050

L	€		
1050 mm	104,09	1	5050

## ESPEJOS

Espejo articulado



### 5515GV

L	∅	€		
215 mm	30 mm	36,79	1	5515GV

Espejo telescópico con cabeza giratoria



### 5515T-52

L	∅	€		
255-450 mm	52 mm	13,77	25	5515T-52

Espejo de inspección pivotante con LED y cable semirrígido aislado



### 5515FL

L	∅	€		
550 mm	62 x 38 mm	39,19	10	5515FL

Espejo de inspección pivotante con UV y cable semirrígido aislado



### 5515FUV

L	∅	€		
550 m	65x42 mm	52,07	1	5515FUV

Espejo de reparación en plástico



### 5515B

L	∅	€		
220 mm	28.5 mm	26,51	25	5515B

Espejo de reparación con mango metálico



**5515M**

		€		
210 mm	30 mm	36,66	1	5515M

Espejo telescópico de bolsillo



**5515T**

		€		
180-690 mm	30 mm	32,38	25	5515T

Espejo auxiliar



**5515L**

		€		
160 mm	21 mm	27,97	1	5515L

## LUPAS

Lupa óptica



**BOM10X**

	€		
180 mm	39,25	10	BOM10X

\* Hasta agotar existencias





**BAHCO®**



## Extractores



## MECÁNICO

### Extractor universal de dos garras



#### 4532

		€		
25-80 mm	100 mm	112,08	1	4532-A
25-80 mm	200 mm	120,50	1	4532-AL
25-130 mm	100 mm	117,10	1	4532-B
25-130 mm	200 mm	127,65	1	4532-BL
50-160 mm	150 mm	194,07	1	4532-C
50-160 mm	300 mm	214,27	1	4532-CL
60-200 mm	150 mm	200,74	1	4532-D
80-250 mm	200 mm	313,53	1	4532-E
80-350 mm	200 mm	347,94	1	4532-F
110-520 mm	200 mm	581,43	1	4532-G
110-520 mm	300 mm	673,00	1	4532-G-SO
170-640 mm	225 mm	1.064,37	1	4532-H

Cuerpo: 4532/B; Par de garras: 4532K; Par de garras largas: 4532LK; Husillo: 4532/S

### Brazos de repuesto para extractor 4532



#### 4532K-4532LK

		€		
4532-A, 4532-B	100 mm	60,65	1	4532K1
4532-C, 4532-D	150 mm	102,64	1	4532K2
4532-E, 4532-F, 4532-G	200 mm	170,39	1	4532K3
4532-H	225 mm	298,26	1	4532K4
4532-AL, 4532-BL	200 mm	81,98	1	4532LK1
4532-CL	300 mm	137,03	1	4532LK2
4532-G-SO	300 mm	229,71	1	4532LK3
4532-E, 4532-F, 4532-G, 4532-G-SO	400 mm	275,78	1	4532LK4
4532-E, 4532-F, 4532-G, 4532-G-SO	500 mm	288,79	1	4532LK5

### Husillo para extractor 4532



#### 4532-S

	€		
4532-O, 4532-A, 4532-AL, 4532-B, 4532-BL	27,14	1	4532-OAB/S
4532-C, 4532-CL, 4532-D	51,39	1	4532-CD/S
4532-E, 4532-F, 4532-G, 4532-G-SO	91,91	1	4532-EFG/S
4532-H	144,01	1	4532-H/S

### Extractor de garras estrechas



#### 4532-0

		€		
20-90 mm	100 mm	126,19	1	4532-0

Cuerpo: 4532-0/B; Par de garras: 4532K0; Husillo: 4532-OAB/S

### Extractor 2 brazos universal



#### 3115

		€		
80-250 mm	300 mm	368,36	1	3115

### Expositor de extractores de dos garras



#### 4532ST/5

	€		
16700 g	948,48	1	4532ST/5

4532-A, 4532-B, 4532-C, 4532-D, 4532-E

### Extractor de tres garras



#### 4533

		€		
150-700 mm	185 mm	2.793,05	1	4533HP
150-700 mm	200 mm	2.548,85	1	4533M
	185 mm	658,08	1	4533HPK
	200 mm	473,14	1	4533MK
		603,48	1	4533HP/S
		200,54	1	4533M/S

4533HP - Sistema hidráulico; 4533M - Mecánico 4533/K: Juego 3 garras; 4533/S: Husillo de repuesto

### Cilindro hidráulico



#### 4529

	Tn max	€		
8 to	60 N·m	228,67	1	4529-8
15 to	70 N·m	275,38	1	4529-15



Extractor: Hidráulico de 3 garras - Industria Pesada



**4528**

Extractor	Manija	€	Paquete	Imagen
50-350 mm	135 mm	<b>1.203,89</b>	1	4528-1

Juego 3 garras:4528K; Cuerpo: 4528/B; Husillo sist. hidráulico 4533HP/S

Extractor de 2 y 3 garras



**4544**

Extractor	Manija	€	Paquete	Imagen
10-100 mm	80 mm	<b>83,46</b>	1	4544-1
10-120 mm	120 mm	<b>132,10</b>	1	4544-2
20-160 mm	160 mm	<b>198,05</b>	1	4544-3
20-200 mm	200 mm	<b>270,30</b>	1	4544-4
		<b>20,10</b>	1	4544-110/S
		<b>39,60</b>	1	4544-220/S
		<b>63,36</b>	1	4519-1/S
		<b>48,13</b>	1	4544-440/S

2 garras: 4544-1/4; 3garras:4544-10/30; Cuerpo:4544/B Garra:4544K; Husillo:4544/S

Extractores de tres garras de uso en la industria pesada con acabado galvanizado



**4544-**

Extractor	Manija	€	Paquete	Imagen
10-100 mm	80 mm	<b>120,24</b>	1	4544-10
10-120 mm	120 mm	<b>179,72</b>	1	4544-20
20-160 mm	160 mm	<b>264,26</b>	1	4544-30

Extractor de 2 o 3 garras



**4543**

Extractor	Manija	€	Paquete	Imagen
10-60 mm	40 mm	<b>36,71</b>	1	4543-1
10-70 mm	74 mm	<b>38,77</b>	1	4543-2
10-90 mm	84 mm	<b>67,60</b>	1	4543-3
		<b>15,51</b>	1	4543-1/S
		<b>15,52</b>	1	4543-2/S
		<b>18,57</b>	1	4543-3/S

2 garras: 4543-1/3; 3garras 4543-10/30; Cuerpo:4543/B; Garra:4543K; Husillo:4543/S

Extractores de tres garras de uso ligero con acabado galvanizado



**4543-**

Extractor	Manija	€	Paquete	Imagen
10-60 mm	40 mm	<b>50,80</b>	1	4543-10
10-70 mm	74 mm	<b>54,91</b>	1	4543-20
10-90 mm	84 mm	<b>77,74</b>	1	4543-30

Extractor de dos garras



**4541**

Extractor	Manija	€	Paquete	Imagen
20-150 mm	85 mm	<b>113,17</b>	1	4541-A
40-220 mm	130 mm	<b>189,95</b>	1	4541-B

Cuerpo: 4541/B; Garra: 4541K; Husillo A:4532-03B/S y Husillo B:4519-1/S 4532-4519/S: Husillo de repuesto

Extractor de 3 garras



**4542**

Extractor	Manija	€	Paquete	Imagen
20-150 mm	85 mm	<b>146,33</b>	1	4542-A
40-220 mm	130 mm	<b>241,91</b>	1	4542-B

Cuerpo: 4542/B; Garra: 4541K; Husillo A:4532-03B/S y Husillo B:4519-1/S 4532-4519/S: Husillo de repuesto

Extractor: 2 garras - Industria Pesada



**4537**

Extractor	Manija	€	Paquete	Imagen
20-170 mm	130 mm	<b>100,99</b>	1	4537-1
20-230 mm	200 mm	<b>180,70</b>	1	4537-2
50-300 mm	250 mm	<b>261,42</b>	1	4537-3
50-350 mm	350 mm	<b>308,01</b>	1	4537-4

Cuerpo: 4537/B; Garra: 4537K; Husillo 1: 4532-03B/S, husillo 2: 4519-1/S, husillo 3 y 4: 4519-2/S 4532-4519/S: Husillo de repuesto

Extractor de 3 garras - Industria Pesada



**4528M**

Extractor	Manija	€	Paquete	Imagen
20-170 mm	130 mm	<b>127,68</b>	1	4528M1
20-230 mm	200 mm	<b>227,28</b>	1	4528M2
50-300 mm	250 mm	<b>338,69</b>	1	4528M3
50-350 mm	350 mm	<b>408,99</b>	1	4528M4
50-400 mm	400 mm	<b>419,44</b>	1	4528M5

Cuerpo:4528M/B; Garra:4537K-4528MK; Husillo 1: 4532-03B/S, husillo 2: 4519-1/S, husillo 3, 4 y 5: 4519-2/S Husillo 4532/S-4519/S



Extractor con abrazadera



**4519**

Icono 1	Icono 2	€	Icono 3	Icono 4
20-110 mm	80-170 mm	<b>278,46</b>	1	4519-1
40-150 mm	90-270 mm	<b>365,62</b>	1	4519-2
40-150 mm	90-330 mm	<b>417,21</b>	1	4519-3

Cuerpo: 4519/B; Garra: 4519K; Husillo: 4519/S

Extractor tipo tijera



**4614**

Icono 1	Icono 2	€	Icono 3	Icono 4
6-100 mm	70-85 mm	<b>159,52</b>	1	4614-1
10-140 mm	85-120 mm	<b>194,95</b>	1	4614-2

Cuerpo: 4614/B; Par de garras: 4614K; Husillo 4543-4532/S

Extractores múltiples



**4540**

Icono 1	Icono 2	€	Icono 3	Icono 4
30-170 mm	65-140 mm	<b>266,38</b>	1	4540-17
		<b>40,69</b>	1	4540-17/S
75-250 mm	77-180 mm	<b>393,71</b>	1	4540-25
		<b>50,83</b>	1	4540-25/S

Extractor para separador de guillotina



**4552**

Icono 1	€	Icono 2	Icono 3
4551-A-B	<b>147,25</b>	1	4552-1
4551-C	<b>212,76</b>	1	4552-2
4551-D	<b>328,21</b>	1	4552-3

Cuerpo: 4552/B; Garra: 4552K Husillo: 4532/S

Separador de guillotina



**4551**

Icono 1	€	Icono 2	Icono 3
4552-1	<b>93,03</b>	1	4551-A
4552-1	<b>118,17</b>	1	4551-B
4552-2	<b>192,68</b>	1	4551-C
4552-3	<b>301,21</b>	1	4551-D

4551A:10-60mm; 4551B:15-75mm 4551C:35-115mm; 4551D:40-150mm

Juego de extractores y separadores



**4574**

Icono 1	€	Icono 2	Icono 3
105 x 300 x 360 mm	<b>1.187,90</b>	1	4574

4532-A, 4532-C

4532LK1, 4532LK2

4551-C

4529-15

Extractor de rodamientos sin garras



**4581N-4583N**

Icono 1	€	Icono 2	Icono 3
4581NA, 4581NB	<b>63,93</b>	1	4581N-1
4581NB2, 4581NC, 4582NA	<b>63,93</b>	1	4582N-1
4581NC, 4582NA, 4582NB	<b>80,14</b>	1	4582N-2
4582NA, 4583NA	<b>100,99</b>	1	4583N-1
4582NA, 4582NB, 4583NB	<b>120,76</b>	1	4583N-2

Garras de repuesto - juego de 4 pzs



**4581NA-4583NB**

Icono 1	Icono 2	€	Icono 3	Icono 4
145 mm	4581N-1	<b>84,88</b>	1	4581NA
120 mm	4581N-1	<b>91,42</b>	1	4581NB
130 mm	4582N-1	<b>97,80</b>	1	4581NB2
130 mm	4582N-1, 4582N-2	<b>98,03</b>	1	4581NC
150 mm	4582N-1, 4582N-2, 4583N-1, 4583N-2	<b>104,78</b>	1	4582NA
150 mm	4582N-2, 4583N-2	<b>109,34</b>	1	4582NB
190 mm	4583N-1	<b>167,22</b>	1	4583NA
235 mm	4583N-2	<b>274,13</b>	1	4583NB

Juego de extractores de rodamientos de bolas



**4580N/7**

Icono 1	€	Icono 2	Icono 3
66 x 192 x 287 mm	<b>1.573,09</b>	1	4580N/7

4581N-1, 4582N-1, 4582N-2, 4583N-1, 4583N-2, 4581NA to 4583NB

Juego extractores de rodamientos



**4578**

	€		
75 x 235 x 285 mm	<b>615,67</b>	1	4578

4 jgos garras 4 pzs cada: 4581NA y 4581NB para 4581N-1; 4581NB2 y 4581NC para 4852N1 NB2-NC

Extractor interior para rodamientos



**4521N**

	€		
5-7 mm	<b>77,90</b>	1	4521N-00
7-9 mm	<b>77,89</b>	1	4521N-0
9-12 mm	<b>74,24</b>	1	4521N-A
10-13 mm	<b>74,24</b>	1	4521N-B
13-17 mm	<b>76,54</b>	1	4521N-C
14-19 mm	<b>76,54</b>	1	4521N-D
16-21 mm	<b>76,54</b>	1	4521N-E
18-23 mm	<b>87,06</b>	1	4521N-F
20-25 mm	<b>87,06</b>	1	4521N-G
25-30 mm	<b>89,56</b>	1	4521N-H
30-37 mm	<b>99,45</b>	1	4521N-I
35-42 mm	<b>122,54</b>	1	4521N-K
38-45 mm	<b>122,54</b>	1	4521N-L
43-50 mm	<b>152,88</b>	1	4521N-M
40-75 mm	<b>366,69</b>	1	4521N-S
70-115 mm	<b>437,52</b>	1	4521N-T

Extractor 2 garras con acabado galvanizado



**4522**

	€		
35-75 mm	<b>66,50</b>	1	4522-1
60-130 mm	<b>105,08</b>	1	4522-2

Cuerpo:4522/B; Garra:4522/K; Husillo:4522/S 4522/S; Husillo de repuesto

Barra de impacto para cabezas 400 gr



**4523G**

	€		
Ø10x170 mm	<b>78,73</b>	1	4523G

Para 4521N-OO/E

Barra de impacto para cabezas 1.3 kg



**4524G**

	€		
Ø16 x 250 mm	<b>111,87</b>	1	4524G

Para 4521N-F & 4521N-M

Juego de extractores de rodamientos



**4521N/7**

		€		
95 x 360 x 310 mm	6800 g	<b>1.232,44</b>	1	4521N/7

4521N-B, 4521N-D, 4521N-H, 4521N-I, 4521N-L, 4521N-S, 4521N-G

4522-2, 4522-1

Extractor universal de rótulas



**4545-N**

		€		
Max 50 mm	18-22 mm	<b>123,40</b>	1	4545-N1
Max 90 mm	27-36 mm	<b>289,89</b>	1	4545-N11
Max 50 mm	26 mm	<b>169,56</b>	1	4545-N2
60-80 mm	26 mm	<b>212,33</b>	1	4545-N21

Husillo: 4545/S

Extractor de cubos de ruedas



**4518**

		€		
225 mm	140 mm	<b>262,08</b>	1	4518-3
225 mm	140 mm	<b>320,22</b>	1	4518-4
225 mm	140 mm	<b>331,13</b>	1	4518-5



Extractor de rótulas



**4545**

	€		
18 mm	60,34	1	4545-1
25 mm	82,03	1	4545-2
29 mm	106,66	1	4545-3
40 mm	140,39	1	4545-4
45 mm	171,48	1	4545-5

Juego de extractores para mantenimiento de vehículos



**4577**

	€		
70 x 340 x 425 mm	1.527,19	1	4577

4545-N2	
4532-B	
4614-1	
4521N-D, 4521N-B, 4521N-H, 4521N-I, 4521N-G, 4521N-L	
4522-1	

Juego extractores interiores y exteriores



**4590SHS5**

	€		
79 x 230 x 500 mm	206,62	4	4590SHS5

Juego extractores mini



**4579**

	€		
65 x 210 x 275 mm	244,93	1	4579

Extractores 2 garras: 4543-2, 4543-3; Cuerpos: 4543-1020/B, 4543-30/B; Garras: 4543K220, 4543K330

Tronzatuercas hidráulico



**4610**

	€		
M4-M14	243,56	1	4610-1

Tronzatuercas mecánico



**4611**

	€		
to M16	81,48	1	4611-2
to M24	159,61	1	4611-3

4611-2 Hoja: 4611-2/B; Husillo: 4611-2/S

Extractor de espárragos



**4553**

	€		
5-20 mm	66,24	1	4553

Grosor de cabeza: 10mm

Extractor de espárragos



**4591-4593**

	€		
10-19 mm	78,39	1	4592
5-15 mm	67,23	1	4591
18-28 mm	96,16	1	4593



Extractor de espárrago



**1420-1424**

	€		
M 3-6	3,47	1	1420-1.4
M 6-8	4,10	1	1421-2.1
M 8-11	5,72	1	1422-3.1
M11-14	7,02	1	1423-4.8
M14-18	8,42	1	1424-6.2

Juego de 5 extractores de espárragos



**1435/5**

	g	€	
15 x 50 x 90 mm	110 g	29,16	1 1435/5

1423-4.8, 1420-1.4, 1422-3.1, 1421-2.1, 1424-6.2

Juego de 8 extractores de espárragos



**1435/8**

	g	€	
29 x 110 x 118 mm	700 g	92,13	1 1435/8

M18-24 + M24-33 + M33-45

1420-1.4, 1421-2.1, 1422-3.1, 1423-4.8, 1424-6.2

Extractores para tornillos rotos



**1419-M5/1419-M16**

	€		
M5-M10	29,42	1	1419-M5
M8-M14	32,92	1	1419-M8
M12-M20	37,14	1	1419-M12
M16-M24	47,15	1	1419-M16

Juego de 4 extractores de espárragos para tornillos rotos



**1419/4**

	g	€	
M5-M24	430 g	133,83	1 1419/4

M5-M10; M8-M14; M12-M20; M16-M24

Juego 15 extractores de espárragos



**BWMSP15**

	kg	€	
43 x 90 x 200 mm	0.54 kg	106,56	1 BWMSP15

Puntas extractoras de espárragos



**BWMSP15**

		€	
3 mm	13 mm	5,27	1 BWMSP1501
4 mm	13 mm	5,27	1 BWMSP1502
5 mm	13 mm	5,27	1 BWMSP1503
5.5 mm	13 mm	5,27	1 BWMSP1504
6 mm	13 mm	5,27	1 BWMSP1505
8 mm	13 mm	5,27	1 BWMSP1506
10 mm	13 mm	5,27	1 BWMSP1507
1/8 in	13 mm	5,27	1 BWMSP1508
3/16 in	13 mm	5,27	1 BWMSP1509
1/4 in	13 mm	5,27	1 BWMSP1510
3/8 in	13 mm	5,27	1 BWMSP1511
11 mm	16 mm	5,75	1 BWMSP1512
12 mm	16 mm	5,75	1 BWMSP1513
14 mm	16 mm	5,75	1 BWMSP1514
1/2 in	16 mm	5,75	1 BWMSP1515

Juego de extractores de espárrago



**1418S**

		€	
25 x 127 x 162 mm	M6-M16	179,00	1 1418S

1418-4, 1418-5, 1418-6, 1418-7.5, 1418-8.5





### Extractores de espárrago



#### 1418

	€		
M5-M8	11,98	1	1418-4
M8-M10	14,18	1	1418-5
D11-M12	15,93	1	1418-6
M12-M14	18,14	1	1418-7.5
M14-M16	21,12	1	1418-8.5

### Palanca especial



#### 3680

L	€		
400 mm	66,26	1	3680

### Palanca, varilla pasante



#### 2484T-20/2484T-60

L	€		
210 mm	13,60	1	2484T-20
312 mm	19,43	1	2484T-30
450 mm	26,53	1	2484T-45
600 mm	31,36	1	2484T-60

## PALANCAS

### Extractor de clavos



#### 2632

L	€		
170 mm	23,72	1	2632

### Elevador con mango plástico



#### 2484-20/2484-60

L	€		
205 mm	10,16	1	2484-20
305 mm	13,06	1	2484-30
465 mm	20,30	1	2484-45
615 mm	24,66	1	2484-60

### Juego de palancas, varilla pasante



#### 2484T/S4

Dimensions	g	€	
42 x 145 x 693 mm	1950 g	81,85	1 2484T/S4

### Palanca



#### 3684

L	€		
406 mm	25,27	1	3684-16
457 mm	34,72	1	3684-18
609 mm	45,06	1	3684-24
760 mm	75,73	1	3684-30

### Juego de 4 palancas



#### 2484/S4

Dimensions	€		
42 x 145 x 693 mm	50,78	10	2484/S4

### Palanca



#### 3683

L	€		
400 mm	54,87	1	3683

2484-20, 2484-30, 2484-45, 2484-60

Palanca polivalente



**3681**

L	€	Icon 1	Icon 2
304 mm	32,88	1	3681-11
406 mm	39,47	1	3681-16
503 mm	49,33	1	3681-20

**HERRAMIENTAS PARA RECOGIDA**

Dedo magnético ERGO™

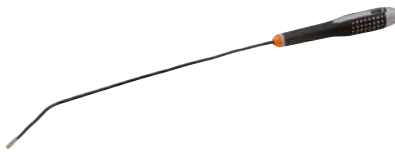

**2535F0**

Ø	L	€	Icon 1	Icon 2
5.5 mm	515 mm	18,41	1	2535F0

Dedo magnético flexible



**B147**

Ø	L	€	Icon 1	Icon 2
13 mm	400 mm	29,14	1	B147.001.400
19 mm	400 mm	31,91	1	B147.003.400

SB: Presentación en clip

Dedo magnético flexible



**2535F**

Ø	L	€	Icon 1	Icon 2
10 mm	400 mm	40,57	1	2535F1
10 mm	400 mm	36,76	1	2535F2
17 mm	400 mm	66,59	1	2535F3

2535F2: Mango pequeño

Recogedora magnética con luz



**2535L**

Ø	L	€	Icon 1	Icon 2
20 mm	40-670 mm	28,11	12	2535L

Dedo flexible con garras



**2509**

L	€	Icon 1	Icon 2
555 mm	79,63	50	2509

Dedo flexible con garras



**2530**

L	€	Icon 1	Icon 2
605 mm	6,85	1	2530

**HERRAMIENTAS PARA ROSCAS**

Juego de herramientas



**1460M/1**

Icon 1	Icon 2	€	Icon 3	Icon 4
53 x 407 x 220 mm	M5-M12	2.620,60	1	1460M/1

Juego de herramientas



**1460M/2**

Icon 1	Icon 2	€	Icon 3	Icon 4
53 x 407 x 220 mm	M5-M20	4.470,63	1	1460M/2

Juego de herramientas



**1460Z/2**

Icon 1	Icon 2	€	Icon 3	Icon 4
53 x 407 x 220 mm	1/4-3/4	6.646,83	1	1460Z/2



Giramachos de carraca reversible



**600**

	€		
3-10 mm		1	600.003.010
5-12 mm		1	600.005.012

Lima doble para roscas interiores y exteriores, pulgadas



**1450D-WW**

	€		
230 mm	94,08	1	1450D-WW

Lima doble para roscas interiores y exteriores,mm



**1450D-ISO**

	€		
230 mm	94,08	1	1450D-ISO

Paso Rosca 5-27

Juego de limas dobles



**1450D/2**

		€		
40 x 70 x 270 mm	M5-M27	179,81	1	1450D/2

1450D-ISO

1450D-WW



# Almacenamiento de herramientas y composiciones

# CARROS DE HERRAMIENTAS

Composiciones de herramientas de mantenimiento general en carro, 53", 488 piezas



**XXL**

986 x 501 x 1430 mm    € 8.195,45    1 XXL

1476KXXL7BK		
2058-BR, 6954, 6963, 7757, 7764, K6650-1/4-1P		
6700SM-10, 6700SM-11, 6700SM-12, 6700SM-13, 6700SM-14, 6700SM-4, 6700SM-4.5, 6700SM-5, 6700SM-5.5, 6700SM-6, 6700SM-7, 6700SM-8, 6700SM-9		
6700TORX-E10, 6700TORX-E4, 6700TORX-E5, 6700TORX-E6, 6700TORX-E7, 6700TORX-E8		
6950SL		
6956		
6960, 6962, 6962L, 696EX-11		
6966		
6972H		
7400SM-10, 7400SM-11, 7400SM-12, 7400SM-13, 7400SM-14, 7400SM-15, 7400SM-16, 7400SM-17, 7400SM-18, 7400SM-19, 7400SM-20, 7400SM-21, 7400SM-22, 7400SM-6, 7400SM-7, 7400SM-8, 7400SM-9		
7400TORX-E10, 7400TORX-E11, 7400TORX-E12, 7400TORX-E14, 7400TORX-E16, 7400TORX-E18, 7400TORX-E8		
7406ZZ-16, 7406ZZ-21		
7409BH-10, 7409BH-4, 7409BH-5, 7409BH-6, 7409BH-8		
7409F-10, 7409F-6.5, 7409F-8		
7409TORX-R-T27, 7409TORX-R-T30, 7409TORX-R-T40, 7409TORX-R-T45, 7409TORX-R-T50		
7409TORX-T25, 7409TORX-T27, 7409TORX-T30, 7409TORX-T40, 7409TORX-T45, 7409TORX-T50		
7750SL		
7758		
7759		
7760		

7761-W		
7765		
7766		
7767		
776EX-11		
7800SM-10, 7800SM-11, 7800SM-12, 7800SM-13, 7800SM-14, 7800SM-15, 7800SM-16, 7800SM-17, 7800SM-18, 7800SM-19, 7800SM-20, 7800SM-21, 7800SM-22, 7800SM-23, 7800SM-24, 7800SM-25, 7800SM-26, 7800SM-27, 7800SM-28, 7800SM-29, 7800SM-30, 7800SM-32, 7800SM-33, 7800SM-34, 7800SM-36, 7800SM-8, 7800SM-9		
7800TORX-E10, 7800TORX-E11, 7800TORX-E12, 7800TORX-E14, 7800TORX-E16, 7800TORX-E18, 7800TORX-E20, 7800TORX-E24, 7800TORX-E8		
7805SM-10, 7805SM-12, 7805SM-13, 7805SM-14, 7805SM-15, 7805SM-16, 7805SM-17, 7805SM-18, 7805SM-19, 7805SM-20, 7805SM-21, 7805SM-22, 7805SM-23, 7805SM-24, 7805SM-25, 7805SM-26, 7805SM-27, 7805SM-28, 7805SM-29, 7805SM-30, 7805SM-32		
7809M-10, 7809M-12, 7809M-14, 7809M-4, 7809M-5, 7809M-6, 7809M-7, 7809M-8		
7809M-10-140, 7809M-5-100, 7809M-6-100, 7809M-7-100, 7809M-8-120		
7809XZN-10, 7809XZN-10-100, 7809XZN-12, 7809XZN-12-100, 7809XZN-14, 7809XZN-14-100, 7809XZN-16, 7809XZN-18, 7809XZN-6, 7809XZN-8, 7809XZN-8-100		
8150SL		
8160-3, 8160-5		
8160W-10		
8164-1/2		
8171		
8166		
8167		
A6800DM-10, A6800DM-11, A6800DM-12, A6800DM-13, A6800DM-14, A6800DM-4, A6800DM-5, A6800DM-5.5, A6800DM-6, A6800DM-7, A6800DM-8, A6800DM-9		
A7402DM-10, A7402DM-11, A7402DM-12, A7402DM-13, A7402DM-14, A7402DM-15, A7402DM-16, A7402DM-17, A7402DM-18, A7402DM-19, A7402DM-21, A7402DM-7, A7402DM-8, A7402DM-9		
K6625-1/4-1P		
K6650-1/2-1P, K6650-3/8-1P		
2101G-160		
2421 G-140IP, 2421 G-180		
2427 G-200		
2430 G-160		
2628 G-180		
2800-140, 2800-180, 2800-225		
2890-125, 2890-180, 2890-210		
2900-140, 2900-180, 2900-215		
2951-250		
2952-165		
2990-140, 2990-180, 2990-200		
3416 A		
4130		
7224		
BE256-155, BE256-178, BE256-250		

BLTS7P		
CR W 01		
1150-1/2H/P		
1544		
2633/S4x 4		
59/S100BCx 100		
806-1-3		
808050L		
BE-7607		
BE-8020L		
BE-8155TB, BE-8256TB, BE-8258TB		
BE-8355		
BE-8600		
BE-8602		
BE-8610TB, BE-8620TB, BE-8623TB, BE-8624TB		
BE-8802		
BE-8810TB, BE-8820TB, BE-8823TB, BE-8824TB		
BE-8907, BE-8908, BE-8909, BE-8910, BE-8915, BE-8920, BE-8925, BE-8927, BE-8930, BE-8940		
BE-8986		
BE-9770x 9		
BE-9785x 13		
MTC-5-16-C1		
1-170-08-2-2		
1-210-08-2-2		
1-230-08-2-2		
208		
2484T-30, 2484T-60		
2509		
2535L		
319		
3625N-32		
3681-16		
3734-2, 3734-3, 3734-4, 3734-5, 3734-6, 3734-8		
3735-4-120, 3735-5-120		
3740-150, 3740-250		
3906-300-32-5Px 5		
479-08		
481-1000, 481-400		
5515T		
782-U		
KBGU-5P-DISPENx 5		
KERU-01		
111M-10, 111M-11, 111M-12, 111M-13, 111M-14, 111M-15, 111M-16, 111M-17, 111M-18, 111M-19, 111M-20, 111M-21, 111M-22, 111M-23, 111M-24, 111M-25, 111M-26, 111M-27, 111M-28, 111M-29, 111M-30, 111M-32, 111M-33, 111M-34, 111M-36, 111M-6, 111M-7, 111M-8, 111M-9		
1RM-10, 1RM-11, 1RM-12, 1RM-13, 1RM-14, 1RM-15, 1RM-16, 1RM-17, 1RM-18, 1RM-19, 1RM-21, 1RM-22, 1RM-24, 1RM-27, 1RM-30, 1RM-32, 1RM-6, 1RM-7, 1RM-8, 1RM-9		
4040M-10-11, 4040M-12-13, 4040M-14-15, 4040M-16-17, 4040M-18-19, 4040M-8-9		
8069, 8071, 8073		



Carro 40" 8 cajones + cofre 4 cajones con 758 herramientas



### MONSTER



 € 8.497,05 1 MONSTER

1370 x 501 x 1100 mm

FF1BSET-MONSTER

Carro 9 cajones E77 con composición para auto



### AUTO



 € 4.540,28 1 AUTO

976 x 510 x 820 mm

FF1ASET-AUTO

Carro E72 5 cajones con composición 158 piezas



### BASIC1



 € 1.507,96 1 BASIC

952 x 510 x 782 mm

FF1ASET-BASIC

Carro E77 9 cajones + cofre E87 4 cajones con 560 htas.



### XLARGE



 € 7.069,07 1 XLARGE

1360 x 510 x 820 mm

FF1ASET-XLARGE

Carro con composición general - 346 piezas



### LARGE



 € 2.731,82 1 LARGE

952 x 510 x 782 mm

FF1ASET-LARGE

Carro 40" negro con 6 cajones - 187 piezas













### 1475KXL6CBK-FF6



 € 3.014,68 1 1475KXL6CBK-FF6

986 x 501 x 1100 mm

FF1A65		
FF1A66		
FF1A67		
FF1A68		
FF1A194		



Carro 40" negro con 6 cajones - 210 piezas



**1475KXL6CBK-FF5**

Icon	€	Icon	Icon
	986 x 501 x 1100 mm	3.786,80	1 1475KXL6CBK-FF5

FF1A48		
FF1A49		
FF1A50		
FF1A51		
FF1A213		
FF1A53		

Carro Premium E77 26" con 9 cajones



**1477K9**

Icon	€	Icon	Icon
	976 x 510 x 820 mm	1.354,45	1 1477K9
	976 x 510 x 820 mm	1.354,45	1 1477K9BLACK
	976 x 510 x 820 mm	1.354,45	1 1477K9GREY
	976 x 510 x 820 mm	1.354,45	1 1477K9WHITE
	976 x 510 x 820 mm	1.354,45	1 1477K9RED

Carro Premium E77 26" con 8 cajones



**1477K8**

Icon	€	Icon	Icon
	976 x 510 x 820 mm	1.297,80	1 1477K8
	976 x 510 x 820 mm	1.297,80	1 1477K8BLACK

Icon	€	Icon	Icon
	976 x 510 x 820 mm	1.297,80	1 1477K8GREY
	976 x 510 x 820 mm	1.297,80	1 1477K8WHITE
	976 x 510 x 820 mm	1.297,80	1 1477K8RED

Carro Premium E77 26" con 7 cajones



**1477K7**

Icon	€	Icon	Icon
	976 x 510 x 820 mm	1.246,30	1 1477K7
	976 x 510 x 820 mm	1.246,30	1 1477K7BLACK
	976 x 510 x 820 mm	1.246,30	1 1477K7GREY
	976 x 510 x 820 mm	1.246,30	1 1477K7WHITE
	976 x 510 x 820 mm	1.246,30	1 1477K7RED

Carro Premium E77 26" con 6 cajones



**1477K6**

Icon	€	Icon	Icon
	976 x 510 x 820 mm	1.179,35	1 1477K6
	976 x 510 x 820 mm	1.179,35	1 1477K6BLACK
	976 x 510 x 820 mm	1.179,35	1 1477K6GREY
	976 x 510 x 820 mm	1.179,35	1 1477K6WHITE
	976 x 510 x 820 mm	1.179,35	1 1477K6RED

Cofre Premium E87 26" con 4 cajones



**1487K4**

Icon	€	Icon	Icon
	402 x 510 x 692 mm	1.033,41	1 1487K4
	402 x 510 x 692 mm	1.033,41	1 1487K4BLACK
	402 x 510 x 692 mm	1.033,41	1 1487K4GREY

Cofre Premium E87 con 4 cajones sobre ruedas



**1487K4W**

Icon	€	Icon	Icon
	564 x 510 x 692 mm	1.056,23	1 1487K4W
	564 x 510 x 692 mm	1.056,23	1 1487K4BKW

Carro E72 26" con 8 cajones



**1472K8**

Icon	€	Icon	Icon
	952 x 510 x 782 mm	803,40	1 1472K8
	952 x 510 x 782 mm	803,40	1 1472K8BLACK
	952 x 510 x 782 mm	803,40	1 1472K8GREY
	952 x 510 x 782 mm	803,40	1 1472K8WHITE
	952 x 510 x 782 mm	803,40	1 1472K8RED
	952 x 510 x 782 mm	803,40	1 1472K8BLUE

Carro E72 26" con 7 cajones



**1472K7**

	€		
952 x 510 x 782 mm	762,20	1	1472K7
952 x 510 x 782 mm	762,20	1	1472K7BLACK
952 x 510 x 782 mm	762,20	1	1472K7GREY
952 x 510 x 782 mm	762,20	1	1472K7WHITE
952 x 510 x 782 mm	762,20	1	1472K7RED
952 x 510 x 782 mm	762,20	1	1472K7BLUE

Carro E72 26" con 6 cajones



**1472K6**

	€		
952 x 510 x 782 mm	726,15	1	1472K6
952 x 510 x 782 mm	726,15	1	1472K6BLACK
952 x 510 x 782 mm	726,15	1	1472K6GREY
952 x 510 x 782 mm	726,15	1	1472K6WHITE
952 x 510 x 782 mm	726,15	1	1472K6RED
952 x 510 x 782 mm	726,15	1	1472K6BLUE

Carro E72 26" con 5 cajones



**1472K5**

	€		
952 x 510 x 782 mm	684,95	1	1472K5
952 x 510 x 782 mm	684,95	1	1472K5BLACK
952 x 510 x 782 mm	684,95	1	1472K5GREY
952 x 510 x 782 mm	684,95	1	1472K5WHITE
952 x 510 x 782 mm	684,95	1	1472K5RED
952 x 510 x 782 mm	684,95	1	1472K5BLUE

Cofre E82 26" con 4 cajones



**1482K4**

	€		
386 x 510 x 692 mm	590,08	1	1482K4
386 x 510 x 692 mm	590,08	1	1482K4BLACK
386 x 510 x 692 mm	590,08	1	1482K4GREY
386 x 510 x 692 mm	590,08	1	1482K4WHITE
386 x 510 x 692 mm	590,08	1	1482K4RED
386 x 510 x 692 mm	590,08	1	1482K4BLUE

Cofre E82 5 cajones sobre ruedas



**1482K5W**

	€		
542 x 515 x 699 mm	826,10	1	1482K5W

Cofres E82 4 cajones sobre ruedas



**1482K4W**

	€		
542 x 515 x 699 mm	737,59	1	1482K4W
542 x 515 x 699 mm	737,59	1	1482K4BKW

Panel de herramientas para 1477K



**1477K-AC12**

	€		
396 x 25 x 610 mm	182,36	1	1477K-AC12

Panel de herramientas superior lateral para 1477K



**1477K-AC13**

	€		
400 x 25 x 365 mm	121,58	1	1477K-AC13





Portadocumentos para 1477K



**1477K-AC14**

	€		
327 x 25 x 240 mm	54,71	1	1477K-AC14

Soporte para chaquetas para 1477K



**1477K-AC17**

	€		
68 x 65 x 435 mm	48,63	1	1477K-AC17

Soporte para latas para 1477K y 1472K



**1477K-AC20**

	€		
125 x 105 x 307 mm	43,76	1	1477K-AC20

Soporte para ordenador para 1477K



**1477K-AC15**

	€		
80 x 298 x 424 mm	145,89	1	1477K-AC15

Porta rollos de papel para 1477K y 1472K



**1477K-AC18**

	€		
33 x 265 x 313 mm	55,93	1	1477K-AC18

Soporte para herramienta neumática para 1477K y 1472K



**1477K-AC21**

	€		
115 x 175 x 302 mm	91,19	1	1477K-AC21

Soporte para lunas para 1477K



**1477K-AC16**

	€		
106 x 115 x 208 mm	243,15	1	1477K-AC16

Soporte para documentación para 1477K y 1472K



**1477K-AC19**

	€		
241 x 65 x 300 mm	48,63	1	1477K-AC19

Panel de herramientas lateral para 1477K y 1472K



**1477K-AC22**

	€		
659 x 18 x 300 mm	67,17	1	1477K-AC22

Bandeja metálica plegable para carros E72 y 777



**1477K-AC30**

 €    
22 x 430 x 460 mm 127,45 1 1477K-AC30

Sistema de bloqueo con código PIN



**1477K-AC24**

 €    
135 x 36 x 62 mm 334,34 1 1477K-AC24

Encimera con centro de madera para 1477K



**1477K-ACTW**

 €    
20 x 510 x 550 mm 255,32 1 1477K-ACTW

Divisores de cajón para carros de 26"



**1477K-AC26**

  €    
48 x 2 x 147 mm 0.07 kg 83,79 1 1477K-AC26

Sistema de Bloqueo MIFARE para 1477K



**1477K-AC25**

 €    
135 x 36 x 62 mm 425,53 1 1477K-AC25

Encimera de composite para 1477K



**1477K-ACTP**

 €    
20 x 510 x 550 mm 105,78 1 1477K-ACTP

Cajón inferior para 1477K



**1477K-AC10**

 €    
110 x 390 x 495 mm 95,69 1 1477K-AC10

Encimera central de acero inoxidable para 1477K



**1477K-ACTSS**

 €    
20 x 510 x 550 mm 291,79 1 1477K-ACTSS

Encimera central para 1477K



**1477K-ACTD**

 €    
20 x 510 x 550 mm 207,24 1 1477K-ACTD





Encimera de acero inoxidable para 1472K



**1472K-ACTSS**

	€		
30 x 501 x 682 mm	340,42	1	1472K-ACTSS

Carro 53" con 7 cajones



**1476KXXL7BK**

	€		
986 x 501 x 1430 mm	2.950,36	1	1476KXXL7BK

Carro Classic C75 40" con 12 cajones



**1475KXL12**

	€		
986 x 501 x 1100 mm	1.478,05	1	1475KXL12
986 x 501 x 1100 mm	1.478,05	1	1475KXL12BLACK
986 x 501 x 1100 mm	1.478,05	1	1475KXL12RED

Encimera de madera de castaño para 1472K



**1472K-ACTW**

	€		
30 x 501 x 680 mm	314,89	1	1472K-ACTW

Carro 53" con 12 cajones



**1471KXXL12BKTSS**

	€		
1016 x 501 x 1440 mm	2.814,65	1	1471KXXL12BKTSS

Carro Classic C75 40" con 8 cajones



**1475KXL8**

	€		
986 x 501 x 1100 mm	1.421,40	1	1475KXL8
986 x 501 x 1100 mm	1.421,40	1	1475KXL8BLACK
986 x 501 x 1100 mm	1.421,40	1	1475KXL8BLUE
986 x 501 x 1100 mm	1.421,40	1	1475KXL8RED

Encimera MDF para 1472K



**1472K-ACTD**

	€		
30 x 501 x 682 mm	255,32	1	1472K-ACTD

Carro C75 extra grande



**1475KXXL8CWTSS**

	€		
1218 x 500 x 1505 mm	1089 kg 4.802,35	1	1475KXXL8CWTSS

Carro Classic C75 40" con 7 cajones



**1475KXL7**

	€		
986 x 501 x 1100 mm	1.369,90	1	1475KXL7
986 x 501 x 1100 mm	1.369,90	1	1475KXL7BLACK
986 x 501 x 1100 mm	1.369,90	1	1475KXL7BLUE
986 x 501 x 1100 mm	1.369,90	1	1475KXL7RED

Carro Classic C75 40" 6 cajones



**1475KXL6**

	€		
986 x 501 x 1100 mm	1.318,40	1	1475KXL6
986 x 501 x 1100 mm	1.318,40	1	1475KXL6BLACK
986 x 501 x 1100 mm	1.318,40	1	1475KXL6BLUE
986 x 501 x 1100 mm	1.318,40	1	1475KXL6RED

Carro Classic C75 40" con 6 cajones y armario



**1475KXL6C**

	€		
986 x 501 x 1100 mm	1.431,70	1	1475KXL6C
986 x 501 x 1100 mm	1.658,49	1	1475KXL6CBLACK

Cofre Classic C85, 40" con 4 cajones



**1485KXL4**

	€		
417 x 500 x 1016 mm	844,97	1	1485KXL4
417 x 500 x 1016 mm	844,97	1	1485KXL4BLACK
417 x 500 x 1016 mm	844,97	1	1485KXL4BLUE
417 x 500 x 1016 mm	844,97	1	1485KXL4RED

Carro Classic C75 26" con 8 cajones



**1475K8**

	€		
956 x 501 x 763 mm	890,95	1	1475K8
956 x 501 x 763 mm	890,95	1	1475K8BLACK
956 x 501 x 763 mm	890,95	1	1475K8BLUE
956 x 501 x 763 mm	890,95	1	1475K8RED

Carro Classic C75 26" con 7 cajones



**1475K7**

	€		
956 x 501 x 763 mm	849,75	1	1475K7
956 x 501 x 763 mm	849,75	1	1475K7BLACK
956 x 501 x 763 mm	849,75	1	1475K7BLUE
956 x 501 x 763 mm	849,75	1	1475K7RED

Carro Classic C75



**1475K6**

	€		
956 x 501 x 763 mm	813,70	1	1475K6
956 x 501 x 763 mm	813,70	1	1475K6BLACK
956 x 501 x 763 mm	813,70	1	1475K6BLUE
956 x 501 x 763 mm	813,70	1	1475K6RED

Carro especial altura baja



**1470K7LH**

	€		
755 x 501 x 760 mm	804,56	1	1470K7LH

Cofre Classic C85, 26" con 4 cajones



**1485K4**

	€		
417 x 500 x 677 mm	650,45	1	1485K4
417 x 500 x 677 mm	650,45	1	1485K4BLACK
417 x 500 x 677 mm	650,45	1	1485K4BLUE
417 x 500 x 677 mm	650,45	1	1485K4RED

Encimera de acero inoxidable para carro 53"



**1475KXXL-ACTSS**

	€		
45 x 495 x 1347 mm	404,31	1	1475KXXL-ACTSS

Encimera de madera para carro 53"



**1475KXXL-ACTW**

	€		
45 x 495 x 1347 mm	732,12	1	1475KXXL-ACTW



Encimera de Acero Inox 26" y 40"



**1470K-ACTSS**

Icon	€	Icon	Icon
40 x 495 x 1010 mm	<b>476,08</b>	1	1470KXL-ACTSS
38 x 495 x 670 mm	<b>396,74</b>	1	1470K-ACTSS

Armario lateral negro para carro 1475KXL



**1475KXL-AC20BK**

Icon	€	Icon	Icon
820 x 503 x 419 mm	<b>488,06</b>	1	1475KXL-AC20BK

Accesorio lateral para carros



**1470K-AC3**

Icon	€	Icon	Icon
140 x 90 x 457 mm	<b>46,29</b>	1	1470K-AC3

Encimera de madera de castaño



**1470K-ACTW**

Icon	€	Icon	Icon
40 x 500 x 1012 mm	<b>388,96</b>	1	1470KXL-ACTW
40 x 497 x 674 mm	<b>246,35</b>	1	1470K-ACTW

Bandeja plegable para carro



**1470K-AC1**

Icon	€	Icon	Icon
9 x 455 x 395 mm	<b>105,80</b>	1	1470K-AC1

Superficie 455x460

Porta documentos para carros



**1470K-AC4**

Icon	€	Icon	Icon
180 x 83 x 360 mm	<b>52,90</b>	1	1470K-AC4

Encimera DM 26" y 40"



**1470K-ACTD**

Icon	€	Icon	Icon
40 x 495 x 1012 mm	<b>260,58</b>	1	1470KXL-ACTD
40 x 497 x 674 mm	<b>203,37</b>	1	1470K-ACTD

Barra metálica de 23 agujeros para destornilladores



**1470K-AC2**

Icon	€	Icon	Icon
280 x 100 x 428 mm	<b>125,64</b>	1	1470K-AC2

Se sujeta a los laterales del carro

Panel metálico perforado para alojar herramientas



**1470K-ACSIDE**

Icon	€	Icon	Icon
822 x 20 x 418 mm	<b>85,96</b>	1	1470K-ACSIDE

Dimensiones: 822x429mm

Encimera de ABS para carros de 26"



**1470K-AC7**

45 x 497 x 674 mm € 133,47 1 1470K-AC7

Carros de acero de tres bandejas



**1470KC3A**

1051 x 435 x 764 mm € 203,98 1 1470KC3A

Transportador plegable con capacidad de 120 Kg



**1430FT120**

1077 x 520 x 487 mm 6.4 kg € 131,30 1 1430FT120

Panel lateral con agujeros y ganchos



**1475K-ACSIDE**

822 x 20 x 418 mm € 64,91 1 1475K-ACSIDE

Carro dos bandejas



**1470KC2**

1051 x 435 x 764 mm € 187,08 1 1470KC2

Bandeja metálica ajustable para carros con armario en lateral



**1470KXLC-TRAY**

470 x 10 x 310 mm € 69,93 1 1470KXLC-TRAY

Bandeja central para 1470KC2



**1470KCTRAY**

750 mm 420 mm € 46,50 1 1470KCTRAY

Composición para uso general en 11 foams, 758 piezas



**FF1BSET-MONSTER**

40 x 445 x 880 mm € 7.074,97 1 FF1BSET-MONSTER

- FF1B01LM
- FF1B02LM
- FF1B03LM
- FF1B04LM
- FF1B05LM
- FF1B10LM
- FF1B11LM
- FF1B08LM
- FF1B09LM
- FF1B06LM
- FF1B07LM





Incluye 141 piezas



### FF1B01LM

35 x 445 x 880 mm € 684,49 1 FF1B01LM

6700SM-10, 6700SM-11, 6700SM-12, 6700SM-13, 6700SM-14, 6700SM-4, 6700SM-4.5, 6700SM-5, 6700SM-5.5, 6700SM-6, 6700SM-7, 6700SM-8, 6700SM-9		
6700SZ-1/2, 6700SZ-1/8, 6700SZ-9/16, 6700SZ-1/4, 6700SZ-11/32, 6700SZ-3/16, 6700SZ-3/8, 6700SZ-5/16, 6700SZ-7/16, 6700SZ-7/32, 6700SZ-9/32, 6700SZ-5/32		
6700TORX-E4, 6700TORX-E5, 6700TORX-E6, 6700TORX-E7, 6700TORX-E8, 6700TORX-E10		
6950SL		
6962L, 6960, 6961		
6972H		
7400SM-10, 7400SM-11, 7400SM-12, 7400SM-13, 7400SM-14, 7400SM-15, 7400SM-16, 7400SM-17, 7400SM-18, 7400SM-19, 7400SM-20, 7400SM-21, 7400SM-22, 7400SM-6, 7400SM-7, 7400SM-8, 7400SM-9		
7400TORX-E10, 7400TORX-E11, 7400TORX-E12, 7400TORX-E14, 7400TORX-E16, 7400TORX-E18		
7406ZZ-16, 7406ZZ-21		
7409TORX-R-T27, 7409TORX-R-T30, 7409TORX-R-T40, 7409TORX-R-T45, 7409TORX-R-T50		
7409TORX-T25, 7409TORX-T27, 7409TORX-T30, 7409TORX-T40, 7409TORX-T45, 7409TORX-T50		
7750SL		
2058-BR, K6650-1/4-1P, 6954, 6963, 7764		
8164-1/2		
A6800DM-10, A6800DM-12, A6800DM-13, A6800DM-4, A6800DM-5, A6800DM-5.5, A6800DM-6, A6800DM-7, A6800DM-8, A6800DM-9, A6800DM-11, A6800DM-14		
A6800DZ-9/16, A6800DZ-1/2, A6800DZ-1/4, A6800DZ-11/32, A6800DZ-3/16, A6800DZ-3/8, A6800DZ-5/16, A6800DZ-7/16, A6800DZ-7/32, A6800DZ-9/32		
A7400DZ-1/2, A7400DZ-11/16, A7400DZ-3/4, A7400DZ-3/8, A7400DZ-5/8, A7400DZ-7/16, A7400DZ-17/32, A7400DZ-9/16, A7400DZ-19/32, A7400DZ-13/16, A7400DZ-7/8, A7400DZ-1/4, A7400DZ-5/16		

K6625-1/4-1P		
6956		
6966		
7760, 7761		
7762		
7765		
7766		
7409BH-4, 7409BH-5, 7409BH-6, 7409BH-8, 7409BH-10		
A7402DM-10, A7402DM-11, A7402DM-12, A7402DM-13, A7402DM-14, A7402DM-15, A7402DM-16, A7402DM-17, A7402DM-18, A7402DM-19, A7402DM-8, A7402DM-9		
K6650-3/8-1P		
7756		

Incluye 76 piezas



### FF1B02LM

40 x 445 x 880 mm € 885,11 1 FF1B02LM

7800DM-10, 7800DM-11, 7800DM-12, 7800DM-13, 7800DM-14, 7800DM-15, 7800DM-16, 7800DM-17, 7800DM-18, 7800DM-19, 7800DM-20, 7800DM-21, 7800DM-22, 7800DM-24, 7800DM-27, 7800DM-30, 7800DM-32, 7800DM-34, 7800DM-36		
7800DZ-1, 7800DZ-1.1/16, 7800DZ-1.1/4, 7800DZ-1.1/8, 7800DZ-1.3/16, 7800DZ-1/2, 7800DZ-11/16, 7800DZ-13/16, 7800DZ-15/16, 7800DZ-25/32, 7800DZ-3/4, 7800DZ-3/8, 7800DZ-5/8, 7800DZ-7/16, 7800DZ-7/8, 7800DZ-9/16, 7800DZ-19/32		
7809M-10, 7809M-12, 7809M-14, 7809M-4, 7809M-5, 7809M-6, 7809M-7, 7809M-8		
8150SL		
SBS87		
K7801M-13, K7801M-15, K7801M-16, K7801M-17, K7801M-18, K7801M-19, K7801M-21, K7801M-22, K7801M-24		
K8160D-2		
K7806M-13, K7806M-14, K7806M-16, K7806M-17, K7806M-18, K7806M-19, K7806M-21, K7806M-22, K7806M-24		
7809M-5-100, 7809M-6-100, 7809M-7-100, 7809M-8-120, 7809M-10-140		
K6650-1/2-1P		
8160-3, 8160-5, 8160-10		
8171		
8166		

Incluye 36 piezas



### FF1B03LM

35 x 445 x 880 mm € 625,48 1 FF1B03LM

111M-10, 111M-11, 111M-12, 111M-13, 111M-14, 111M-15, 111M-16, 111M-17, 111M-18, 111M-19, 111M-20, 111M-21, 111M-22, 111M-24, 111M-27, 111M-30, 111M-32, 111M-34, 111M-8, 111M-9		
1RM-10, 1RM-11, 1RM-12, 1RM-13, 1RM-14, 1RM-15, 1RM-16, 1RM-17, 1RM-18, 1RM-19, 1RM-21, 1RM-22, 1RM-24, 1RM-27, 1RM-8, 1RM-9		

Incluye 26 piezas



### FF1B04LM

35 x 445 x 880 mm € 767,09 1 FF1B04LM

1RM-30, 1RM-32		
111Z-1, 111Z-1.1/16, 111Z-1.1/4, 111Z-1.1/8, 111Z-1/2, 111Z-11/16, 111Z-13/16, 111Z-15/16, 111Z-3/4, 111Z-3/8, 111Z-5/16, 111Z-5/8, 111Z-7/16, 111Z-7/8, 111Z-9/16		
4040M-10-11, 4040M-12-13, 4040M-14-15, 4040M-16-17, 4040M-18-19, 4040M-8-9		
5515T		
BLTS7P		
2535L		



Incluye 32 piezas



### FF1B05LM

	€		
35 x 445 x 880 mm	767,09	1	FF1B05LM

1150-1/2H/P	
1520 G	
1620	
2101S-160	1000 V IEC60900
21HDG-160	
2223 S-150	1000 V IEC60900
2430 G-160	
2430 S-200	1000 V IEC60900
2628 G-180	
2628 S-180	1000 V IEC60900
2744	
426TOR9	6.03P-4.5mm
KBGU-10P-DISPEN	
KERU-01	
MTC-5-16-C1	
8224	1€
9029, 9031	
806-1-3	
C3330R	
C3530	
C3230	
C3640	

Incluye 88 piezas



### FF1B06LM

	€		
40 x 445 x 880 mm	413,05	1	FF1B06LM

700-2.5-50, 700-2-50, 700-3-50	
701-00-50, 701-0-50, 701-1-75	
703-10-50, 703-15-75, 703-6-50, 703-7-50, 703-8-50, 703-9-50	

808050L	
BE-8010S	
BE-8020, BE-8040	
BE-8040SL, BE-8050SL	
BE-8150, BE-8155, BE-8256	
BE-8355	
BE-8600, BE-8611, BE-8621, BE-8623	
BE-8600S	
BE-8602	
BE-8610SL, BE-8620SL	
BE-8702, BE-8725	
BE-8820SL	
BE-8870	
BE-8975B	
BE-9777B	
BE-9787	
BE-9770	
BE-9785	

Incluye 169 piezas



### FF1B07LM

	€		
40 x 445 x 880 mm	708,08	1	FF1B07LM

BE-8256TB, BE-8258TB	
BE-8620TB, BE-8623TB	
59/S100BC	
7455-200	
BE-8907, BE-8908, BE-8909, BE-8910, BE-8915, BE-8920, BE-8925, BE-8927, BE-8930, BE-8940	
BE-8811, BE-8821	
BE-8830	
BE-8802	
BE5049T	
BE-7607	

Incluye 45 piezas



### FF1B08LM

	€		
40 x 445 x 880 mm	413,05	1	FF1B08LM

1-100-08-2-2	
1-170-08-2-2	
1-210-08-2-2	
1-230-08-2-2	
1435/5	
2484-30, 2484-45, 2484-60	
3734-2, 3734-3, 3734-4, 3734-5, 3734-6, 3734-8	
3735-4-120, 3735-5-120	
3740-150, 3740-250	
4543-3	
4611-3	
481-400	
7865	
3625N-32	
1418-4, 1418-5, 1418-6, 1418-7.5	

Incluye 21 piezas



### FF1B09LM

	€		
35 x 445 x 880 mm	330,44	1	FF1B09LM

900T-025-100, 900T-030-100, 900T-040-150, 900T-050-150, 900T-060-200, 900T-080-200	
901T-010-100, 901T-015-150, 901T-020-150, 901T-025-150, 901T-027-150, 901T-030-200, 901T-040-200	
BE256-155, BE256-178, BE256-250	
BE66152	
BT10P325, BT10P330, BT10P338	
1544	



Incluye 20 piezas



### FF1B10LM

	€		
45 x 445 x 880 mm	436,66	1	FF1B10LM

2633/S4	
2800-140, 2800-180	
2890-125, 2890-180	
2900-140, 2900-180	
2951-180	
2952-165	
2963-280	
2965-200	
2990-125, 2990-180	
BE-8986	
325	
2681	
CR B 02	

Incluye 104 piezas



### FF1B11LM

	€		
50 x 445 x 880 mm	424,85	1	FF1B11LM

RAIL-264	
CLIPS-1/4	
CLIPS-3/8	
CLIPS-1/2	
SLX 17	

Composición para uso general en 12 foams, 560 piezas



### FF1ASET-XLARGE

	€		
40 x 543 x 445 mm	4.885,81	1	FF1ASET-XLARGE

FF1A195LM	
FF1A196LM	
FF1A197LM	
FF1A198LM	
FF1A199LM	
FF1A200LM	
FF1A201LM	
FF1A202LM	
FF1A203LM	
FF1A204LM	
FF1A205LM	
FF1A206LM	

Composición para uso general en 6 foams, 346 piezas



### FF1ASET-LARGE

	€		
40 x 543 x 445 mm	2.130,82	1	FF1ASET-LARGE

FF1A207LM	
FF1A208LM	
FF1A209LM	
FF1A210LM	
FF1A211LM	
FF1A212LM	

Composición para auto en 6 foams, 175 piezas



### FF1ASET-BASIC

	€		
40 x 543 x 445 mm	928,82	1	FF1ASET-BASIC

FF1A214LM	
FF1A215LM	
FF1A216LM	

SET 7 FOAMS PARA MRO, 256 PIEZAS



### FF1ASET-MRO2

	€		
530 x 600 x 800 mm	2.918,79	1	FF1ASET-MRO2

FF1A130	
FF1A131	
FF1A132	
FF1A133	
FF1A134	
FF1A135	
FF1A136	

SET 5 FOAMS PARA MRO, 188 PIEZAS



### FF1ASET-MRO3

	€		
530 x 600 x 800 mm	2.106,17	1	FF1ASET-MRO3

FF1A138		
FF1A134		
FF1A139		
FF1A141		
FF1A137		

**SET 4 FOAMS PARA MRO, 147 PIEZAS**



**FF1ASET-MRO4**

€

530 x 600 x 800 mm    1.416,32    1    FF1ASET-MRO4

FF1A143		
FF1A145		
FF1A134		
FF1A142		

**SET 3 FOAMS PARA MRO, 84 PIEZAS**



**FF1ASET-MRO5**

€

530 x 600 x 800 mm    1.129,53    1    FF1ASET-MRO5

FF1A147		
FF1A146		
FF1A134		

**Composición para auto en 8 foams, 357 piezas**



**FF1ASET-AUTO**

€

40 x 543 x 445 mm    3.387,45    1    FF1ASET-AUTO

FF1A218LM		
FF1A219LM		
FF1A220LM		
FF1A221LM		
FF1A222LM		
FF1A223LM		
FF1A224LM		
FF1A225LM		

**SET DE 5 FOAMS PARA AUTO-196 HERRAMIENTAS**



**FF1ASET-AUTO1**

€

50 x 543 x 445 mm    2.469,92    1    FF1ASET-AUTO1

FF1A19		
FF1A20		
FF1A21		
FF1A23		
FF1A22		

**SET DE 4 FOAMS PARA AUTO-168 HERRAMIENTAS**



**FF1ASET-AUTO2**

€

50 x 543 x 445 mm    1.745,31    1    FF1ASET-AUTO2

FF1A19		
FF1A24		
FF1A21		
FF1A25		

**SET 3 FOAMS PARA AUTO, 140 PIEZAS**



**FF1ASET-AUTO3**

€

50 x 543 x 445 mm    1.488,24    1    FF1ASET-AUTO3

FF1A28		
FF1A26		
FF1A27		





Set de 4 foams para auto



**FF1ASET-AUTO6**

50 x 543 x 445 mm € 1.452,87 1 FF1ASET-AUTO6

FF1A19	
FF1A72	
FF1A70	
FF1A71	

Incluye 62 pieces



**FF1ASET-AUTO-M1**

50 x 543 x 445 mm € 914,61 1 FF1ASET-AUTO-M1

BP910	
BP909TH	
BE-9678	
BE-9675	
29M-30	
2997-250	
1995LM-9, 1995LM-8, 1995LM-6	
3750	
1177-SCRIBE	
K7801M-9, K7801M-10, K7801M-11, K7801M-12, K7801M-13, K7801M-14, K7801M-15, K7801M-16, K7801M-17, K7801M-18, K7801M-19, K7801M-21, K7801M-22, K7801M-23, K7801M-24, K7801M-30, K7801M-32	
K7806M-15, K7806M-21, K7806M-24, K7806M-27	
K8901M-32, K8901M-34, K8901M-36	
K8964D	
K8167S	
K8160D-3	
2800-150	

2900-150	
3734S/6	
BE-8258TB	

Incluye 54 pieces



**FF1ASET-AUTO-M2**

60 x 543 x 445 mm € 1.852,83 1 FF1ASET-AUTO-M2

BE301	
K7801TORX-E10, K7801TORX-E12, K7801TORX-E14, K7801TORX-E16, K7801TORX-E18, K7801TORX-E20	
K8160D-2	
BE301CM	
BWHEPSSH8	
BE51038, BE510310, BE510312	
BP822	
BP825	

Incluye 34 pieces



**FF1ASET-AUTO-M3**

40 x 543 x 445 mm € 950,02 1 FF1ASET-AUTO-M3

BE1GP5-T	
6968	
BE1SP1F	
BE6OF108	
BE6307414F	
BE6OFW	

BE1FFWF	
BE63064514F1	
BE6810Z, BE6810	
BE6FCP	
52	
1546	
5515M	
BE1P	
7455-60	
BE1FLD2, BE1FLD1, BE1FLD3	
BE65F65120	
7764, 6962-W, 6954	
8164-1/2	
BE6302712F	
BE6701VAG	
BE62110	
BE1310P427	
7406ZZ-21, 7406ZZ-16	
BE1SP14L	
BE1GP5	
2421GC-160IP	
8166	

Incluye 23 pieces



**FF1ASET-AUTO-M4**

60 x 543 x 445 mm € 1.357,17 1 FF1ASET-AUTO-M4

BS618	
4545-N1, 4545-N11	
4545-1, 4545-2	
MTB-3-16	
361-14	
8900SM-41	
BS52	
747-22, 747-21, 747-19, 747-17, 747-15, 747-14, 747-13, 747-12	
BS40VAG	
BS56	
BS100PSA1	
BS45BMW	
8157-24	
8171	

Incluye 32 piezas



### FF1ASET-AUTO-M5

45 x 543 x 445 mm € 590,08 1 FF1ASET-AUTO-M5

319	
484-1000	
SB3654BM-20	
3625S-44	
B192.004.200	
BE-8258TB	
2484/S4	
6225D	
B194.030.150, B194.025.125, B194.020.100, B194.010.075	
600.005.012	
BBS165	
K7801TORX-E10, K7801TORX-E12, K7801TORX-E14, K7801TORX-E16, K7801TORX-E18, K7801TORX-E20, K7801TORX-E24	
BBR203P920, BBR203P925, BBR203P930, BBR203P940, BBR203P945, BBR203P950, BBR203P955, BBR203P960	

Incluye 42 piezas



### FF1ASET-AUTO-M6

40 x 543 x 445 mm € 1.079,83 1 FF1ASET-AUTO-M6

FM10	
782-U	
BBR405	
BBR400	
BBR210P3	
BBR6131	
BBR204	

BBR1501	
BBR501011, BBR50121314	
2900-215	
7823	
BBR100	
1154	
6M-16-17, 6M-14-15	
1949M-17-19, 1949M-12-13, 1949M-10-11, 1949M-8-9	

Incluye 139 piezas



### FF1A195LM

40 x 445 x 543 mm € 413,05 1 FF1A195LM

A6800DZ-9/16, A6800DZ-1/2, A6800DZ-1/4, A6800DZ-11/32, A6800DZ-3/16, A6800DZ-3/8, A6800DZ-5/16, A6800DZ-7/16, A6800DZ-7/32, A6800DZ-9/32	
K6625-1/4-1P	
K6650-1/4-1P, 6954, 6963, 2058-BR	
K6650-3/8-1P	
7767	
8167	
59/S31B	
SL25L	
S330L	

Incluye 67 piezas



### FF1A196LM

40 x 445 x 543 mm € 519,26 1 FF1A196LM

7800DZ-1.1/16, 7800DZ-1.1/4, 7800DZ-1.1/8, 7800DZ-1.3/16, 7800DZ-1/2, 7800DZ-11/16, 7800DZ-13/16, 7800DZ-15/16, 7800DZ-25/32, 7800DZ-3/4, 7800DZ-3/8, 7800DZ-5/8, 7800DZ-7/16, 7800DZ-7/8, 7800DZ-9/16, 7800DZ-19/32	
--	--

7809M-10, 7809M-12, 7809M-14, 7809M-4, 7809M-5, 7809M-6, 7809M-7, 7809M-8	
7809M-5-100, 7809M-6-100, 7809M-7-100, 7809M-8-120, 7809M-10-140	
K6650-1/2-1P	
S1612L	
8967	
S240	

Incluye 36 piezas



### FF1A197LM

40 x 445 x 543 mm € 436,66 1 FF1A197LM

1150-1/2H/P	
2744	
426TOR9	
K7801M-13, K7801M-15, K7801M-16, K7801M-17, K7801M-18, K7801M-19, K7801M-21, K7801M-22, K7801M-24	
K8160D-2	
K7806M-13, K7806M-14, K7806M-16, K7806M-17, K7806M-18, K7806M-19, K7806M-21, K7806M-22, K7806M-24	
KBGU-10P-DISPEN	
KERU-01	
MTC-5-16-C1	
325	
1544	

Incluye 20 piezas



### FF1A198LM

35 x 445 x 543 mm € 295,03 1 FF1A198LM

111M-10, 111M-11, 111M-12, 111M-13, 111M-14, 111M-15, 111M-16, 111M-17, 111M-18, 111M-19, 111M-20, 111M-21, 111M-22, 111M-24, 111M-27, 111M-30, 111M-32, 111M-34, 111M-8, 111M-9	
--	--





Incluye 23 piezas



### FF1A199LM

35 x 445 x 543 mm € 625,48 1 FF1A199LM

- 1RM-10, 1RM-11, 1RM-12, 1RM-13, 1RM-14, 1RM-15, 1RM-16, 1RM-17, 1RM-18, 1RM-19, 1RM-21, 1RM-22, 1RM-24, 1RM-8, 1RM-9
- 4040M-10-11, 4040M-12-13, 4040M-14-15, 4040M-16-17, 4040M-18-19, 4040M-8-9
- 9029, 9031

Incluye 14 piezas



### FF1A200LM

35 x 445 x 543 mm € 507,46 1 FF1A200LM

- 1520 G
- 1620
- 2101G-160
- 2223 S-150
- 2233 D-160
- 2430 G-190HD
- 2628 G-180
- 2890-180
- 2990-180
- C3330R
- C3530
- C3230
- C3640
- 8224

Incluye 37 piezas



### FF1A201LM

40 x 445 x 543 mm € 271,44 1 FF1A201LM

- BE-8256TB
- BE-8620TB, BE-8623TB
- 700-2-50
- 701-00-50, 701-0-50, 701-1-75
- 703-10-50, 703-15-75, 703-6-50, 703-7-50, 703-8-50, 703-9-50
- BE-8040SL
- BE-8040
- BE-8150, BE-8155, BE-8256
- BE-8355
- BE-8600, BE-8611, BE-8621, BE-8623
- BE-8602
- BE-8811, BE-8821
- BE-8802
- BE-8870
- BE-9787

Incluye 39 piezas



### FF1A202LM

40 x 445 x 543 mm € 177,03 1 FF1A202LM

- 900T-025-100, 900T-030-100, 900T-040-150, 900T-050-150, 900T-060-200, 900T-080-200
- BE-8907, BE-8908, BE-8909, BE-8910, BE-8915, BE-8920, BE-8925, BE-8927, BE-8930
- BE-8702, BE-8725
- BE-9770
- BE-9785

Incluye 114 piezas



### FF1A203LM

40 x 445 x 543 mm € 165,22 1 FF1A203LM

- 59/S100BC
- 808050L
- 2058-BR
- 901T-010-100, 901T-015-150, 901T-020-150, 901T-025-150, 901T-027-150, 901T-030-200, 901T-040-200

Incluye 40 piezas



### FF1A204LM

40 x 445 x 543 mm € 271,44 1 FF1A204LM

- 1-100-08-2-2
- 1-170-08-2-2
- 1-210-08-2-2
- 1-230-08-2-2
- 1435/5
- 3734-2, 3734-3, 3734-4, 3734-5, 3734-6, 3734-8
- 3735-4-120, 3735-5-120
- 3740-150, 3740-250
- 481-400
- 7865
- 3625N-32
- 1418-4, 1418-5, 1418-6, 1418-7.5

Incluye 14 piezas



**FF1A205LM**

35 x 445 x 543 mm    €    271,44    1    FF1A205LM

2484-45	
2633/S4	
2951-180	
5515T	
BE66152	
BE-8986	
BT10P330	
2681	
1450D-ISO	
806-1-3	
5515FL	

Incluye 17 piezas



**FF1A206LM**

50 x 445 x 543 mm    €    377,65    1    FF1A206LM

SLX 17	
--------	--

Incluye 192 piezas



**FF1A207LM**

40 x 445 x 543 mm    €    460,26    1    FF1A207LM

1150-1/2H/P	
59/S100BC	
808050L	
2058-BR, K6650-1/4-1P, 6963, 6954	
6956	
K6650-3/8-1P	
8967/S3	
6966	
696EX-08	
904T-060-150	
905T-060-100	
6973A	
SL25L	
S330	

Incluye 56 piezas



**FF1A208LM**

45 x 445 x 543 mm    €    401,25    1    FF1A208LM

2744	
7809M-10, 7809M-12, 7809M-14, 7809M-4, 7809M-5, 7809M-6, 7809M-7, 7809M-8	
K7801M-13, K7801M-15, K7801M-16, K7801M-17, K7801M-18, K7801M-19, K7801M-21, K7801M-22, K7801M-24	
K8160D-2	
KBGU-10P-DISPEN	
KERU-01	
319	
K6650-1/2-1P	
S240	

Incluye 21 piezas



**FF1A209LM**

35 x 445 x 543 mm    €    330,44    1    FF1A209LM

111M-10, 111M-11, 111M-12, 111M-13, 111M-14, 111M-15, 111M-16, 111M-17, 111M-18, 111M-19, 111M-20, 111M-21, 111M-22, 111M-24, 111M-27, 111M-30, 111M-32, 111M-34, 111M-8, 111M-9	
2535L	

Incluye 24 piezas



ergo®



**FF1A210LM**

40 x 445 x 543 mm    €    448,45    1    FF1A210LM

1RM-10, 1RM-11, 1RM-12, 1RM-13, 1RM-14, 1RM-15, 1RM-16, 1RM-17, 1RM-18, 1RM-19, 1RM-8, 1RM-9	
1520 G	
2101G-160	
2430 G-190HD	
2628 G-180	
BE-8602	
BE-8611, BE-8621	
BE-8811, BE-8821	
BE-8802	
8224	
9031	



Incluye 35 piezas



ergo



**FF1A211LM**

	€		
40 x 445 x 543 mm	200,62	1	FF1A211LM

900T-025-100, 900T-030-100, 900T-040-150, 900T-050-150, 900T-060-200, 900T-080-200		
BE-8910, BE-8915, BE-8920, BE-8925, BE-8930		
BE-8020, BE-8040		
BE-8050SL		
BE-8150, BE-8155		
BE-8355		
BE-9787		
BE-9770		

Incluye 18 piezas



ergo



**FF1A212LM**

	€		
35 x 445 x 543 mm	224,23	1	FF1A212LM

1-100-08-2-2		
1-210-08-2-2		
1-230-08-2-2		
3734-2, 3734-3, 3734-4, 3734-5, 3734-6, 3734-8		
3735-4-120		
3740-150, 3740-250		
426TOR9		
481-400		
BE-8986		
MTC-5-16-C1		
2446		
3625N-32		

Incluye 85 piezas



**FF1A213**

	€		
52 x 445 x 543 mm	1.014,92	1	FF1A213

8150SL		
7800SM-8, 7800SM-9, 7800SM-12, 7800SM-13, 7800SM-10, 7800SM-11, 7800SM-30, 7800SM-32, 7800SM-24, 7800SM-22, 7800SM-23, 7800SM-27, 7800SM-16, 7800SM-17, 7800SM-14, 7800SM-15, 7800SM-21, 7800SM-18, 7800SM-19		
7455-200		
7809TORX-T45, 7809TORX-T40, 7809TORX-T30, 7809TORX-T20, 7809TORX-T25		
7809M-6, 7809M-5, 7809M-8, 7809M-7, 7809M-10, 7809M-14, 7809M-12		
7809M-6-140, 7809M-5-180, 7809M-10-140, 7809M-8-120		
6950SL		
6962-W, K6650-1/4-1P		
6960-W, 6960W-6		
6968		
6700SM-9, 6700SM-10, 6700SM-7, 6700SM-8, 6700SM-13, 6700SM-14, 6700SM-11, 6700SM-12, 6700SM-4, 6700SM-6, 6700SM-5		
6709M-6, 6709M-8, 6709M-4, 6709M-5, 6709M-3		
A6709M-2.5, A6709M-5, A6709M-6, A6709M-3, A6709M-4		
6962L, 6960-14		
7400SM-17, 7400SM-18, 7400SM-15, 7400SM-16, 7400SM-19, 7400SM-9, 7400SM-10, 7400SM-7, 7400SM-8, 7400SM-13, 7400SM-14, 7400SM-11, 7400SM-12, 7400SM-6		
7760-W, 7761-W		
7750SL		
7768		
8160-5, 8160-10		
8166		

Incluye 91 piezas



**FF1A214LM**

	€		
40 x 445 x 543 mm	354,04	1	FF1A214LM

2058-BR, K6650-1/4-1P, 6963		
6956		
K6650-1/2-1P		
SL25		
8072		
2971G-250		
806-1-3		
2171G-160		
59/S31B		
S240		

Incluye 31 piezas



**FF1A215LM**

	€		
40 x 445 x 543 mm	306,84	1	FF1A215LM

111M-10, 111M-11, 111M-12, 111M-13, 111M-14, 111M-15, 111M-16, 111M-17, 111M-18, 111M-19, 111M-20, 111M-21, 111M-22, 111M-24, 111M-8, 111M-9		
BE-8910, BE-8915, BE-8920, BE-8925, BE-8930		
BE-8020, BE-8040		
BE-8155		
BE-8355		
BE-8602		
BE-8611, BE-8621		
BE-8811, BE-8821		
BE-8802		



Incluye 36 piezas



**FF1A216LM**

	€		
40 x 445 x 543 mm	236,02	1	FF1A216LM

1-100-08-2-2	
1-210-08-2-2	
1-230-08-2-2	
3734-3, 3734-4, 3734-5	
3735-4-120	
481-400	
BE-8986	
BE-9770	
S4RM-8-11, S4RM-12-15, S4RM-16-19	
KB18-01	
KSBG18-10DISPEN	
MTG-3-16	
WR2-MM	
3740-200	
317	

Incluye 79 piezas



**FF1A218LM**

	€		
45 x 445 x 543 mm	649,08	1	FF1A218LM

1178-SCRIBE	
1547	
74WR-200	
7805ZZ-16, 7805ZZ-21	

BBR201P64014, BBR201P64016,  
BBR201P64018, BBR201P67814,  
BBR201P67816, BBR201P67818



BWSS12P3	
MTC-3-13-C1	
7800SM-34, 7800SM-36	
SL25L	
SR200-MM	
S240	

Incluye 49 piezas



**FF1A219LM**

	€		
35 x 445 x 543 mm	377,65	1	FF1A219LM

1-100-08-2-2	
S1612L	
S18HEX	
S18TORX	

Incluye 21 piezas



**FF1A220LM**

	€		
35 x 445 x 543 mm	318,64	1	FF1A220LM

111M-10, 111M-11, 111M-12, 111M-13, 111M-14, 111M-15, 111M-16, 111M-17, 111M-18, 111M-19, 111M-20, 111M-21, 111M-22, 111M-23, 111M-24, 111M-27, 111M-30, 111M-32, 111M-8, 111M-9	
8071	

Incluye 42 piezas



**FF1A221LM**

	€		
40 x 445 x 543 mm	590,08	1	FF1A221LM

1RM-10, 1RM-11, 1RM-12, 1RM-13, 1RM-14, 1RM-17, 1RM-19, 1RM-8	
2681	
4040M-10-11, 4040M-12-13, 4040M- 14-15, 4040M-16-17, 4040M-18-19, 4040M-8-9	
8045LVDE	
806-1-1	
808050	
808050S	
9715-14-250	
BE-9575	
BE-9770	

Incluye 65 piezas



**FF1A222LM**

	€		
45 x 445 x 543 mm	401,25	1	FF1A222LM

BE-7805, BE-7806, BE-7807, BE-7808, BE-7809, BE-7810, BE-7811, BE-7813, BE-7855	
D/S14	
K8160D-1, K8160D-2	
K8167S	
BE-8135TB, BE-8145TB, BE-8150TB, BE-8155TB	
BE-8610TB, BE-8620TB, BE-8623TB	
1150-1/2H/P	
59/S31B	



Incluye 15 piezas



### FF1A223LM

	€		
35 x 445 x 543 mm	342,24	1	FF1A223LM

5226 DC	
158-N	
158-NB	
21HDG-200	
2430 G-190HD	
2628G-200IP	
2968-190	
8224 IP	
BE1P	
BE1TH-2.5, BE1TH-3, BE1TH-4, BE1TH-5, BE1TH-6, BE1TH-8	

Incluye 26 piezas



### FF1A224LM

	€		
40 x 445 x 543 mm	283,24	1	FF1A224LM

1435/8	
319	
3625S-35	
3734S/6	
3735-5-150	
3740-200	
3750	
3906-300-24-2P	
479-16	
KBFU-01	
BE256P3	

Incluye 60 piezas



### FF1A225LM

	€		
40 x 445 x 543 mm	295,03	1	FF1A225LM

2487	
2535F1	
2633/S4	
2485	
782-U	
BE5049T	
BE66152	
2484-45	
5515T-52	

FF1A01 - 77 piezas



### FF1A01

	€		
45 x 445 x 543 mm	720,62	1	FF1A01

A6800DM-4, A6800DM-5, A6800DM-6, A6800DM-7, A6800DM-8, A6800DM-9, A6800DM-10, A6800DM-11, A6800DM-12, A6800DM-13	
6700SM-4.5, 6700SM-5, 6700SM-5.5, 6700SM-6, 6700SM-7, 6700SM-8, 6700SM-9, 6700SM-10, 6700SM-11, 6700SM-12, 6700SM-13, 6700SM-4	
59S/22-1	
6950SL	
6954	
6956	
6960, 6961	
6966	
6972H	

7800SM-18, 7800SM-19, 7800SM-10, 7800SM-11, 7800SM-12, 7800SM-13, 7800SM-14, 7800SM-15, 7800SM-16, 7800SM-17, 7800SM-22, 7800SM-27, 7800SM-24, 7800SM-30, 7800SM-32

7805ZZ-21	
7807H	
B191.040.100, B191.055.150	
B192.001.100, B192.002.125	
8150SL	
8154-11	
8160-3, 8160-10	
8166	
6960-2	
6960-4	

FF1A02 - 25 piezas



### FF1A02

	€		
45 x 445 x 543 mm	264,98	1	FF1A02

111M-12, 111M-13, 111M-14, 111M-17, 111M-19, 111M-22, 111M-6, 111M-7, 111M-8, 111M-10	
6M-6-7, 6M-8-9, 6M-10-11, 6M-12-13, 6M-14-15, 6M-16-17, 6M-18-19, 6M-20-22	
808050L	

FF1A03 - 18 piezas



### FF1A03

	€		
50 x 445 x 543 mm	214,54	1	FF1A03



BE-9770	
MTB-5-25	
3734N-4-150, 3734N-6-150	
1-100-08-2-2	
2171G-160	
2971G-250	
481-400	
2678 G-160	
306	

FF1A04 - 30 piezas



**FF1A04**

	€		
50 x 445 x 543 mm	483,22	1	FF1A04

S4RM-12-15, S4RM-16-19, S4RM-8-11	
111M-30, 111M-32, 111M-6, 111M-7, 111M-8, 111M-9, 111M-10, 111M-11, 111M-12, 111M-13, 111M-14, 111M-15, 111M-16, 111M-17, 111M-18, 111M-19, 111M-21, 111M-22, 111M-24, 111M-27	
6M-10-11, 6M-12-13, 6M-14-15, 6M-17-19, 6M-6-7, 6M-8-9	
9071C	

Juego de destornilladores a carraca y puntas en bandeja de foam 3/3 Fit&Go con marcado láser (104 piezas)



**FF1A051**

	€		
50 x 445 x 543 mm	739,65	1	FF1A051

BE-9678	
SBS60-4, SBS60-4.5, SBS60-5, SBS60-5.5, SBS60-6, SBS60-7, SBS60-8, SBS60-9, SBS60-10, SBS60-11, SBS60-12, SBS60-13, SBS60-14	
SBS61	
SBS63-2, SBS63-4, SBS63-6	
SBS65	
SBS67	
SBS69	
7800SM-10, 7800SM-11, 7800SM-12, 7800SM-13, 7800SM-14, 7800SM-15, 7800SM-16, 7800SM-18, 7800SM-19, 7800SM-21, 7800SM-17, 7800SM-22, 7800SM-24, 7800SM-27, 7800SM-32, 7800SM-30	
SBS88	
59S/31-1	
6956	
6972H	
7809M-5, 7809M-6, 7809M-7, 7809M-8, 7809M-10, 7809M-12, 7809M-14, 7809M-17, 7809M-19	
7809TORX-T20, 7809TORX-T25, 7809TORX-T27, 7809TORX-T30, 7809TORX-T40, 7809TORX-T45, 7809TORX-T50, 7809TORX-T55, 7809TORX-T60	
808050	
8150SL	
8154-11	
8160-W	
8160-10	
8166	
6954	

FF1A06 - 23 piezas



**FF1A06**

	€		
45 x 445 x 543 mm	427,00	1	FF1A06

BE-8020L, BE-8040	
BE-8150, BE-8255, BE-8256	
BE-8350	

BE-8601	
BE-8610, BE-8620	
BE-8910, BE-8915, BE-8920, BE-8925, BE-8927, BE-8930	
MTB-3-16	
2101G-160IP	
2427 G-200 IP	
2535L	
2628 G-160IP	
2951-180	
5515T-52	
8224 IP	

FF1A07 - 15 piezas



**FF1A07**

	€		
40 x 445 x 543 mm	256,65	1	FF1A07

3734N-3-150, 3734N-5-150, 3734N-6-150	
3735N-4-120	
3740-175	
SQZ150003	
1-100-08-2-2	
1-210-08-2-2	
1-230-08-2-2	
2744	
3625W-35	
3745-150	
481-400	
782-U	
317	



FF1A08 - 168 piezas



**FF1A08**

60 x 445 x 543 mm 1.701,56 € 1 FF1A08

A6800DM-5.5, A6800DM-6, A6800DM-7, A6800DM-8, A6800DM-9, A6800DM-10, A6800DM-11, A6800DM-12, A6800DM-13	
A7402DM-10, A7402DM-11, A7402DM-12, A7402DM-13, A7402DM-14, A7402DM-15, A7402DM-16, A7402DM-17, A7402DM-18, A7402DM-19	
1544	
2058-BR, 6954, 7764	
6700SM-5.5, 6700SM-6, 6700SM-7, 6700SM-8, 6700SM-9, 6700SM-10, 6700SM-11, 6700SM-12, 6700SM-13	
6709M-3, 6709M-4, 6709M-5, 6709M-6, 6709M-8	
6709PH-1, 6709PH-2, 6709PH-3	
6709TORX-T20, 6709TORX-T25, 6709TORX-T27, 6709TORX-T30, 6709TORX-T40, 6709TORX-T8, 6709TORX-T9, 6709TORX-T10, 6709TORX-T15	
6950SL	
6956	
6958	
6960, 6961, 6962, 6962L, 6960-6, 6960-14	
6966	
6972H	
7400SM-6, 7400SM-7, 7400SM-8, 7400SM-9, 7400SM-10, 7400SM-11, 7400SM-12, 7400SM-13, 7400SM-14, 7400SM-15, 7400SM-16, 7400SM-17, 7400SM-18, 7400SM-19, 7400SM-22	
7407H	
7409M-3, 7409M-4, 7409M-5, 7409M-6, 7409M-7, 7409M-8, 7409M-10	
7409TORX-T25, 7409TORX-T27, 7409TORX-T30, 7409TORX-T40, 7409TORX-T45, 7409TORX-T50	
7750SL	
7754, 7760, 7761	
7758	
7762, 7760-3, 7760-5	
7765	
7766	
7800SM-10, 7800SM-11, 7800SM-12, 7800SM-13, 7800SM-14, 7800SM-15, 7800SM-16, 7800SM-17, 7800SM-18, 7800SM-19, 7800SM-21, 7800SM-22, 7800SM-24, 7800SM-27, 7800SM-30, 7800SM-32	

7807H	
7809M-5, 7809M-6, 7809M-7, 7809M-8, 7809M-10, 7809M-12, 7809M-14, 7809M-17, 7809M-19	
7809TORX-T20, 7809TORX-T25, 7809TORX-T27, 7809TORX-T30, 7809TORX-T40, 7809TORX-T45, 7809TORX-T55, 7809TORX-T50, 7809TORX-T60	
8150SL	
8164-1/2	
8154-11	
8160-5, 8160-10	
8171	
8166	
8172	
6960-2, 6972	
6960-4	
7771	

FF1A09 - 34 piezas



**FF1A09**

50 x 445 x 543 mm 540,62 € 1 FF1A09

111M-30, 111M-32, 111M-6, 111M-7, 111M-8, 111M-9, 111M-10, 111M-11, 111M-12, 111M-13, 111M-14, 111M-15, 111M-16, 111M-17, 111M-18, 111M-19, 111M-21, 111M-22, 111M-24, 111M-27	
1320RM-10-11, 1320RM-12-13, 1320RM-8-9	
6M-6-7, 6M-8-9, 6M-10-11, 6M-12-13, 6M-14-15, 6M-16-17, 6M-18-19, 6M-20-22, 6M-24-27, 6M-30-32	
9071C	

FF1A1004 - 19 piezas



**FF1A1004**

38 x 445 x 543 mm 148,96 € 1 FF1A1004

900T-050-150, 900T-020-100, 900T-025-100, 900T-030-100, 900T-040-150, 900T-060-200, 900T-080-200, 900T-100-200	
BE-9777B	

FF1A1011 - 12 piezas

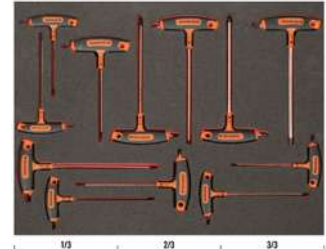

**FF1A1011**

35 x 445 x 543 mm 115,83 € 1 FF1A1011

903T-2	
903T-1	

FF1A102 - 24 piezas



**FF1A102**

40 x 445 x 543 mm 362,30 € 1 FF1A102

111M-32, 111M-8, 111M-9, 111M-10, 111M-11, 111M-12, 111M-13, 111M-14, 111M-15, 111M-16, 111M-17, 111M-18, 111M-19, 111M-21, 111M-22, 111M-24, 111M-27	
7224	
2800-180	
2900-180	
2890-180	
2990-180	
2101G-180	
2628 G-180IP	

FF1A106 - 93 piezas



**FF1A106**

	€		
55 x 543 x 445 mm	336,77	1	FF1A106

S87+7	
-------	--

FF1A11 - 13 piezas



**FF1A11**

	€		
43 x 543 x 445 mm	713,78	1	FF1A11

2101GC-125IP, 2101GC-160IP	
21HDGC-200IP	
2427 GC-200IP	
2430 GC-200 IP	
2628 GC-160IP	
2928-160, 2928-200, 2928-250	
2951-250	
2952-165	
8224CIP	
BFLA01	

FF1A110 - 11 piezas



**FF1A110**

	€		
50 x 445 x 543 mm	267,48	1	FF1A110

2535L	
426TOR9	
9572-200	
MTB-8-25	
SQZ150003	
3875-LY3	
479-24	
481-400	
529-20-L	
225-PLUS	
208	

FF1A112 - 22 piezas



**FF1A112**

	€		
35 x 445 x 543 mm	294,22	1	FF1A112

S4RM/3T	
111M-6, 111M-7, 111M-8, 111M-9, 111M-10, 111M-11, 111M-12, 111M-13, 111M-14, 111M-15, 111M-16, 111M-17, 111M-18, 111M-19, 111M-20, 111M-21, 111M-22, 111M-24, 111M-27	
9031	
9070	

FF1A114 - 18 piezas



**FF1A114**

	€		
42 x 445 x 543 mm	355,01	1	FF1A114

8224 IP	
2632	
3734-2, 3734-3, 3734-4, 3734-5, 3734-6, 3734-8	
2800-180	
2890-180	
2900-180	
2990-180	
4611-2	
479-24	
1435/5	
1178-SCRIBE	
2430 G-160 IP	
2101G-180IP	

FF1A115 - 9 piezas



**FF1A115**

	€		
35 x 445 x 543 mm	239,38	1	FF1A115

1-210-08-1-2	
9045-B-250	
406T-225	
MTB-5-25	
BFLA01	
K-AP-1	
268	
5515T-52	
319	





FF1A117 - 26 piezas



**FF1A117**

35 x 445 x 543 mm € 234,64 1 FF1A117

B191.040.100	
B190.055.125, B190.065.150	
B192.000.075, B192.001.100, B192.002.125	
111M-32, 111M-6, 111M-7, 111M-8, 111M-9, 111M-10, 111M-11, 111M-12, 111M-13, 111M-14, 111M-15, 111M-16, 111M-17, 111M-18, 111M-19, 111M-21, 111M-22, 111M-24, 111M-27	
8073 IP	

FF1A12 - 19 piezas



**FF1A12**

35 x 445 x 543 mm € 405,38 1 FF1A12

FS-8	
1-100-06-1-2, 1-100-06-2-2	
1-160-06-1-2	
1-210-06-1-2	
1-230-06-1-2	
2509	
2535F2	
3625W-35	
3734-3, 3734-5, 3734-8	
3735-4-120	
3740-150	
3745-150	
481-300, 481-500	
319	
8157-15	

FF1A121 - 28 piezas



**FF1A121**

40 x 445 x 543 mm € 346,50 1 FF1A121

111M-8, 111M-9, 111M-10, 111M-11, 111M-12, 111M-13, 111M-14, 111M-15, 111M-16, 111M-17, 111M-18, 111M-19, 111M-22	
2470 G-200	
7224	
2953-250	
6M-6-7, 6M-8-9, 6M-10-11, 6M-12-13, 6M-14-15, 6M-16-17, 6M-18-19, 6M-20-22	
2800-180	
2900-180	
2101G-160IP	

FF1A124 - 25 piezas



**FF1A124**

45 x 445 x 543 mm € 207,58 1 FF1A124

B191.040.100	
B190.055.125, B190.065.150	
B192.000.075, B192.001.100, B192.002.125	
111M-32, 111M-6, 111M-7, 111M-8, 111M-9, 111M-10, 111M-11, 111M-12, 111M-13, 111M-14, 111M-15, 111M-16, 111M-17, 111M-18, 111M-19, 111M-21, 111M-22, 111M-24, 111M-27	

FF1A127 - 11 piezas

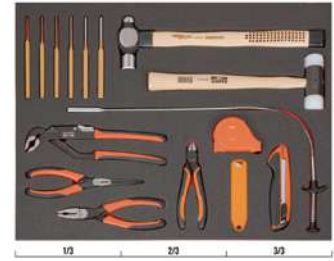

**FF1A127**

35 x 445 x 543 mm € 256,41 1 FF1A127

3734S/6	
479-16	
3625W-35	
MTG-3-16	
KB18-01	
KSBG18-10DISPEN	
8224 IP	
2101G-160IP	
2628 G-180IP	
2430 G-200 IP	
2530	

FF1A13 - 83 piezas



**FF1A13**

55 x 445 x 543 mm € 1.619,82 1 FF1A13

A6700DZ-1/2, A6700DZ-1/4, A6700DZ-11/32, A6700DZ-3/16, A6700DZ-3/8, A6700DZ-5/16, A6700DZ-7/16, A6700DZ-7/32, A6700DZ-9/16, A6700DZ-9/32	
A6710DZ-1/2, A6710DZ-1/4, A6710DZ-11/32, A6710DZ-3/16, A6710DZ-3/8, A6710DZ-5/16, A6710DZ-7/16, A6710DZ-7/32, A6710DZ-9/16, A6710DZ-9/32	
A6800DM-4, A6800DM-10	
A6800DZ-1/2, A6800DZ-1/4, A6800DZ-11/32, A6800DZ-3/16, A6800DZ-3/8, A6800DZ-5/16, A6800DZ-7/16, A6800DZ-7/32, A6800DZ-9/16, A6800DZ-9/32	

A7400DZ-1/2, A7400DZ-1/4, A7400DZ-11/16, A7400DZ-13/16, A7400DZ-17/32, A7400DZ-19/32, A7400DZ-3/4, A7400DZ-3/8, A7400DZ-5/16, A7400DZ-5/8, A7400DZ-7/16, A7400DZ-7/8, A7400DZ-9/16	
A7402DZ-1/2, A7402DZ-1/4, A7402DZ-11/16, A7402DZ-13/16, A7402DZ-19/32, A7402DZ-3/4, A7402DZ-3/8, A7402DZ-5/8, A7402DZ-7/16, A7402DZ-7/8, A7402DZ-9/16	
6700SZ-5/32	
6950SL	
6954, 7764	
6956	
6958	
6960, 6961, 6962, 6962L, 6960-6, 6960-14	
6966	
6972H	
7407H, 7408H	
7750SL	
7752	
7754, 7760, 7761	
7758	
7762, 7760-3, 7760-5	
7765	
7766	
8164-1/2	
U-S6106KA, 6960-4	
8171	
6960-2, 6972	
7771	

### FF1A130 - 53 piezas



### FF1A130

45 x 445 x 543 mm 732,59 1 FF1A130

7800SM-8, 7800SM-9, 7800SM-10, 7800SM-11, 7800SM-12, 7800SM-13, 7800SM-14, 7800SM-15, 7800SM-16, 7800SM-17, 7800SM-18, 7800SM-19, 7800SM-21, 7800SM-22, 7800SM-23, 7800SM-24, 7800SM-27, 7800SM-30, 7800SM-32	
8150SL	
SBS87S, SBS87, 8158-10, 8158-15	
SBS83-3, SBS83-5, SBS83-10	
SBS85	
SBS86	
SBS88	
SBS89	

7809TORX-T20, 7809TORX-T25, 7809TORX-T27, 7809TORX-T30, 7809TORX-T40, 7809TORX-T45, 7809TORX-T50, 7809TORX-T55, 7809TORX-T60	
7809M-5, 7809M-6, 7809M-7, 7809M-8, 7809M-9, 7809M-10, 7809M-12, 7809M-14, 7809M-17, 7809M-19	
7809M-5-180, 7809M-6-140, 7809M-7-100, 7809M-8-120, 7809M-10-140	

### FF1A131 - 25 piezas



### FF1A131

40 x 445 x 543 mm 268,61 1 FF1A131

SQZ150003	
FS-8	
SQZ150003-SBL	
481-400	
3734-2, 3734-4, 3734-5, 3734-6, 3734-8, 3734-3	
3735-5-120	
3740-175	
BE-9678	
1547	
319	
208	
3625N-32	

### FF1A132 - 31 piezas



### FF1A132

40 x 445 x 543 mm 396,83 1 FF1A132

7400SM-6, 7400SM-7, 7400SM-8, 7400SM-9, 7400SM-10, 7400SM-11, 7400SM-12, 7400SM-13, 7400SM-14, 7400SM-15, 7400SM-16, 7400SM-17, 7400SM-18, 7400SM-19	
--	--

7750SL	
SBS705	
SBS755	
SBS723, SBS724	
SBS775	
SBS760, SBS761, SBS762	
1-100-08-1-2	
1-160-08-1-2	
1-170-08-2-2	
1-210-08-1-2	
1-230-08-1-2	
2635	
1150D	
2681	

### FF1A133 - 17 piezas



### FF1A133

35 x 445 x 543 mm 158,72 1 FF1A133

900T-020-100, 900T-025-100, 900T-030-100, 900T-040-150, 900T-050-150, 900T-060-200, 900T-080-200, 900T-100-200	
B194.006.075, B194.007.075, B194.008.075, B194.009.075, B194.010.075, B194.015.100, B194.020.100, B194.025.125, B194.030.150	

### FF1A134 - 21 piezas



### FF1A134

37 x 445 x 543 mm 219,78 1 FF1A134

111M-30, 111M-32, 111M-6, 111M-7, 111M-8, 111M-9, 111M-10, 111M-11, 111M-12, 111M-13, 111M-14, 111M-15, 111M-16, 111M-17, 111M-18, 111M-19, 111M-20, 111M-21, 111M-22, 111M-24, 111M-27	
---	--





FF1A135 - 51 piezas



**FF1A135**

	€		
40 x 445 x 543 mm	671,54	1	FF1A135

4040M-8-9, 4040M-10-11, 4040M-12-13, 4040M-14-15, 4040M-16-17, 4040M-18-19, 4040M-20-22, 4040M-21-23	
59S/31-1	
6M-6-7, 6M-8-9, 6M-10-11, 6M-12-13, 6M-14-15, 6M-16-17, 6M-18-19, 6M-20-22, 6M-21-23, 6M-24-27, 6M-25-28, 6M-30-32	

FF1A136 - 39 piezas



**FF1A136**

	€		
40 x 445 x 543 mm	451,77	1	FF1A136

2628 G-180	
2430 G-160	
8224	
2101G-160	
6700SM-4.5, 6700SM-5, 6700SM-5.5, 6700SM-6, 6700SM-7, 6700SM-8, 6700SM-9, 6700SM-10, 6700SM-11, 6700SM-12, 6700SM-13, 6700SM-14, 6700SM-4	
6950SL	
SBS67	
SBS69	
SBS65	
SBS69	

SBS65	
SBS63-2, SBS63-4, SBS63-6	
2800-180	
2890-180	
2900-180	
2990-180	
B191.030.075, B191.040.100	
B190.055.100, B190.065.125, B190.080.150	
B195.050.025	
B195.001.025	
B192.001.100, B192.002.125	
808050	
6954	

FF1A137 - 59 piezas



**FF1A137**

	€		
50 x 445 x 543 mm	671,54	1	FF1A137

7800SM-8, 7800SM-9, 7800SM-10, 7800SM-11, 7800SM-12, 7800SM-13, 7800SM-14, 7800SM-15, 7800SM-16, 7800SM-17, 7800SM-18, 7800SM-19, 7800SM-21, 7800SM-22, 7800SM-23, 7800SM-24, 7800SM-27, 7800SM-30, 7800SM-32	
8150SL	
SBS87S, SBS87, 8158-10, 8158-15	
SBS83-3, SBS83-5, SBS83-10	
SBS85	
SBS86, 6954	
SBS88	
SBS89	
7809TORX-T50, 7809TORX-T20, 7809TORX-T25, 7809TORX-T27, 7809TORX-T30, 7809TORX-T40, 7809TORX-T45, 7809TORX-T55, 7809TORX-T60	
6700SM-4, 6700SM-4.5, 6700SM-5, 6700SM-5.5, 6700SM-6, 6700SM-7, 6700SM-8, 6700SM-9, 6700SM-10, 6700SM-11, 6700SM-12, 6700SM-13, 6700SM-14	
6950SL	
SBS67	
SBS69	
SBS65	
SBS63-2, SBS63-4, SBS63-6	

FF1A138 - 24 piezas



**FF1A138**

	€		
40 x 445 x 543 mm	262,52	1	FF1A138

SQZ150003	
FS-8	
SQZ150003-SBL	
481-400	
3734-2, 3734-3, 3734-4, 3734-5, 3734-6, 3734-8	
3735-5-120	
3740-175	
BE-9678	
319	
208	
3625N-32	

FF1A139 - 18 piezas



**FF1A139**

	€		
38 x 445 x 543 mm	195,36	1	FF1A139

808050	
900T-020-100, 900T-025-100, 900T-030-100, 900T-040-150, 900T-050-150, 900T-060-200, 900T-080-200, 900T-100-200	
B191.030.075, B191.040.100	
B190.055.100, B190.065.125, B190.080.150	
B195.050.025	
B195.001.025	
B192.001.100, B192.002.125	

FF1A14 - 43 piezas



**FF1A14**

46 x 445 x 543 mm € 716,47 1 FF1A14

111Z-1, 111Z-1/2, 111Z-1/4, 111Z-11/16, 111Z-13/16, 111Z-15/16, 111Z-3/4, 111Z-3/8, 111Z-5/16, 111Z-5/8, 111Z-7/16, 111Z-7/8, 111Z-9/16	
1320RZ-1/2-9/16, 1320RZ-1/4-5/16, 1320RZ-3/8-7/16, 1320RZ-5/16-11/32	
1931Z-1/2, 1931Z-1/4, 1931Z-11/32, 1931Z-3/16, 1931Z-3/8, 1931Z-5/16, 1931Z-5/32, 1931Z-7/16, 1931Z-7/32, 1931Z-9/16, 1931Z-9/32	
1950MZ-3/8	
1952Z-11/32	
6Z-1.1/16-1.1/4, 6Z-1-1.1/8, 6Z-1/2-9/16, 6Z-1/4-5/16, 6Z-15/16-1, 6Z-19/32-11/16, 6Z-25/32-13/16, 6Z-3/8-7/16, 6Z-5/16-11/32, 6Z-5/8-3/4, 6Z-7/8-15/16	
8069 C IP	
9070C	

FF1A141 - 47 piezas

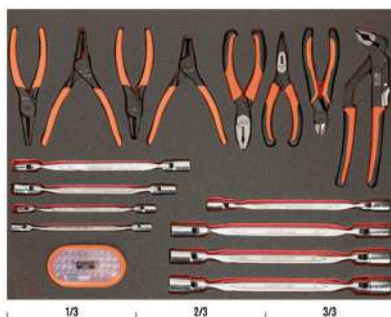

**FF1A141**

42 x 445 x 543 mm € 757,01 1 FF1A141

2628 G-180	
2430 G-160	
8224	
2101G-160	
2800-180	

2890-180	
2900-180	
2990-180	
4040M-8-9, 4040M-10-11, 4040M-12-13, 4040M-14-15, 4040M-16-17, 4040M-18-19, 4040M-20-22, 4040M-21-23	
59S/31-1	

FF1A143 - 16 piezas



**FF1A143**

45 x 445 x 543 mm € 262,52 1 FF1A143

SQZ150003	
FS-8	
SQZ150003-SBL	
MTB-5-25	
481-400	
3734-2, 3734-3, 3734-4, 3734-5, 3734-6, 3734-8	
3735-5-120	
3740-175	
319	
208	
3625N-32	

FF1A145 - 20 piezas



**FF1A145**

38 x 445 x 543 mm € 311,35 1 FF1A145

2628 G-180	
2430 G-160	
8224	
2101G-160	
8045LVDE	
808050	
613-3-75	
611-4-100, 611-5.5-100, 611-6.5-150, 611-8-150, 611-6.5-25	
615-1-100, 615-2-125, 615-2-25	
1-100-08-1-2	
1-160-08-1-2	
1-170-08-2-2	
1-210-08-1-2	
1-230-08-1-2	

FF1A146 - 34 piezas



**FF1A146**

50 x 445 x 543 mm € 634,90 1 FF1A146

2628 G-180	
2430 G-160	
8224	
2101G-160	
FS-8	
7800SM-8, 7800SM-9, 7800SM-10, 7800SM-11, 7800SM-12, 7800SM-13, 7800SM-14, 7800SM-15, 7800SM-16, 7800SM-17, 7800SM-18, 7800SM-19, 7800SM-21, 7800SM-22, 7800SM-23, 7800SM-24, 7800SM-27, 7800SM-30, 7800SM-32	
8150SL	
SBS87S, SBS87, 8158-10, 8158-15	
8160-3, 8160-5, 8160-10	
8166	
8154-11	
8171	
8172	



FF1A15 - 12 piezas



**FF1A15**

	€		
40 x 445 x 543 mm	791,35	1	FF1A15

2101GC-125IP, 2101GC-160IP	
2233D-240IP	
2421GC-180IP	
2427 GC-200IP	
2430 GC-200 IP	
2628 GC-160IP	
2650	
2855, 2855 D	
2951-180	
8224CIP	

FF1A153, 94 piezas



**FF1A153**

	€		
335 x 445 x 543 mm	364,73	1	FF1A153

S87+7	
-------	--

FF1A16 - 18 piezas



**FF1A16**

	€		
40 x 445 x 543 mm	577,22	1	FF1A16

KE18-01	
1150-1/2H/P	
MTB-3-16	
1177-SCRIBE	
1544	
2509	
2535F2	
2632	
268	
2744	
2820EF2	
3525HB	
5471 F-145	
5515T	
5515T-52	
5516	
BFLA01	
SR300-E	

FF1A168, 36 piezas



**FF1A168**

	€		
40 x 445 x 543 mm	226,59	1	FF1A168

1-100-08-2-2	
1-210-08-2-2	
1-230-08-2-2	

2485	
2487	
319	
268	
3740-100, 3740-150	
5515T	
782-U	
7865	
KB18-01	
KSBG18-10DISPEN	

FF1A170- 14 piezas



**FF1A170**

	€		
40 x 445 x 543 mm	295,03	1	FF1A170

28M-16, 28M-15, 28M-18, 28M-17, 28M-12, 28M-11, 28M-14, 28M-13, 28M-24, 28M-19, 28M-22, 28M-8, 28M-10, 28M-9	
--	--

FF1A18 - 26 piezas



**FF1A18**

	€		
44 x 445 x 543 mm	333,72	1	FF1A18

1-476-04-3-2	
2633/S4	
3734S/6	
3736S/6	
481-200, 481-500	
782-U	
3625N-32	



Foam Fit&Go 3/3 con htas. para golpeo, corte y alicates -14 piezas



### FF1A185

	€		
40 x 445 x 543 mm	185,66	1	FF1A185

3734S/6-T	
479-16	
3625W-35	
KB18-01	
KSBG18-10DISPEN	
2101G-180IP	
2470 G-200	
2678 G-180	
8224 IP	
2530	

### FF1A19 - 33 piezas



### FF1A19

	€		
50 x 543 x 445 mm	466,77	1	FF1A19

111M-30, 111M-32, 111M-6, 111M-7, 111M-8, 111M-9, 111M-10, 111M-11, 111M-12, 111M-13, 111M-14, 111M-15, 111M-16, 111M-17, 111M-18, 111M-19, 111M-20, 111M-21, 111M-22, 111M-24, 111M-27	
6M-6-7, 6M-8-9, 6M-10-11, 6M-12-13, 6M-14-15, 6M-16-17, 6M-18-19, 6M-20-22, 6M-21-23, 6M-24-27, 6M-30-32	
92C	

Incluye 51 piezas



### FF1A194

	€		
40 x 445 x 543 mm	696,29	1	FF1A194

6968	
6700SM-14, 6700SM-13, 6700SM-12, 6700SM-11, 6700SM-10, 6700SM-9, 6700SM-8, 6700SM-7, 6700SM-6, 6700SM-5, 6700SM-4	
6709M-3, 6709M-8, 6709M-6, 6709M-5, 6709M-4	
6950SL	
7800SM-24, 7800SM-23, 7800SM-22, 7800SM-13, 7800SM-12, 7800SM-11, 7800SM-10, 7800SM-9, 7800SM-8, 7800SM-21, 7800SM-19, 7800SM-18, 7800SM-17, 7800SM-16, 7800SM-15, 7800SM-14	
7809M-8, 7809M-7, 7809M-10, 7809M-6, 7809M-5	
7809TORX-T20, 7809TORX-T25, 7809TORX-T30, 7809TORX-T40	
7455-200	
8150SL	
8168	
K6650-1/4-1P	
6960W-2, 6960W-6	
8160-10, 8160-5	

### FF1A20 - 18 piezas



### FF1A20

	€		
50 x 445 x 543 mm	524,96	1	FF1A20

2M-6-7, 2M-8-9, 2M-10-11, 2M-12-13, 2M-14-15, 2M-16-17, 2M-18-19, 2M-20-22, 2M-21-23, 2M-24-27, 2M-30-32	
4040M-10-11, 4040M-12-13, 4040M-14-15, 4040M-16-17, 4040M-18-19, 4040M-21-23	
2953-250	

### FF1A22 - 58 piezas



### FF1A22

	€		
50 x 445 x 543 mm	862,83	1	FF1A22

7800SM-10, 7800SM-12, 7800SM-13, 7800SM-14, 7800SM-16, 7800SM-17, 7800SM-18, 7800SM-19, 7800SM-21, 7800SM-22, 7800SM-23, 7800SM-24, 7800SM-27, 7800SM-30, 7800SM-32	
7805SM-13, 7805SM-16, 7805SM-17, 7805SM-18, 7805SM-19, 7805SM-21, 7805SM-22, 7805SM-24, 7805SM-27, 7805SM-30, 7805SM-32	
7809M-5, 7809M-6, 7809M-8, 7809M-10, 7809M-12, 7809M-14	
8150SL	
6700SM-4, 6700SM-4.5, 6700SM-5, 6700SM-5.5, 6700SM-6, 6700SM-7, 6700SM-8, 6700SM-9, 6700SM-10, 6700SM-11, 6700SM-12, 6700SM-13	
6958	
6954	
6960, 6962, 6960-6	
6966	
6950SL	
4532-A	
8157-15	
8154-11	
8160-3, 8160-5	
8166	
6960-2	



FF1A23 - 21 piezas



**FF1A23**

	€		
40 x 445 x 543 mm	478,23	1	FF1A23

3735-4-120	
3734-2, 3734-3, 3734-4, 3734-5, 3734-6, 3734-8	
2630GC-180IP	
2430 GC-200 IP	
2427 GC-200IP	
2900-180	
2890-180	
2990-180	
2800-180	
7224	
2101GC-160IP	
479-16	
1547	
MTB-3-16	
SC127	
3625N-32	

Incluye 17 piezas



**FF1A230**

	€		
40 x 445 x 543 mm	526,14	1	FF1A230

1RM-9, 1RM-8, 1RM-11, 1RM-10, 1RM-13, 1RM-12, 1RM-15, 1RM-14, 1RM-17, 1RM-16, 1RM-19, 1RM-18	
28-29/S4	
8072 C	

FF1A2301 - 26 piezas



**FF1A2301**

	€		
70 x 445 x 543 mm	823,74	1	FF1A2301

8900DM-19, 8900DM-22, 8900DM-23, 8900DM-24, 8900DM-25, 8900DM-26, 8900DM-27, 8900DM-28, 8900DM-29, 8900DM-30, 8900DM-32, 8900DM-33, 8900DM-34, 8900DM-36, 8900DM-41, 8900DM-46, 8900DM-50, 8900DM-55, 8900DM-60	
8954, 8954-15	
8954A	
8958A	
8961	
8965, 8971	
8966	
8955N/B	
8957A	
8960-8	

Foam 3/3 Fut&Go para ai



**FF1A235**

	kg	€		
50 x 445 x 543 mm	4.10 kg	443,65	1	FF1A235

BE61110	
BE621702, BE621703, BE621701, BE621706, BE621707, BE621704, BE621705, BE621710, BE621711, BE621708, BE621709, BE621714, BE621715, BE621712, BE621713, BE621716, BE621717	
BE6810	
2M-6-7, 2M-8-9, 2M-12-13, 2M-18-19, 2M-16-17, 2M-10-11, 2M-14-15, 2M-24-26, 2M-21-23, 2M-27-29, 2M-20-22, 2M-30-32	

Foam Fit & Go 3/3 para carrocería de automoción - 13 piezas



**FF1A236**

	kg	€		
55 x 445 x 543 mm	9.5 kg	466,80	1	FF1A236

3-330-14-2-0	
9-462-14-0-0	
1467-250	
BBSH2F	
BBSH2CA	
BBSDW	
BBSDA	
BBSDT	
BBSDH	
BBSDC	
BBSDHR	
BBSS1	
2485	

FF1A24 - 19 piezas



**FF1A24**

	€		
45 x 445 x 543 mm	423,45	1	FF1A24

3735-4-120	
3734-2, 3734-3, 3734-4, 3734-5, 3734-6, 3734-8	
2630GC-180IP	
2430 GC-200 IP	
2900-180	
2890-180	
2990-180	
2800-180	
7224	
2101GC-160IP	



479-16	
3625N-32	
MTB-3-16	
SC127	

FF1A25 - 50 piezas



**FF1A25**

	€		
50 x 445 x 543 mm	669,15	1	FF1A25

7800SM-10, 7800SM-12, 7800SM-13, 7800SM-14, 7800SM-15, 7800SM-16, 7800SM-17, 7800SM-18, 7800SM-19, 7800SM-21, 7800SM-22, 7800SM-23, 7800SM-24, 7800SM-27, 7800SM-30, 7800SM-32		
7805SM-13, 7805SM-16, 7805SM-17, 7805SM-18, 7805SM-19, 7805SM-21, 7805SM-22, 7805SM-24, 7805SM-27, 7805SM-30, 7805SM-32		
8150SL		
6700SM-4, 6700SM-4.5, 6700SM-5, 6700SM-5.5, 6700SM-6, 6700SM-7, 6700SM-8, 6700SM-9, 6700SM-10, 6700SM-11, 6700SM-12, 6700SM-13		
6954		
6960, 6962, 6960-6		
6966		
6950SL		
2953-250		
8166		
8154-11		
8160-3, 8160-5		
6960-2		

FF1A2501 - 83 piezas



**FF1A2501**

	€		
50 x 445 x 543 mm	1.006,08	1	FF1A2501

6700SM-4, 6700SM-5, 6700SM-5.5, 6700SM-6, 6700SM-7, 6700SM-8, 6700SM-9, 6700SM-10, 6700SM-11, 6700SM-12, 6700SM-13		
6700TORX-E8, 6700TORX-E10		
6709M-3, 6709M-4, 6709M-5, 6709M-6, 6709M-8		
6709TORX-T8, 6709TORX-T10, 6709TORX-T15, 6709TORX-T20, 6709TORX-T25, 6709TORX-T27, 6709TORX-T30, 6709TORX-T40		
6950SL		
6954, 7764		
6956		
6962, 6960-6		
6966		
7400SM-8, 7400SM-9, 7400SM-10, 7400SM-11, 7400SM-12, 7400SM-13, 7400SM-14, 7400SM-15, 7400SM-16, 7400SM-17, 7400SM-18, 7400SM-19, 7400SM-20, 7400SM-21, 7400SM-22		
7400TORX-E8, 7400TORX-E10, 7400TORX-E12, 7400TORX-E14		
7750SL		
7754		
7762		
7765		
7766		
7768		
7800SM-13, 7800SM-17, 7800SM-12, 7800SM-18, 7800SM-19, 7800SM-20, 7800SM-27, 7800SM-30, 7800SM-32, 7800SM-21, 7800SM-22, 7800SM-24		
7809M-12, 7809M-10		
7809TORX-T20, 7809TORX-T25, 7809TORX-T40, 7809TORX-T50, 7809TORX-T55		
8150SL		
8164-1/2		
8154-11		
8160-10		
8171		
8166		
8172		
7771		
6972		

FF1A2503 - 101 piezas



**FF1A2503**

	€		
55 x 445 x 543 mm	702,06	1	FF1A2503

6700SM-4.5, 6700SM-4, 6700SM-5, 6700SM-5.5, 6700SM-6, 6700SM-7, 6700SM-8, 6700SM-9, 6700SM-10, 6700SM-11, 6700SM-12, 6700SM-13, 6700SM-14		
7800SM-10, 7800SM-11, 7800SM-12, 7800SM-13, 7800SM-14, 7800SM-15, 7800SM-18, 7800SM-19, 7800SM-21, 7800SM-22, 7800SM-23, 7800SM-24, 7800SM-30, 7800SM-26, 7800SM-27, 7800SM-28, 7800SM-32, 7800SM-16, 7800SM-17, 7800SM-8, 7800SM-9		
BE-9678		
7809M-10, 7809M-12, 7809M-14, 7809M-17, 7809M-19, 7809M-5, 7809M-7, 7809M-8, 7809M-9, 7809M-6		
59S/31-1		
7809M-10-140, 7809M-5-180, 7809M-6-140, 7809M-7-100, 7809M-8-120		
808050		
8155-1/2		
6950		
6954		
6956		
6960, 6962, 6960-6		
6966		
8154-11		
8160-5, 8160-10		
8166		
6960-2		

FF1A26 - 27 piezas



**FF1A26**

	€		
50 x 445 x 543 mm	483,73	1	FF1A26

111M-30, 111M-32, 111M-6, 111M-7, 111M-8, 111M-9, 111M-10, 111M-11, 111M-12, 111M-13, 111M-14, 111M-15, 111M-16, 111M-17, 111M-18, 111M-19, 111M-20, 111M-21, 111M-22, 111M-24, 111M-27		
2630GC-180IP		
2430 GC-200 IP		
7224		
2953-250		
2101GC-160IP		
SC127		



FF1A28 - 48 piezas



**FF1A28**

	€		
50 x 445 x 543 mm	566,97	1	FF1A28

7800SM-18, 7800SM-19, 7800SM-21, 7800SM-22, 7800SM-23, 7800SM-24, 7800SM-27, 7800SM-30, 7800SM-32, 7800SM-10, 7800SM-12, 7800SM-13, 7800SM-14, 7800SM-15, 7800SM-16, 7800SM-17		
8150SL		
6700SM-4.5, 6700SM-5, 6700SM-5.5, 6700SM-6, 6700SM-7, 6700SM-8, 6700SM-9, 6700SM-10, 6700SM-11, 6700SM-12, 6700SM-13, 6700SM-4		
6954		
6960, 6962, 6960-6		
6966		
6950SL		
3735-4-120		
3734-2, 3734-3, 3734-4, 3734-5, 3734-6, 3734-8		
479-16		
MTB-3-16		
3625N-32		
8154-11		
8160-3, 8160-5		
8166		
6960-2		

FF1A3001 - 21 piezas



**FF1A3001**

	€		
40 x 445 x 543 mm	282,14	1	FF1A3001

111M-32, 111M-30, 111M-24, 111M-22, 111M-27, 111M-17, 111M-16, 111M-15, 111M-14, 111M-21, 111M-20, 111M-19, 111M-18, 111M-9, 111M-8, 111M-7, 111M-6, 111M-13, 111M-12, 111M-11, 111M-10		
---	--	--

FF1A3002 - 7 piezas



**FF1A3002**

	€		
35 x 445 x 543 mm	357,75	1	FF1A3002

1RM-24, 1RM-22, 1RM-21, 1RM-19, 1RM-32, 1RM-30, 1RM-27		
--	--	--

FF1A3003 - 28 piezas



**FF1A3003**

	€		
40 x 445 x 543 mm	316,92	1	FF1A3003

1952M-27, 1952M-21, 1952M-20, 1952M-19, 1952M-18, 1952M-24, 1952M-22, 1952M-13, 1952M-12, 1952M-11, 1952M-10, 1952M-17, 1952M-16, 1952M-15, 1952M-14, 1952M-9, 1952M-8, 1952M-7, 1952M-6		
--	--	--

BE-9778		
---------	--	--

FF1A3004 - 30 piezas



**FF1A3004**

	€		
48 x 445 x 543 mm	551,88	1	FF1A3004

111M-24, 111M-22, 111M-17, 111M-16, 111M-15, 111M-14, 111M-21, 111M-20, 111M-19, 111M-18, 111M-9, 111M-8, 111M-7, 111M-6, 111M-13, 111M-12, 111M-11, 111M-10		
--	--	--

1RM-19, 1RM-10, 1RM-9, 1RM-8, 1RM-14, 1RM-13, 1RM-12, 1RM-11, 1RM-18, 1RM-17, 1RM-16, 1RM-15		
--	--	--

FF1A3005 - 28 piezas



**FF1A3005**

	€		
38 x 445 x 543 mm	586,07	1	FF1A3005

1952M-19, 1952M-18, 1952M-22, 1952M-13, 1952M-12, 1952M-11, 1952M-10, 1952M-17, 1952M-16, 1952M-15, 1952M-14, 1952M-9, 1952M-8, 1952M-7, 1952M-6		
--	--	--

1RM-6, 1RM-10, 1RM-9, 1RM-8, 1RM-7, 1RM-24, 1RM-22, 1RM-19, 1RM-14, 1RM-13, 1RM-12, 1RM-11, 1RM-17		
--	--	--

FF1A36 - 89 piezas



**FF1A36**

	€		
50 x 445 x 543 mm	498,47	1	FF1A36

4040M-8-9, 4040M-10-11, 4040M-12-13, 4040M-14-15, 4040M-16-17		
---	--	--

808050S		
---------	--	--

808050		
--------	--	--

6972H		
-------	--	--

K6650-1/4-1P, 59S/H8, SB6963		
------------------------------	--	--

6950SL		
--------	--	--

59S/31-1		
----------	--	--

59S/H2, 59S/H3, 59S/H4, 59S/H5, 59S/H6		
--	--	--

8030-2P, 8040-2P, 8242-2P, 8252-2P		
8610-2P, 8620-2P, 8630-2P		
8810-2P, 8820-2P, 8830-2P		
8910-2P, 8915-2P, 8925-2P, 8930-2P, 8940-2P		
BE-8575		
SBS60-11, SBS60-12, SBS60-13, SBS60-4, SBS60-4.5, SBS60-5, SBS60-5.5, SBS60-6, SBS60-7, SBS60-8, SBS60-9, SBS60-10		
SBS64		

2421 G-140IP, 2421 G-180 IP		
2427 G-200 IP		
2628 G-180IP		
2681		
2951-140, 2951-300		
8224 IP		

Llaves, 31 piezas



FF1A37 - 46 piezas



FF1A37

	€		
35 x 445 x 543 mm	363,52	1	FF1A37

FF1A4002 - 11 piezas



FF1A4002

	€		
42 x 445 x 543 mm	400,21	1	FF1A4002

111M-6, 111M-7, 111M-8, 111M-9, 111M-10, 111M-11, 111M-12, 111M-13, 111M-14, 111M-15, 111M-16, 111M-17, 111M-18, 111M-19, 111M-21, 111M-22, 111M-24		
8071 IP		
2101G-160		
2430 G-160		
8224		
S240NB-NR		
8150SL		

2101G-160IP		
2430 G-200 IP		
2465D-200		
2628 G-160IP		
2744		
2951-140		
2952-165		
1520 G		
527 D-160		
7224		
5515FL		

FF1A48

	€		
44 x 543 x 445 mm	382,68	1	FF1A48

1RM-6, 1RM-7, 1RM-8, 1RM-9, 1RM-10, 1RM-11, 1RM-12, 1RM-13, 1RM-14, 1RM-17, 1RM-19, 1RM-22, 1RM-24, 1RM-27		
--	--	--

111M-6, 111M-7, 111M-8, 111M-9, 111M-10, 111M-11, 111M-12, 111M-13, 111M-14, 111M-15, 111M-16, 111M-17, 111M-18, 111M-19, 111M-20, 111M-21, 111M-22		
---	--	--

FF1A4001 - 12 piezas



FF1A4001

	€		
38 x 445 x 543 mm	445,68	1	FF1A4001

FF1A4003 - 12 piezas



FF1A4003

	€		
35 x 445 x 543 mm	325,97	1	FF1A4003

1520 D		
2101G-160IP		
21HDG-200IP		
2223 G-150		

2800-150, 2800-180, 2800-225		
2890-140, 2890-180, 2890-210		
2900-150, 2900-180, 2900-215		
2990-140, 2990-180, 2990-200		

FF1A50 - 13 piezas



FF1A50

	€		
45 x 445 x 543 mm	545,05	1	FF1A50

8223 IP, 8224 IP, 8225 IP		
1420		
2430 G-160 IP		
2427 G-160 IP		
8069		
9070		
9031		
2101G-160IP		
21HDG-180IP		





FF1A5002 - 27 piezas



**FF1A5002**

	€		
50 x 445 x 543 mm	337,23	1	FF1A5002

111M-30, 111M-32, 111M-6, 111M-7, 111M-8, 111M-9, 111M-10, 111M-11, 111M-12, 111M-13, 111M-14, 111M-15, 111M-16, 111M-17, 111M-18, 111M-19, 111M-20, 111M-21, 111M-22, 111M-24, 111M-27	
---	--

3734S/6	
---------	--

FF1A5003 - 91 piezas



**FF1A5003**

	€		
45 x 445 x 543 mm	1.064,04	1	FF1A5003

111M-13, 111M-12, 111M-10, 111M-8, 111M-19, 111M-17, 111M-15	
--	--

6700SM-5.5, 6700SM-5, 6700SM-14, 6700SM-13, 6700SM-12, 6700SM-11, 6700SM-10, 6700SM-9, 6700SM-8, 6700SM-7, 6700SM-6	
---	--

6700TORX-E5, 6700TORX-E4, 6700TORX-E10, 6700TORX-E8, 6700TORX-E7, 6700TORX-E6	
---	--

6709TORX-T27, 6709TORX-T25, 6709TORX-T20, 6709TORX-T15, 6709TORX-T10, 6709TORX-T9, 6709TORX-T8, 6709TORX-T40, 6709TORX-T30	
--	--

6950	
------	--

6961, 6962, 6960-6	
--------------------	--

6966	
------	--

7400SM-13, 7400SM-12, 7400SM-11, 7400SM-10, 7400SM-9, 7400SM-8, 7400SM-21, 7400SM-19, 7400SM-18, 7400SM-17, 7400SM-16, 7400SM-15, 7400SM-14, 7400SM-22	
--	--

7400TORX-E18, 7400TORX-E16, 7400TORX-E14, 7400TORX-E12, 7400TORX-E11, 7400TORX-E10, 7400TORX-E8	
---	--

7409TORX-T30, 7409TORX-T27, 7409TORX-T25, 7409TORX-T50, 7409TORX-T45, 7409TORX-T40	
--	--

7750	
------	--

7760, 7761	
------------	--

7762, 7760-3, 7760-5	
----------------------	--

7764	
------	--

7765	
------	--

7766	
------	--

A6800DM-8, A6800DM-7, A6800DM-6, A6800DM-14, A6800DM-13, A6800DM-12, A6800DM-11, A6800DM-10, A6800DM-9	
--	--

A7402DM-19, A7402DM-18, A7402DM-17, A7402DM-16, A7402DM-15, A7402DM-14, A7402DM-13, A7402DM-12, A7402DM-11, A7402DM-10	
--	--

8157-15	
---------	--

6960-4	
--------	--

7771	
------	--

6972	
------	--

FF1A5004 - 37 piezas



**FF1A5004**

	€		
55 x 445 x 543 mm	757,01	1	FF1A5004

1RM-19, 1RM-13, 1RM-12, 1RM-11, 1RM-10, 1RM-9, 1RM-8, 1RM-27, 1RM-7, 1RM-24, 1RM-6, 1RM-22, 1RM-17	
--	--

6700SM-13, 6700SM-12, 6700SM-11, 6700SM-10, 6700SM-9, 6700SM-8, 6700SM-7, 6700SM-6	
--	--

6950	
------	--

6960	
------	--

6966	
------	--

7800SM-19, 7800SM-17, 7800SM-32, 7800SM-30, 7800SM-13, 7800SM-27, 7800SM-24, 7800SM-22	
--	--

8155-1/2	
----------	--

SBS86, 6954	
-------------	--

8160-5	
--------	--

8166	
------	--

6960-2	
--------	--

FF1A5005 - 83 piezas



**FF1A5005**

	€		
50 x 445 x 543 mm	1.050,04	1	FF1A5005

111M-17, 111M-15, 111M-13, 111M-19, 111M-8	
--	--

6700SM-8, 6700SM-7, 6700SM-6, 6700SM-12, 6700SM-11, 6700SM-10, 6700SM-9, 6700SM-14, 6700SM-13, 6700SM-5, 6700SM-4	
---	--

6709M-5, 6709M-4, 6709M-8, 6709M-6, 6709M-3	
---	--

6950SL	
--------	--

6962, 6960-6	
--------------	--

6968	
------	--

7400SM-8, 7400SM-7, 7400SM-6, 7400SM-12, 7400SM-11, 7400SM-10, 7400SM-9, 7400SM-16, 7400SM-15, 7400SM-14, 7400SM-13, 7400SM-18, 7400SM-17	
---	--

7750SL	
--------	--

7760-W	
--------	--

7761	
------	--

7768	
------	--

7800SM-11, 7800SM-10, 7800SM-15, 7800SM-14, 7800SM-13, 7800SM-12, 7800SM-19, 7800SM-18, 7800SM-17, 7800SM-16, 7800SM-22, 7800SM-21, 7800SM-27, 7800SM-24, 7800SM-32, 7800SM-30, 7800SM-8, 7800SM-9	
--	--

7809M-17, 7809M-14, 7809M-12, 7809M-10, 7809M-5, 7809M-6, 7809M-7, 7809M-8	
--	--

7809TORX-T40, 7809TORX-T30, 7809TORX-T25, 7809TORX-T20, 7809TORX-T45	
--	--

8150SL	
--------	--

A6709M-6, A6709M-5, A6709M-4, A6709M-3, A6709M-2.5	
--	--

K6650-1/4-1P	
--------------	--

6960W-2, 6960W-6, 6960-W	
--------------------------	--

8160-5, 8160-10	
-----------------	--

8166	
------	--

7760-5	
--------	--

FF1A5006 - 27 piezas













**FF1A5006**





54 x 445 x 543 mm      511,59      1      FF1A5006

1-100-08-2-2		
1-210-08-2-2		
1-230-06-2-2, 1-230-10-2-2		
111M-7, 111M-8, 111M-9, 111M-10, 111M-11, 111M-12, 111M-13, 111M-14, 111M-15, 111M-16, 111M-17, 111M-18, 111M-19, 111M-21, 111M-22		
1320RM-6-7, 1320RM-8-9, 1320RM-10-11, 1320RM-12-13, 1320RM-14-15, 1320RM-16-17, 1320RM-18-19, 1320RM-22-24		

FF1A5007 - 60 piezas









































**FF1A5007**





50 x 445 x 543 mm      768,60      1      FF1A5007

K6650-1/4-1P, 6954		
3734-2, 3734-3, 3734-4, 3734-5, 3734-6, 3734-8		
481-400		
6700SM-11, 6700SM-12, 6700SM-13, 6700SM-14, 6700SM-10, 6700SM-5, 6700SM-6, 6700SM-7, 6700SM-8, 6700SM-9, 6700SM-4		

6709F-8, 6709F-5.5		
6709M-3, 6709M-4, 6709M-5, 6709M-6		
6709PH-1, 6709PH-2		
6950SL		
6960, 6962, 6960-6		
6966		
7800SM-18, 7800SM-19, 7800SM-10, 7800SM-11, 7800SM-12, 7800SM-13, 7800SM-14, 7800SM-15, 7800SM-16, 7800SM-17, 7800SM-21, 7800SM-22, 7800SM-23, 7800SM-24, 7800SM-25, 7800SM-26, 7800SM-27, 7800SM-28, 7800SM-30, 7800SM-32		
8072 IP		
B145.006.100		
8150SL		
8224 IP		
8154-11		
8160-5, 8160-10		
8166		
6960-2		

FF1A5008 - 24 piezas



































**FF1A5008**





50 x 445 x 543 mm      565,32      1      FF1A5008

1-100-08-2-2		
1-160-08-2-2		
1-170-08-2-2		
1-210-08-2-2		
1-230-08-2-2		
1150D		
1450D-ISO		
1547		
3625N-40		
3734-2, 3734-3, 3734-4, 3734-5, 3734-6, 3734-8		
3735-4-120, 3735-5-150		
3740-125, 3740-150		
38-20		
5515T		
9029, 9031		
MTB-3-16		

FF1A5009 - 17 piezas

























**FF1A5009**





38 x 445 x 543 mm      499,39      1      FF1A5009

2101S-160		
2223 S-150		
2250V-170		
2430 S-200		
2628 S-180		
8072V		
BE-8220S, BE-8040S, BE-8050S, BE-8255S, BE-8065S		
BE-8340		
BE-8601		
BE-8610S, BE-8620S		
BE-8810S, BE-8820S		

FF1A5010 - 22 piezas

































**FF1A5010**





35 x 445 x 543 mm      358,54      1      FF1A5010

1-100-08-1-2		
1-160-08-1-2		
1-170-08-2-2		
1-210-08-1-2		
1-230-08-1-2		
2101G-180IP		
2427 G-200 IP		
2430 G-200 IP		
2628 G-180IP		
3733-2, 3733-4, 3733-6		
3734-2, 3734-3, 3734-4, 3734-5, 3734-6, 3734-8		
3735-4-120		
481-300		
8069 IP		
9031		





FF1A5011 - 27 piezas



**FF1A5011**

	€			
44 x 445 x 543 mm	360,18	1	FF1A5011	

1-476-04-3-2	
1178-SCRIBE	
1547	
2101G-160IP	
2427 G-160 IP	
2430 G-160 IP	
3734-2, 3734-3, 3734-4, 3734-5, 3734-6, 3734-8	
3735-5-120	
481-500	
BE-8020L, BE-8040	
BE-8150, BE-8255, BE-8256	
BE-8610, BE-8620	
MTB-3-16	

FF1A5012 - 13 piezas



**FF1A5012**

	€			
48 x 445 x 543 mm	278,38	1	FF1A5012	

141	
3734-2, 3734-3, 3734-4, 3734-5, 3734-6	
479-08	
481-1000, 481-300	
782-U	
MTS-5-25	
SQZ150003	
319	

FF1A5013 - 41 piezas



**FF1A5013**

	€			
50 x 445 x 543 mm	554,33	1	FF1A5013	

111M-6, 111M-7, 111M-8, 111M-9, 111M-12, 111M-13, 111M-17, 111M-10, 111M-11, 111M-19, 111M-20, 111M-22, 111M-24, 111M-27, 111M-32, 111M-30	
6700SM-6, 6700SM-7, 6700SM-8, 6700SM-9, 6700SM-10, 6700SM-11, 6700SM-12, 6700SM-13, 6700SM-14	
6950	
6960	
6966	
7800SM-19, 7800SM-17, 7800SM-13, 7800SM-22, 7800SM-27, 7800SM-24, 7800SM-30, 7800SM-32	
8155-1/2	
SBS86, 6954	
8160-5	
8166	
6960-2	

FF1A5019 - 47 piezas



**FF1A5019**

	€			
52 x 445 x 543 mm	610,48	1	FF1A5019	

111M-17, 111M-18, 111M-19, 111M-20, 111M-6, 111M-7, 111M-8, 111M-13, 111M-14, 111M-15, 111M-16, 111M-9, 111M-10, 111M-11, 111M-12	
2101G-160IP	
2430 G-160 IP	
2628 G-180IP	

7800DM-12, 7800DM-13, 7800DM-14, 7800DM-15, 7800DM-10, 7800DM-11, 7800DM-20, 7800DM-21, 7800DM-22, 7800DM-23, 7800DM-16, 7800DM-17, 7800DM-18, 7800DM-19, 7800DM-28, 7800DM-30, 7800DM-32, 7800DM-24, 7800DM-25, 7800DM-26, 7800DM-27, 7800DM-8, 7800DM-9

8155-1/2	
8224 IP	
8154-11	
8160-5, 8160-10	
8166	

FF1A5021 - 17 piezas



**FF1A5021**

	€			
45 x 445 x 543 mm	302,08	1	FF1A5021	

BE-8020L, BE-8040	
BE-8150, BE-8255, BE-8256	
BE-8340	
BE-8601	
BE-8610, BE-8620	
319	
MTB-5-25	
2444	
268	
5515T	
2509	
2744	
208	

FF1A5022 - 26 piezas



**FF1A5022**

	€			
50 x 445 x 543 mm	429,04	1	FF1A5022	

6700SM-4.5, 6700SM-5, 6700SM-5.5, 6700SM-6, 6700SM-7, 6700SM-8, 6700SM-9, 6700SM-10, 6700SM-11, 6700SM-12, 6700SM-13, 6700SM-14, 6700SM-4		
6950		
6954		
6956		
6960, 6962, 6960-6		
6966		
8070		
9031		
9072 P		
141		
2101G-160IP		
2430 G-160 IP		
2628 G-180IP		
8224 IP		
6960-2		

FF1A5023 - 16 piezas



FF1A5023

	€		
45 x 445 x 543 mm	283,12	1	FF1A5023

208		
2444		
2509		
268		
2744		
319		
5515T		
BE-8020L, BE-8040		
BE-8150, BE-8255, BE-8256		
BE-8340		
BE-8601		
BE-8610, BE-8620		

FF1A5024 - 28 piezas



FF1A5024

	€		
45 x 445 x 543 mm	654,62	1	FF1A5024

111M-12, 111M-13, 111M-6, 111M-7, 111M-8, 111M-9, 111M-10, 111M-11		
1RM-17, 1RM-18, 1RM-19, 1RM-8, 1RM-9, 1RM-10, 1RM-11, 1RM-12, 1RM-13, 1RM-14, 1RM-15, 1RM-16		
2101G-160IP		
2430 G-160 IP		
141		
2628 G-180IP		
9031		
9072 P		
8070		
8224 IP		

FF1A5028 - 33 piezas



FF1A5028

	€		
45 x 445 x 543 mm	274,72	1	FF1A5028

111M-6, 111M-7, 111M-8, 111M-9, 111M-10, 111M-11, 111M-14, 111M-15, 111M-16, 111M-17, 111M-18, 111M-19, 111M-20, 111M-12, 111M-13		
1419-MD		
BE-8906, BE-8907, BE-8908, BE-8909, BE-8910, BE-8915, BE-8920, BE-8925, BE-8927, BE-8930, BE-8940, BE-8945		
7805DM-12, 7805DM-13, 7805DM-17, 7805DM-10, 7805DM-19		

FF1A5032 - 76 piezas



FF1A5032

	€		
55 x 445 x 543 mm	695,95	1	FF1A5032

6700SM-10, 6700SM-11, 6700SM-8, 6700SM-9, 6700SM-14, 6700SM-12, 6700SM-13, 6700SM-4, 6700SM-6, 6700SM-7, 6700SM-5, 6700SM-4.5, 6700SM-5.5		
6950		
6954		
6956		
6960, 6962, 6960-6		
6966		
7400SM-6, 7400SM-7, 7400SM-10, 7400SM-11, 7400SM-8, 7400SM-9, 7400SM-14, 7400SM-15, 7400SM-12, 7400SM-13, 7400SM-18, 7400SM-19, 7400SM-16, 7400SM-17, 7400SM-22, 7400SM-20, 7400SM-21		
7754, 7760, 7761		
7755-3/8		
7762, 7760-3, 7760-5		
7766		
7800DM-11, 7800DM-14, 7800DM-15, 7800DM-12, 7800DM-13, 7800DM-18, 7800DM-19, 7800DM-16, 7800DM-17, 7800DM-22, 7800DM-23, 7800DM-20, 7800DM-21, 7800DM-26, 7800DM-27, 7800DM-24, 7800DM-30, 7800DM-32, 7800DM-28, 7800DM-8, 7800DM-9, 7800DM-10, 7800DM-25, 7800DM-29		
8155-1/2		
111M-19, 111M-17, 111M-18, 111M-15, 111M-16, 111M-14, 111M-20		
8154-11		
8160-5, 8160-10		
8166		
6960-2		



FF1A5036 - 6 piezas



**FF1A5036**

	€		
38 x 445 x 543 mm	268,61	1	FF1A5036

BE258	
BE250	
BE256P3	
BE254A	

FF1A51 - 23 piezas



**FF1A51**

	€		
40 x 445 x 543 mm	323,14	1	FF1A51

1-100-08-1-2	
1-210-08-1-2	
1-230-08-1-2	
4-144-08-2-2	
1-170-08-1-2	
3735-4-120	
3733-4, 3733-2, 3733-6	
3734-2, 3734-3, 3734-4, 3734-5, 3734-6, 3734-8	
2800-180, 2800-150	
2890-140, 2890-180	
2900-150, 2900-180	
2990-140, 2990-180	

FF1A54 - 75 piezas



**FF1A54**

	€		
35 x 445 x 543 mm	277,06	1	FF1A54

S1612L	
S0810L	
S330L	

FF1A65 - 28 piezas



**FF1A65**

	€		
50 x 445 x 543 mm	454,82	1	FF1A65

111M-19, 111M-17, 111M-18, 111M-24, 111M-21, 111M-22, 111M-7, 111M-8, 111M-6, 111M-11, 111M-12, 111M-9, 111M-10, 111M-15, 111M-16, 111M-13, 111M-14, 111M-20	
1RM-8, 1RM-9, 1RM-12, 1RM-13, 1RM-10, 1RM-11, 1RM-17, 1RM-14, 1RM-19	
319	

FF1A66 - 51 piezas



**FF1A66**

	€		
50 x 445 x 543 mm	314,03	1	FF1A66

038.055.100, 038.065.125, 038.080.150	
039.001.100, 039.002.125	
1178-SCRIBE	
426TOR9	
6972H	
9045-B-250	
BE-8010S, BE-8230S	
BE-8040	
BE-8150, BE-8155	
BE-8800, BE-8811, BE-8821	
BE-8830	
MTB-5-25	
SQZ150003	
59S/31-1	

FF1A67 - 28 piezas



**FF1A67**

	€		
39 x 445 x 543 mm	389,20	1	FF1A67

9031	
2101G-160IP	
21HDG-180IP	
2427 G-160 IP	
2430 G-160 IP	
8224 IP	
BE-8600, BE-8611, BE-8621	
BE-8630	
BE-8910, BE-8915, BE-8920, BE-8925	
7865	

FF1A68 - 30 piezas



**FF1A68**

	€		
37 x 445 x 543 mm	274,72	1	FF1A68



1-100-08-1-2	
1-170-08-1-2	
1-210-08-1-2	
1-230-08-1-2	
2800-180	
2890-180	
2900-180	
2990-180	
3733-4, 3733-2, 3733-6	
3734-8, 3734-5, 3734-6, 3734-3, 3734-4, 3734-2	
3735-4-120	
4-144-08-2-2	
481-400	
BE-9770	

FF1A70 - 105 piezas



**FF1A70**

	€	
42 x 445 x 543 mm	326,98	1 FF1A70

BE5049	
S560	

FF1A71 - 46 piezas



**FF1A71**

	€	
41 x 445 x 543 mm	201,47	1 FF1A71

901T-010-100, 901T-015-150, 901T-020-150, 901T-027-150, 901T-030-200, 901T-040-200, 901T-025-150, 901T-045-200, 901T-050-200	
--	--

B190.055.125	
B191.030.075, B191.040.100	
B192.001.100, B192.002.125	
B705.1/4.125	
59/S31B	

FF1A72 - 18 piezas



**FF1A72**

	€	
38 x 445 x 543 mm	357,44	1 FF1A72

2101GC-160IP	
2430 GC-200 IP	
2630GC-180IP	
2800-180	
2890-180	
2900-180	
2953-200	
2990-180	
3640-200-C	
3734N-10-150, 3734N-2-150, 3734N-3-150, 3734N-4-150, 3734N-5-150, 3734N-6-150, 3734N-8-150	
479-16	
3625W-35	

FF1A82- 25 piezas



**FF1A82**

	€	
43 x 445 x 543 mm	200,62	1 FF1A82

3734S/6	
479-16	
3625W-35	
MTG-3-16	
KB18-01	
KSBG18-10DISPEN	
2101G-180IP	
2678 G-180	
2470 G-200	
720031	
8224 IP	

FF1F1001-8 piezas



**ergo**



**FF1F1001**

	€	
40 x 362 x 445 mm	115,98	1 FF1F1001

BE-8210, BE-8030, BE-8040, BE-8240, BE-8242, BE-8252, BE-8250L	
BE-8255, BE-8257	

FF1F1002-11 piezas



**ergo**



**FF1F1002**

	€	
40 x 362 x 445 mm	158,58	1 FF1F1002

BE-8020, BE-8040, BE-8242, BE-8252	
BE-8330	
BE-8256, BE-8258	
BE-8610, BE-8620, BE-8623	
BE-8602	



FF1F1003-11 piezas



ergo



**FF1F1003**

38 x 362 x 445 mm € 194,13 1 FF1F1003

BE-8030, BE-8242, BE-8252	⊖	
BE-8155	⊖	
BE-8870	⊖	
BE-8600, BE-8610, BE-8620, BE-8623, BE-8624	⊕	
808050TS	⊖	

FF1F1004-10 piezas



ergo



**FF1F1004**

38 x 362 x 445 mm € 144,07 1 FF1F1004

BE-8904, BE-8907, BE-8908	⊕	
BE-7910, BE-7915, BE-7920, BE-7925, BE-7927, BE-7930, BE-7940	⊕	

FF1F1005-42 piezas



**FF1F1005**

43 x 362 x 445 mm € 227,10 1 FF1F1005

BE-8908, BE-8909, BE-8910, BE-8915, BE-8920, BE-8925, BE-8927, BE-8930	⊕	
K6650-1/4-1P		
808050S	⊖	
808050	⊖	
59S/31-3	⊕	

FF1F1006-8 piezas



ergo



**FF1F1006**

40 x 362 x 445 mm € 133,10 1 FF1F1006

BE-8230S, BE-8040S, BE-8050S, BE-8255S	⊖	
BE-8810S, BE-8820S	⊕	
BE-8610S, BE-8620S	⊕	

FF1F1007-7 piezas



**FF1F1007**

35 x 362 x 445 mm € 100,12 1 FF1F1007

901T-010-100, 901T-015-150, 901T-020-150, 901T-025-150, 901T-027-150, 901T-030-200, 901T-040-200	⊕	
--	---	--

FF1F1008-49 piezas



**FF1F1008**

38 x 362 x 445 mm € 134,31 1 FF1F1008

B219.026	⊖	
B705.1/4.125	⊖	
B146.006.100	⊖	
B145.006.100	⊖	
BE-9770	⊖	
59S/31-1	⊖	

FF1F1009-14 piezas



**FF1F1009**

38 x 362 x 445 mm € 115,98 1 FF1F1009

B219.026	⊖	
B219.025	⊕	
B196.030.100	⊖	
B195.002.025	⊕	
B195.050.025	⊖	



FF1F2001-44 piezas



**FF1F2001**

37 x 362 x 445 mm € 465,27 1 FF1F2001

A6800DM-4, A6800DM-5, A6800DM-5.5, A6800DM-6, A6800DM-7, A6800DM-8, A6800DM-9, A6800DM-10, A6800DM-11, A6800DM-12, A6800DM-13		
6700SM-5, 6700SM-5.5, 6700SM-6, 6700SM-7, 6700SM-8, 6700SM-9, 6700SM-10, 6700SM-11, 6700SM-12, 6700SM-13, 6700SM-14		
6709PH-1, 6709PH-2, 6709PH-3		
6709PZ-1, 6709PZ-2		
6709M-3, 6709M-4, 6709M-5, 6709M-6, 6709M-8		
6709F-4.5, 6709F-5.5, 6709F-8		
BE-9778		
6950SL		
7765		
6954		
6962, 6960-6		
6966		
6972H		
6956		
1998M-12		
6972		

FF1F2002-53 piezas



**FF1F2002**

45 x 362 x 445 mm € 164,84 1 FF1F2002

SL25L	
2058/S26	
6956	
1419-MD	

FF1F2101-36 piezas



**FF1F2101**

37 x 362 x 445 mm € 577,52 1 FF1F2101

7400SM-7, 7400SM-8, 7400SM-9, 7400SM-10, 7400SM-11, 7400SM-12, 7400SM-13, 7400SM-14, 7400SM-15, 7400SM-16, 7400SM-17, 7400SM-18, 7400SM-19, 7400SM-20, 7400SM-21, 7400SM-22		
7409M-4, 7409M-6, 7409M-8, 7409M-10		
A7402DM-10, A7402DM-11, A7402DM-12, A7402DM-13		
A7410DZ-5/16, A7410DZ-7/16, A7410DZ-9/16, A7410DZ-3/8, A7410DZ-5/8		
7750SL		
7762		
7754		
7766		
7764		
8164-1/2		
7756		
7771		

FF1F2102-34 piezas



**FF1F2102**

40 x 362 x 445 mm € 183,14 1 FF1F2102

S330L	
-------	--

FF1F2103-38 piezas

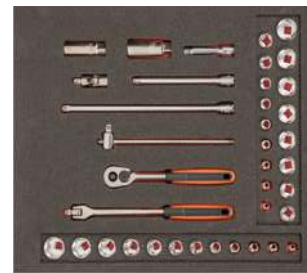

**FF1F2103**

35 x 362 x 445 mm € 141,61 1 FF1F2103

S380	
------	--

FF1F2201-35 piezas



**FF1F2201**

50 x 362 x 445 mm € 426,12 1 FF1F2201

7800SM-10, 7800SM-12, 7800SM-13, 7800SM-17, 7800SM-18, 7800SM-19, 7800SM-20, 7800SM-21, 7800SM-22, 7800SM-24, 7800SM-27, 7800SM-30, 7800SM-32		
7800DM-10, 7800DM-11, 7800DM-12, 7800DM-13, 7800DM-14, 7800DM-15, 7800DM-16, 7800DM-17, 7800DM-18, 7800DM-19		
7809M-5, 7809M-6, 7809M-7, 7809M-8, 7809M-10, 7809M-12		
8150SL		
8160-5, 8160-10		
8166		
8154-11		
8171		



FF1F2202-24 piezas



**FF1F2202**

	€		
50 x 362 x 445 mm	189,25	1	FF1F2202

S240	
S81SL	

FF1F5004-50 piezas



**FF1F5004**

	€		
35 x 362 x 445 mm	177,05	1	FF1F5004

BE5049	
1419-MD	

FF1F5013-39 piezas



**FF1F5013**

	€		
35 x 362 x 445 mm	219,50	1	FF1F5013

BS1000	
--------	--

FF1F2203-27 piezas



**FF1F2203**

	€		
50 x 362 x 445 mm	378,49	1	FF1F2203

K7801M-10, K7801M-12, K7801M-13, K7801M-14, K7801M-15, K7801M-16, K7801M-17, K7801M-18, K7801M-19, K7801M-21, K7801M-22, K7801M-24	
--	--

K7806M-10, K7806M-12, K7806M-13, K7806M-14, K7806M-15, K7806M-16, K7806M-17, K7806M-18, K7806M-19, K7806M-21, K7806M-22, K7806M-24, K7806M-27, K7806M-30, K7806M-32	
---	--

FF1F3001-11 piezas



**FF1F3001**

	€		
40 x 362 x 445 mm	117,03	1	FF1F3001

6M-6-7, 6M-8-9, 6M-10-11, 6M-12-13, 6M-14-15, 6M-16-18, 6M-17-19, 6M-20-22, 6M-21-23, 6M-24-27, 6M-30-32	
--	--

FF1F3002-18 piezas



**FF1F3002**

	€		
41 x 362 x 445 mm	204,24	1	FF1F3002

111M-6, 111M-7, 111M-8, 111M-9, 111M-10, 111M-11, 111M-12, 111M-13, 111M-14, 111M-15, 111M-16, 111M-17, 111M-18, 111M-19, 111M-21, 111M-22, 111M-24, 111M-27	
--	--

FF1F3003-30 piezas



**FF1F3003**

	€		
40 x 362 x 445 mm	272,55	1	FF1F3003

111M-6, 111M-7, 111M-8, 111M-9, 111M-10, 111M-11, 111M-12, 111M-13, 111M-14, 111M-15, 111M-16, 111M-17, 111M-18, 111M-19, 111M-20, 111M-21, 111M-22	
---	--

1320SRM-14-19	
1RMA-19-1/4-SQ	
1RMA-19-1/2-SQ2	
1RMA-13-10-BIT	
BE-9778	

FF1F3004-13 piezas



**FF1F3004**

	€		
42 x 362 x 445 mm	164,84	1	FF1F3004

111Z-3/8, 111Z-11/16, 111Z-1, 111Z-1/2, 111Z-13/16, 111Z-5/16, 111Z-5/8, 111Z-15/16, 111Z-7/16, 111Z-3/4, 111Z-1/4, 111Z-9/16, 111Z-7/8	
---	--

FF1F3005-15 piezas



**FF1F3005**

	€			
39 x 362 x 445 mm	428,56	1	FF1F3005	

1RM-8, 1RM-10, 1RM-12, 1RM-13, 1RM-14, 1RM-15, 1RM-16, 1RM-17, 1RM-18, 1RM-19, 1RM-21, 1RM-22	
1RMA-13-10-BIT	
1RMA-19-1/2-SQ2	

FF1F3008-9 piezas



**FF1F3008**

	€			
38 x 362 x 445 mm	424,91	1	FF1F3008	

4040M-6-7, 4040M-8-9, 4040M-10-11, 4040M-12-13, 4040M-14-15, 4040M- 16-17, 4040M-18-19, 4040M-20-22, 4040M-21-23	
---	--

FF1F3006-7 piezas



**FF1F3006**

	€			
35 x 362 x 445 mm	280,82	1	FF1F3006	

1RM-19, 1RM-21, 1RM-22, 1RM-24, 1RM-27, 1RM-30	
---	--

FF1F3009-8 piezas



**FF1F3009**

	€			
35 x 362 x 445 mm	280,82	1	FF1F3009	

1949M-8-9, 1949M-10-11, 1949M- 12-13, 1949M-14-15, 1949M-17-19, 1949M-19-22, 1949M-24-27, 1949M- 30-32	
---	--

FF1F3007-10 piezas



**FF1F3007**

	€			
47 x 362 x 445 mm	184,30	1	FF1F3007	

2M-6-7, 2M-8-9, 2M-10-11, 2M-12-13, 2M-14-15, 2M-16-18, 2M-17-19, 2M-21- 23, 2M-24-27, 2M-30-32	
---	--

FF1F3010-17 piezas



**FF1F3010**

	€			
35 x 362 x 445 mm	201,47	1	FF1F3010	

1RM/S5



111M/SH12



FF1F3011-13 piezas



**FF1F3011**

	€			
35 x 362 x 445 mm	207,58	1	FF1F3011	

S4RM/3T



111M/SH12



FF1F4001-8 piezas



**FF1F4001**

	€			
35 x 362 x 445 mm	297,92	1	FF1F4001	

2430 G-160 IP



2421 G-180 IP



2101G-160IP



2628 G-200



8224 IP



9029



2951-140, 2951-300





FF1F4002-8 piezas



**FF1F4002**

	€		
35 x 362 x 445 mm	277,16	1	FF1F4002

2928-160		
2951-250		
SC127		
2101G-160IP		
2430 G-160 IP		
2339 DIP		
2628 G-180IP		
8224 IP		

FF1F4003-4 piezas



**FF1F4003**

	€		
35 x 362 x 445 mm	159,68	1	FF1F4003

2101G-160IP		
8224 IP		
2951-180		
2430 G-200 IP		

FF1F4004-8 piezas



**FF1F4004**

	€		
35 x 362 x 445 mm	198,84	1	FF1F4004

2800-140, 2800-180		
2890-140, 2890-180		
2900-140, 2900-180		
2990-140, 2990-180		

FF1F4005-5 piezas



**FF1F4005**

	€		
38 x 362 x 445 mm	224,78	1	FF1F4005

2101S-160		1000 V ESD/1000V	
2430 S-200		1000 V ESD/1000V	
2427 S-200		1000 V ESD/1000V	
8224 IP			
2628 S-180		1000 V ESD/1000V	

FF1F5001-10 piezas



**FF1F5001**

	€		
40 x 362 x 445 mm	221,71	1	FF1F5001

1-100-08-1-2		
1-160-08-1-2		
1-170-08-1-2		
1-210-08-1-2		
1-230-08-1-2		
2430 G-200 IP		
2628G-200IP		
7224		
2101G-160IP		
MTB-3-16		

FF1F5002-5 piezas



**FF1F5002**

	€		
38 x 362 x 445 mm	134,31	1	FF1F5002

2681		
MA401		
MA411		
1178-SCRIBE		
MTG-5-19		

FF1F5003-5 piezas



**FF1F5003**

	€		
35 x 362 x 445 mm	195,36	1	FF1F5003

8224		
2101G-160		
2430 G-160		
8071		
2951-250		

FF1F5005-8 piezas



**FF1F5005**

40 x 362 x 445 mm € 91,57 1 FF1F5005

317	
3906-300-24-5P	
268	
2446	

FF1F5006-4 piezas



**FF1F5006**

50 x 362 x 445 mm € 335,76 1 FF1F5006

CR W 01	
CR B 05	
3418 A	
BMMTRMS1	

FF1F5007-5 piezas



**FF1F5007**

45 x 362 x 445 mm € 207,58 1 FF1F5007

4543-1, 4543-2, 4543-3	
4545-2	
4541-A	

FF1F5008-11 piezas



**FF1F5008**

37 x 362 x 445 mm € 109,88 1 FF1F5008

2633/S4	
2633L/S4	
2489	
2485	
KE18-01	

FF1F5009-5 piezas



**FF1F5009**

60 x 362 x 445 mm € 250,31 1 FF1F5009

BS618, BS623	
4545-2	
4545-N11	
4532-0	

FF1F5010-9 piezas



**FF1F5010**

45 x 362 x 445 mm € 213,67 1 FF1F5010

BBR6135

BBR6131

BBR110

1949M-8-9, 1949M-10-11

7809M-6, 7809M-8, 7809M-10

783

FF1F5011-7 piezas



**FF1F5011**

100 x 362 x 445 mm € 938,22 1 FF1F5011

BP815	
BP821	
BP822	
BP823	

FF1F5012-9 piezas



**FF1F5012**

55 x 362 x 445 mm € 439,56 1 FF1F5012

BWSS12P317, BWSS12P319, BWS-S12P321	
BPC814	
BWTB12P120	
GL008-10	
783	
8157-15	





FF1E1001-7 piezas



ergo



**FF1E1001**

38 x 181 x 445 mm € 96,46 1 FF1E1001

BE-8030, BE-8040, BE-8242, BE-8252



BE-8610, BE-8620, BE-8623



FF1E1002-7 piezas



ergo



**FF1E1002**

39 x 181 x 445 mm € 92,80 1 FF1E1002

BE-8242, BE-8040, BE-8030



BE-8257, BE-8255



BE-8611, BE-8621



FF1E1003-6 piezas



ergo



**FF1E1003**

38 x 181 x 445 mm € 87,91 1 FF1E1003

BE-8240



BE-8150, BE-8255, BE-8256



BE-8810, BE-8820



FF1E1004-8 piezas



ergo



**FF1E1004**

40 x 181 x 445 mm € 97,67 1 FF1E1004

BE-8340, BE-8350



BE-8600, BE-8610



BE-8811, BE-8800, BE-8820L, BE-8821



FF1E1005-7 piezas



ergo



**FF1E1005**

40 x 181 x 445 mm € 89,14 1 FF1E1005

BE-8210, BE-8010



BE-8811, BE-8821, BE-8800



BE-8600



BE-8830



FF1E1006-6 piezas



ergo



**FF1E1006**

40 x 181 x 445 mm € 91,57 1 FF1E1006

BE-8210



BE-8610, BE-8620



BE-8630



BE-8811, BE-8820



FF1E1007-6 piezas



ergo



**FF1E1007**

40 x 181 x 445 mm € 79,36 1 FF1E1007

BE-8910, BE-8915, BE-8920, BE-8925, BE-8930, BE-8940



FF1E1008-6 piezas



ergo



**FF1E1008**

38 x 181 x 445 mm € 94,02 1 FF1E1008

BE-7910, BE-7930, BE-7925, BE-7920, BE-7915, BE-7940



FF1E1009-6 piezas



ergo



**FF1E1009**

38 x 181 x 445 mm € 73,26 1 FF1E1009

BE-8908, BE-8910, BE-8915, BE-8920,  
BE-8925, BE-8930



FF1E1010-6 piezas



ergo



FF1E1010



39 x 181 x 445 mm

€

89,14



1 FF1E1010



BE-8010S, BE-8230S, BE-8050S,  
BE-8255S



BE-8610S, BE-8620S



FF1E1011-6 piezas



ergo



FF1E1011



45 x 181 x 445 mm

€

105,01



1 FF1E1011



BE-8040S, BE-8050S, BE-8255S,  
BE-8065S



BE-8610S, BE-8620S



FF1E2001-37 piezas



FF1E2001



38 x 181 x 445 mm

€

326,40



1 FF1E2001



6700SM-4, 6700SM-5, 6700SM-5.5,  
6700SM-6, 6700SM-7, 6700SM-8,  
6700SM-9, 6700SM-10, 6700SM-11,  
6700SM-12, 6700SM-13, 6700SM-14



6700TORX-E4, 6700TORX-E5,  
6700TORX-E6, 6700TORX-E7,  
6700TORX-E8, 6700TORX-E10

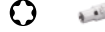

6709M-3, 6709M-4, 6709M-5, 6709M-6,  
6709M-8



6709TORX-T8, 6709TORX-T9,  
6709TORX-T10, 6709TORX-T15,  
6709TORX-T20, 6709TORX-T25,  
6709TORX-T30, 6709TORX-T27,  
6709TORX-T40



6950SL



6954



6956



6960



6966



6960-2



FF1E2002-45 piezas



FF1E2002



38 x 181 x 445 mm

€

344,31



1 FF1E2002

6700SM-4, 6700SM-4.5, 6700SM-5,  
6700SM-5.5, 6700SM-6, 6700SM-7,  
6700SM-8, 6700SM-9, 6700SM-10,  
6700SM-11, 6700SM-12, 6700SM-13,  
6700SM-14



6709PZ-1, 6709PZ-3, 6709PZ-2



6709PH-1, 6709PH-2, 6709PH-3



6709TORX-T10, 6709TORX-T15,  
6709TORX-T20, 6709TORX-T25,  
6709TORX-T30, 6709TORX-T40



6709F-4.5, 6709F-5.5, 6709F-8



6709M-3, 6709M-4, 6709M-5, 6709M-6,  
6709M-8



1998M-3, 1998M-2.5, 1998M-2, 1998M-1.5



6950SL



6962-W, 6954



6966



6956



6960, 6961



7765



6960-2, 6972



6960-4



FF1E2003-27 piezas



FF1E2003



38 x 181 x 445 mm

€

205,12



1 FF1E2003

6700SM-5, 6700SM-5.5, 6700SM-6,  
6700SM-7, 6700SM-8, 6700SM-9,  
6700SM-10, 6700SM-11, 6700SM-12,  
6700SM-13, 6700SM-14



BE-9778



6950SL



6956



6962, 6960-6



6966



7765



6954



1998M-12



6972

FF1E2004-48 piezas



FF1E2004



44 x 181 x 445 mm

€

216,55



1 FF1E2004

A6700DM-8, A6700DM-9, A6700DM-10,  
A6700DM-11, A6700DM-12,  
A6700DM-13, A6700DM-14,  
A6700DM-5, A6700DM-5.5,  
A6700DM-6, A6700DM-7



808050S



6950SL



6966



6972H



6962, 6960-6



7765



59S/31-1

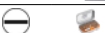

6972



FF1E2005-17 piezas



**FF1E2005**

	€		
35 x 181 x 445 mm	182,73	1	FF1E2005

6700SM-5.5, 6700SM-6, 6700SM-7, 6700SM-8, 6700SM-9, 6700SM-10, 6700SM-11, 6700SM-12, 6700SM-13, 6700SM-14		
6950RN		
6962, 6960, 6960-6		
6966		
6954		
6956		
6972H		
6960-2		

FF1E2006-35 piezas



**FF1E2006**

	€		
39 x 181 x 445 mm	333,25	1	FF1E2006

6700SZ-5/16, 6700SZ-5/32, 6700SZ-11/32, 6700SZ-7/16, 6700SZ-9/32, 6700SZ-3/16, 6700SZ-3/8, 6700SZ-7/32, 6700SZ-1/4, 6700SZ-1/2, 6700SZ-9/16		
6709PZ-1, 6709PZ-2, 6709PZ-3		
6709PH-1, 6709PH-2, 6709PH-3		
6709TORX-T8, 6709TORX-T10, 6709TORX-T15, 6709TORX-T20, 6709TORX-T25, 6709TORX-T30		
6709F-4.5, 6709F-6.5, 6709F-8		
6950RN		
6954, 6963		
6972H		
6960, 6962, 6960-6		
6966		
6956		
7765		
6960-2, 6972		

FF1E2007-24 piezas



**FF1E2007**

	€		
35 x 181 x 445 mm	187,73	1	FF1E2007

6700SZ-9/32, 6700SZ-3/16, 6700SZ-3/8, 6700SZ-1/4, 6700SZ-7/16, 6700SZ-7/32, 6700SZ-1/2, 6700SZ-11/32		
1995Z-5/64, 1995Z-5/32, 1995Z-3/8, 1995Z-3/32, 1995Z-7/32, 1995Z-1/8, 1995Z-5/16, 1995Z-3/16, 1995Z-1/4		
6950RN		
6954		
6972H		
6960, 6962, 6960-6		
6956		
6966		
6960-2		

FF1E2008-26 piezas



**FF1E2008**

	€		
35 x 181 x 445 mm	195,51	1	FF1E2008

6700SM-5.5, 6700SM-6, 6700SM-7, 6700SM-8, 6700SM-9, 6700SM-10, 6700SM-11, 6700SM-12, 6700SM-13, 6700SM-14		
1995M-2, 1995M-3, 1995M-4, 1995M-5, 1995M-6, 1995M-7, 1995M-8, 1995M-9, 1995M-10		
6950RN		
6960, 6962, 6960-6		
6966		
6954		
6956		
6972H		
6960-2		

FF1E2101-24 piezas



**FF1E2101**

	€		
40 x 181 x 445 mm	284,48	1	FF1E2101

7400SM-6, 7400SM-7, 7400SM-8, 7400SM-9, 7400SM-10, 7400SM-11, 7400SM-12, 7400SM-13, 7400SM-14, 7400SM-15, 7400SM-16, 7400SM-17, 7400SM-18, 7400SM-19, 7400SM-20, 7400SM-22		
7750SL		
7760, 7761, 7754		
7762, 7760-3, 7760-5		
7764		
7766		
8164-1/2		
7771		

FF1E2102-25 piezas



**FF1E2102**

	€		
38 x 181 x 445 mm	301,57	1	FF1E2102

7400SM-6, 7400SM-7, 7400SM-8, 7400SM-9, 7400SM-10, 7400SM-11, 7400SM-12, 7400SM-13, 7400SM-14, 7400SM-15, 7400SM-16, 7400SM-17, 7400SM-18, 7400SM-19		
7409M-4, 7409M-5, 7409M-6, 7409M-8, 7409M-10		
7750SL		
7760, 7754		
7762, 7760-3		
7768		
8164-1/2		



FF1E2103-28 piezas



**FF1E2103**

	€		
38 x 181 x 445 mm	363,65	1	FF1E2103

7400SM-7, 7400SM-8, 7400SM-9, 7400SM-10, 7400SM-11, 7400SM-12, 7400SM-13, 7400SM-14, 7400SM-15, 7400SM-16, 7400SM-17, 7400SM-18, 7400SM-19, 7400SM-20, 7400SM-21, 7400SM-22		
7400TORX-E8, 7400TORX-E10, 7400TORX-E12, 7400TORX-E14, 7400TORX-E16, 7400TORX-E18		
7750SL		
7760		
7762, 7760-3		
7768		
7766		
SBS705		

FF1E2105-28 piezas



**FF1E2105**

	€		
35 x 181 x 445 mm	334,55	1	FF1E2105

7400TORX-E8, 7400TORX-E10, 7400TORX-E11, 7400TORX-E12, 7400TORX-E14, 7400TORX-E16, 7400TORX-E18		
7409TORX-T25, 7409TORX-T30, 7409TORX-T40, 7409TORX-T45, 7409TORX-T50		
7409TORX-T25-L, 7409TORX-T30-L, 7409TORX-T40-L, 7409TORX-T45-L, 7409TORX-T50-L		
7409M-4, 7409M-5, 7409M-6, 7409M-8, 7409M-10		
7409F-6.5, 7409F-8, 7409F-10		
7409PH-1, 7409PH-2, 7409PH-3		

FF1E2202-21 piezas



**FF1E2202**

	€		
45 x 181 x 445 mm	240,29	1	FF1E2202

7800SM-8, 7800SM-9, 7800SM-10, 7800SM-11, 7800SM-12, 7800SM-13, 7800SM-14, 7800SM-15, 7800SM-16, 7800SM-17, 7800SM-18, 7800SM-19, 7800SM-20, 7800SM-21, 7800SM-23, 7800SM-24, 7800SM-27		
8150-1/2		
8160-5, 8160-10		
8166		

FF1E2104-20 piezas



**FF1E2104**

	€		
38 x 181 x 445 mm	262,69	1	FF1E2104

7400SM-6, 7400SM-8, 7400SM-9, 7400SM-10, 7400SM-11, 7400SM-12, 7400SM-13, 7400SM-14, 7400SM-15, 7400SM-16, 7400SM-17, 7400SM-18, 7400SM-19, 7400SM-20, 7400SM-22		
7750RN		
7761		
7762, 7760-5		
7766		
7768		

FF1E2201-21 piezas



**FF1E2201**

	€		
44 x 181 x 445 mm	271,99	1	FF1E2201

7800SM-10, 7800SM-11, 7800SM-12, 7800SM-13, 7800SM-14, 7800SM-15, 7800SM-17, 7800SM-18, 7800SM-19, 7800SM-20, 7800SM-21, 7800SM-22, 7800SM-24, 7800SM-27		
7805SM-16, 7805SM-21		
8150SL		
8160-5, 8160-10		
8166		
8171		

FF1E2203-22 piezas



**FF1E2203**

	€		
50 x 181 x 445 mm	252,87	1	FF1E2203

7800SM-8, 7800SM-9, 7800SM-10, 7800SM-11, 7800SM-12, 7800SM-13, 7800SM-14, 7800SM-15, 7800SM-16, 7800SM-17, 7800SM-18, 7800SM-19, 7800SM-22, 7800SM-21, 7800SM-24, 7800SM-27, 7800SM-30, 7800SM-32		
8150RN-1/2		
8160-5, 8160-10		
8166		



FF1E2204-15 piezas



**FF1E2204**

	€		
45 x 181 x 445 mm	199,12	1	FF1E2204

7800DZ-1/2, 7800DZ-3/4, 7800DZ-19/32, 7800DZ-7/8, 7800DZ-7/16, 7800DZ-11/16, 7800DZ-9/16, 7800DZ-13/16, 7800DZ-3/8, 7800DZ-5/8, 7800DZ-15/16		
8150RN-1/2		
8160-5, 8160-10		
8166		

FF1E2205-28 piezas



**FF1E2205**

	€		
50 x 181 x 445 mm	280,82	1	FF1E2205

7800DM-10, 7800DM-11, 7800DM-12, 7800DM-13, 7800DM-14, 7800DM-15, 7800DM-16, 7800DM-17, 7800DM-18, 7800DM-19, 7800DM-20, 7800DM-21, 7800DM-22, 7800DM-23, 7800DM-24, 7800DM-25, 7800DM-26, 7800DM-27, 7800DM-28, 7800DM-30, 7800DM-32		
7809M-6, 7809M-7, 7809M-8, 7809M-9, 7809M-10, 7809M-12, 7809M-14		

FF1E2206-27 piezas



**FF1E2206**

	€		
50 x 181 x 445 mm	275,94	1	FF1E2206

7800SM-10, 7800SM-11, 7800SM-12, 7800SM-13, 7800SM-14, 7800SM-15, 7800SM-16, 7800SM-17, 7800SM-18, 7800SM-19, 7800SM-20, 7800SM-21, 7800SM-22, 7800SM-23, 7800SM-24, 7800SM-25, 7800SM-26, 7800SM-27, 7800SM-28, 7800SM-30, 7800SM-32		
7809XZN-8, 7809XZN-10		
7809PZ-2, 7809PZ-3		
7809F-8, 7809F-10		

FF1E2207-25 piezas



**FF1E2207**

	€		
40 x 181 x 445 mm	290,60	1	FF1E2207

7809TORX-T20, 7809TORX-T25, 7809TORX-T27, 7809TORX-T30, 7809TORX-T40, 7809TORX-T55, 7809TORX-T45, 7809TORX-T50, 7809TORX-T60		
7800TORX-E8, 7800TORX-E10, 7800TORX-E12, 7800TORX-E14, 7800TORX-E16, 7800TORX-E18, 7800TORX-E20, 7800TORX-E24		
BE-9675		

FF1E2208-12 piezas



**FF1E2208**

	€		
35 x 181 x 445 mm	168,77	1	FF1E2208

7809M-6, 7809M-7, 7809M-8, 7809M-9, 7809M-10, 7809M-12, 7809M-14, 7809M-17		
7809M-5-180, 7809M-6-140, 7809M-8-120, 7809M-10-140		

FF1E2209-20 piezas



**FF1E2209**

	€		
35 x 181 x 445 mm	295,48	1	FF1E2209

7809M-5, 7809M-6, 7809M-7, 7809M-8, 7809M-10, 7809M-12, 7809M-14, 7809M-17		
7809TORX-T25, 7809TORX-T27, 7809TORX-T30, 7809TORX-T40, 7809TORX-T45, 7809TORX-T50, 7809TORX-T55, 7809TORX-T60		
7809XZN-6, 7809XZN-8, 7809XZN-10, 7809XZN-12		







FF1E2210-14 piezas



**FF1E2210**



	€		
38 x 181 x 445 mm	231,99	1	FF1E2210









7809M-5, 7809M-6, 7809M-7, 7809M-8, 7809M-10, 7809M-12, 7809M-14, 7809M-17, 7809M-19		
BE-7606, BE-7607		
BWSS12P317, BWSS12P319, BWS-S12P321		

FF1E2211-21 piezas







<b>FF1E2211</b>		€			1 FF1E2211
50 x 181 x 445 mm	323,55				

7993S0050, 7993S0060, 7993S0080, 7993S0100, 7993S0120, 7993S0140, 7993S0170, 7993S0190		
7994S0300, 7994S0400, 7994S0450, 7994S0500, 7994S0550, 7994S0600		
K7801TORX-E10, K7801TORX-E12, K7801TORX-E14, K7801TORX-E16, K7801TORX-E18, K7801TORX-E20, K7801TORX-E24		

FF1E2212-12 piezas







<b>FF1E2212</b>		€			1 FF1E2212
40 x 181 x 445 mm	128,21				

K7801M-10, K7801M-12, K7801M-13, K7801M-14, K7801M-15, K7801M-16, K7801M-17, K7801M-18, K7801M-19, K7801M-21, K7801M-22, K7801M-24		
--	---	---

FF1E2213-15 piezas









<b>FF1E2213</b>		€			1 FF1E2213
45 x 181 x 445 mm	256,41				

K7806M-10, K7806M-12, K7806M-13, K7806M-14, K7806M-15, K7806M-16, K7806M-17, K7806M-18, K7806M-19, K7806M-21, K7806M-22, K7806M-24, K7806M-27, K7806M-30, K7806M-32		
---	---	--

FF1E2501-13 piezas











<b>FF1E2501</b>		€			1 FF1E2501
35 x 181 x 445 mm	226,90				

A7402DM-10, A7402DM-11, A7402DM-12, A7402DM-13, A7402DM-14		
7805SM-12, 7805SM-13, 7805SM-14, 7805SM-15, 7805SM-16, 7805SM-17, 7805SM-18, 7805SM-19		

FF1E2502-7 piezas









<b>FF1E2502</b>		€			1 FF1E2502
45 x 181 x 445 mm	97,67				

K560F-4, K560F-5	
K8167S	
K8160D-1, K8160D-2	
K7764D	
K8964D	

FF1E5005-35 piezas









<b>FF1E5005</b>		€			1 FF1E5005
36 x 181 x 445 mm	164,84				

BWTSP16		
1418S		

FF1E5006-6 piezas



<b>FF1E5006</b>		€			1 FF1E5006
42 x 181 x 445 mm	122,10				

D/S14		
BWSS12P3		
BWTB12P120, BWTB12P110		



FF1E5009-17 piezas



**FF1E5009**

	€		
36 x 181 x 445 mm	85,47	1	FF1E5009

BE6217

FF1E3001-9 piezas



**FF1E3001**

	€		
47 x 181 x 445 mm	115,22	1	FF1E3001

6M-6-7, 6M-8-9, 6M-10-11, 6M-12-13, 6M-14-15, 6M-16-17, 6M-18-19, 6M-21-23, 6M-22-24

FF1E3002-3 piezas



**FF1E3002**

	€		
35 x 181 x 445 mm	89,89	1	FF1E3002

6M-25-28, 6M-27-29, 6M-30-32

FF1E3003-9 piezas



**FF1E3003**

	€		
41 x 181 x 445 mm	122,63	1	FF1E3003

6Z-1/2-9/16, 6Z-15/16-1, 6Z-5/16-11/32, 6Z-5/8-3/4, 6Z-3/8-7/16, 6Z-25/32-13/16, 6Z-19/32-11/16, 6Z-1/4-5/16, 6Z-3/4-7/8

FF1E3004-10 piezas



**FF1E3004**

	€		
39 x 181 x 445 mm	285,70	1	FF1E3004

1RM-10, 1RM-9, 1RM-8, 1RM-14, 1RM-13, 1RM-12, 1RM-11, 1RM-17, 1RM-16, 1RM-15

FF1E3005-40 piezas



**FF1E3005**

	€		
42 x 181 x 445 mm	252,74	1	FF1E3005

59S/31-1

6966

41RM-8, 41RM-10, 41RM-12, 41RM-13, 41RM-14, 41RM-17, 41RM-19

8166

FF1E3006-8 piezas



**FF1E3006**

	€		
35 x 181 x 445 mm	305,24	1	FF1E3006

1320RM-6-7, 1320RM-8-9, 1320RM-10-11, 1320RM-12-13, 1320RM-14-15, 1320RM-16-17, 1320RM-18-19, 1320RM-22-24

FF1E3007-7 piezas



**FF1E3007**

	€		
35 x 181 x 445 mm	95,23	1	FF1E3007

2M-6-7, 2M-8-9, 2M-10-11, 2M-12-13, 2M-14-15, 2M-16-17, 2M-18-19

FF1E3008-9 piezas



**FF1E3008**

	€		
50 x 181 x 445 mm	200,24	1	FF1E3008

27M-8-9, 27M-10-11, 27M-12-13, 27M-14-15, 27M-16-17, 27M-18-19, 27M-20-22, 27M-21-23, 27M-24-27

FF1E4001-4 piezas



ergo®



**FF1E4001**

35 x 181 x 445 mm € 146,26 1 FF1E4001

- 2628 G-180IP
- 8231 IP
- 2430 G-200 IP
- 2101G-160IP

FF1E4002-4 piezas



**FF1E4002**

35 x 181 x 445 mm € 104,76 1 FF1E4002

- 2900-180
- 2890-180
- 2990-180
- 2800-180

FF1E5007-3 piezas



ergo®



**FF1E5007**

38 x 181 x 445 mm € 177,05 1 FF1E5007

- 1410
- 9033
- 8225

FF1E5001-7 piezas



**FF1E5001**

45 x 181 x 445 mm € 207,38 1 FF1E5001

- MTB-5-25
- 8045LVDE
- WR2-MM
- 1544
- 1178-SCRIBE
- 5515T
- 1150D

FF1E5004-35 piezas



**FF1E5004**

36 x 181 x 445 mm € 103,77 1 FF1E5004

- 481-400
- 3734S/6
- 7865

FF1E5002-11 piezas



**FF1E5002**

35 x 181 x 445 mm € 115,98 1 FF1E5002

- 3740-150, 3740-175, 3740-200
- 3734-2, 3734-3, 3734-4, 3734-5, 3734-6, 3734-8
- 481-100
- 1157

FF1E5003-11 piezas



**FF1E5003**

35 x 181 x 445 mm € 109,88 1 FF1E5003

- 481-300
- 3735-5-120
- 3739-300
- 3740-100, 3740-125, 3740-150, 3740-200
- 3733-2, 3733-3, 3733-4, 3733-5

FF1E5008-4 piezas



**FF1E5008**

37 x 181 x 445 mm € 115,98 1 FF1E5008

- 7805ZZ-16, 7805ZZ-21
- BE1P
- BE61110

Incluye 6 piezas



ergo®



**FF1E1012EH**

55 x 185 x 480 mm € 53,11 1 FF1E1012EH

- BE-8030
- BE-8150
- BE-8621, BE-8611
- BE-8811, BE-8821



Incluye 6 piezas



ergo



**FF1E1009EH**

55 x 185 x 480 mm € 53,11 1 FF1E1009EH

BE-8908, BE-8910, BE-8915, BE-8920, BE-8925, BE-8930

Incluye 6 piezas



ergo



**FF1E1013EH**

55 x 185 x 480 mm € 94,41 1 FF1E1013EH

BE-8135TB, BE-8145TB, BE-8150TB, BE-8155TB

BE-8810TB, BE-8820TB

Incluye 46 piezas



**FF1E2009EH**

55 x 185 x 480 mm € 112,12 1 FF1E2009EH

59/S31B-IP

6700SM-4, 6700SM-4.5, 6700SM-5, 6700SM-5.5, 6700SM-6, 6700SM-7, 6700SM-8, 6700SM-9, 6700SM-10, 6700SM-11, 6700SM-12, 6700SM-13

6962-W

6972H

6950SL

Incluye 11 piezas



**FF1E2010EH**

55 x 185 x 480 mm € 59,01 1 FF1E2010EH

S0810L

1419-MD

Incluye 18 piezas



**FF1E2106EH**

55 x 185 x 480 mm € 106,21 1 FF1E2106EH

7400SM-10, 7400SM-11, 7400SM-12, 7400SM-13, 7400SM-14, 7400SM-15, 7400SM-16, 7400SM-17, 7400SM-18, 7400SM-19, 7400SM-20, 7400SM-22

7760, 7761

7766

SBS750

7402GPR-16, 7402GPR-21

7760-3, 7760-5

Incluye 21 piezas



**FF1E2214EH**

55 x 185 x 480 mm € 236,02 1 FF1E2214EH

7800SM-10, 7800SM-11, 7800SM-12, 7800SM-13, 7800SM-14, 7800SM-15, 7800SM-16, 7800SM-17, 7800SM-18, 7800SM-19, 7800SM-20, 7800SM-21, 7800SM-22, 7800SM-23, 7800SM-24, 7800SM-27, 7800SM-30, 7800SM-32

8150SL

8174A

8166

Incluye 14 piezas



**FF1E2107EH**

55 x 185 x 480 mm € 76,71 1 FF1E2107EH

S1214L

Incluye 12 piezas



**FF1E2215EH**

55 x 185 x 480 mm € 94,41 1 FF1E2215EH

S1612L

Incluye 49 piezas



**FF1E2503EH**

55 x 185 x 480 mm € 147,52 1 FF1E2503EH

BE5049

Incluye 11 piezas



**FF1E3009EH**

55 x 185 x 480 mm € 88,51 1 FF1E3009EH

111M-8, 111M-10, 111M-11, 111M-12, 111M-13, 111M-14, 111M-15, 111M-16, 111M-17, 111M-18, 111M-19

FF1E3010EH, 1/3, 5 piezas



**FF1E3010EH**

55 x 185 x 480 mm € 94,41 1 FF1E3010EH

1RM-8, 1RM-10, 1RM-13, 1RM-17, 1RM-19



Incluye 4 piezas



### FF1E3011EH

	€		
55 x 185 x 480 mm	112,12	1	FF1E3011EH

8070 IP, 8071 IP, 8072 IP	
1419-MD	

Incluye 3 piezas



### FF1E4003EH

	€		
55 x 185 x 480 mm	100,31	1	FF1E4003EH

8224 IP	
2101G-160IP	
2430 G-160 IP	

Incluye 4 piezas



### FF1E4004EH

	€		
55 x 185 x 480 mm	112,12	1	FF1E4004EH

2681	
MA401	
MA411	
1178-SCRIBE	

Incluye 23 piezas



### FF1E5010EH

	€		
55 x 185 x 480 mm	106,21	1	FF1E5010EH

481-400	
3734-2, 3734-3, 3734-4, 3734-5, 3734-6, 3734-8	
3735-5-120	
7865	

Incluye 4 piezas



### FF1E4005EH

	€		
55 x 185 x 480 mm	123,92	1	FF1E4005EH

2800-150, 2800-180	
2900-150, 2900-180	

Incluye 11 piezas



### FF1E5011EH

	€		
55 x 185 x 480 mm	100,31	1	FF1E5011EH

2633/S4	
2633L/S4	
2489	
2485	
KE18-01	

Incluye 36 piezas



### FF1E5013EH

	€		
55 x 185 x 480 mm	94,41	1	FF1E5013EH

BE-9770	
2058/S26	
1419-MD	

Incluye 25 piezas



### FF1E2011EH

	€		
55 x 185 x 480 mm	70,81	1	FF1E2011EH

SL25	
------	--

Incluye 24 piezas



### FF1E2216EH

	€		
55 x 185 x 480 mm	147,52	1	FF1E2216EH

SBS81	
S240NB-NR	

Incluye 33 piezas



### FF1E2504EH

	€		
55 x 185 x 480 mm	94,41	1	FF1E2504EH

S330	
------	--





Incluye 34 piezas



### FF1E2505EH

	€		
55 x 185 x 480 mm	94,41	1	FF1E2505EH

S330AF

Incluye 8 piezas



### FF1E5014EH

	€		
55 x 185 x 480 mm	106,21	1	FF1E5014EH

9031P

8224

208

3906-300-24-5P

Foam 1/3 vacío con colgador



### FF1E5016EH

	€		
35 x 181 x 445 mm	29,50	1	FF1E5016EH

Incluye 4 piezas



### FF1E5015EH

	€		
55 x 185 x 480 mm	59,01	1	FF1E5015EH

1-100-08-2-2

1-210-08-2-2

4-138-08-1-2

4-272-05-3-2

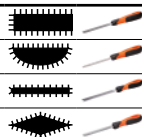

Montaje de anillos y pinzas sólidas 1477K



### 1477K-AC11

	€		
30 x 39 x 68 mm	18,24	1	1477K-AC11

Tubo multifunción largo para 1477K



### 1477K-AC28

	€		
455 x 25 x 25 mm	18,24	1	1477K-AC28

Tubo multifunción corto para 1477K



### 1477K-AC29

	€		
130 x 25 x 25 mm	14,58	1	1477K-AC29

Llavero de repuesto para llaves de carro



### KEYRING

	kg	€		
10 x 30 x 70 mm	0.20 kg	10,08	50	KEYRING

Papel con pegatinas



### 1477K-AC23

	€		
1 x 210 x 300 mm	7,33	1	1477K-AC23

Set 7 alfombrillas protectoras para proteger los cajones



### 1470KAC1

	€		
0.5 x 445 x 543 mm	18,41	1	1470KAC01

## MALETAS RÍGIDAS

Maleta rígida 4750RCWD4 con 162 herramientas



### 4750RCWD4FF1

453 x 340 x 575 mm 2.249,20 1 4750RCWD4FF1

<b>4750RCWD4</b>	
6700SM-10, 6700SM-9, 6700SM-12, 6700SM-11, 6700SM-6, 6700SM-8, 6700SM-7, 6700SM-13	
A6800DM-13, A6800DM-12, A6800DM-9, A6800DM-8, A6800DM-11, A6800DM-10, A6800DM-5.5, A6800DM-7, A6800DM-6	
6709M-3, 6709M-8, 6709M-6, 6709M-5, 6709M-4	
6709PH-1, 6709PH-3, 6709PH-2	
6709TORX-T30, 6709TORX-T27, 6709TORX-T40, 6709TORX-T15, 6709TORX-T10, 6709TORX-T25, 6709TORX-T20, 6709TORX-T9, 6709TORX-T8	
6950SL	
6954, 7764, 2058-BR, BFLA01	
6956	
6958	
6960, 6962, 6962L	
6966	
6972H	
7800SM-25, 7800SM-24, 7800SM-27, 7800SM-26, 7800SM-21, 7800SM-23, 7800SM-22, 7800SM-17, 7800SM-16, 7800SM-19, 7800SM-18, 7800SM-13, 7800SM-12, 7800SM-15, 7800SM-14, 7800SM-9, 7800SM-8, 7800SM-11, 7800SM-10, 7800SM-28, 7800SM-32, 7800SM-30	

7809TORX-T45, 7809TORX-T25, 7809TORX-T50, 7809TORX-T30, 7809TORX-T27, 7809TORX-T40	
8150RN-1/2	
111M-30, 111M-32, 111M-27, 111M-29, 111M-24, 111M-19, 111M-18, 111M-21, 111M-15, 111M-14, 111M-17, 111M-16, 111M-11, 111M-10, 111M-13, 111M-12, 111M-7, 111M-6, 111M-9, 111M-8	
9070C	
BE-9770	
1544	
MTB-3-16	
2101G-160IP	
2427 G-200 IP	
2430 G-200 IP	
2628 G-160IP	
8224 IP	
1150-1/2H/P	
5515T-52	
2820EF2	
481-300	
3625W-35	
3734-3, 3734-5, 3734-8	
3735-4-120	
1177-SCRIBE	
8160-3, 8160-5, 8160-10	
8166	
8157-15	
8154-11	

Maleta rígida extra fuerte roja con 79 herramientas aisladas



### 4750RCHDW02RF1V

290 x 480 x 630 mm 3.127,39 1 4750RCHDW02RF1V

<b>4750RCHDW02RED</b>	
8150-1/2V	1000 V IEC00900
<b>BMMTRMS1</b>	
28MV-10, 28MV-15, 28MV-16, 28MV-21, 28MV-22, 28MV-12, 28MV-13	1000 V IEC00900
2101S-160, 2101S-180	1000 V IEC00900
2101S-200	1000 V IEC00900
2223 S-150	1000 V IEC00900
2820VDE	1000 V IEC00900
BE-8040S, BE-8050S, BE-8010S, BE-8065S	
BE-8703S, BE-8704S, BE-8725S, BE-8705S, BE-8706S, BE-8708S	
BE-8910S, BE-8915S, BE-8920S, BE-8925S, BE-8930S	
SC127V	1000 V IEC00900
1999MV-5, 1999MV-6, 1999MV-7, 1999MV-8, 1999MV-9, 1999MV-10, 1999MV-12	1000 V IEC00900
2430V-160, 2430V-200	1000 V IEC00900
2678V-180, 2678V-160, 2678V-200	1000 V IEC00900
3416 A	
806-1-1	
BE-8600S, BE-8610S, BE-8620S, BE-8630S, BE-8640S	
527V-160	1000 V IEC00900
2427V-200	1000 V IEC00900
2MV-10, 2MV-11, 2MV-12, 2MV-13, 2MV-14, 2MV-15, 2MV-16, 2MV-17, 2MV-18, 2MV-19	1000 V IEC00900
<b>WR1-MM</b>	
7800DMV-8, 7800DMV-10, 7800DMV-11, 7800DMV-12, 7800DMV-13, 7800DMV-14, 7800DMV-15, 7800DMV-16, 7800DMV-17, 7800DMV-18, 7800DMV-19, 7800DMV-20, 7800DMV-21, 7800DMV-22	1000 V IEC00900
2820VPC	1000 V IEC00900
8162-1/2V	1000 V IEC00900
7224S	1000 V IEC00900



Maleta rígida 4750RCHDW02 HD con ruedas y composición para MRO



### 4750RCHDW02FF1

275 x 460 x 600 mm € 2.566,81 1 4750RCHDW02FF1

4750RCHDW02	
6700SM-12, 6700SM-13, 6700SM-10, 6700SM-11, 6700SM-8, 6700SM-9, 6700SM-6, 6700SM-7, 6700SM-5.5	
A6800DM-13, A6800DM-11, A6800DM-12, A6800DM-9, A6800DM-10, A6800DM-7, A6800DM-8, A6800DM-5.5, A6800DM-6	
6709M-3, 6709M-4, 6709M-8, 6709M-5, 6709M-6	
6709PH-1, 6709PH-2, 6709PH-3	
6709TORX-T8, 6709TORX-T30, 6709TORX-T40, 6709TORX-T25, 6709TORX-T27, 6709TORX-T15, 6709TORX-T20, 6709TORX-T9, 6709TORX-T10	
6950SL	
6954, 7764, 2058-BR, BFLA01	
6956	
6958	
6960, 6962, 6962L	
6966	
6972H	
7800SM-13, 7800SM-14, 7800SM-11, 7800SM-12, 7800SM-9, 7800SM-10, 7800SM-8, 7800SM-32, 7800SM-30, 7800SM-27, 7800SM-28, 7800SM-25, 7800SM-26, 7800SM-23, 7800SM-24, 7800SM-21, 7800SM-22, 7800SM-19, 7800SM-17, 7800SM-18, 7800SM-15, 7800SM-16	
7805SM-22, 7805SM-23, 7805SM-21, 7805SM-18, 7805SM-19, 7805SM-16, 7805SM-17, 7805SM-14, 7805SM-15, 7805SM-12, 7805SM-13, 7805SM-10, 7805SM-32, 7805SM-30, 7805SM-26, 7805SM-27, 7805SM-24, 7805SM-29, 7805SM-28, 7805SM-25, 7805SM-20	
7809TORX-T30, 7809TORX-T40, 7809TORX-T25, 7809TORX-T27, 7809TORX-T50, 7809TORX-T45	
8150RN-1/2	
111M-23, 111M-24, 111M-21, 111M-22, 111M-19, 111M-17, 111M-18, 111M-15, 111M-16, 111M-13, 111M-14, 111M-11, 111M-12, 111M-9, 111M-10, 111M-7, 111M-8, 111M-6, 111M-32, 111M-29, 111M-30, 111M-27, 111M-28, 111M-26, 111M-25	
1RM-18, 1RM-19, 1RM-16, 1RM-17, 1RM-14, 1RM-15, 1RM-12, 1RM-13, 1RM-10, 1RM-11, 1RM-8, 1RM-9, 1RM-6, 1RM-7	
9070C	
BE-9770	

BE-8571	
2509	
1544	
2101G-160IP	
2427 G-200 IP	
2430 G-200 IP	
2628 G-160IP	
8224 IP	
1150-1/2H/P	
5515T-52	
2820EF2	
481-300	
3625W-35	
3734-3, 3734-5, 3734-8	
3735-4-120	
1177-SCRIBE	
2535F1	
MTB-3-16	
8160-3, 8160-5, 8160-10	
8166	
8154-11	
8157-15	

Maleta rígida 4750RCHDW02 con 167 herramientas para industria eólica



### 4750RCHDW02FF2

480 x 290 x 630 mm € 2.891,35 1 4750RCHDW02FF2

4750RCHDW02	
6700SM-12, 6700SM-13, 6700SM-10, 6700SM-11, 6700SM-8, 6700SM-9, 6700SM-6, 6700SM-7, 6700SM-5.5	
6954, 2058-BR, BFLA01	
6956	
6958	
6960, 6961, 6962, 6962L	
6966	
6972H	
6950SL	
7800SM-13, 7800SM-14, 7800SM-11, 7800SM-12, 7800SM-10, 7800SM-32, 7800SM-30, 7800SM-27, 7800SM-24, 7800SM-21, 7800SM-19, 7800SM-17, 7800SM-18, 7800SM-15, 7800SM-16, 7800SM-22	

7809M-7, 7809M-6, 7809M-17, 7809M-19, 7809M-5, 7809M-14, 7809M-12, 7809M-10, 7809M-8	
7809TORX-T60, 7809TORX-T40, 7809TORX-T55, 7809TORX-T50, 7809TORX-T45	
59S/31-1	
8150SL	
111M-24, 111M-21, 111M-19, 111M-17, 111M-18, 111M-15, 111M-16, 111M-13, 111M-14, 111M-11, 111M-12, 111M-9, 111M-10, 111M-7, 111M-8, 111M-6, 111M-32, 111M-29, 111M-30, 111M-27	
BE-9770	
1177-SCRIBE	
6M-6-7, 6M-8-9, 6M-10-11, 6M-12-13, 6M-14-15, 6M-16-17, 6M-18-19, 6M-20-22, 6M-24-27, 6M-30-32	
MTB-3-16-E	
9070, 9072	
2535L	
BE-8020L, BE-8030	
BE-8155	
BE-8260	
BE-8610, BE-8620	
BE-8630	
BE-8810, BE-8820	
BE-8830	
1544	
2047-0-8-4	
TAH2047PR-1-2	
2509	
808050P	
808050S	
BE-8220S, BE-8040S, BE-8050S	
BE-8610S, BE-8620S	
2535F2	
1150-1/2H/P	
2101G-160IP	
2427 G-200 IP	
2430 G-200 IP	
2628 G-160IP	
2820EF2	
5515T-52	
8224 IP	
3625W-35	
3734-3, 3734-5, 3734-8	
3735-4-120	
481-300	
3680	
3875-RL1	
3875-WL1	
4750-3PB-2	
3750	
8157-15	
8154-11	
8160-5, 8160-10	
8171	
8166	

Maleta con set para mantenimiento de aerogeneradores



**4750RCHDW02FF4**



480 x 290 x 630 mm € 4.078,11 1 4750RCHDW02FF4

TAH9070, TAH9072		
TAH3625W-35		
TAH481-300		
TAHBE-9777B		
TAH2820EF2		
TAH1150-1/2H/P		
TAH1177-SCRIBE		
TAH1544		
TAH2509		
TAH2535F2		
MTS-5-25		
TAHPINRELEASER		
TAH2427G-200		
TAH2430G-200		
TAH2628G-160		
TAH8224		
TAH2484-30		
TAH3734BM-3, TAH3734BM-8, TAH-3734BM-5		
TAH3755BM-4		
TAHSCB140G		
TAHBE-8030, TAHBE-8020L		
TAHBE-8040S, TAHBE-8050S, TAHBE-8220S		
TAHBE-8155		
TAHBE-8260		
TAHBE-8620S, TAHBE-8610S		
TAHBE-8620, TAHBE-8610		
TAHBE-8630		
TAHBE-8810, TAHBE-8820		
TAHBE-8830		
TAH08-5.5, TAH08-9, TAH08-7, TAH08-8, TAH08-13, TAH08-6, TAH08-11, TAH08-10, TAH08-12		
TAH6961, TAH6962, TAH6960, TAH6962L		
TAH6956-1		
TAH6950		
TAH6966		
TAH6958B-1		

TAH16B-27, TAH16B-30, TAH16B-24, TAH16B-22, TAH16B-32, TAH16B-19, TAH16B-21, TAH16B-17, TAH16B-18, TAH16B-11, TAH16B-15, TAH16B-16, TAH16B-13, TAH16B-10, TAH16B-14, TAH16B-12		
TAH16-H8, TAH16-H6, TAH16-H7, TAH16-H5, TAH16-H17, TAH16-H19, TAH16-H12, TAH16-H14, TAH16-H10		
TAH16-T40, TAH16-T45, TAH16-T50, TAH16-T55, TAH16-T60		
TAH8166		
TAH8150-1/2		
TAH8160, TAH8162		
TAH8158B-1		
TAH111M-32, TAH111M-27, TAH111M-24, TAH111M-21, TAH111M-22, TAH111M-19, TAH111M-9, TAH111M-7, TAH111M-8, TAH111M-18, TAH111M-6, TAH111M-16, TAH111M-17, TAH111M-14, TAH111M-15, TAH111M-12, TAH111M-13, TAH111M-10, TAH111M-11, TAH111M-30		
TAH2101G-160		
TAH2047PR-1-2		
TAH2047-0.8-4		
4750RCHDW02		

Set para aerogeneradores heavy duty



**4750RCHDW02FF15**



480 x 290 x 630 mm € 3.771,53 1 4750RCHDW02FF15

TAH1-100-06-2-4		
TAH1-210-06-2-2		
TAH1-230-06-2-2		
TAH3625PU-50		
TAH489-1100		
TAHBE64520		
TAHPINRELEASER		
TAHSCB140G		
TAH24B-50, TAH24B-46, TAH24B-41, TAH24B-38, TAH24B-36, TAH24B-32, TAH24B-30, TAH24B-27		
TAH8950N/A		
TAH8961		
TAH8953		
TAH7452-2		
TAH7435-100		
TAH111M-50, TAH111M-46, TAH111M-41, TAH111M-36, TAH111M-34		

TAH7444SG-M-46, TAH7444SG-M-41, TAH7444SG-M-36, TAH7444SG-M-55, TAH7444SG-M-50		
4750RCHDW02		
TAH73R-300		

Maleta rígida 4750RCHDW01 con 240 herramientas



**4750RCHDW01FF1**

250 x 345 x 545 mm € 4.274,90 1 4750RCHDW01FF1

4750RCHDW01		
FF2B01		
FF2B02		
FF2B03		
FF2B04		
FF2B05		
FF2B06		

Maleta rígida 4750RCHDW01 con 159 herramientas



**4750RCHDW01FF2**

250 x 345 x 545 mm € 3.089,35 1 4750RCHDW01FF2

4750RCHDW01		
FF2B07		
FF2B08		
FF2B09		
FF2B10		
FF2B11		





Maleta rígida 4750RCHDW01 con 194 herramientas



### 4750RCHDW01FF3



250 x 345 x 545 mm 2.751,16 1 4750RCHDW01FF3

4750RCHDW01	
FF2B12	
FF2B13	
FF2B14	
FF2B15	
FF2B16	

Set para mantenimiento de gruas de gas y petróleo en el agua



### 4750RCHDW01FF4

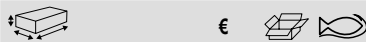

250 x 345 x 545 mm 1.933,21 1 4750RCHDW01FF4

TAH8075	
TAH479-32	
TAHBE-9777B	
TAHBE-9787	
TAH2820EF2	
TAHBFRL11	
TAH466-250	

TAHPINRELEASER	
TAH380-10	
TAH2101G-160	
TAH2628G-180	
TAH2855	
TAH8224	
TAHSCB140G	
TAHBE-8258	
TAHBE-8241, TAHBE-8252	
TAHBE-8620L, TAHBE-8620	
4750RCHDW01	
4750-HDLB-TAH	
3875-LY9	
3875-LY5	
3875-RL2	
3875-MHP4	
3875-MHP6	
3875-HB60	
3875-LY60	
3875-LY70	

Set para formación de gas y petróleo en el agua



### 4750RCHDW01FF9

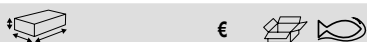

250 x 345 x 545 mm 2.919,89 1 4750RCHDW01FF9

TAH8073	
TAH84-PODGER	
TAH3640-250-C	
TAH1-143-12-1-2	
TAH479-32	
TAH325	
TAHBE-9777B	
TAH2820EF2	
TAHBFRL11	
TAHPINRELEASER	
TAH380-14	
TAH2101G-140	
TAH2628G-180	
TAH2855	

TAH2958-250	
TAH2484-30	
TAH3734BM-8	
TAHSCB140G	
TAHBE-8257	
TAHBE-8602	
TAH16B-19	
TAH16B-11/16	
TAH16-H8	
TAH8150-1/2	
TAH8158B-1	
TAH1949M-14-17	
4750RCHDW01	
4750-HDLB-TAH	
3875-LY9	
3875-LY5	
3875-RL2	
3875-MHP4	
3875-MHP6	
MTS-5-25	
4750-MTHO-TAH	
3875-HB60	
TAH2487	
TAH466-250	
3875-LY60	
3875-LY70	
TAH73R-300	

Maleta rígida 4750RCHD01 + FF2A07 + FF2A08 + FF2A09 + FF2A10



### 4750RCHD01FF1

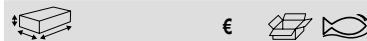

215 x 410 x 475 mm 2.832,35 1 4750RCHD01FF1

4750RCHD01	
FF2A07	
FF2A08	
FF2A10	
FF2A09	



Caja de herramientas Aluminio, 145 piezas



**4750ALC01FF1**

160 x 320 x 450 mm € 832,81 1 4750ALC01FF1

111M-14, 111M-15, 111M-16, 111M-17, 111M-18, 111M-19, 111M-8, 111M-9, 111M-10, 111M-11, 111M-12, 111M-13	
BE-9678	
8072 C IP	
224 D	
2171G-160	
2339-220IP	
2678 G-180	
2470 G-160	
SCB140	
B191.030.075, B191.040.125	
B190.055.125, B190.065.150	
B192.001.100, B192.002.125	
806-1-1	
482F-30	
MTB-5-25	
208	
KB18-01	
808050TS	
59S/0.6-4.5-3P, 59S/1.0-5.5-3P, 59S/1.2-6.5-3P	
59S/PH1-3P, 59S/PH2-3P, 59S/PH3-3P, 59S/PH0-3P	
59S/PH2G-3P	
59S/PZ2-3P, 59S/PZ3-3P, 59S/PZ0-3P, 59S/PZ1-3P	
66IM/T20C-2P, 66IM/T15C-2P, 66IM/T10C-2P, 66IM/T40C-2P, 66IM/T30C-2P, 66IM/T27C-2P, 66IM/T25C-2P	
59S/H1.5-3P, 59S/H3-3P, 59S/H2.5-3P, 59S/H4-3P, 59S/H5-3P, 59S/H2-3P, 59S/H6-3P, 59S/H8-3P	
KM6750-11, KM6750-6, KM6750-7, KM6750-8	
KM6750-10, KM6750-13, K6650-1/4-1P, SB6963	
KM653-1P	
KSBG18-10DISPEN	
700-1.5-50, 700-1.2-50, 700-1-50, 700-1.8-50	
701-00-50, 701-0-50	
3906-250-24-5P, 3906-250-32-5P	
3735N-4-120	
3734N-2-150, 3734N-4-150, 3734N-6-150	
SBS60-9, SBS60-10, SBS60-11, SBS60-12, SBS60-13, SBS60-4, SBS60-4.5, SBS60-5, SBS60-5.5, SBS60-6, SBS60-7, SBS60-8	
SBS61	
SBS64	

6960-3	
8160-10, 8160-5	
8158-10	
7800SM-20, 7800SM-21, 7800SM-22, 7800SM-23, 7800SM-24, 7800SM-27, 7800SM-12, 7800SM-13, 7800SM-14, 7800SM-15, 7800SM-16, 7800SM-17, 7800SM-18, 7800SM-19, 7800SM-10, 7800SM-11, 7800SM-30, 7800SM-32	
SBS81	
8166	
7772H	

Maleta rígida con ruedas con 32 herramientas



**984010320**

255 x 390 x 465 mm € 838,43 1 984010320

Dotación: TS001

4750RCW01	
2101D-160IP	
224 D	
2630D-180	
2430 D-160 IP	
6M/8C	
8071 C IP	
483-20	
541D-180	
2951-180	
B191.030.075, B191.040.100	
B190.100.200, B190.065.150	
B192.001.100, B192.002.125	
SC127	
2820EF2	
BE-9777	
MTB-3-16	

Maleta rígida con dotación 32 herramientas



**983100320**

210 x 415 x 460 mm € 579,07 1 983100320

4750RC02	
2101D-160IP	
224 D	
2430 D-160 IP	
8071 C IP	
483-20	
541D-180	
2951-180	
B191.030.075, B191.040.100	
B190.100.200, B190.065.150	
B192.001.100, B192.002.125	
SC127	
2820EF2	
BE-9777	
MTB-3-16	
2630DC-180IP	
6M/8C	

Maleta rígida con dotación de 32 herramientas



**983000320**

162 x 380 x 435 mm € 541,76 1 983000320

Set 32 herramientas: TS001

4750RC01	
2101D-160IP	
224 D	
2630D-180	
2430 D-160 IP	
8071 C IP	
483-20	
541D-180	
2951-180	
6M/8C	
B191.030.075, B191.040.100	
B190.100.200, B190.065.125	
B192.001.100, B192.002.125	
SC127	
2820EF2	
BE-9777	
MTB-3-16	



Maleta rígida extra fuerte con cuatro cajones



**4750RCWD4**

	€		
453 x 340 x 575 mm	800,80	1	4750RCWD4

Maleta rígida copolimero extra fuerte



**4750RCHD01**

	€		
215 x 415 x 465 mm	290,00	1	4750RCHD01*

Maleta rígida



**4750RC01**

	€		
165 x 399 x 450 mm	223,38	1	4750RC01

Maleta con ruedas extra fuerte



**4750RCHDW02**

	€		
290 x 480 x 630 mm	526,07	1	4750RCHDW02
290 x 480 x 630 mm	526,07	1	4750RCHDW02RED

Copolimero inyectado en estructura de resina en polipropileno

Maleta rígida extra fuerte con separadores



**4750RCHD011**

	€		
215 x 415 x 465 mm	472,10	1	4750RCHD011

Juego de ruedas giratorias (x4) 50x18mm



**4750RCWD-AC1**

	€		
100 x 50 x 200 mm	82,62	1	4750RCWD-AC1

Para 4750RCWD4

Maleta rígida con ruedas Extra Fuerte



**4750RCHDW01**

	€		
240 x 350 x 545 mm	335,19	1	4750RCHDW01
240 x 350 x 545 mm	335,19	1	4750RCHDW01RED

estructura de resina en polipropileno

Maleta rígida extra fuerte



**4750RCHD00**

	€		
205 x 345 x 400 mm	228,79	1	4750RCHD00*

Divisor pivotante para colocar bajo la tapa con huecos tipo bolsa



**4750RCWD-AC2**

	€		
30 x 277 x 507 mm	76,26	1	4750RCWD-AC2

Divisor pivotante para colocar bajo la tapa con tiras elásticas



**4750RCWD-AC3**

	€		
5 x 277 x 507 mm	76,26	1	4750RCWD-AC3

Panel fijo para colocar bajo la tapa con tiras elásticas



**4750RCWD-AC4**

	€		
4 x 286 x 490 mm	57,21	1	4750RCWD-AC4

Panel desmontable tapa acolchada



**4750RCHD01AC1**

	€		
35 x 305 x 425 mm	53,95	1	4750RCHD01AC1

Bolsa acolchada extraíble para maleta 4750RCHD01



**4750RCHD01AC2**

	€		
135 x 360 x 450 mm	128,15	1	4750RCHD01AC2

Panel desmontable tapa acolchada



**4750RCHDW01AC1**

	€		
50 x 204 x 500 mm	53,95	1	4750RCHDW01AC1

Bolsa acolchado extraíble



**4750RCHDW01AC2**

	€		
120 x 280 x 525 mm	128,15	1	4750RCHDW01AC2

Candado TSA homologado para maleta 4750RCHD



**4750RCHD-AC1**

	€		
20 x 40 x 70 mm	39,11	1	4750RCHD-AC1

Foam para maleta 4750RCHD01, 64 piezas



**FF2A07**

	€		
45 x 330 x 430 mm	1.034,27	1	FF2A07

A6700DZ-1/2, A6700DZ-1/4, A6700DZ-11/32, A6700DZ-3/16, A6700DZ-3/8, A6700DZ-5/16, A6700DZ-7/16, A6700DZ-7/32, A6700DZ-9/16, A6700DZ-9/32		
A6710DZ-3/8, A6710DZ-5/16, A6710DZ-7/16, A6710DZ-1/4		
A6800DZ-1/2, A6800DZ-1/4, A6800DZ-11/32, A6800DZ-3/16, A6800DZ-3/8, A6800DZ-5/16, A6800DZ-7/16, A6800DZ-7/32, A6800DZ-9/16, A6800DZ-9/32		
A7400DZ-1/2, A7400DZ-11/16, A7400DZ-13/16, A7400DZ-19/32, A7400DZ-3/4, A7400DZ-3/8, A7400DZ-5/8, A7400DZ-7/16, A7400DZ-7/8, A7400DZ-9/16		
A7402DZ-1/2, A7402DZ-11/16, A7402DZ-13/16, A7402DZ-19/32, A7402DZ-3/4, A7402DZ-3/8, A7402DZ-5/8, A7402DZ-7/16, A7402DZ-7/8, A7402DZ-9/16		
2058-BR, 6954, 7764		
6950SL		
6956		
6960, 6962, 6962L		
6966		
6972H		
7407H, 7408H		
7750SL		
7752		
7760, 7761		
7762		
7765		
7766		
8164-1/2		

\* Hasta agotar existencias





Foam para maleta 4750RCHD01, 24 piezas



**FF2A08**

	€		
45 x 335 x 435 mm	461,07	1	FF2A08

1-100-04-2-2	
1-230-04-2-2	
111Z-1, 111Z-1/2, 111Z-1/4, 111Z-11/16, 111Z-3/4, 111Z-3/8, 111Z-5/16, 111Z-5/8, 111Z-7/16, 111Z-9/16, 111Z-7/8	
1177-SCRIBE	
1320RZ-1/2-9/16, 1320RZ-1/4-5/16, 1320RZ-3/8-7/16, 1320RZ-5/16-11/32	
1931Z-1/4, 1931Z-3/16, 1931Z-7/32	
1950MZ-3/8	
208	
9031 C	

Foam para maleta 4750RCHD01, 56 piezas



**FF2A09**

	€		
45 x 335 x 440 mm	532,55	1	FF2A09

BE-8040, BE-8210	
BE-8260	
BE-8600, BE-8610, BE-8620	
BE-9780	
MTB-3-16-E	
2047-1-5-5	
2047PR-1-2	
59/S28-4	
2509	
2535F2	
5515T-52	
808050	
1179-FLX-2, BFLA01	
BE-8150	

Foam para maleta 4750RCHD01, 15 piezas



**FF2A10**

	€		
49 x 330 x 435 mm	568,37	1	FF2A10

2101GC-160IP	
2427 GC-200IP	
2628 GC-160IP	
2632	
2650	
2855	
2979 D-180	
3625N-32	
3734-2, 3734-3, 3734-4, 3734-5	
3735-4-120	
481-300	
8224CIP	

Foam para maleta 4750RCHDW01, 61 piezas



**FF2B01**

	€		
40 x 270 x 505 mm	1.001,14	1	FF2B01

A6700DZ-1/2, A6700DZ-1/4, A6700DZ-11/32, A6700DZ-3/16, A6700DZ-3/8, A6700DZ-5/16, A6700DZ-7/16, A6700DZ-7/32, A6700DZ-9/16, A6700DZ-9/32	
A6800DZ-1/2, A6800DZ-1/4, A6800DZ-11/32, A6800DZ-3/16, A6800DZ-3/8, A6800DZ-5/16, A6800DZ-7/16, A6800DZ-7/32, A6800DZ-9/16, A6800DZ-9/32	
A7400DZ-1/2, A7400DZ-1/4, A7400DZ-11/16, A7400DZ-17/32, A7400DZ-19/32, A7400DZ-3/4, A7400DZ-3/8, A7400DZ-5/16, A7400DZ-5/8, A7400DZ-7/16, A7400DZ-9/16	

A7402DZ-1/2, A7402DZ-1/4, A7402DZ-11/16, A7402DZ-19/32, A7402DZ-3/4, A7402DZ-3/8, A7402DZ-5/16, A7402DZ-5/8, A7402DZ-7/16, A7402DZ-9/16

6950SL	
6954, 7764	
6956	
6958	
6960, 6961, 6962L	
6966	
6972H	
7407H	
7750SL	
7752	
7760, 7761	
7762	
7765	
7766	
8164-1/2	
U-S6106KA	

Foam para maleta 4750RCHDW01, 69 piezas



**FF2B02**

	€		
39 x 270 x 505 mm	751,87	1	FF2B02

A6700DM-5.5, A6700DM-6, A6700DM-11, A6700DM-12, A6700DM-13, A6700DM-14, A6700DM-7, A6700DM-8, A6700DM-9, A6700DM-10	
A6800DM-6, A6800DM-7, A6800DM-8, A6800DM-9, A6800DM-4, A6800DM-5, A6800DM-5.5, A6800DM-14, A6800DM-10, A6800DM-11, A6800DM-12, A6800DM-13	
A7400DM-10, A7400DM-14, A7400DM-15, A7400DM-16, A7400DM-11, A7400DM-12, A7400DM-17, A7400DM-18, A7400DM-19, A7400DM-13	
A7402DM-19, A7402DM-15, A7402DM-16, A7402DM-17, A7402DM-18, A7402DM-11, A7402DM-12, A7402DM-13, A7402DM-14, A7402DM-10	
BE-9770	
111M-24, 111M-6, 111M-7, 111M-12, 111M-13, 111M-14, 111M-15, 111M-8, 111M-9, 111M-10, 111M-11, 111M-22, 111M-16, 111M-17, 111M-18, 111M-19	
4020L-M-5, 4020L-M-5.5	



Foam para maleta 4750RCHDW01, 44 piezas



**FF2B03**

	€		
35 x 270 x 505 mm	820,32	1	FF2B03

A6710DM-7	
A6710DZ-1/2, A6710DZ-1/4, A6710DZ-11/32, A6710DZ-3/16, A6710DZ-3/8, A6710DZ-5/16, A6710DZ-7/16, A6710DZ-7/32, A6710DZ-9/16, A6710DZ-9/32	
BE-9780	
111Z-1, 111Z-1/2, 111Z-1/4, 111Z-11/16, 111Z-3/4, 111Z-3/8, 111Z-5/16, 111Z-5/8, 111Z-7/16, 111Z-7/8, 111Z-9/16, 111Z-13/16	
1320RZ-1/2-9/16, 1320RZ-1/4-5/16, 1320RZ-3/8-7/16, 1320RZ-5/16-11/32	
1931Z-1/4, 1931Z-3/16, 1931Z-7/32	
1950MZ-3/8	
2058-BR	

Foam para maleta 4750RCHDW01, 45 piezas



**FF2B04**

	€		
42 x 270 x 505 mm	464,22	1	FF2B04

BE-8020L, BE-8040	
BE-8080-10	
BE-8150, BE-8255	
BE-8610, BE-8620	
1544	
2509	
59/S28-4	
2535F2	
5516	
700-1.5-50, 700-1-50	
701-0-50, 701-00-50	
808050	
9070C	

Foam para maleta 4750RCHDW01, 15 piezas



**FF2B05**

	€		
35 x 270 x 510 mm	765,76	1	FF2B05

1150-1/2H/P	
MTB-3-16-M-E	
2101GC-125IP, 2101GC-160IP	
2427 GC-200IP	
2628 GC-160IP	
2650	
2820EF2	
2855	
4130	
4830	
5515T-52	
8224CIP	
BFLA01, 1179-FLX-2	

Foam para maleta 4750RCHDW01, 6 piezas



**FF2B06**

	€		
35 x 122 x 355 mm	110,23	1	FF2B06

3625N-32	
3734-5, 3734-8, 3734-3	
3735-5-120	
481-300	

Foam para maleta 4750RCHDW01, 62 piezas



**FF2B07**

	€		
35 x 270 x 505 mm	987,38	1	FF2B07

A6700DZ-1/2, A6700DZ-1/4, A6700DZ-11/32, A6700DZ-3/16, A6700DZ-3/8, A6700DZ-5/16, A6700DZ-7/16, A6700DZ-7/32, A6700DZ-9/16, A6700DZ-9/32	
A6710DZ-3/8, A6710DZ-5/16, A6710DZ-7/16	
A6800DZ-1/2, A6800DZ-1/4, A6800DZ-11/32, A6800DZ-3/16, A6800DZ-3/8, A6800DZ-5/16, A6800DZ-7/16, A6800DZ-7/32, A6800DZ-9/16, A6800DZ-9/32	
A7400DZ-1/2, A7400DZ-11/16, A7400DZ-13/16, A7400DZ-19/32, A7400DZ-3/4, A7400DZ-3/8, A7400DZ-5/8, A7400DZ-7/16, A7400DZ-7/8, A7400DZ-9/16	
A7402DZ-1/2, A7402DZ-11/16, A7402DZ-13/16, A7402DZ-19/32, A7402DZ-3/4, A7402DZ-3/8, A7402DZ-5/8, A7402DZ-7/16, A7402DZ-7/8, A7402DZ-9/16	
6950SL	
6954, 7764	
6956	
6960, 6962, 6962L	
6966	
6972H	
7407H, 7408H	
7750SL	
7752	
7760, 7761	
7762	
7765	
7766	
8164-1/2	

Foam para maleta 4750RCHDW01, 25 piezas



**FF2B08**

	€		
44 x 270 x 505 mm	461,29	1	FF2B08

1-100-04-2-2	
1-230-04-2-2	
111Z-1, 111Z-1/2, 111Z-1/4, 111Z-11/16, 111Z-3/4, 111Z-3/8, 111Z-5/16, 111Z-5/8, 111Z-7/16, 111Z-7/8, 111Z-9/16	
1177-SCRIBE	
1320RZ-1/2-9/16, 1320RZ-1/4-5/16, 1320RZ-3/8-7/16, 1320RZ-5/16-11/32	
1931Z-1/4, 1931Z-3/16, 1931Z-7/32	
1950MZ-3/8	
2058-BR	
208	
9031 C	



Foam para maleta 4750RCHDW01, 56 piezas



**FF2B09**

	€		
47 x 270 x 505 mm	548,96	1	FF2B09

BE-8040, BE-8210		
BE-8150		
BE-8260		
BE-8600, BE-8610, BE-8620		
BE-9780		
MTB-3-16-E		
2047-1-5.5		
2047PR-1-2		
2509		
2535F2		
5515T-52		
59/S28-4		
BFLA01, 1179-FLX-2		
808050		

Foam para maleta 4750RCHDW01, 9 piezas



**FF2B10**

	€		
37 x 270 x 505 mm	511,18	1	FF2B10

2101GC-160IP	
2427 GC-200IP	
2430 GC-200 IP	
2628 GC-160IP	
2650	
2744	
2855	
2979 D-180	
8224CIP	

Foam para maleta 4750RCHDW01, 7 piezas



**FF2B11**

	€		
39 x 122 x 355 mm	127,53	1	FF2B11

2632	
3625N-32	
3734-2, 3734-3, 3734-4, 3734-5	
481-300	

Foam para maleta 4750RCHDW01, 92 piezas



**FF2B12**

	€		
44 x 270 x 505 mm	1.114,44	1	FF2B12

A6800DM-6, A6800DM-7, A6800DM-8, A6800DM-9, A6800DM-5.5, A6800DM-10, A6800DM-11, A6800DM-12, A6800DM-13	
A7402DM-19, A7402DM-15, A7402DM-16, A7402DM-17, A7402DM-18, A7402DM-11, A7402DM-12, A7402DM-13, A7402DM-14, A7402DM-10	
6700SM-5.5, 6700SM-6, 6700SM-11, 6700SM-12, 6700SM-13, 6700SM-7, 6700SM-8, 6700SM-9, 6700SM-10	
6709M-3, 6709M-4, 6709M-5, 6709M-6, 6709M-8	
6709PH-1, 6709PH-2, 6709PH-3	
6709TORX-T20, 6709TORX-T25, 6709TORX-T27, 6709TORX-T30, 6709TORX-T8, 6709TORX-T9, 6709TORX-T10, 6709TORX-T15, 6709TORX-T40	
6954, 7764	
6956	
6958	
6960, 6961, 6962, 6962L	
6966	
6972H	
7400SM-6, 7400SM-11, 7400SM-12, 7400SM-13, 7400SM-14, 7400SM-7, 7400SM-8, 7400SM-9, 7400SM-10, 7400SM-19, 7400SM-22, 7400SM-15, 7400SM-16, 7400SM-17, 7400SM-18	

7407H	
7409M-8, 7409M-10, 7409M-4, 7409M-5, 7409M-6, 7409M-7, 7409M-3	
7409TORX-T25, 7409TORX-T27, 7409TORX-T30, 7409TORX-T40, 7409TORX-T45, 7409TORX-T50	
7750SL	
7761, 7760	
7762	
7765	
7766	
8164-1/2	
6950SL	

Foam para maleta 4750RCHDW01, 39 piezas



**FF2B13**

	€		
50 x 270 x 505 mm	504,50	1	FF2B13

BE-9770	
111M-12, 111M-13, 111M-14, 111M-15, 111M-8, 111M-9, 111M-10, 111M-11, 111M-6, 111M-7, 111M-21, 111M-22, 111M-16, 111M-17, 111M-18, 111M-19	
6M-6-7, 6M-8-9, 6M-10-11, 6M-12-13, 6M-14-15, 6M-16-17, 6M-18-19, 6M-20-22	
9070C	
1177-SCRIBE	
2535F2	
BFLA01	
7758	
7754	

Foam para maleta 4750RCHDW01, 48 piezas



**FF2B14**

	€		
35 x 270 x 505 mm	352,71	1	FF2B14

BE-8020L, BE-8030		
BE-8155		
BE-8260		
BE-8350		
BE-8601, BE-8602		
BE-8610, BE-8620		
BE-8630		
1544		
2047-0.8-4		
2047PR-1-2		
2058-BR		
2509		
808050P		
808050S		
59S/31-1		

Foam para maleta 4750RCHDW01, 9 piezas



### FF2B15

	€		
35 x 270 x 505 mm	353,65	1	FF2B15

1150-1/2H/P	
2101GC-160IP	
2427 GC-200IP	
2430 GC-200 IP	
2628 GC-160IP	
2820EF2	
5515T-52	
8224CIP	
MTB-3-16-M-E	

Foam para maleta 4750RCHDW01, 6 piezas



### FF2B16

	€		
34 x 122 x 355 mm	87,79	1	FF2B16

3625W-35	
3734-3, 3734-5, 3734-8	
3735-4-120	
481-300	

Incluye 51 piezas



### FF2C01

	€		
45 x 390 x 530 mm	401,26	1	FF2C01

SBS81	
SL25	
BMMTRMS1	
S240	

## ARMARIOS Y PANELES

Armario con persiana 1495CS18 + 981001100, ganchos incluidos



### 1495CS18TS1

	€		
900 x 170 x 1800 mm	2.294,73	1	1495CS18TS1

1495CS18	
981001100	
1495CS-AC1	
1495TP-AC10	

Armario con persiana 1495CS15 + 981001100, ganchos incluidos



### 1495CS15TS1

	€		
900 x 170 x 1500 mm	2.174,53	1	1495CS15TS1

1495CS15	
981001100	
1495CS-AC1	
1495TP-AC10	

Armario con puertas 1495CD60 + 981001100, ganchos incluidos



### 1495CD60TS1

	€		
900 x 250 x 602 mm	2.020,68	1	1495CD60TS1

1495CD60	
981001100	
1495CD-AC1	
1495TP-AC10	





Composición 109 herramientas



**981001100**

X	kg	€		
109	27 kg	1.585,76	1	981001100

1546	
2521GC-160	
2630GC-180IP, 2630GC-200IP	
6M-12-13, 6M-14-15, 6M-10-11, 6M-6-7, 6M-8-9, 6M-20-22, 6M-21-23, 6M-24-27, 6M-25-28	
8150RN-1/2	
8154-1/2, 2421GC-160, 8160-1/2, 8162-1/2, 8166-1/2	
9048-400	
9-469-00-0-0	
1998M/10T	
3733-4	
3734-4	
814-100	
815-2-25, 815-1-100, 815-2-125	
9710-8-150, 9710-6.5-125	
2101GC-200HL	
2800-180	
SC127	
1-100-08-2-2, 1-100-10-2-2	
1150-1/2H/P	
2101D-140IP	
2535F1	
3906-300-24-2P	
2951-250	
2M-6-7, 2M-8-9, 2M-10-11, 2M-12-13, 2M-14-15, 2M-16-17, 2M-18-19, 2M-20-22, 2M-21-23, 2M-24-27	
3645-150-C	
4544-10	
813-3-75, 813-4-100, 813-5.5-125	
1-230-08-1-2	
2430 GC-160 IP	
3735-4-120	
2900-180	
3625W-35	
479-16	
869102500	
1-170-08-2-2	
1-210-08-2-2	
8072 C, 8071 C	
225-PLUS	
2427 GC-200IP	

3640-150-C

7800DM-18, 7800DM-17, 7800DM-16, 7800DM-11, 7800DM-10, 7800DM-15, 7800DM-14, 7800DM-13, 7800DM-12, 7800DM-19, 7800DM-23, 7800DM-22, 7800DM-21, 7800DM-20, 7800DM-24, 7800DM-26, 7800DM-28, 7800DM-30, 7800DM-32, 7800DM-27	
--	--

813VDE-3-100	
6224	

Panel de herramientas con persiana y ganchos



**1495CS18HK**

	€		
900 x 170 x 1800 mm	863,25	1	1495CS18HK
900 x 170 x 1800 mm	863,25	1	1495CS18BLHK

Armario con persiana



**1495CS1**

	€		
900 x 170 x 1500 mm	709,62	1	1495CS15
900 x 170 x 1800 mm	792,29	1	1495CS18
900 x 170 x 1500 mm	709,62	1	1495CS15BL
900 x 170 x 1800 mm	792,29	1	1495CS18BL

BK: negro / BL: Azul / RED: Rojo

Armario mural 2 puertas



**1495CD60**

	€		
900 x 250 x 602 mm	523,60	1	1495CD60

BK: negro / BL: Azul / RED: Rojo

Armario 2 puertas sobre ruedas



**1495CD60W**

	€		
1605 x 450 x 625 mm	1.088,53	1	1495CD60W

BK: negro / BL: Azul / RED: Rojo

Panel de herramientas con composición auto 62 piezas



**1495TP-AUTO-M1**

	€		
900 x 25 x 500 mm	1.209,65	1	1495TP-AUTO-M1

1495TP09	
BP910	
BP909TH	
BE-9678	
BE-9675	
29M-30	



2997-250	
1995LM-9, 1995LM-8, 1995LM-6	
3750	
1177-SCRIBE	
K7801M-9, K7801M-10, K7801M-11, K7801M-12, K7801M-13, K7801M-14, K7801M-15, K7801M-16, K7801M-17, K7801M-18, K7801M-19, K7801M-21, K7801M-22, K7801M-23, K7801M-24, K7801M-30, K7801M-32	
K7806M-15, K7806M-21, K7806M-24, K7806M-27	
K8901M-32, K8901M-34, K8901M-36	
K8964D	
K8167S	
K8160D-3	
2800-150	
2900-150	
3734S/6	
BE-8258TB	
1495TP-ACHL40x 9, 1495TP-ACHL65x 9, 1495TP-ACHL20x 33	

Panel de herramientas con composición auto 34 piezas



Panel de herramientas con composición auto 23 piezas



Panel de herramientas con composición auto 53 piezas



### 1495TP-AUTO-M3

	€		
900 x 25 x 500 mm	1.180,14	1	1495TP-AUTO-M3

1495TP09	
BE1GP5-T	
6968	
BE1SP1F	
BE6OF108	
BE6307414F	
BE6OFW	
BE1FFWF	
BE63064514F1	
BE6810Z, BE6810	
BE6FCP	
52	
1546	
2421GC-160, 7764, 6962-W, 6954, 8166-1/2	
5515M	
BE1P	
7455-60	
BE1FLD2, BE1FLD1, BE1FLD3	
BE65F65120	
8164-1/2	
BE6302712F	
BE6701VAG	
BE62110	
BE1310P427	
7406ZZ-21, 7406ZZ-16	
BE1SP14L	
BE1GP5	
1495TP-AC3	
1495TP-ACHL20x 38, 1495TP-ACHL40, 1495TP-ACHL65	

### 1495TP-AUTO-M2

	€		
900 x 25 x 500 mm	2.124,26	1	1495TP-AUTO-M2

1495TP09	
BE301	
K7801TORX-E10, K7801TORX-E12, K7801TORX-E14, K7801TORX-E16, K7801TORX-E18, K7801TORX-E20	
K8160D-2	
BE301CM	
BWHEPSSH8	
BE51038, BE510310, BE510312	
BP822	
BP825	
1495TP-ACHL40x 25, 1495TP-ACHL65x 4, 1495TP-ACHL20x 29	
1495TP-AC4	

### 1495TP-AUTO-M4

	€		
900 x 25 x 500 mm	1.498,78	1	1495TP-AUTO-M4

1495TP09	
BS618	
4545-N1, 4545-N11	
4545-1, 4545-2	
MTB-3-16	
361-14	
8900SM-41	
BS52	
8169-1/2, 8165-1/2	
747-22, 747-21, 747-19, 747-17, 747-15, 747-14, 747-13, 747-12	
BS40VAG	
BS56	
BS100PSA1	
BS45BMW	
1495TP-ACHL40x 10, 1495TP-ACHL65x 5, 1495TP-ACHL20x 20	



Panel de herramientas con composición auto 32 piezas



### 1495TP-AUTO-M5

900 x 25 x 500 mm € 920,51 1 1495TP-AUTO-M5

1495TP09	
319	
484-1000	
SB3654BM-20	
3625S-44	
B192.004.200	
BE-8258TB	
2484/S4	
B194.030.150, B194.025.125, B194.020.100, B194.010.075	
600.005.012	
BBS165	
K7801TORX-E10, K7801TORX-E12, K7801TORX-E14, K7801TORX-E16, K7801TORX-E18, K7801TORX-E20, K7801TORX-E24	
BBR203P920, BBR203P925, BBR203P930, BBR203P940, BBR203P945, BBR203P950, BBR203P955, BBR203P960	
1495TP-ACHL40x 13, 1495TP-ACHL20x 38	
8226	

Panel de herramientas con composición auto 42 piezas

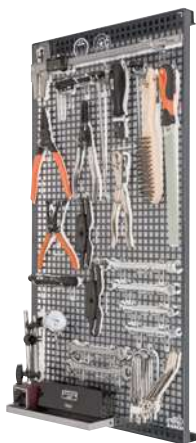

### 1495TP-AUTO-M6

900 x 25 x 500 mm € 1.239,15 1 1495TP-AUTO-M6

1495TP09	
FM10	
782-U	
BBR405	
BBR400	
BBR210P3	
BBR6131	
BBR204	
BBR150I	
BBR501011, BBR50121314	
2900-215	
7823	
BBR100	
1154	
6M-16-17, 6M-14-15	
1949M-17-19, 1949M-12-13, 1949M-10-11, 1949M-8-9	
1495TP-ACHL40x 2, 1495TP-ACHL20x 29	
1495TP-AC3	

Panel de herramientas

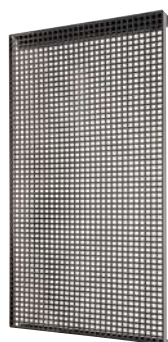

### 1495TP09

900 x 25 x 500 mm € 120,28 1 1495TP09

Panel de herramientas

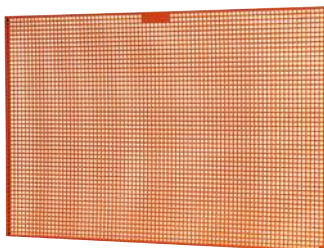

### 1495TP

500 x 23 x 600 mm € 117,12 1 1495TP06  
 800 x 25 x 1200 mm € 172,24 1 1495TP12  
 800 x 23 x 1500 mm € 206,68 1 1495TP15  
 800 x 23 x 1800 mm € 241,13 1 1495TP18

Rail para panel de herramientas 1495TP09



### 1495TP09-RAIL

40 x 57 x 440 mm € 38,24 1 1495TP09-RAIL

Adaptadores para el panel y banco de trabajo



### 1495TP-AC1

9.5 kg € 89,56 1 1495TP-AC1

Juego de ganchos - 24 piezas

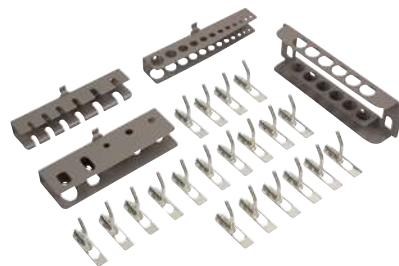

### 1495CD-AC1

1.22 kg € 82,68 1 1495CD-AC1

Juego de ganchos - 35 piezas

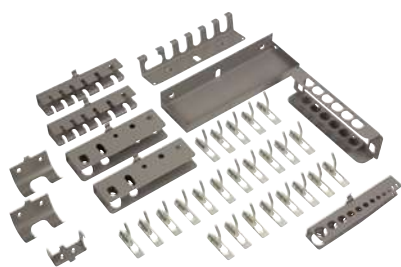

**1495CS-AC1**

<b>kg</b>	€		
2.11 kg	124,01	1	1495CS-AC1

Soporte para martillo 70x48x46mm



**1495TP-AC12**

<b>kg</b>	€		
0.07 kg	8,55	1	1495TP-AC12

Juego de soporte y bandeja para vasos 260x80x40mm



**1495TP-AC3**

<b>kg</b>	€		
0.45 kg	16,87	1	1495TP-AC3

Soporte para 12 llaves fijas - combinadas .. 165x42x333mm



**1495TP-AC10**

<b>kg</b>	€		
0.43 kg	15,85	1	1495TP-AC10

Soporte para mango en T 56x37x27mm



**1495TP-AC13**

<b>kg</b>	€		
0.04 kg	9,99	1	1495TP-AC13

Bandeja de plástico 100x90x50mm



**1495TP-AC4**

<b>kg</b>	€		
0.125 kg	15,50	1	1495TP-AC4

Soporte para 6 destornilladores 166x30x26mm

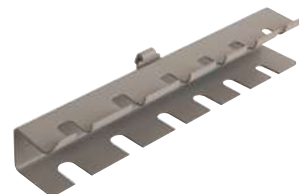

**1495TP-AC5**

<b>kg</b>	€		
0.14 kg	7,57	1	1495TP-AC5

Soporte para 6 botadores 213x30x65mm

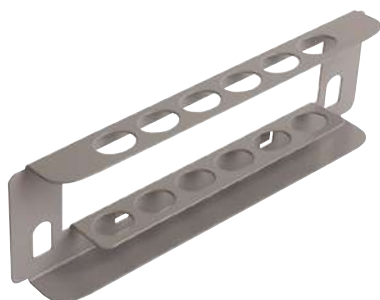

**1495TP-AC11**

<b>kg</b>	€		
0.16 kg	6,62	1	1495TP-AC11

Bandeja 238x125x40mm



**1495TP-AC2**

<b>kg</b>	€		
0.44 kg	12,40	1	1495TP-AC2

Soporte para 5 alicates 175x55x26mm



**1495TP-AC6**

<b>kg</b>	€		
0.17 kg	7,86	1	1495TP-AC6



Soporte para Tenaza Grip 46x75x36mm



**1495TP-AC7**

kg	€		
0.79 kg	6,21	1	1495TP-AC7

Soporte para 12 llaves hexagonales 180x33x25mm

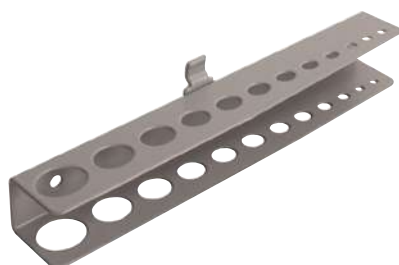

**1495TP-AC8**

kg	€		
0.12 kg	7,16	1	1495TP-AC8

Soporte para 12 llaves de tubo 74x50x398mm



**1495TP-AC9**

kg	€		
0.43 kg	17,22	1	1495TP-AC9

Ganchos para armarios y paneles (x5)



**1495TP-ACH**

kg	€		
0.116 kg	9,36	1	1495TP-ACHL20
0.125 kg	9,36	1	1495TP-ACHL40
0.144 kg	10,20	1	1495TP-ACHL65
0.17 kg	10,89	1	1495TP-ACHL90
0.102 kg	9,65	1	1495TP-ACHU20
0.125 kg	9,99	1	1495TP-ACHU40
0.146 kg	10,89	1	1495TP-ACHU65
0.162 kg	11,15	1	1495TP-ACHU90

Banco de trabajo de 180cm con encimera de acero y cajonera lateral



**1495KCWB18TS**

	€		
1030 x 750 x 1800 mm	1.639,69	1	1495K6CWB18TS
1030 x 750 x 1800 mm	1.736,14	1	1495K7CWB18TS
1030 x 750 x 1800 mm	1.784,37	1	1495K8CWB18TS

Banco de trabajo de 150cm con encimera de acero y cajonera lateral



**1495KCWB15TS**

	€		
1030 x 750 x 1500 mm	1.570,79	1	1495K6CWB15TS
1030 x 750 x 1500 mm	1.667,25	1	1495K7CWB15TS
1030 x 750 x 1500 mm	1.715,48	1	1495K8CWB15TS

Kit de encimera de acero



**1495KW-TS**

	€		
1030 x 750 x 1500 mm	957,63	1	1495KWB15TS
1030 x 750 x 1800 mm	806,06	1	1495KWB18TS

Banco de trabajo de 180 cm con encimera de madera y cajonera lateral



**1495KCWB18TW**

	€		
1030 x 750 x 1800 mm	1.956,61	1	1495K6CWB18TW
1030 x 750 x 1800 mm	2.053,06	1	1495K7CWB18TW
1030 x 750 x 1800 mm	2.101,28	1	1495K8CWB18TW

Banco de trabajo de 150 cm con encimera de madera y cajonera lateral



**1495KCWB15TW**

	€		
1030 x 750 x 1500 mm	1.818,82	1	1495K6CWB15TW
1030 x 750 x 1500 mm	1.915,26	1	1495K7CWB15TW
1030 x 750 x 1500 mm	1.715,48	1	1495K8CWB15TW



Kit de Encimera de madera



**1495KWB-TW**

	€		
1030 x 750 x 1500 mm	1.164,31	1	1495KWB15TW
1030 x 750 x 1800 mm	1.371,00	1	1495KWB18TW

Banco de trabajo con encimera de acero



**1495WB-TS**

	€		
1030 x 750 x 1500 mm	723,40	1	1495WB15TS
1030 x 750 x 1800 mm	806,06	1	1495WB18TS
1030 x 750 x 1500 mm	667,60	1	1495WB15TSBL
1030 x 750 x 1800 mm	806,06	1	1495WB18TSBL

BK: negro

Cajoneras para bancos de trabajo



**1495WB-AC**

	€		
105 x 500 x 500 mm	130,90	1	1495WB-AC1

Banco de trabajo 1.800m con bandeja inferior



**1495WB18TSBT**

	€		
1030 x 750 x 1800 mm	969,97	1	1495WB18TSBT

Banco de trabajo con encimera de madera



**1495WB-TW**

	€		
1030 x 750 x 1500 mm	1.164,32	1	1495WB15TW
1030 x 750 x 1800 mm	1.329,66	1	1495WB18TW

Banco de trabajo 1.500m con bandeja inferior



**1495WB15TSBT**

	€		
1030 x 750 x 1500 mm	682,95	1	1495WB15TSBT

Bandeja inferior para bancos de trabajo



**1495WB1-AC**

	€		
30 x 504 x 1500 mm	144,67	1	1495WB15-AC1
30 x 504 x 1800 mm	172,24	1	1495WB18-AC1

Banco de trabajo plegable con encimera galvanizada



**1495FWBTS**

	€		
840 x 510 x 1200 mm	419,11	1	1495FWB120TS

**CAJAS DE HERRAMIENTAS METÁLICAS**

Caja metálica 1483KHD3RB con 129 herramientas



**1483KHD3RB-FF1**

	€		
335 x 260 x 565 mm	2.848,40	1	1483KHD3RB-FF1

1483KHD3RB			
FF3A01			
FF3A02			
FF3A03			
FF3A04			



Caja metálica 1483KHD3RB con 144 herramientas



**1483KHD3RB-FF2**

335 x 260 x 565 mm 2.776,62 1 1483KHD3RB-FF2

1483KHD3RB	
FF3A05	
FF3A06	
FF3A07	
FF3A08	
2509	
2535F2	
3625N-32	
481-400	
7762	

Caja metálica 1483KHD3RB con 188 herramientas



**1483KHD3RB-FF3**

335 x 260 x 565 mm 2.718,48 1 1483KHD3RB-FF3

1483KHD3RB	
FF3A09	
FF3A10	
FF3A11	
FF3A12	

Caja metálica 1483KHD3RB con 142 herramientas



**1483KHD3RB-FF4**

335 x 260 x 565 mm 2.260,23 1 1483KHD3RB-FF4

1483KHD3RB	
FF3A10	
FF3A11	
FF3A12	
FF3A13	

Caja metálica 1483KHD3RB con 142 herramientas



**1483KHD3RB-FF5**

335 x 260 x 565 mm 2.716,82 1 1483KHD3RB-FF5

1483KHD3RB	
FF3A14	
FF3A15	
FF3A16	
FF3A17	

Caja metálica con 3 cajones y 124 htas.



**1483KHD3RB-FF7**

335 x 260 x 565 mm 2.065,25 1 1483KHD3RB-FF7\*

1483KHD3RB	
481-400	
2535F1	
7762	
6950SL	
6960, 6962	
6956	
7752	
6966	
6972H	
A6700DZ-3/16, A6700DZ-7/32, A6700DZ-1/4, A6700DZ-9/32, A6700DZ-5/16, A6700DZ-11/32, A6700DZ-3/8, A6700DZ-7/16, A6700DZ-1/2, A6700DZ-9/16	
A6710DZ-1/4, A6710DZ-5/16, A6710DZ-11/32, A6710DZ-3/8, A6710DZ-7/16	
A6800DZ-3/16, A6800DZ-7/32, A6800DZ-1/4, A6800DZ-9/32, A6800DZ-5/16, A6800DZ-11/32, A6800DZ-3/8, A6800DZ-7/16, A6800DZ-1/2, A6800DZ-9/16	
A6800DM-4	
BE-9780	
59/S28-4	
59S/TS-1/4	
9070 P	
808050	
2058-BR	
KE18-01	
1150-1/2H/P	
2047-1-5.5	
2047PR-1-2	
BE-8030	
BE-8150	
BE-8260	
BE-8350	
BE-8602	

BE-8610, BE-8620		
5515T-52		
1177-SCRIBE		
SR300-E		
704Z-3/32		
MTB-3-16-M-E		
2101GC-160IP		
2427 GC-200IP		
2855		
8224CIP		
2628 GC-160IP		
2632		
3734-3, 3734-5, 3734-8		
1300Z-1/4-5/16		
1320RZ-1/4-5/16, 1320RZ-3/8-7/16		
1952Z-15/16, 1952Z-1, 1952Z-1/4, 1952Z-5/16, 1952Z-11/32, 1952Z-3/8, 1952Z-7/16, 1952Z-1/2, 1952Z-9/16, 1952Z-5/8, 1952Z-11/16, 1952Z-3/4, 1952Z-13/16, 1952Z-7/8		
6Z-19/32-11/16		
3625N-32		

Caja metálica 3 cajones con tapa reforzada



**1483KHD3RB**

		€		
305 x 233 x 523 mm	13050 g	560,88	1	1483KHD3RB

Foam para caja de herramientas 1483K y 1483KHD, 93 piezas



Caja metálica 4 cajones con tapa reforzada



**1483KHD4RB**

		€		
390 x 260 x 593 mm	15200 g	661,03	1	1483KHD4RB

Caja metálica 3 cajones



**1483K3RB**

		€		
334 x 260 x 523 mm	10200 g	413,99	1	1483K3RB

Caja metálica 2 cajones



**1483K2RB**

		€		
277 x 257 x 525 mm	8200 g	340,53	1	1483K2RB

Caja metálica con 3 cajones y bandeja superior



**1484THD3RB**

		€		
300 x 220 x 520 mm	12.40 kg	498,42	1	1484THD3RB

Carretilla para cajas metálicas 1483K



**1483CART**

		€		
200 x 270 x 655 mm	6.02 kg	216,09	1	1483CART

**FF3A01**

	€		
64 x 245 x 505 mm	997,22	1	FF3A01

A6700DZ-1/2, A6700DZ-1/4, A6700DZ-11/32, A6700DZ-3/8, A6700DZ-5/16, A6700DZ-7/16, A6700DZ-7/32, A6700DZ-9/32		
A6710DZ-3/8, A6710DZ-5/16, A6710DZ-7/16		
A6800DZ-1/4, A6800DZ-5/16, A6800DZ-7/32, A6800DZ-9/32		
A7400DM-10, A7400DM-13		
A7400DZ-1/2, A7400DZ-11/16, A7400DZ-3/4, A7400DZ-5/8, A7400DZ-9/16		
A7402DZ-1/2, A7402DZ-3/8, A7402DZ-7/16, A7402DZ-9/16		
1320RZ-1/4-5/16, 1320RZ-3/8-7/16		
59/S28-4		
6Z-1.1/16-1.1/4, 6Z-1-1.1/8, 6Z-7/8-15/16		
6950SL		
6956		
6958		
6960, 6961		
6966		
6972H		
7407H		
7750SL		
7752		
7760, 7761		
7764		
7765		
7766		
7800DZ-1, 7800DZ-13/16, 7800DZ-7/8		
8164-1/2		
8171		

\* Hasta agotar existencias



Foam para caja de herramientas 1483K y 1483KHD, 13 piezas



### FF3A02

	€		
39 x 210 x 445 mm	277,34	1	FF3A02

BE-3529	
BE-8020L	
BE-8155	
BE-8260	
BE-8601	
BE-8611, BE-8621	
1150-1/2H/P	
1177-SCRIBE	
2047-1.2-8	
2047PR-1-2	
5515T-52	
9715-14-250	

Foam para caja de herramientas 1483K y 1483KHD, 12 piezas



### FF3A03

	€		
48 x 210 x 450 mm	483,16	1	FF3A03

MTB-3-16-M-E	
2101GC-160IP	
2421GC-180IP	
2855 D	
3658A-2, 3658A-3, 3658A-5	
8224CIP	
0454800500, 1151-1, 1151-2, BFLB01	

Foam para caja de herramientas 1483K y 1483KHD, 20 piezas



### FF3A04

	€		
45 x 210 x 445 mm	529,83	1	FF3A04

U-XID1415A, U-XID1618A, U-DS2018A	
1300Z-1/2-9/16, 1300Z-1/4-5/16, 1300Z-3/8-7/16, 1300Z-5/8-3/4, 1300Z-7/8-15/16, 1300Z-25/32-13/16, 1300Z-19/32-11/16	
6Z-19/32-11/16, 6Z-25/32-13/16, 6Z-3/8-7/16, 6Z-5/8-3/4, 6Z-1/4-5/16, 6Z-1/2-9/16	
9070C	
1931Z-7/32, 1931Z-1/4	
8157-15	

Foam para caja de herramientas 1483K y 1483KHD, 95 piezas



### FF3A05

	€		
60 x 245 x 510 mm	1.103,37	1	FF3A05

A6700DZ-1/2, A6700DZ-1/4, A6700DZ-11/32, A6700DZ-3/16, A6700DZ-3/8, A6700DZ-5/16, A6700DZ-7/16, A6700DZ-7/32, A6700DZ-9/16, A6700DZ-9/32	
A6710DZ-1/4, A6710DZ-11/32, A6710DZ-3/8, A6710DZ-5/16, A6710DZ-7/16	
A6800DM-4	
A6800DZ-1/2, A6800DZ-1/4, A6800DZ-11/32, A6800DZ-3/8, A6800DZ-5/16, A6800DZ-7/16, A6800DZ-3/16, A6800DZ-7/32, A6800DZ-9/16, A6800DZ-9/32	

A7400DZ-1/2, A7400DZ-11/16, A7400DZ-13/16, A7400DZ-17/32, A7400DZ-19/32, A7400DZ-3/4, A7400DZ-5/8, A7400DZ-9/16	
59/S28-4	
BE-9780	
KE18-01	
1544	
2058-BR, 7764	
59S/TS-1/4	
6950SL	
6956	
6960, 6962	
6966	
6972H	
7407H	
7752	
7750SL	
7760, 7761	
7765	
7766	
808050	
9071C	
8164-1/2	

Foam para caja de herramientas 1483K y 1483KHD, 15 piezas



### FF3A06

	€		
40 x 205 x 450 mm	294,73	1	FF3A06

BE-8030	
BE-8150, BE-8155	
BE-8260	
BE-8350	
BE-8602	
BE-8610, BE-8620	
1177-SCRIBE	
2047-1-5.5	
2047PR-1-2	
5515T-52	
704Z-3/32	
1150-1/2H/P	
1179-FLX-2	



Foam para caja de herramientas 1483K y 1483KHD, 11 piezas



### FF3A07

	€		
39 x 202 x 450 mm	481,60	1	FF3A07

MTB-3-16-E	
2101GC-160IP	
2427 GC-200IP	
2628 GC-160IP	
2632	
2650	
2855	
3734-3, 3734-5, 3734-8	
8224CIP	

Foam para caja de herramientas 1483K y 1483KHD, 23 piezas



### FF3A08

	€		
43 x 205 x 450 mm	382,94	1	FF3A08

1320RZ-1/2-9/16, 1320RZ-5/16-11/32, 1320RZ-1/4-5/16, 1320RZ-3/8-7/16	
1952Z-1/2, 1952Z-1/4, 1952Z-11/16, 1952Z-11/32, 1952Z-13/16, 1952Z-3/4, 1952Z-3/8, 1952Z-5/16, 1952Z-5/8, 1952Z-7/16, 1952Z-7/8, 1952Z-9/16	
6Z-19/32-11/16, 6Z-1/2-9/16, 6Z-1/4-5/16, 6Z-13/16-7/8, 6Z-3/8-7/16, 6Z-5/16-11/32, 6Z-5/8-3/4	

Foam para caja de herramientas 1483K y 1483KHD, 95 piezas



### FF3A09

	€		
65 x 250 x 515 mm	1.155,92	1	FF3A09

A6800DM-7, A6800DM-6, A6800DM-5.5, A6800DM-11, A6800DM-10, A6800DM-9, A6800DM-8, A6800DM-13, A6800DM-12	
A7402DM-19, A7402DM-18, A7402DM-17, A7402DM-12, A7402DM-11, A7402DM-10, A7402DM-16, A7402DM-15, A7402DM-14, A7402DM-13	

1544	
2058-BR, 6954, 7764	

6700SM-8, 6700SM-7, 6700SM-6, 6700SM-5.5, 6700SM-12, 6700SM-11, 6700SM-10, 6700SM-9, 6700SM-13	
--	--

6709M-8, 6709M-6, 6709M-5, 6709M-4, 6709M-3	
---	--

6709PH-2, 6709PH-1, 6709PH-3	
------------------------------	--

6709TORX-T25, 6709TORX-T20, 6709TORX-T15, 6709TORX-T10, 6709TORX-T40, 6709TORX-T30, 6709TORX-T27, 6709TORX-T9, 6709TORX-T8	
--	--

6950SL	
--------	--

6956	
------	--

6958	
------	--

6960, 6961, 6962, 6962L	
-------------------------	--

6966	
------	--

6972H	
-------	--

7400SM-8, 7400SM-7, 7400SM-6, 7400SM-19, 7400SM-18, 7400SM-17, 7400SM-22, 7400SM-12, 7400SM-11, 7400SM-10, 7400SM-9, 7400SM-16, 7400SM-15, 7400SM-14, 7400SM-13	
---	--

7407H	
-------	--

7409M-10, 7409M-8, 7409M-7, 7409M-6, 7409M-5, 7409M-4, 7409M-3	
--	--

7409TORX-T27, 7409TORX-T25, 7409TORX-T50, 7409TORX-T45, 7409TORX-T40, 7409TORX-T30	
--	--

7750SL	
--------	--

7754, 7760, 7761	
------------------	--

7758	
------	--

7765	
------	--

7766	
------	--

8164-1/2	
----------	--

Foam para caja de herramientas 1483K y 1483KHD, 53 piezas



### FF3A10

	€		
39 x 205 x 445 mm	262,22	1	FF3A10

BE-8020L, BE-8030	
BE-8155	
BE-8260	
BE-8350	
BE-8601, BE-8602	
BE-8610, BE-8620	
BE-9770	
2047-0.8-4	
2047PR-1-2	
808050P	
808050S	
59S/31-1	

Foam para caja de herramientas 1483K y 1483KHD, 12 piezas



### FF3A11

	€		
39 x 205 x 445 mm	348,46	1	FF3A11

1150-1/2H/P	
MTB-3-16	
1177-SCRIBE	
2101GC-160IP	
2427 GC-200IP	
2430 GC-200 IP	
2628 GC-160IP	
3734-3, 3734-5, 3734-8	
3735-4-120	
8224CIP	



Foam para caja de herramientas 1483K y 1483KHD, 28 piezas



### FF3A12

	€		
45 x 205 x 450 mm	379,38	1	FF3A12

111M-6, 111M-21, 111M-19, 111M-18, 111M-22, 111M-13, 111M-12, 111M-11, 111M-10, 111M-17, 111M-16, 111M-15, 111M-14, 111M-9, 111M-8, 111M-7	
2820EF2	
5515T-52	
6M-10-11, 6M-6-7, 6M-12-13, 6M-8-9, 6M-14-15, 6M-16-17, 6M-18-19, 6M-20-22	
BFLA01	
9070C	

Foam para caja de herramientas 1483K y 1483KHD, 49 piezas



### FF3A13

	€		
68 x 245 x 525 mm	694,17	1	FF3A13

111M-27, 111M-32, 111M-24, 111M-30	
6M-24-27, 6M-30-32	
7800SM-19, 7800SM-18, 7800SM-17, 7800SM-16, 7800SM-22, 7800SM-21, 7800SM-11, 7800SM-10, 7800SM-15, 7800SM-14, 7800SM-13, 7800SM-12, 7800SM-27, 7800SM-32, 7800SM-30, 7800SM-24	
7807H	
7809M-10, 7809M-12, 7809M-14, 7809M-19, 7809M-17, 7809M-5, 7809M-8, 7809M-6, 7809M-7	
7809TORX-T50, 7809TORX-T45, 7809TORX-T60, 7809TORX-T55, 7809TORX-T25, 7809TORX-T20, 7809TORX-T40, 7809TORX-T30, 7809TORX-T27	

8150SL	
8164-1/2	
8154-11	
8160-5, 8160-10	
8171	
8166	
8172	

Foam para caja de herramientas 1483K y 1483KHD, 86 piezas



### FF3A14

	€		
65 x 247 x 510 mm	944,84	1	FF3A14

A6700DZ-1/2, A6700DZ-1/4, A6700DZ-3/8, A6700DZ-5/16, A6700DZ-7/16, A6700DZ-7/32, A6700DZ-9/16, A6700DZ-9/32, A6700DZ-11/32	
A6800DZ-1/4, A6800DZ-5/16, A6800DZ-7/32, A6800DZ-9/32	
A7400DM-10, A7400DM-13	
A7400DZ-1/2, A7400DZ-11/16, A7400DZ-13/16, A7400DZ-3/4, A7400DZ-5/8, A7400DZ-7/8, A7400DZ-9/16	
A7402DZ-1/2, A7402DZ-3/8, A7402DZ-7/16, A7402DZ-9/16	
111Z-1, 111Z-1.1/8	
59/S28-4	
6Z-1.1/16-1.1/4, 6Z-1-1.1/8	
6Z/8C	
6950SL	
6958	
6960, 6961	
6966	
6972H	
7407H, 7408H	
7750SL	
7752	
7760, 7761	
7764	
7765	
7766	
7800DZ-1, 7800DZ-15/16	
8164-1/2	
1952Z-15/16	
8171	

Foam para caja de herramientas 1483K y 1483KHD, 14 piezas



### FF3A15

	€		
40 x 210 x 445 mm	267,38	1	FF3A15

BE-3529	
BE-8020L	
BE-8155	
BE-8260	
BE-8601, BE-8602	
BE-8611, BE-8621	
1177-SCRIBE	
2047-1.2-8	
2047PR-1-2	
5515T-52	
1179-FLX-2	
9715-14-250	

Foam para caja de herramientas 1483K y 1483KHD, 12 piezas



### FF3A16

	€		
42 x 210 x 445 mm	475,01	1	FF3A16

MTB-3-16-E	
2101GC-160IP	
2421GC-180IP	
3658A-3, 3658A-5, 3658A-8	
3735-5-120	
3740-150	
8224CIP	
2855 D	
0454800500, BFLB01	

Foam para caja de herramientas 1483K y 1483KHD, 30 piezas



**FF3A17**

	€		
48 x 205 x 450 mm	468,73	1	FF3A17

BE-9780	
KE18-01	
1300Z-1/4-5/16, 1300Z-3/8-7/16	
1320RZ-1/4-5/16, 1320RZ-3/8-7/16	
1931Z-1/4, 1931Z-7/32	
1952Z-1/2, 1952Z-11/16, 1952Z-11/32, 1952Z-13/16, 1952Z-3/4, 1952Z-5/8, 1952Z-7/8, 1952Z-9/16	
2628 GC-180IP	
7758	
U-DS2018A, U-XID1415A, U-XID1618A	

Caja metálica con 69 herramientas en foam



**3149-ORFF1**

	€		
220 x 220 x 560 mm	578,27	1	3149-ORFF1

111M-19, 111M-18, 111M-17, 111M-16, 111M-15, 111M-14, 111M-13, 111M-12, 111M-11, 111M-10, 111M-9, 111M-8	
2953-250	
224 D	
2171G-160	
2470 G-200	
BE-9770	
611-3.5-75, 611-5.5-125, 611-6.5-150	
613-3-100, 613-4-125	
615-2-25, 615-1-100, 615-2-125, 615-3-150	
KBSK-01	
MTG-5-19-E	
482-30	

3625W-28	
3745-150	
3740-150	
3734-3, 3734-5	
3735-5-120	
3149-OR	
2678 G-200	
8160-10, 8160-5	
8158-10	
SBS81	
8166	
7772H	
7800SM-15, 7800SM-16, 7800SM-13, 7800SM-14, 7800SM-19, 7800SM-20, 7800SM-17, 7800SM-18, 7800SM-23, 7800SM-24, 7800SM-21, 7800SM-22, 7800SM-27, 7800SM-32, 7800SM-30, 7800SM-11, 7800SM-12, 7800SM-10	

Caja metálica con 69 herramientas



**3149-ORTS1**

	€		
220 x 220 x 560 mm	383,55	1	3149-ORTS1

111M-19, 111M-18, 111M-17, 111M-16, 111M-15, 111M-14, 111M-13, 111M-12, 111M-11, 111M-10, 111M-9, 111M-8	
S240	
2953-250	
224 D	
2171G-160	
2678 G-200	
2470 G-200	
BE-9770	
611-3.5-75, 611-5.5-125, 611-6.5-150	
613-3-100, 613-4-125	
615-2-25, 615-1-100, 615-2-125, 615-3-150	
KBSK-01	
MTG-5-19-E	
482-30	
3625W-28	
3745-150	
3740-150	
3734-3, 3734-5	
3735-5-120	
3149-OR	

Caja metálica con ruedas



**1497MBW**

		€		
549 x 400 x 1213 mm	250 kg	590,59	1	1497MBW

Caja de herramientas para taller



**3149-OR**

		€		
200 x 220 x 530 mm	4370 g	46,49	1	3149-OR

Caja de herramientas con 7 compartimentos



**1497MBF750**

		€		
250 x 200 x 530 mm	15 kg	80,86	1	1497MBF750





Caja de herramientas con 5 compartimentos



**1497MBF550**

		€		
200 x 200 x 530 mm	12 kg	71,87	1	1497MBF550

Caja metálica de albañil



**1496MB2**

		€		
290 x 290 x 530 mm	40 kg	134,11	1	1496MB2

Caja metálica de albañil



**1496MB5**

		€		
530 x 530 x 910 mm	150 kg	311,43	1	1496MB5

Caja de herramientas con 3 compartimentos



**1497MBF350**

		€		
160 x 200 x 530 mm	10 kg	59,64	1	1497MBF350

Caja metálica de albañil



**1496MB3**

		€		
310 x 360 x 690 mm	60 kg	159,67	1	1496MB3

Caja de herramientas metálica



**1497MB08**

		€		
100 x 170 x 573 mm	30 kg	43,61	1	1497MB08

Caja de herramientas metálica

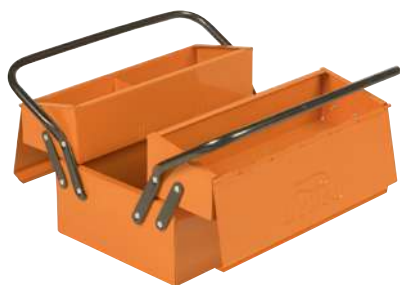

**9601**

		€		
190 x 210 x 300 mm	2450 g	38,19	1	960100010
190 x 210 x 400 mm	3400 g	41,36	1	960100020
190 x 210 x 500 mm	3670 g	44,96	1	960100030
245 x 210 x 400 mm	4400 g	52,90	1	960100050
245 x 210 x 500 mm	4840 g	57,25	1	960100060

Caja metálica de albañil



**1496MB4**

		€		
340 x 440 x 830 mm	80 kg	191,60	1	1496MB4

Caja de herramientas metálica



**1497MB13**

		€		
100 x 230 x 605 mm		60,53	1	1497MB13



Caja de herramientas metálica



**1497MB18**

		€		
122 x 270 x 640 mm	30 kg	66,56	1	1497MB18

Caja de herramientas de plástico



**4750PTB65**

	€		
285 x 300 x 650 mm	64,04	2	4750PTB65

Caja de plástico



**4750BMC**

	€		
51 x 117 x 260 mm	5,21	1	4750BMC3
67 x 214 x 230 mm	9,38	1	4750BMC4
70 x 230 x 280 mm	12,76	1	4750BMC5
90 x 230 x 320 mm	14,16	1	4750BMC5.5
76 x 256 x 355 mm	16,90	1	4750BMC7
80 x 287 x 380 mm	17,26	1	4750BMC9
84 x 341 x 450 mm	23,10	1	4750BMC10

## CAJAS Y ESTUCHES DE PLÁSTICO

Caja de herramientas de plástico sobre ruedas



**4750PTBW67**

		€		
420 x 472 x 675 mm	50 kg	101,69	1	4750PTBW67

Caja plástico con asa 600x305x295



**4750PTB60**

		€		
371	20 kg	57,04	3	4750PTB60

Caja de herramientas de plástico con 37 htas. uso general



**4750PTB65TS5**

	€		
285 x 300 x 650 mm	230,13	1	4750PTB65TS5

Maleta trolley de polipropileno



**4750PTBW47**

		€		
60 l	30 kg	80,61	1	4750PTBW47

Caja plástico con asa 500x295x270



**4750PTB50**

		€		
271	20 kg	49,59	3	4750PTB50

2430 D-140 IP

2630D-160

MT-TS-3

9572

BE-9884

2446

SL25

427-16



Maletín con llave dinamométrica ajustable y juego de herramientas de impacto - 11 piezas



### 4750BMC10FF1

	€		
84 x 341 x 447 mm	509,23	1	4750BMC10FF1

4750BMC10	
BWSHK21	
BWSMB15	
BWSMB17	
BWSS12P5	
BWTVCTT355	
74W9-200	
9R-1/2	

## EQUIPOS TEXTILES Y DE PIEL

Bolsa 4750FB2W-24A con 72 herramientas



### 4750FB2W-TS001

	€		
390 x 400 x 685 mm	690,39	1	4750FB2W-TS001

4750FB2W-24A	
SL25	
BE-8030, BE-8242	
S240	
BE-8155	
BE-8600, BE-8610, BE-8620	
BE-8800, BE-8810, BE-8820	

BE-8040S	
2628 G-180	
2101G-180	
7224	
1520 G	
MTB-5-25	
MA421	
268	
325	
479-16	
KERU-01	
BFLA01	
5515T	
9071	

Bolsa 4750FB2-19A con 61 herramientas para mantenimiento



### 4750FB2-19TS001

		€	
500 mm	250 mm	577,50	1 4750FB2-19TS001

4750FB2-19A	
BE-8010S, BE-8040S, BE-8050S, BE-8220S	
BE-8610S, BE-8620S, BE-8630S	
BE-8800S, BE-8820S, BE-8830S	
706-4	
PC-12-VEN	
1-210-08-2-2	
2101G-180	
2233 D-200	
2628 G-180	
268	
3830-20-VIP, 3830-25-VIP	
3834-ARBR-730	
4130	
424P-16, 424P-20, 424P-25	
428-16	
484-1250	
806-1-1	
8231	
9031	
SL25	

Bolsa 4750FB4-18 con 32 herramientas



### 4750FB4-18TS001

		€	
450 mm	190 mm	767,65	1 4750FB4-18TS001

4750FB4-18	
2101G-160	
2628 G-180	
2430 G-160	
1RM/SH8	
7223	
2233 D-200	
SL25	
9070	
9031	
483-20	
BE-8020, BE-8040	
BE-8150, BE-8155	
BE-8610, BE-8620	
SC127	
SQZ150003	
BE-9777	
MTB-5-25	

Maleta de cuero con 16 herramientas para electricista



### 982000170

	€		
290 x 195 x 440 mm	463,34	1	982000170

Dotación: TS100

4750-FOLTC-1	
2101GC-160IP	
2800 N	
2630GC-160IP	
2421GC-160	
2521GC-160	
8071 C IP	
B196.065.150, B196.055.125, B196.030.100, B196.040.100	
B197.002.100, B197.001.080	
SC127	
2820EF2	
MTB-3-16	
6224	

Maleta cuero con dotación universal 32 htas



**982000320**

	€	
280 x 200 x 435 mm	463,12	1 982000320

4750-FOLTC-1	
2101D-160IP	
224 D	
2630D-180	
2430 D-160 IP	
8071 C IP	
483-20	
6M/8C	
541D-180	
2951-180	
B191.030.075, B191.040.100	
B190.100.200, B190.065.150	
B192.001.100, B192.002.125	
SC127	
2820EF2	
BE-9777	
MTB-3-16	

Maleta de cuero con dotación 34 herramientas electro-mecánico



**982000350**

	€	
280 x 200 x 440 mm	521,86	1 982000350

Dotación: TS002

4750-FOLTC-1	
2101GC-160IP	
2630GC-180IP	
2900-180	
2800-180	
1998M/10T	
8072 C IP	
2951-250	
B190.100.200, B190.065.150, B190.040.100	
B192.001.100, B192.002.125	
SC127	
6M/8C	
479-16	
2430 GC-200 IP	
1-110-08-2-2	
6224	

Estuche porta herramientas con 51 piezas, en foam



**4750FB5BFF1**

	€	
62 x 275 x 330 mm	200,62	1 4750FB5BFF1

4750FB5B	
808050P	

MTB-5-25

2101G-160

2628 G-180

BE-9578

9070

59/S31B

Estuche porta herramientas con 36 piezas



**4750FB5ATS001**

		€	
275 mm	170 mm	135,71	1 4750FB5ATS001

4750FB5A

2058/S26

808050

8070

2101G-160

2628 G-180

Juego/herramientas: electrónica, Alicates



**9848**

	€	
50 x 275 x 330 mm	163,80	1 9848

8160

7890

8070

BE-8020, BE-8040

BE-8610

TL AA-SA-SL





Juego de herramientas para electrónica



**9852**



€



360 x 40 x 240 mm

381,76

1

9852

7890		
8160		
8070		
TL AA-SA-SL		
2421 G-160		
2101G-160		
2628 G-180		
BE-8210, BE-8040		
BE-8150, BE-8155		
BE-8600, BE-8610, BE-8620		
8045LVDE		
K-AP-1		

Juego de herramientas para electrónica



**9841**



€



275 x 48 x 330 mm

181,66

1

9841

7190		
7890		
TL AA-SA-SL		
BE-8020, BE-8040		
BE-8610		
8070		

Mochila para electricistas



**4750FB8**



€



560 x 190 x 335 mm

96,12

4

4750FB8

Bolsa abierta de 19" con cubierta



**4750FB1-19B**



€



365 x 225 x 480 mm

97,52

4

4750FB1-19B

Bolsa de herramientas



**3100TB**



€



345 x 240 x 485 mm

51,18

1

3100TB

Bolsa de 19" con cremallera



**4750FB2-19A**



€



370 x 230 x 470 mm

61,09

4

4750FB2-19A

Bolsa abierta de 19"



**4750FB1-19A**



€



355 x 230 x 470 mm

70,50

1

4750FB1-19A

Bolsa de 24" con cremallera



**4750FB2-24A**



€



380 x 260 x 600 mm

88,12

2

4750FB2-24A



Bolsa de 24" sobre ruedas



**4750FB2W-24A**



€



385 x 325 x 665 mm 173,88 1 4750FB2W-24A

Bolsas portaherramientas textiles con parte superior cerrada de 21 l



**4750FB6-13**



€



275 x 250 x 310 mm 16,91 1 4750FB6-13

Estuche porta herramientas pequeño



**4750FB5A**



€



50 x 168 x 273 mm 10,57 1 4750FB5A

Portaherramientas para electricista de 12"



**4750FB3-12**



€



285 x 190 x 285 mm 72,11 1 4750FB3-12

Bolsas portaherramientas textiles con parte superior cerrada de 36 l



**4750FB6-19**



€



290 x 265 x 480 mm 22,55 1 4750FB6-19

Estuche porta herramientas mediano



**4750FB5B**



€



62 x 275 x 330 mm 18,21 1 4750FB5B

Bolsa de 18" para ordenador portátil y herramientas



**4750FB4-18**



€



350 x 150 x 430 mm 105,74 4 4750FB4-18

Bolsa para juego de niveles 416-SET



**4750-LV-1**



€



85 x 43 x 1800 mm 10,11 1 4750-LV-1  
51 x 43 x 1800 mm 10,11 1 4750-LV-2

Estuche porta herramientas grande



**4750FB5C**



€



80 x 305 x 403 mm 22,91 8 4750FB5C



Porta herramientas compatible con 1 foam 1/3



**4750FB5-FG1**

	€		
65 x 210 x 470 mm	18,36	1	4750FB5-FG1

Maletín para herramientas tubular



**4750-TOCST-1**

	€		
220 x 170 x 495 mm	56,42	1	4750-TOCST-1

Juego de 3 bolsas pequeñas con cremallera



**4750FB7-01**

	€		
135 x 10 x 215 mm	22,68	60	4750FB7-01

Porta herramientas compatible con 2 foams 1/3



**4750FB5-FG2**

	€		
90 x 210 x 470 mm	20,52	1	4750FB5-FG2

Maleta de cuero para electricista



**4750-VDEC**

	€		
290 x 190 x 445 mm	197,96	1	4750-VDEC

Funda de piel negra para tijera de poda



**PROF-TL**

	€		
30 x 90 x 245 mm	20,25	4	PROF-TL

Caja de herramientas de cuero de apertura frontal



**4750-FOLTC-1**

	€		
290 x 195 x 440 mm	148,88	1	4750-FOLTC-1

Juego de cinturón con 3 bolsas



**4750-3PB**

	€		
234 x 105 x 570 mm	89,34	1	4750-3PB-1

Juego de 3 estuches con cremallera



**4750FB7-02**

	€		
205 x 10 x 310 mm	27,00	60	4750FB7-02

Estuche con cremallera, pequeño



### 4750FB7ORLT

	€		
135 x 10 x 215 mm	8,10	120	4750FB7ORLT

Cinturón portaherramientas profesional



### 4750-HDBS-2

	€		
330 x 170 x 900 mm	143,28	1	4750-HDBS-2

Cinturón de cuero resistente



### 4750-HDLB

	€		
47 x 4 x 1380 mm	36,86	1	4750-HDLB-1

Estuche con cremallera, grande



### 4750FB7ORBG

	€		
205 x 10 x 310 mm	9,18	120	4750FB7ORBG

Cinturón ajustable de zafado rápido en tejido muy resistente



### 4750-QRFB-1

	€		
50 x 4 x 1180 mm	21,21	1	4750-QRFB-1

Bolsa con dos bolsillos



### 4750-2PP

	€		
285 x 130 x 265 mm	39,97	1	4750-2PP-1

Cinturón reforzado y acolchado con hebilla de acero inoxidable de doble pitón.



### 4750-HDB-2

	€		
190 x 50 x 900 mm	51,58	1	4750-HDB-2

Cinturón portaherramientas con tres bolsillos Junior



### 4750-JU3PB

	€		
125 x 55 x 395 mm	32,86	1	4750-JU3PB-1

Porta taladro para diestros y zurdos



### 4750-DHO-3

	€		
320 x 73 x 175 mm	32,67	1	4750-DHO-3



Portaherramientas electricista



**4750-EP**

	€		
345 x 120 x 260 mm	52,35	1	4750-EP-1

Funda vertical para móvil



**4750-VMPH-1**

	€		
170 x 35 x 100 mm	17,67	1	4750-VMPH-1

Tirantes con pinzas



**4750-BWC-1**

	€		
750 x 20 x 105 mm	24,30	1	4750-BWC-1

Soporte porta herramientas multi uso



**4750-MPH-1**

	€		
240 x 50 x 155 mm	24,37	1	4750-MPH-1

Portaherramientas enrollable



**4750-ROCO-1**

	€		
320 x 5 x 370 mm	20,72	1	4750-ROCO-1

Funda para cutter de hoja deslizante



**4750-KNHO-1**

	€		
205 x 35 x 105 mm	16,44	1	4750-KNHO-1

Rodilleras con almohadillas



**4750-KP**

	€		
200 x 30 x 170 mm	45,76	1	4750-KP-1



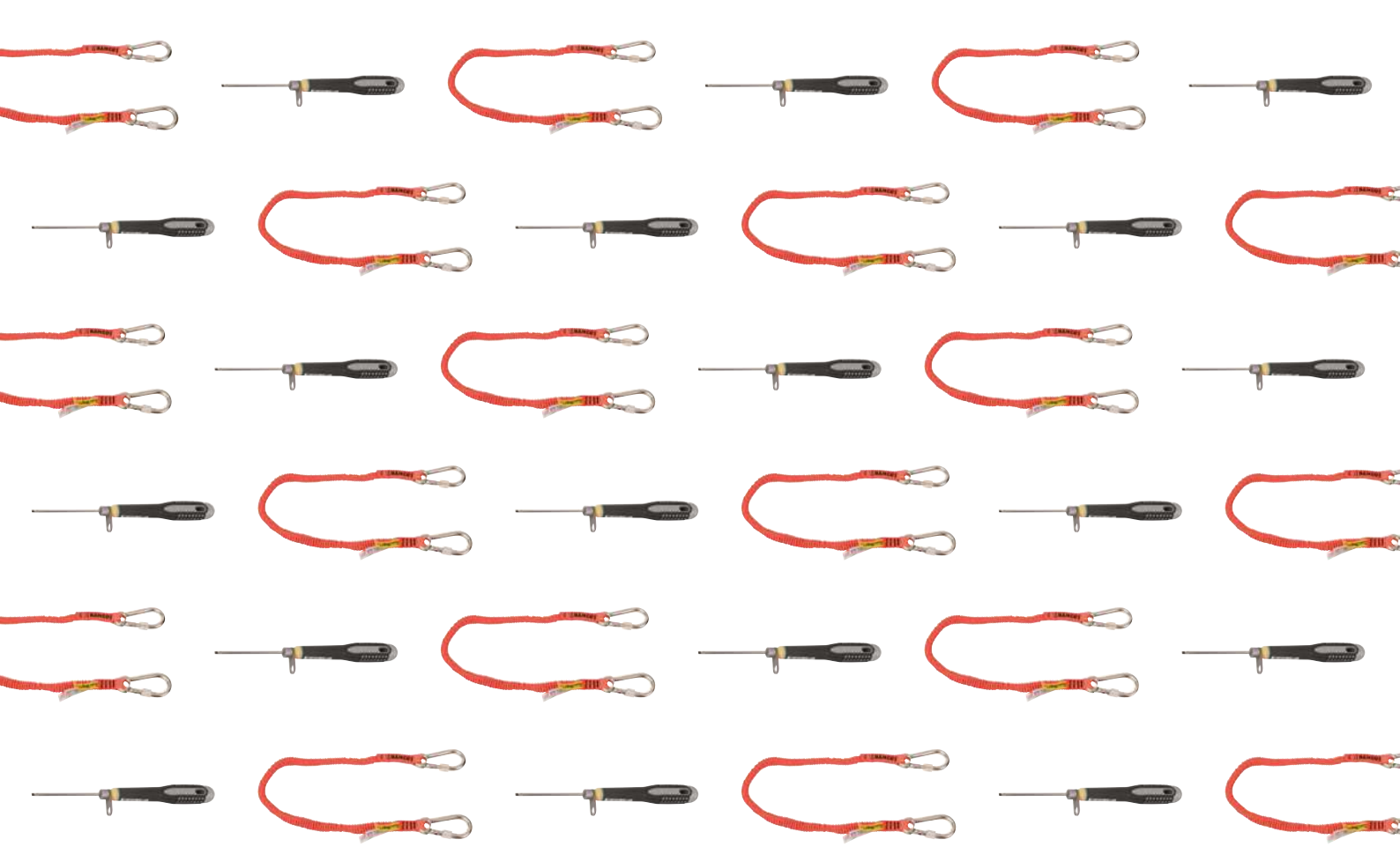

## Herramientas para trabajos en altura



## ALMACENAMIENTO DE HERRAMIENTAS Y CORDONES

Lanyard para 1Kg con mosquetones giratorios



**3875-LY60**



<b>g</b>	€		
135 g	26,10	1	3875-LY600

Cordón flexible máx 1kg largo 65cm



**3875-LY3**

<b>g</b>	€		
125 g	40,43	8	3875-LY3

Longitud máx.: 120cm

Cordón para muñecas (1daN) 60cm



**3875-WL1**

<b>g</b>	€		
40 g	26,39	8	3875-WL1

Cordón conector para 3875-LY3 o 3875-WL1



**3875-QL1**

<b>g</b>	€		
40 g	15,46	8	3875-QL1

Cordón flexible máx 0.9Kg



**3875-RL1**

<b>g</b>	€		
200 g	70,11	1	3875-RL1

Longitud máx 100cm

Cordón conector para 3875-RL1



**3875-QRL1**

<b>g</b>	€		
40 g	20,15	1	3875-QRL1

Lanyard para 1Kg retráctil



**3875-RL2**

<b>g</b>	€		
212 g	70,37	1	3875-RL2

Lanyard para 3Kg con mosquetones fijos



**3875-LY70**



<b>g</b>	€		
172 g	25,62	1	3875-LY70

Cuerda de seguridad flexible con mosquetón fijo (3daN)



**3875-LY2**

<b>g</b>	€		
120 g	40,43	8	3875-LY2

Largura 80cm, máx 120cm

Lanyard para 6Kg con mosquetones fijos



**3875-LY8**



<b>g</b>	€		
330 g	59,10	1	3875-LY8*

Lanyard para 12Kg con mosquetones fijos



**3875-LY10**



	€		
270 g	70,37	1	3875-LY10*

Cuerda de acero



**3875-SL1**

	€		
10 g	0,70	1	3875-SL1

Bolsa para trabajos en altura, 10 litros, carga máxima de 1Kg



**3875-HB10**

	€		
260 x 130 x 130 mm	9,15	1	3875-HB10*

Porta herramientas hast 25kg



**439000000**

	€		
100 g	13,14	1	439000000

Lanyard para 3Kg con mosquetones giratorios



**439000003**

	€		
160 g	24,12	1	439000003*

Bolsa colgante para 30 y 60 litros



**3875-HB30/3875-HB60**

	€		
270 x 270 x 330 mm	94,00	1	3875-HB30
340 x 340 x 620 mm	117,54	6	3875-HB60

Lanyard espiral 1.7mm



**439000001**

	€		
130 g	13,30	1	439000001

Cordones lanyard naranjas de alta visibilidad con clip de plástico



**439000004**

	€		
13 g	7,32	1	439000004*

Bolsa 100 l. para trabajos en altura



**3875-HB100**

	€		
390 x 390 x 890 mm	189,99	1	3875-HB100

\* Hasta agotar existencias



Bolsa para maleta rígida



**3875-SB70**

790 x 300 x 750 mm    € 260,36    1    3875-SB70

Jgo de cinturón con 3 bolsas



**3PB-2**

80 x 270 x 1350 mm    € 133,21    1    4750-3PB-2

Soporte para martillo



**4750-HHO-2**

110 x 65 x 165 mm    € 22,11    1    4750-HHO-2

Mochila grande con múltiples compartimentos



**3875-BP2**

240 x 340 x 440 mm    € 131,64    10    3875-BP2

Bolsa para flexómetros de 5 y 8 m con anilla



**4750-MTHO-TAH**

80 x 110 x 165 mm    € 15,58    1    4750-MTHO-TAH

Cinturón de cuero resistente



**4750-HDLB-TAH**

50 x 120 x 1410 mm    € 63,43    1    4750-HDLB-TAH

Bolsa con 6 ganchos



**3875-MHP6**

100 x 185 x 370 mm    € 93,52    1    3875-MHP6

Bolsa universal



**4750-UP-2**

270 x 145 x 270 mm    € 62,61    1    4750-UP-2

## LLAVES PARA TRABAJOS EN ALTURA

Llave ajustable serie 90



ergo®



**TAH90**

158mm/6"    20 mm    € 45,93    1    TAH9070  
250mm/10"    31 mm    € 64,93    1    TAH9072



### Llave ajustable serie 80



#### TAH80



L	W	€	Icon	Icon
110mm/4"	13 mm	54,23	1	TAH8069
155mm/6"	20 mm	52,21	1	TAH8070
205mm/8"	27 mm	56,33	1	TAH8071
255mm/10"	31 mm	52,31	1	TAH8072
305mm/12"	34 mm	75,99	1	TAH8073
380mm/15"	44 mm	124,22	1	TAH8074
460mm/18"	53 mm	195,16	1	TAH8075
110mm/4"	13 mm	56,64	1	TAH8069C*
155mm/6"	20 mm	40,55	1	TAH8070C*
205mm/8"	27 mm	41,99	1	TAH8071C*
255mm/10"	31 mm	46,04	1	TAH8072C*
305mm/12"	34 mm	55,96	1	TAH8073C*
380mm/15"	44 mm	93,52	1	TAH8074C*
460mm/18"	53 mm	133,78	1	TAH8075C*

### Llave Podger con anilla de seguridad



#### TAH84



L	W	€	Icon	Icon
405mm/16"	41 mm	54,03	1	TAH84-PODGER

### Llave combinada con muelle de seguridad



#### TAH111M



L	W	€	Icon	Icon
6 mm	112 mm	14,61	1	TAH111M-6
7 mm	120 mm	14,64	1	TAH111M-7
8 mm	130 mm	14,67	1	TAH111M-8
9 mm	136 mm	14,72	1	TAH111M-9
10 mm	144 mm	14,76	1	TAH111M-10
11 mm	153 mm	15,00	1	TAH111M-11
12 mm	160 mm	15,42	1	TAH111M-12
13 mm	165 mm	15,45	1	TAH111M-13

### Llave combinada con carraca con muelle de seguridad



#### TAH11RM



L	W	€	Icon	Icon
6 mm	128 mm	29,81	1	TAH11RM-6
7 mm	140 mm	29,81	1	TAH11RM-7
8 mm	140 mm	29,94	1	TAH11RM-8
9 mm	150 mm	30,98	1	TAH11RM-9
10 mm	159 mm	31,09	1	TAH11RM-10
11 mm	165 mm	32,80	1	TAH11RM-11
12 mm	172 mm	33,70	1	TAH11RM-12
13 mm	178 mm	32,83	1	TAH11RM-13
14 mm	191 mm	37,26	1	TAH11RM-14
15 mm	200 mm	38,29	1	TAH11RM-15
16 mm	208 mm	39,19	1	TAH11RM-16
17 mm	226 mm	39,19	1	TAH11RM-17
18 mm	237 mm	40,46	1	TAH11RM-18
19 mm	248 mm	42,27	1	TAH11RM-19
21 mm	290 mm	52,32	1	TAH11RM-21
22 mm	361 mm	50,63	1	TAH11RM-22
24 mm	323 mm	54,96	1	TAH11RM-24
27 mm	359 mm	83,30	1	TAH11RM-27
30 mm	400 mm	98,40	1	TAH11RM-30
32 mm	425 mm	109,18	1	TAH11RM-32

### Llave combinada en pulgadas con muelle de seguridad



#### TAH111Z



L	W	€	Icon	Icon
5/16 in	130 mm	16,90	1	TAH111Z-5/16*
3/8 in	140 mm	19,73	1	TAH111Z-3/8*
1/2 in	169 mm	20,89	1	TAH111Z-1/2*
9/16 in	177 mm	21,50	1	TAH111Z-9/16*
5/8 in	195 mm	22,62	1	TAH111Z-5/8*
11/16 in	200 mm	22,32	1	TAH111Z-11/16*
13/16 in	250 mm	29,75	1	TAH111Z-13/16*
7/8 in	250 mm	31,32	1	TAH111Z-7/8*
15/16 in	270 mm	31,88	1	TAH111Z-15/16*
1 in	290 mm	34,48	1	TAH111Z-1*
1-1/16 in	310 mm	35,86	1	TAH111Z-1.1/16*
1-1/8 in	310 mm	39,62	1	TAH111Z-1.1/8*
1-1/4 in	350 mm	41,85	1	TAH111Z-1.1/4*
1-5/16 in	350 mm	53,11	1	TAH111Z-1.5/16*
1 3/8 in	410 mm	74,70	1	TAH111Z-1.3/8*
1 7/16 in	410 mm	74,70	1	TAH111Z-1.7/16*
1 1/2 in	410 mm	74,69	1	TAH111Z-1.1/2*
1 5/8 in	460 mm	102,64	1	TAH111Z-1.5/8*
1 11/16 in	460 mm	106,84	1	TAH111Z-1.11/16*
1 3/4 in	500 mm	124,10	1	TAH111Z-1.3/4*
1 13/16 in	500 mm	126,74	1	TAH111Z-1.13/16*
1 7/8 in	540 mm	157,24	1	TAH111Z-1.7/8*
2 in	540 mm	157,82	1	TAH111Z-2*
2 1/4 in	600 mm	396,40	1	TAH111Z-2.1/4*
2 3/8 in	600 mm	396,40	1	TAH111Z-2.3/8*
2 5/8 in	680 mm	522,13	1	TAH111Z-2.5/8*
2 3/4 in	680 mm	536,51	1	TAH111Z-2.3/4*
2 7/8 in	730 mm	704,37	1	TAH111Z-2.7/8*
3 in	730 mm	728,85	1	TAH111Z-3*

### Llaves de estrella acodadas, mm con muelle deslizante de acero inoxidable



#### TAH2M



L	W	€	Icon	Icon
6x7 mm	165 mm	51,64	1	TAH2M-6-7*
8x9 mm	180 mm	53,74	1	TAH2M-8-9*
10x11 mm	190 mm	54,66	1	TAH2M-10-11*
12x13 mm	210 mm	55,28	1	TAH2M-12-13*
14x15 mm	226 mm	56,70	1	TAH2M-14-15*
16x17 mm	246 mm	58,06	1	TAH2M-16-17*
18x19 mm	266 mm	59,97	1	TAH2M-18-19*

\* Hasta agotar existencias



Llave fija, mm., con muelle de seguridad



**TAH6M**



	L	€		
6x7 mm	122 mm	14,16	1	TAH6M-6-7
8x9 mm	135 mm	14,78	1	TAH6M-8-9
10x11 mm	153 mm	17,24	1	TAH6M-10-11
12x13 mm	164 mm	17,67	1	TAH6M-12-13
14x15 mm	183 mm	17,93	1	TAH6M-14-15
16x17 mm	201 mm	18,29	1	TAH6M-16-17
17x19 mm	222 mm	21,06	1	TAH6M-17-19
18x19 mm	222 mm	21,17	1	TAH6M-18-19
20x22 mm	225 mm	25,83	1	TAH6M-20-22
24x27 mm	260 mm	45,23	1	TAH6M-24-27
30x32 mm	300 mm	52,43	1	TAH6M-30-32

Llave para racores con muelle de seguridad



**TAH1949M**



	L	€		
8x9 mm	140 mm	30,69	1	TAH1949M-8-9*
10x11 mm	150 mm	30,69	1	TAH1949M-10-11*
12x14 mm	170 mm	34,39	1	TAH1949M-12-14*
14x17 mm	200 mm	34,39	1	TAH1949M-14-17*
19x22 mm	220 mm	47,03	1	TAH1949M-19-22*
24x27 mm	255 mm	68,01	1	TAH1949M-24-27*

Llave de impacto boca estrella con argolla



**TAH7444SG**



	L	€		
36 mm	205 mm	68,62	1	TAH7444SG-M-36
41 mm	230 mm	87,59	1	TAH7444SG-M-41
46 mm	240 mm	96,03	1	TAH7444SG-M-46
50 mm	255 mm	107,95	1	TAH7444SG-M-50
55 mm	270 mm	123,45	1	TAH7444SG-M-55

Llaves de pipa acodadas 6 x 6-Point Dynamic-Drive™ con anillo de acero inoxidable



**TAH29**



	€		
6 mm	79,43	1	TAH29M-6*
7 mm	80,72	1	TAH29M-7
8 mm	82,00	1	TAH29M-8
9 mm	82,00	1	TAH29M-9*
10 mm	82,00	1	TAH29M-10
11 mm	82,65	1	TAH29M-11*
12 mm	82,65	1	TAH29M-12*
13 mm	82,65	1	TAH29M-13
14 mm	82,65	1	TAH29M-14*
15 mm	82,65	1	TAH29M-15*
16 mm	82,65	1	TAH29M-16*
17 mm	83,28	1	TAH29M-17*
18 mm	83,28	1	TAH29M-18*
19 mm	83,28	1	TAH29M-19*
20 mm	83,28	1	TAH29M-20*
21 mm	86,93	1	TAH29M-21*
22 mm	86,93	1	TAH29M-22*
23 mm	87,58	1	TAH29M-23*
24 mm	92,30	1	TAH29M-24*
25 mm	92,98	1	TAH29M-25*
26 mm	98,03	1	TAH29M-26*
27 mm	96,91	1	TAH29M-27*
28 mm	100,56	1	TAH29M-28*
29 mm	105,24	1	TAH29M-29*
30 mm	108,01	1	TAH29M-30*
32 mm	113,19	1	TAH29M-32*

Llave universal 5 en 1 con cuerda dyneema para trabajos en altura



**TAHMK5**



L	€		
97x25 mm	45,73	1	TAHMK5

Llave de chicharra equipada con un anillo de seguridad para 13 a 22 tamaños



**TAHSC2RM**



	L	€		
13-17 mm	280 mm	56,33	1	TAHSC2RM-13-17
15-17 mm	280 mm	68,69	1	TAHSC2RM-15-17
19-22 mm	310 mm	75,57	1	TAHSC2RM-19-22
27-30 mm	450 mm	123,65	1	TAHSC2RM-27-30

**LLAVES PARA TUBOS TRABAJOS EN ALTURA**

Llave de tubo modelo sueco de 90°, con lazo de seguridad



**TAH1410-TAH1420**



L		€		
320 mm	1 in	90,67	1	TAH1410
430 mm	1 1/2 in	100,30	1	TAH1420

Llave de tubo modelo sueco de 90°, con lazo de seguridad



**TAH14**



L	mm	in	€	Icon 1	Icon 2
210 mm	3/4 in	74,20	1	TAH140	
320 mm	1 in	80,89	1	TAH141	
426 mm	1 1/2 in	105,96	1	TAH142	
557 mm	2-1/2 in	151,14	1	TAH143	

Cortatubos 3mm-28mm con Anilla de Acero Inoxidable



**TAH401-28**



Ø	€	Icon 1	Icon 2
3-28 mm	38,69	1	TAH401-28*

Escariador de ruedas de plástico con cuerda de Kevlar



**TAH317-40**



Ø	€	Icon 1	Icon 2
3-40	28,22	1	TAH317-40*

Llave Stillson de aluminio con anilla



**TAH380**



L	mm	in	€	Icon 1	Icon 2
253 mm	1.1/2 in	73,27	1	TAH380-10	
354 mm	2 in	97,41	1	TAH380-14	
455 mm	2.1/2 in	139,11	1	TAH380-18	
607 mm	3 in	206,37	1	TAH380-24	

Cortatubos 3mm-35mm con Anillo de Acero Inoxidable



**TAH402-35**



Ø	€	Icon 1	Icon 2
3-35 mm	60,53	1	TAH402-35*

**LLAVES DE VASO Y CARRACAS TRABAJOS EN ALTURA**

Vasos hex 1/4" con solución en 4 puntos



**TAH08**



Ø	€	Icon 1	Icon 2
5.5 mm	6,66	1	TAH08-5.5
6 mm	6,66	1	TAH08-6
7 mm	6,66	1	TAH08-7
8 mm	6,66	1	TAH08-8
9 mm	6,66	1	TAH08-9
10 mm	6,66	1	TAH08-10
11 mm	6,66	1	TAH08-11
12 mm	6,66	1	TAH08-12
13 mm	6,66	1	TAH08-13

Cortatubos 3mm-16mm con Anillo de Acero Inoxidable



**TAH401-16**



Ø	€	Icon 1	Icon 2
3-16 mm	36,72	1	TAH401-16*

Cortatubos con anilla de acero inoxidable



**TAH302-35**



Ø	€	Icon 1	Icon 2
3-35 mm	38,11	1	TAH302-35*

Mango articulado 1/4" con muelle de seguridad



**TAH6958B-1**



L	€	Icon 1	Icon 2
150 mm	45,63	1	TAH6958B-1

\* Hasta agotar existencias



Alargadera 1/4" con solución en 4 puntos



**TAH6960-TAH6962L**

L	€		
50 mm	12,26	1	TAH6960
101 mm	13,30	1	TAH6961
152 mm	17,00	1	TAH6962
355 mm	38,77	1	TAH6962L

Vasos 1/4" para punta PH con solución en 4 puntos



**TAH08-PH**

	€		
1	9,68	1	TAH08-PH1
2	9,68	1	TAH08-PH2
3	9,68	1	TAH08-PH3

Portavasos 1/4" con cuello de seguridad



**TAH6956-1**

L	€		
150 mm	15,60	1	TAH6956-1

Articulación universal 1/4" con solución en 4 puntos



**TAH6966**

L	€		
36 mm	30,69	1	TAH6966

Vasos 1/4" para punta TORX® con solución en 4 puntos



**TAH08TTAH**

	€		
T-8	10,90	1	TAH08-T8
T-9	10,90	1	TAH08-T9
T-10	10,90	1	TAH08-T10
T-15	10,90	1	TAH08-T15
T-20	10,90	1	TAH08-T20
T-25	11,26	1	TAH08-T25
T-27	11,26	1	TAH08-T27
T-30	11,26	1	TAH08-T30
T-40	11,26	1	TAH08-T40

Vasos bihex. 1/2" con solución en 4 puntos



Vasos 1/4" punta hexagonal con solución en 4 puntos



**TAH08-H**

	€		
3 mm	8,76	1	TAH08-H3
4 mm	8,76	1	TAH08-H4
5 mm	8,76	1	TAH08-H5
6 mm	8,76	1	TAH08-H6
8 mm	8,76	1	TAH08-H8

Carraca 1/4, 72 dientes/5° ángulo de acción, con cuerda Dyneema



**TAH6950**

L	€		
120 mm	52,74	1	TAH6950

**TAH16B**

	€		
8 mm	9,16	1	TAH16B-8*
10 mm	8,46	1	TAH16B-10
11 mm	8,46	1	TAH16B-11
12 mm	8,96	1	TAH16B-12
13 mm	9,35	1	TAH16B-13
14 mm	9,82	1	TAH16B-14
15 mm	10,20	1	TAH16B-15
16 mm	10,39	1	TAH16B-16
17 mm	10,79	1	TAH16B-17
18 mm	10,79	1	TAH16B-18
19 mm	11,24	1	TAH16B-19
21 mm	11,85	1	TAH16B-21
22 mm	12,27	1	TAH16B-22
24 mm	13,83	1	TAH16B-24
25 mm	14,04	1	TAH16B-25
27 mm	14,75	1	TAH16B-27
30 mm	16,41	1	TAH16B-30
32 mm	16,74	1	TAH16B-32



Vaso bihex. 1/2" con solución en cuatro puntos



**TAH16B"**

	€		
1/2 in	9,60	1	TAH16B-1/2
9/16 in	10,23	1	TAH16B-9/16
5/8 in	10,79	1	TAH16B-5/8
11/16 in	11,11	1	TAH16B-11/16
3/4 in	11,64	1	TAH16B-3/4
13/16 in	12,27	1	TAH16B-13/16
7/8 in	12,69	1	TAH16B-7/8*
15/16 in	14,33	1	TAH16B-15/16*
1 in	14,33	1	TAH16B-1
1 1/16 in	17,25	1	TAH16B-1.1/16
1 1/8 in	17,25	1	TAH16B-1.1/8
1 1/4 in	17,26	1	TAH16B-1.1/4

Junta universal 1/2" con solución en cuatro puntos



**TAH8166**

L	€		
67 mm	42,81	1	TAH8166

	€		
7/16 in	17,03	1	TAH16H-7/16
1/2 in	17,98	1	TAH16H-1/2
9/16 in	18,43	1	TAH16H-9/16
5/8 in	18,91	1	TAH16H-5/8

Vasos con punta 1/2" TORX® con solución en cuatro puntos



**TAH16-T**

	€		
T30	19,12	1	TAH16-T30
T40	22,32	1	TAH16-T40
T45	22,32	1	TAH16-T45*
T50	22,32	1	TAH16-T50
T55	27,94	1	TAH16-T55
T60	27,94	1	TAH16-T60

Mango articulado 1/2" con muelle de seguridad



**TAH8158B-1**

L	€		
256 mm	110,09	1	TAH8158B-1

Vaso con punta 1/2" hex. con solución en cuatro puntos



**TAH16H**

	€		
4 mm	16,86	1	TAH16-H4
5 mm	16,86	1	TAH16-H5
6 mm	16,86	1	TAH16-H6
7 mm	16,86	1	TAH16-H7
8 mm	18,26	1	TAH16-H8
10 mm	18,26	1	TAH16-H10
12 mm	18,69	1	TAH16-H12
14 mm	20,50	1	TAH16-H14
17 mm	19,65	1	TAH16-H17
19 mm	20,20	1	TAH16-H19

Destornilladores de vaso con cuadradillo de 1/2" para tornillos métricos de cabeza hexagonal con solución de 4 puntas



**TAH7809M**

		€		
10 mm	23 mm	30,50	1	TAH7809M-10-140*
8 mm	23 mm	29,60	1	TAH7809M-8-120*

Alargadera 1/2" con solución en cuatro puntos



**TAH8160-8162**

L	€		
125 mm	84,31	1	TAH8160
250 mm	103,56	1	TAH8162

Vasos con punta 1/2" hex. con solución en cuatro puntos



**TAH16H"**

	€		
1/4 in	16,54	1	TAH16H-1/4
5/16 in	16,54	1	TAH16H-5/16
3/8 in	16,54	1	TAH16H-3/8

\* Hasta agotar existencias



Destornilladores de vaso de 1/2" cuadrado para tornillo de cabeza multipunto con solución de 4 puntas



**TAH7809XZN**



	€		
10	32,02	1	TAH7809XZN-10
12	33,94	1	TAH7809XZN-12
14	33,94	1	TAH7809XZN-14
16	35,24	1	TAH7809XZN-16
18	35,38	1	TAH7809XZN-18
6	32,36	1	TAH7809XZN-6
8	32,02	1	TAH7809XZN-8

Juego de vasos 1/2" con carraca tipo pera - 17 piezas



**TAH16BZ/17**



	€		
80 x 300 x 380 mm	442,69	1	TAH16BZ/17*

Mango universal 3/4" con cuerda de alambre



**TAH8953**



	€		
500 mm	57,76	1	TAH8953*

Carraca reversible 1/2" - 80 dientes/ 4.5° ángulo de acción, con cuerda Dyneema



**TAH8150-1/2**



	€		
270 mm	84,27	1	TAH8150-1/2

Vasos bihex. 3/4" con solución de 4 puntos



**TAH24B**



	€		
27 mm	25,95	1	TAH24B-27
30 mm	29,12	1	TAH24B-30
32 mm	30,32	1	TAH24B-32
36 mm	35,05	1	TAH24B-36
38 mm	37,33	1	TAH24B-38
41 mm	41,13	1	TAH24B-41
46 mm	48,53	1	TAH24B-46
50 mm	54,84	1	TAH24B-50

Cabeza de carraca reversible 3/4", con cuerda de alambre



**TAH8950N/A**



	€		
170 mm	209,92	1	TAH8950N/A*

Juego de vasos 1/2" con carraca tipo pera - 22 piezas



**TAH16BM/22**



	€		
85 x 350 x 445 mm	514,09	1	TAH16BM/22

Alargaderas 3/4" con 4 puntos



**TAH8961**

	€		
200 mm	50,69	1	TAH8961

Liberador de pin para vasos TAH



**TAHPINRELEASER**



	€		
4 mm	49,42	1	TAHPINRELEASER

## DESTORNILLADORES PARA TRABAJOS EN ALTURA

Destornillador ERGO™ boca recta con placa de inserción



ergo



### TAHE8020L-TAHE8252



Bit	Length	Price (€)	Quantity	Model
3.2 mm	75 mm	19,84	1	TAHE-8020L
3.5 mm	75 mm	20,38	1	TAHE-8030
4 mm	100 mm	21,30	1	TAHE-8040
5.5 mm	150 mm	24,92	1	TAHE-8241
6.5 mm	150 mm	29,19	1	TAHE-8252

Destornillador ERGO™ boca plana con cuerda Dyneema



ergo



### TAHE8155



Bit	Length	Price (€)	Quantity	Model
6 mm	125 mm	30,86	1	TAHE-8155
8 mm	175 mm	36,19	1	TAHE-8257
10 mm	210 mm	38,63	1	TAHE-8258

Destornillador ERGO™ boca plana con cuerda Dyneema



ergo



### TAHE8260



Bit	Length	Price (€)	Quantity	Model
9 mm	175 mm	42,00	1	TAHE-8260
12 mm	200 mm	55,20	1	TAHE-8880

Destornillador stubby ERGO™ boca recta con cuello de seguridad



ergo



### TAHE-8350

Bit	Length	Price (€)	Quantity	Model
5.5 mm	28 mm	22,36	1	TAHE-8350

Destornilladores stubby ERGO™ PH con cuello de seguridad



ergo



### TAHE-8602

Bit	Length	Price (€)	Quantity	Model
PH2	30 mm	24,74	1	TAHE-8602

Destornilladores ERGO™ PH con cuello de seguridad



ergo



### TAHE8610-TAHE8624

Bit	Length	Price (€)	Quantity	Model
PH 1	75 mm	24,56	1	TAHE-8611
PH 1	75 mm	24,42	1	TAHE-8610
PH 2	100 mm	28,39	1	TAHE-8620
PH 2	200 mm	31,97	1	TAHE-8620L
PH 3	150 mm	36,05	1	TAHE-8623
PH 4	190 mm	41,19	1	TAHE-8624

Destornilladores ERGO™ PZ con cuello de seguridad



ergo



### TAHE8810-TAHE8820

Bit	Length	Price (€)	Quantity	Model
PZ 1	73 mm	26,05	1	TAHE-8810
PZ 2	100 mm	29,87	1	TAHE-8820

Destornilladores ERGO™ PH con cuerda Dyneema



ergo



### TAHE-8630

Bit	Length	Price (€)	Quantity	Model
PH 3	155 mm	43,90	1	TAHE-8630

Destornilladores ERGO™ PZ varilla hexagonal con cuerda Dyneema



ergo



### TAHE-8830

Bit	Length	Price (€)	Quantity	Model
PZ 3	150 mm	43,90	1	TAHE-8830

\* Hasta agotar existencias



Destornillador ERGO™ para tornillos TORX® con placa de inserción



ergo



**TAHBE8910-TAHBE8930**



Icon	Icon	€	Icon	Icon
T10	2.72 mm	27,92	1	TAHBE-8910
T15	3.26 mm	28,85	1	TAHBE-8915
T20	3.84 mm	30,22	1	TAHBE-8920
T25	4 mm	31,60	1	TAHBE-8925
T30	6 mm	32,98	1	TAHBE-8930

Destornillador ERGO™ aislado para tornillos TORX®



ergo



**TAHBE8910S-TAHBE8930S**

Icon	Icon	€	Icon	Icon
T10	2.5 mm	20,61	1	TAHBE-8910S
T15	3.26 mm	26,10	1	TAHBE-8915S
T20	3.84 mm	30,92	1	TAHBE-8920S
T25	4.4 mm	32,98	1	TAHBE-8925S
T30	5.49 mm	34,35	1	TAHBE-8930S

Destornilladores Phillips de precisión con anilla de acero inoxidable



**TAH701**

Icon	Icon	€	Icon	Icon
PH00	137 mm	56,12	1	TAH701-00-50
PH 0	137 mm	56,12	1	TAH701-0-50

Destornilladores aislado ERGO™ boca plana con cuerda Kevlar



ergo



**TAHBE8040S-TAHBE8050S**

Icon	Icon	€	Icon	Icon
3.0 mm	100 mm	11,18	1	TAHBE-8220S
4.0 mm	100 mm	13,55	1	TAHBE-8040S
5.5 mm	125 mm	16,17	1	TAHBE-8050S
6.5 mm	155 mm	20,68	1	TAHBE-8255S

Destornilladores Pozidriv aislados VDE y delgados ERGO™ con mango de tres componentes, con muelle Kevlar



ergo



**TAHBE-8820SL**

Icon	Icon	€	Icon	Icon
PZ 2	PZ 2	22,34	1	TAHBE-8820SL

Destornilladores TORX® de precisión con anilla de acero inoxidable



**TAH703**

Icon	Icon	€	Icon	Icon
T 6	137 mm	56,27	1	TAH703-6-50
T 7	137 mm	56,27	1	TAH703-7-50
T 8	137 mm	56,27	1	TAH703-8-50
T 9	137 mm	56,32	1	TAH703-9-50
T 10	137 mm	56,24	1	TAH703-10-50
T 15	162 mm	56,45	1	TAH703-15-75

Destornilladores aislados ERGO™ PH con cuerda Kevlar



ergo



**TAHBE8610S-TAHBE8620S**

Icon	Icon	€	Icon	Icon
PH1	80 mm	14,38	1	TAHBE-8610S
PH2	100 mm	18,56	1	TAHBE-8620S
PH3	150 mm	23,78	1	TAHBE-8630S
PH4	190 mm	35,21	1	TAHBE-8640S

Destornilladores planos de precisión con anilla de acero inoxidable



**TAH700**

Icon	Icon	€	Icon	Icon
1.5 mm	137 mm	56,07	1	TAH700-1.5-50
1.8 mm	137 mm	56,07	1	TAH700-1.8-50
2.5 mm	137 mm	56,57	1	TAH700-2.5-50
3 mm	187 mm	56,57	1	TAH700-3-100

Destornilladores hexagonales con mango en T y cordón de Dyneema



**TAH900T**

Icon	Icon	€	Icon	Icon
2	100 mm	37,00	1	TAH900T-020-100
2.5	100 mm	37,00	1	TAH900T-025-100
3 mm	100 mm	37,00	1	TAH900T-030-100
4	138 mm	37,50	1	TAH900T-040-150
5 mm	138 mm	37,50	1	TAH900T-050-150
6 mm	185 mm	38,50	1	TAH900T-060-200
8 mm	185 mm	39,50	1	TAH900T-080-200
10 mm	185 mm	41,50	1	TAH900T-100-200



Destornillador TORX® con mango en T y cordón de Dyneema



**TAH901T**

			€		
T 6	100 mm	32,00	1	TAH901T-006-100	
T 7	100 mm	32,00	1	TAH901T-007-100	
T 8	100 mm	32,00	1	TAH901T-008-100	
T 9	100 mm	32,00	1	TAH901T-009-100	
T 10	100 mm	32,00	1	TAH901T-010-100	
T 15	138 mm	33,00	1	TAH901T-015-150	
T 20	138 mm	33,00	1	TAH901T-020-150	
T 25	138 mm	33,00	1	TAH901T-025-150	
T 27	138 mm	33,00	1	TAH901T-027-150	
T 30	185 mm	34,00	1	TAH901T-030-200	
T 40	185 mm	35,00	1	TAH901T-040-200	
T 45	185 mm	35,60	1	TAH901T-045-200	
T 50	185 mm	37,50	1	TAH901T-050-200	

Llaves tipo "allen" fosfatadas métricas con anilla de acero inoxidable, 7 piezas



**TAHBE-9776**

	€		
7 1.5 2 2.5 3 4 5 6 mm	49,88	1	TAHBE-9776

Llave acodada doble con alambre de acero



**TAH2047**

		€		
4.0 mm	100 mm	28,81	1	TAH2047-0.8-4

Llaves tipo "allen" fosfatadas métricas con anilla de acero inoxidable



**TAH1995M**

		€		
8 mm	108 mm	25,01	1	TAH1995M-8*
10 mm	122 mm	25,82	1	TAH1995M-10*
12 mm	137 mm	27,12	1	TAH1995M-12*

Juego 7 llaves allen hex., métricas, en cuerda Kevlar



**TAHBE-9777B**

	€		
2,5,3,4,5,6,8,10 mm	40,95	1	TAHBE-9777B

Llave acodada para tornillos PH con alambre de acero



**TAH2047PR**

		€		
PH 1 & 2	100 mm	32,42	1	TAH2047PR-1-2

Llaves tipo "allen" fosfatadas métricas con anilla de acero inoxidable



**TAH1995Z**

		€		
1/2 in	145 mm	28,81	1	TAH1995Z-1/2*

Juego 7 llaves allen hex., pulgadas, con placa de inserción



**TAHBE-9787**

	€		
3/32, 1/8, 5/32, 3/16, 1/4, 5/16, 3/8 in	43,85	1	TAHBE-9787

**ALICATES CON ANILLO DE SEGURIDAD**

Alicate diagonal con anillo de seguridad



ergo®



**TAH2101G**

	€		
130 mm	59,08	1	TAH2101G-125
145 mm	54,28	1	TAH2101G-140
165 mm	62,89	1	TAH2101G-160
185 mm	64,57	1	TAH2101G-180
125 mm	59,08	1	TAH2101G-125C*
145 mm	62,11	1	TAH2101G-140C*
165 mm	62,89	1	TAH2101G-160C*
180 mm	64,57	1	TAH2101G-180C*

\* Hasta agotar existencias



Alicate cortante "Heavy Duty" con anilla de seguridad



ergo®



**TAHD21HDG**



L	€		
210 mm	65,94	1	TAHD21HDG-200
200 mm	65,94	1	TAHD21HDG-200C

Alicate boca semirredonda plana con anilla de seguridad



ergo®



**TAH2430G**



L	€		
160 mm	44,39	1	TAH2430G-160
200 mm	44,92	1	TAH2430G-200

Alicates de carraca para terminales aislados con lazo de alambre metálico fijo



**TAHCRW01**

L	€		
225 mm	155,56	1	TAHCRW01

Alicates universales con anilla de seguridad



ergo®



**TAH2628G**



L	€		
170 mm	58,45	1	TAH2628G-160
190 mm	60,24	1	TAH2628G-180
200 mm	76,89	1	TAH2628G-200*

Alicate boca semirredonda curvado con anilla de seguridad



ergo®



**TAH2427G**



L	€		
200 mm	46,11	1	TAH2427G-200

Alicates para arandelas interiores con mordazas rectas y anilla de acero inoxidable



**TAH2800**



L	€		
150 mm	46,15	1	TAH2800-150
180 mm	77,81	1	TAH2800-180

Alicate de apertura múltiple con anillo de seguridad



**TAH2970G**



L	€		
200 mm	61,25	1	TAH2970G-200*

Alicate pelacables para trabajos en altura



ergo®



**TAH2223G-150**



L	€		
167 mm	58,28	1	TAH2223G-150

Alicates para arandelas exteriores con mordazas rectas y anilla de acero inoxidable



**TAH2900**



L	€		
180 mm	78,46	1	TAH2900-180

Grip universal mordazas curvadas para trabajos en altura



**TAH2951**



	€		
235 m	63,91	1	TAH2951-250

Mordazas grip autoajustables con bocas curvas y placa metálica fijada



**TAH2953**



	€		
140 mm	59,12	1	TAH2953-140
300 mm	75,21	1	TAH2953-300

Mordaza grip boca recta con placa de inserción



**TAH2958**



	€		
200 mm	47,32	1	TAH2958-200
245 mm	51,13	1	TAH2958-250

Tenacilla articulada ERGO™ con anilla de seguridad



ergo



**TAH8224**



	€		
250 mm	75,73	1	TAH8224

Tenaza de encofrador con gran efecto palanca y Anillo de Seguridad



**TAH2339**



		€		
2.5 mm	250 mm	40,85	1	TAH2339-250

Alicate trenzador con anilla de seguridad



**TAH2855**



	€		
232 mm	211,20	1	TAH2855

## HERRAMIENTAS DE CORTE

Serruchos de poda plegables con mango bi-componente y muelle sellado Dyneema



**TAH396**



		€		
190 mm	7 1/2 in	60,12	1	TAH396-JT

Arco de sierra con cable de alambre



ergo



**TAH325**



	€		
300 mm	75,26	1	TAH325

Arco de sierra tradicional con cable de alambre



**TAH320**



	€		
500 mm	29,66	1	TAH320

\* Hasta agotar existencias



Arco de sierra con cable de alambre



**TAH317**



	€		
432 mm	40,46	1	TAH317

Arco de sierra de aluminio con cable de alambre



**TAH225**



	€		
310 mm	55,37	1	TAH225-PLUS

Mini sierras de mano con hoja bimetálica Sandflex® con cuerda de Kevlar



**TAH208**



	€		
330 mm	39,14	1	TAH208*

Lima plana con anilla de seguridad



ergo®



**TAH1-100**



		€		
265 mm	2	20,55	1	TAH1-100-06-2-4

Limas planas Ergo™ con anilla de acero inoxidable



ergo®



**TAH1-110**



		€		
200 mm	1	22,74	1	TAH1-110-08-1-2*

Lima basta 2 cantos planos y anilla de seguridad



ergo®



**TAH1-143**



		€		
415 mm	1	26,30	1	TAH1-143-12-1-2

Limas cuadradas Ergo™ con anilla de acero inoxidable



ergo®



**TAH1-160**



		€		
200 mm	1	20,39	1	TAH1-160-08-1-2*

Limas triangulares Ergo™ con anilla de acero inoxidable



ergo®



**TAH1-170**



		€		
200 mm	1	21,28	1	TAH1-170-08-1-2*

Lima media caña con anilla de seguridad



ergo®



**TAH1-210**



		€		
270 mm	2	23,70	1	TAH1-210-06-2-2
325 mm	1	25,14	1	TAH1-210-08-1-2*

Lima redonda con myril de seguridad



ergo®



**TAH1-230**



		€		
260 mm	2	12,95	1	TAH1-230-06-2-2
310 mm	1	26,62	1	TAH1-230-08-1-2*

Cizalla de Aviación de Corte Recto con Mayor Potencia por Acción de Palanca y Mango de Color Amarillo Codificado hasta 1,5 mm con Anillo de Seguridad



**TAHMA421**



	€		
250 mm	23,22	1	TAHMA421*



Tijera de electricista con asa de alambre



**TAHSB140G**

		€		
145 mm	43 mm	42,93	1	TAHSB140G

Cepillo de uso general



**TAH52-TAH782-U**

	€		
150 mm	25,42	1	TAH52
290 mm	24,32	1	TAH782-U

Maza boca de nylon con cable de acero



**TAH3625PW**

	€		
300 mm	54,48	1	TAH3625W-35

Navaja de electricista con cadena de Dyneema



**TAH2820EF**

		€		
195 mm	85 mm	28,39	1	TAH2820EF2

## MARTILLOS, PALANCAS Y CINCELES

Martillos de uña rectos ERGO™ con empuñadura de goma bimaterial y bucle de alambre



**TAH529S**

	€		
570 g	54,93	1	TAH529S-20-XL*

Mazas de punta de nylon con empuñadura de goma y lazo de alambre



**TAH3625S**

	€		
374 g	35,47	1	TAH3625S-28*

Multiherramientas plegables de aluminio 18 en 1 con lazo de alambre



**TAHMTT151**

	€		
150 mm	50,00	1	TAHMTT151

Martillo anti-rebote con anilla de seguridad



**TAH3625PU**

		€		
620 g	340 mm	64,41	1	TAH3625PU-50

Martillo de bola con cable de acero



**TAH479**

		€		
480 g	350 mm	64,82	1	TAH479-16
900 g	400 mm	70,96	1	TAH479-32

\* Hasta agotar existencias



Martillo tipo alemán DIN con cable de acero



**TAH481**



Weight	Length (L)	Price (€)	Quantity	Product Code
300 g	300 mm	51,36	1	TAH481-300

Martillos de bola con mango irrompible y lazo de alambre metálico fijo



**TAH490**



Weight	Length (L)	Price (€)	Quantity	Product Code
1100 g	340 mm	167,08	1	TAH490-1100*

Martillo anti chispa y anti magnético con argolla de aluminio bronce



**TAH487**



Weight	Length (L)	Price (€)	Quantity	Product Code
1000 g	110 mm	204,50	1	TAHNS502-1000-FB
4500 g	895 mm	612,43	1	TAH487-5200

Maceta con cable de acero



**TAH484**



Weight	Length (L)	Price (€)	Quantity	Product Code
1000 g	260 mm	64,11	1	TAH484-1000
1500 g	280 mm	62,07	1	TAH484-1500
2000 g	305 mm	65,10	1	TAH484-2000

Piqueta con anilla de alambre



**TAH486F**



Weight	Length (L)	Price (€)	Quantity	Product Code
700 g	330 mm	32,85	1	TAH486F-700

Barra desencofradora para trabajos en altura



**TAHWBB**



Length (L)	Price (€)	Quantity	Product Code
391 mm	32,70	1	TAHWBB400
595 mm	40,31	1	TAHWBB600
680 mm	42,93	1	TAHWBB700

Maza de seguridad con anilla



**TAH489**



Weight	Length (L)	Price (€)	Quantity	Product Code
1100 g	294 mm	211,09	1	TAH489-1100
1800 g	300 mm	226,10	1	TAH489-1800
2700 g	770 mm	235,45	1	TAH489-2700
3600 g	770 mm	259,68	1	TAH489-3600
4500 g	797 mm	362,70	1	TAH489-4500
5400 g	795 mm	306,49	1	TAH489-5400

Martillo de carpintero con varilla de acero tubular y alambre de acero



**TAH485**



Weight	Length (L)	Price (€)	Quantity	Product Code
600 g	318 mm	62,49	1	TAH485

Botador cilíndrico bi-material con placa de inserción



**TAH3734BM**



Length (L)	Bit Size	Price (€)	Quantity	Product Code
155 mm	2 mm	30,85	1	TAH3734BM-2
155 mm	3 mm	30,85	1	TAH3734BM-3
165 mm	4 mm	31,32	1	TAH3734BM-4
165 mm	5 mm	31,32	1	TAH3734BM-5
185 mm	6 mm	32,20	1	TAH3734BM-6
185 mm	8 mm	32,42	1	TAH3734BM-8
185 mm	10 mm	24,07	1	TAH3734BM-10

Granete bi-material con placa de inserción



**TAH3755BM**



		€		
165 mm	4 mm	17,04	1	TAH3755BM-4

Palanca polivalente con anilla de seguridad



**TAH2484**



	€		
305 mm	15,88	1	TAH2484-30

## MEDICIÓN Y TRAZADO

Cintas métricas con hoja revestida de nylon y carcasa abierta y con lazo de alambre de Dyneema



**TAHLTS**

		€		
30 m	13 mm	84,05	1	TAHLTS-30*

Cortafíos plano con anilla de seguridad



**TAH3640**



	€		
250 mm	34,91	1	TAH3640-250-C

Palanca especial 90° con argolla



**TAH3683**



	€		
400 mm	44,73	1	TAH3683

Reglas métricas de acero inoxidable con lazo de alambre de Dyneema



**TAHSR300**



	€		
300 mm	52,71	1	TAHSR300-MM

Cinzel octogonal con lazo de alambre metálico fijo



**TAH3739**



	€		
300 mm	35,17	1	TAH3739-300*

Palancas con cuerpo fosfatado y lazo de alambre metálico fijo



**TAH3681**



	€		
304 mm	73,63	1	TAH3681-11
406 mm	81,40	1	TAH3681-16
503 mm	100,06	1	TAH3681-20*

Nivel yamio con cuerda



**TAH466**



	€		
250 mm	45,75	1	TAH466-250

\* Hasta agotar existencias



Escuadra combinada equipado con dyneema para Trabajar en Altura



**TAHC300**

		€			
300 mm	125 mm	38,18	1	TAHC300*	

Escuadra equipada con dyneema para Trabajos en Altura



**TAH9048-250**

		€			
250 mm	165 mm	39,38	1	TAH9048-250*	

Escuadra equipada con dyneema para Trabajos en Altura



**TAH9045-B-250**

		€			
250 mm	170 mm	38,18	1	TAH9045-B-250	

Calibre con anilla de seguridad



**TAH1150**

	€			
7 x 75 x 235 mm	135,31	1	TAH1150-1/2H/P	

Punta de trazar con cuerda de alambre



**TAH1177**

	€			
30 g	25,02	1	TAH1177-SCRIBE	

Galgas profesionales con anilla de seguridad



**TAH1544**

	€			
105 mm	21,17	1	TAH1544	

## HERRAMIENTAS DINAMOMÉTRICAS

Llave mecánica de clic de par ajustable con escala marcada y cabezal y bucle de alambre intercambiables



**TAH7465-15**

		€			
9x12 mm	3-15 N·m	242,00	1	TAH7465-15*	

Llave dinamoétrica de disparo mecánico ajustable con visor de escala y cabeza fija de carraca con placa metálica



**TAH73R**

		€			
1/2"	20-100 N·m	455,63	1	TAH73R-100	
1/2"	40-200 N·m	470,82	1	TAH73R-200	
1/2"	60-300 N·m	488,18	1	TAH73R-300	

Llave dinamoétrica con cabeza intercambiable y alambre de seguridad



**TAH74W9**

		€			
20-100 N·m	9x12 mm	268,33	1	TAH74W9-100	



Cabeza de carraca reversible con dispositivo de bloqueo



**TAH7452-2**



		€		
9x12 mm	1/2"	124,27	1	TAH7452-2*

## HERRAMIENTAS DE SUJECCIÓN

Mordaza mango de plástico con grillete de seguridad para Trabajos en Altura



**TAH420SH-80-160**



		€		
160 mm	80 mm	46,16	1	TAH420SH-80-160*

Dedo flexible con cuerda de alambre



**TAH2509**



	€		
560 mm	96,93	1	TAH2509

Cabeza intercambiable carraca reversible con mecanismo de cierre pin de seguridad



**TAH7852-1**



		€		
14X18 mm	1/2"	99,20	1	TAH7852-1*

## OTRAS HERRAMIENTAS

Rasqueta de carbono con muelle de seguridad



**TAH2487**



	€		
205 mm	22,09	1	TAH2487

Extractor magnético con cuerda



ergo



**TAH2535F2**



		€		
13 mm	405 mm	52,72	1	TAH2535F2

Llave dinamométrica mecánica ajustable con cabeza de carraca fija y perno ocular de seguridad

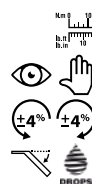

**TAH74R**



		€		
3/4"	700-1500 N·m	2.885,00	1	TAH74R-1500

Juego de punzones y ganchos con alambre Kevlar, 4 piezas



**TAH2633**



	€		
146 g	126,32	1	TAH2633/S4

Llave de filtro de cadena



**TAHBE64520**



		€		
520 mm	60-160 mm	99,22	1	TAHBE64520

\* Hasta agotar existencias



Lámpara frontal con cuerda



### TAHBFRL11



€



90 x 95 x 115 mm

79,94

1 TAHBFRL11

## GUANTES

Guantes de trabajo multiusos



### GL008



€



8

20,26

5 GL008-8

10

20,26

5 GL008-10

Bomba de grasa de acoplamiento rápido



### TAHBOD54



€



120 x 385 x 57 mm

52,95

1 TAHBOD5400

135 x 400 x 61 mm

73,07

1 TAHBOD5450

Guantes para herramienta de impacto



### GL010



€



8

25,73

5 GL010-8

10

25,73

5 GL010-10



## Herramientas aisladas



## DESTORNILLADORES AISLADOS

Destornillador ERGO™ aislado punta plana



ergo



### BE-8010S - BE-8065S

Tip	Length	Price (€)	Quantity	Model
2.5 mm	75 mm	7,88	5	BE-8010S
3.0 mm	100 mm	7,88	5	BE-8220S
3.5 mm	100 mm	8,22	5	BE-8230S
4.0 mm	100 mm	9,56	5	BE-8040S
5.5 mm	125 mm	11,41	5	BE-8050S
6.5 mm	150 mm	14,60	5	BE-8255S
8.0 mm	175 mm	16,12	5	BE-8065S
10 mm	200 mm	21,07	5	BE-8258S
12 mm	200 mm	24,49	5	BE-8259S

Destornillador aislado ERGO™ punta Phillips



ergo



### BE-8600S - BE-8640S

Tip	Length	Price (€)	Quantity	Model
PH 0	75 mm	8,21	5	BE-8600S
PH 1	80 mm	10,16	5	BE-8610S
PH1	80 mm	10,14	5	BE-8611S
PH 1	150 mm	11,58	5	BE-8612S
PH 2	100 mm	13,08	5	BE-8620S
PH 2	100 mm	15,87	5	BE-8621S
PH 2	175 mm	15,91	5	BE-8622S
PH 3	150 mm	16,78	5	BE-8630S
PH 4	200 mm	24,83	5	BE-8640S

Destornilladores ERGO™ aislados punta Pozidriv



ergo



### BE-8800S - BE-8840S

Tip	Length	Price (€)	Quantity	Model
PZ 0	75 mm	9,12	5	BE-8800S
PZ 1	80 mm	10,90	5	BE-8810S
PZ1	80 mm	10,90	5	BE-8811S
PZ 1	150 mm	12,91	5	BE-8812S
PZ 2	100 mm	13,60	5	BE-8820S
PZ 2	100 mm	14,10	5	BE-8821S
PZ 2	175 mm	15,97	5	BE-8822S
PZ 3	150 mm	20,47	5	BE-8830S
PZ 4	200 mm	23,49	5	BE-8840S

Destornillador ERGO™ aislado para tornillos TORX®



ergo



### BE-8910S - BE-8930S

Tip	Length	Price (€)	Quantity	Model
T 5	75 mm	8,24	5	BE-8905S
T 6	75 mm	8,24	5	BE-8906S
T 7	75 mm	8,24	5	BE-8907S
T 8	75 mm	8,24	5	BE-8908S
T 9	75 mm	8,24	5	BE-8909S
T 10	100 mm	8,51	5	BE-8910S
T 15	125 mm	8,57	5	BE-8915S
T 20	125 mm	8,72	5	BE-8920S
T 25	150 mm	9,04	5	BE-8925S
T 30	175 mm	11,68	5	BE-8930S

Destornillador ERGO™ aislado hexagonal



ergo



### BE-8725S - BE-8708S

Tip	Length	Price (€)	Quantity	Model
2.5 mm	100 mm	6,49	5	BE-8725S
3 mm	125 mm	6,77	5	BE-8703S
4 mm	150 mm	8,23	5	BE-8704S
5 mm	175 mm	9,31	5	BE-8705S
6 mm	150 mm	9,80	5	BE-8706S
8 mm	200 mm	13,18	5	BE-8708S

Destornillador ERGO™ aislados puntas combi



ergo



### BE-8510S - BE-8520S

Tip	Length	Price (€)	Quantity	Model
5.0/PH1	80 mm	10,09	5	BE-8510S
6.0/PH2	100 mm	13,75	5	BE-8520S

Destornilladores ERGO™ aislados puntas combi



ergo



### BE-8710S - BE-8720S

Tip	Length	Price (€)	Quantity	Model
5.0/PZ1	80 mm	10,99	5	BE-8710S
6.0/PZ2	100 mm	14,86	5	BE-8720S

Destornillador stecker aislado ERGO™



ergo



### BE-7855S - BE-7810S

Tip	Length	Price (€)	Quantity	Model
5.5 mm	125 mm	14,98	5	BE-7855S
6 mm	125 mm	16,45	5	BE-7806S
7 mm	125 mm	17,63	5	BE-7807S
8 mm	125 mm	19,47	5	BE-7808S
9 mm	125 mm	21,65	5	BE-7809S
10 mm	125 mm	23,95	5	BE-7810S



Juego 2 destornilladores ERGO™ aislados



ergo



**BE-9890S**

2 175 g 24,85 € 1 BE-9890S

Uso en cuadros eléctricos y terminales

BE-8710S, BE-8720S



Juego 5 destornilladores ERGO™ aislados



ergo



**BE-9881S**

5 45,51 € 1 BE-9881S

BE-8220S, BE-8040S, BE-8050S



BE-8611S, BE-8621S



Juego 5 destornilladores ERGO™ aislados



ergo



**BE-9882S**

5 46,95 € 1 BE-9882S

BE-8220S, BE-8050S, BE-8040S



BE-8811S, BE-8821S



Juego 4 destornilladores ERGO™ aislados



ergo

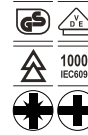

**BE-9885S**

5 48,47 € 1 BE-9885S

806-1-1



BE-8520S, BE-8510S



BE-8710S, BE-8720S



Juego 6 destornilladores ERGO™ aislados



ergo



**BE-9884S**

6 66,71 € 1 BE-9884S

BE-8220S, BE-8040S



BE-8710S, BE-8720S



BE-8810S, BE-8820S



Juego 7 destornilladores ERGO™ aislados



ergo

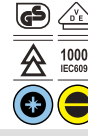

**BE-9888S**

7 66,95 € 1 BE-9888S

BE-8040S, BE-8050S, BE-8010S, BE-8220S

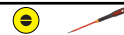

BE-8800S, BE-8821S, BE-8830S



Juego 6 destornilladores ERGO™ aislados y comprobador de tensión



ergo



**BE-9887S**

7 62,03 € 1 BE-9887S

806-1-1



BE-8010S, BE-8050S, BE-8230S, BE-8040S



BE-8611S, BE-8621S



Juego 6 destornilladores ERGO™ aislados y comprobador de tensión



ergo



**BE-9889S**

7 57,03 € 1 BE-9889S

BE-8010S, BE-8040S, BE-8050S, BE-8230S

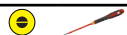

BE-8821S, BE-8811S

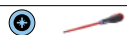

806-1-1



Juego destornilladores ERGO™ aislados, 14 piezas



ergo



**BE-9876S**

	€		
14	117,15	1	BE-9876S

BE-8010S, BE-8220S, BE-8230S, BE-8040S, BE-8050S



BE-8611S, BE-8621S



BE-8811S, BE-8821S

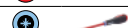

BE-8910S, BE-8915S, BE-8920S



BE-8710S, BE-8720S



Destornilladores ERGO™ aislados con aislamiento integrado



ergo



**BE-8220SL - BE-8255SL**

Bit	Length	€	Box	Fish
3.0 mm	100 mm	8,68	10	BE-8220SL
3.5 mm	100 mm	9,04	10	BE-8230SL
4.0 mm	100 mm	10,52	10	BE-8040SL
5.5 mm	125 mm	12,56	10	BE-8050SL
6.5 mm	150 mm	16,07	5	BE-8255SL

Destornilladores ERGO™ aislados PH con aislamiento integrado



ergo



**BE-8610SL - BE-8620SL**

Bit	Length	€	Box	Fish
PH 1	80 mm	11,17	10	BE-8610SL
PH 2	100 mm	14,41	10	BE-8620SL

Destornilladores ERGO™ aislados PZ con aislamiento integrado



ergo



**BE-8810SL - BE-8820SL**

Bit	Length	€	Box	Fish
PZ 1	80 mm	12,00	10	BE-8810SL
PZ 2	100 mm	14,95	10	BE-8820SL

Destornilladores ERGO™ aislados TORX con aislamiento integrado



ergo



**BE-8910SL - BE-8930SL**

Bit	Length	€	Box	Fish
T 10	100 mm	9,35	5	BE-8910SL
T 15	100 mm	9,43	5	BE-8915SL
T 20	100 mm	9,60	5	BE-8920SL
T 25	125 mm	9,95	5	BE-8925SL
T 30	150 mm	12,86	5	BE-8930SL

Destornilladores ERGO™ aislados punta COMBI PL/ PH con aislamiento integrado



ergo



**BE-8510SL - BE-8520SL**

Bit	Length	€	Box	Fish
5.0/PH1	80 mm	11,10	10	BE-8510SL
6.0/PH2	100 mm	15,13	10	BE-8520SL

Destornilladores ERGO™ aislados punta COMBI PL/PZ con aislamiento integrado



ergo



**BE-8710SL - BE-8720SL**

Bit	Length	€	Box	Fish
5.0/PZ1	80 mm	12,09	10	BE-8710SL
6.0/PZ2	100 mm	16,36	10	BE-8720SL

Juego 2 destornilladores ERGO™ aislados varilla integrada



ergo



**BE-9890SL**

Box	g	€	Box	Fish
2	175 g	27,36	1	BE-9890SL

BE-8710SL, BE-8720SL

Juego 2 destornilladores ERGO™ aislados varilla integrada



ergo



**BE-9891SL**

Box	g	€	Box	Fish
2	132 g	24,59	1	BE-9891SL

BE-8610SL, BE-8620SL

Juego 2 destornilladores ERGO™ aislados varilla integrada



ergo



**BE-9894SL**

X	g	€		
2	132 g	25,91	1	BE-9894SL

BE-8810SL, BE-8820SL

Juego 4 destornilladores ERGO™ aislados con varilla integrada



ergo



**BE-9880SL**

X	€		
4	44,14	1	BE-9880SL

BE-8910SL, BE-8915SL, BE-8920SL, BE-8925SL

Juego 5 destornilladores ERGO™ aislados con varilla integrada



ergo



**BE-9881SL**

X	€		
5	50,05	1	BE-9881SL

BE-8220SL, BE-8040SL, BE-8050SL

BE-8610SL, BE-8620SL

Juego 5 destornilladores ERGO™ aislados con varilla integrada



ergo

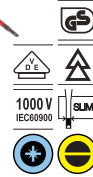

**BE-9882SL**

X	€		
5	51,64	1	BE-9882SL

BE-8220SL, BE-8040SL, BE-8050SL

BE-8810SL, BE-8820SL

Juego 5 destornilladores varilla fina



ergo

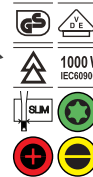

**BE-9871SL**

X	€		
5	55,23	1	BE-9871SL

BE-8220SL, BE-8040SL

BE-8910SL

BE-8610SL, BE-8620SL

Juego 5 destornilladores varilla fina



ergo



**BE-9872SL**

X	€		
5	56,41	1	BE-9872SL

BE-8220SL, BE-8040SL

BE-8910SL

BE-8810SL, BE-8820SL

Juego 12 destornilladores ERGO™ aislados



ergo



**BE-9878SL**

X	€		
12	111,13	1	BE-9878SL

BE-8010S

BE-8220SL, BE-8230SL, BE-8040SL, BE-8050SL

BE-8610SL, BE-8620SL

BE-8810SL, BE-8820SL

BE-8510SL, BE-8520SL

BE-8910SL

Destornillador Aislo Boca Recta BahcoFit



**B196**

Ø	L	€		
2.5 mm	75 mm	6,18	10	B196.025.075
3 mm	100 mm	6,08	10	B196.030.100
3.5 mm	100 mm	6,32	10	B196.035.100
4 mm	100 mm	7,37	10	B196.040.100
5.5 mm	125 mm	8,79	10	B196.055.125
6.5 mm	150 mm	11,25	10	B196.065.150
8 mm	175 mm	12,41	10	B196.080.175
10 mm	200 mm	16,23	10	B196.100.200
12 mm	200 mm	18,82	10	B196.120.200
2.5 mm	75 mm	6,93	1	SB196.025.075
3 mm	100 mm	6,83	1	SB196.030.100
3.5 mm	100 mm	7,11	1	SB196.035.100
4 mm	100 mm	8,12	1	SB196.040.100
5.5 mm	125 mm	9,55	1	SB196.055.125
6.5 mm	150 mm	11,99	1	SB196.065.150
8 mm	175 mm	13,17	1	SB196.080.175
10 mm	200 mm	16,98	1	SB196.100.200
12 mm	200 mm	19,62	1	SB196.120.200

SB: Presentación en clip



### Destornillador Aislo PH BahcoFit



#### B197PH

		€		
PH0	75 mm	6,31	10	B197.000.075
PH1	80 mm	7,80	10	B197.001.080
PH1	150 mm	8,82	10	B197.001.150
PH2	100 mm	10,07	10	B197.002.100
PH2	175 mm	12,11	10	B197.002.175
PH3	150 mm	12,90	10	B197.003.150
PH4	200 mm	19,10	10	B197.004.200
PH0	75 mm	7,09	1	SB197.000.075
PH1	80 mm	8,59	1	SB197.001.080
PH2	100 mm	10,84	1	SB197.002.100
PH3	150 mm	13,69	1	SB197.003.150
PH4	200 mm	19,87	1	SB197.004.200

SB: Presentación en clip

### Destornillador BahcoFit Aislo PZ



#### B142PZ

		€		
PZ0	75 mm	6,99	10	B142.000.075
PZ1	80 mm	8,39	10	B142.001.080
PZ1	150 mm	9,86	10	B142.001.150
PZ2	100 mm	10,45	10	B142.002.100
PZ2	175 mm	12,17	10	B142.002.175
PZ3	150 mm	15,75	10	B142.003.150
PZ0	75 mm	7,78	1	SB142.000.075
PZ1	80 mm	9,16	1	SB142.001.080
PZ2	100 mm	11,25	1	SB142.002.100
PZ3	150 mm	16,53	1	SB142.003.150

SB: Presentación en clip

### Destornilladores aislados ERGO™ punta TORX®



#### B150TORX

		€		
T10	100 mm	6,48	10	B150.010.100
T15	125 mm	6,52	10	B150.015.125
T20	125 mm	6,65	10	B150.020.125

**BAHCO**

		€		
T25	150 mm	6,88	10	B150.025.150
T10	100 mm	7,26	1	SB150.010.100
T15	125 mm	7,31	1	SB150.015.125
T20	125 mm	7,43	1	SB150.020.125
T25	150 mm	7,66	1	SB150.025.150

### Destornillador combi Phillips aislado



#### B148

		€		
5.0mm/PH1	80 mm	8,39	10	B148.001.080
6.0mm/PH2	100 mm	10,32	10	B148.002.100
5.0mm/PH1	80 mm	10,85	1	SB148.001.080
6.0mm/PH2	100 mm	11,51	1	SB148.002.100

### Destornillador BahcoFit Stecker Aislo



#### B199

		€		
5.5 mm	125 mm	11,61	5	B199.055.125
6 mm	125 mm	12,66	5	B199.060.125
7 mm	125 mm	13,57	5	B199.070.125
8 mm	125 mm	14,99	5	B199.080.125
9 mm	125 mm	16,64	5	B199.090.125
10 mm	125 mm	18,41	5	B199.100.125
11 mm	125 mm	20,15	5	B199.110.125
12 mm	125 mm	22,47	5	B199.120.125
13 mm	125 mm	24,94	5	B199.130.125
5.5 mm	125 mm	12,40	1	SB199.055.125
6 mm	125 mm	13,43	1	SB199.060.125
7 mm	125 mm	14,33	1	SB199.070.125
8 mm	125 mm	15,75	1	SB199.080.125
9 mm	125 mm	17,45	1	SB199.090.125
10 mm	125 mm	19,19	1	SB199.100.125
11 mm	125 mm	20,90	1	SB199.110.125
12 mm	125 mm	23,25	1	SB199.120.125
13 mm	125 mm	25,72	1	SB199.130.125

### Destornillador combi Pozidriv aislado



#### B149

		€		
5.0mm/PZ1	80 mm	8,71	10	B149.001.080
6.0mm/PZ2	100 mm	10,65	10	B149.002.100
5.0mm/PZ1	80 mm	11,05	1	SB149.001.080
6.0mm/PZ2	100 mm	11,77	1	SB149.002.100

### Juego 2 destornilladores BahcoFit aislados



#### B220.002

		€		
2	90 g	13,59	1	B220.002

B196.030.100

B197.001.080

### Juego 2 destornilladores BahcoFit punta COMBI PL/PZ



#### B220.012

		€		
2	182 g	22,73	1	B220.012*

B149.001.080, B149.002.100



Juego 5 destornilladores BahcoFit aislados PL/PH



**B220.005**

	€		
5	35,00	1	B220.005

B196.030.100, B196.040.100,  
B196.055.125



B197.001.080, B197.002.100



Juego 5 destornilladores BahcoFit aislados PL/PZ



**B220.015**

	€		
5	36,10	1	B220.015

B196.035.100, B196.040.100,  
B196.065.150



B142.001.080, B142.002.100



Juego 7 destornilladores BahcoFit aislados PL/PH



**B220.007**

	€		
7	51,52	1	B220.007

B196.030.100, B196.040.100,  
B196.055.125, B196.065.150



B197.000.075, B197.001.080,  
B197.002.100

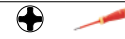

Juego 7 destornilladores BahcoFit aislados PL/PZ



**B220.017**

	€		
7	54,00	1	B220.017

B196.025.075, B196.040.100,  
B196.055.125, B196.065.150

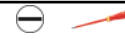

B142.000.075, B142.001.080,  
B142.002.100



Juego 7 destornilladores aislados BahcoFit PL/PH/TESTER



**B220.027**

	€		
7	47,71	1	B220.027

B196.030.100, B196.040.100,  
B196.055.125

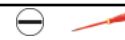

B197.000.075, B197.001.080,  
B197.002.100

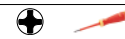

806-1-1



Destornillador Aislado boca Recta



**623**

Bit	Length	Price	Quantity	Code
3.0 mm	100 mm	6,08	10	623-3-100
3.5 mm	100 mm	6,61	10	623-3.5-100
4.0 mm	100 mm	6,90	10	623-4-100
5.5 mm	125 mm	9,58	10	623-5.5-125
6.5 mm	150 mm	11,41	10	623-6.5-150

Destornillador Boca Phillips aislado



**625PH**

Bit	Length	Price	Quantity	Code
PH 0	100 mm	4,24	10	625-0-100
PH 1	150 mm	7,90	10	625-1-150
PH 2	175 mm	11,00	10	625-2-175

Juego 6 destornilladores aislados Serie 600



**620-6**

	€		
6	51,03	1	620-6

623-4-100, 623-3-100, 623-5.5-125,  
623-6.5-150

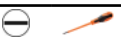

625-1-150, 625-2-175



\* Hasta agotar existencias



Juegostornillador a carraca con 6 varillas intercambiables 1000V



**808061**

		€		
7	85 x 85 x 218 mm	103,92	5	808061

Aislamiento integrado en varilla

808060		
8610SL-2P, 8620SL-2P		
8010SL-2P, 8050SL-2P, 8220SL-2P, 8040SL-2P		

Juego de destornillador a carraca 1000V con 6 varillas intercambiables



**808062**

		€		
7	85 x 85 x 215 mm	103,92	5	808062

808060		
8820SL-2P, 8810SL-2P		
8010SL-2P, 8050SL-2P, 8220SL-2P, 8040SL-2P		

Destornillador a carraca para varillas intercambiables 1000V



**808060**

		€		
36 mm	122 mm	41,16	1	808060

Carraca 48 dientes

Pack de 2 varillas intercambiables con aislamiento integrado



**8010SL-2P - 8050SL-2P**

		€		
0.4 mm	2.5 mm	13,43	1	8010SL-2P
0.5 mm	3.0 mm	13,43	1	8220SL-2P
0.8 mm	4.0 mm	14,11	1	8040SL-2P
1.0 mm	5.5 mm	14,11	1	8050SL-2P

Pack de 2 varillas intercambiables PH aisladas, 100mm



**8610SL-2P - 8620SL-2P**

	€		
1	14,11	1	8610SL-2P
2	14,11	1	8620SL-2P

Pack de 2 varillas intercambiables PZ aisladas, 100mm



**8810SL-2P - 8820SL-2P**

	€		
1	14,11	1	8810SL-2P
2	14,11	1	8820SL-2P

Varillas intercambiables aisladas con diámetro reducido



**8510SL-2P - 8520SL-2P**

	€		
5.0/PH1	20,92	1	8510SL-2P
6.0/PH2	20,92	1	8520SL-2P

Pack de 2 varillas intercambiables Combi (recta-PZ) aisladas, 100mm



**8710SL-2P - 8720SL-2P**

	€		
5.0/PZ1	20,92	1	8710SL-2P
6.0/PZ2	20,92	1	8720SL-2P

Pack de 2 varillas intercambiables TORX® aisladas, 100mm



**8910SL-2P - 8930SL-2P**

	€		
10	15,69	1	8910SL-2P
15	15,69	1	8915SL-2P
20	15,69	1	8920SL-2P
25	15,69	1	8925SL-2P
30	15,69	1	8930SL-2P

## ALICATES AISLADOS

Alicates corte diagonal con filos progresivos de seguridad mangos aislados



ergo



**2101S**

		€		
3.7 mm	2.0 mm	26,89	3	2101S-140
3.8 mm	2.5 mm	28,98	3	2101S-160
4.0 mm	2.7 mm	32,41	3	2101S-180

Alicate de corte diagonal aislado con filos progresivos



**2101S-200**



Cu	Fe+	€	Paquete	Forma
4.5 mm	3.0 mm	39,96	3	2101S-200

Alicate cortacables de seguridad



**2250V**



L	Paquete	Forma	€
170 mm	0-10 mm	2	112,39
230 mm	0-15 mm	2	130,96

Alicates universales de seguridad mangos aislados



ergo



**2628S**



Fe+	Plano	€	Paquete	Forma
2.0 mm	1.8 mm	30,70	3	2628 S-160
2.5 mm	2.0 mm	34,02	3	2628 S-180
3.0 mm	2.5 mm	37,20	3	2628 S-200

Alicate de seguridad corte lateral 1000V



**2171V**



Cu	L	€	Paquete	Forma
2.7 mm	160 mm	42,73	2	2171V-160
2.8 mm	180 mm	45,82	2	2171V-180
4.0 mm	200 mm	49,49	2	2171V-200

Cortavarillas de seguridad 1000V



**2820VBC**



L	€	Paquete	Forma
630 mm	234,14	1	2820VBC

Alicate ERGO™ universal cromado aislado. Filo de corte reforzado



ergo



**2630SC**



L	€	Paquete	Forma
180 mm	26,03	3	2630SC-180

Alicate corte frontal de seguridad



**527V**



L	€	Paquete	Forma
2 mm	160 mm	50,20	2
2.5 mm	200 mm	55,07	2

Alicate de corte lateral cromado plateado, 1000V aislado



**2674 NVDE**



Cu	Fe+	€	Paquete	Forma
3.7 mm	2.0 mm	88,74	1	2674 NVDE

Alicate universal de seguridad



**2678V**



Cu	L	€	Paquete	Forma
2.7 mm	160 mm	43,03	2	2678V-160
3.0 mm	180 mm	46,92	2	2678V-180
4.0 mm	200 mm	50,46	2	2678V-200



Alicate boca semirredonda de seguridad mangos aislados



ergo®



**2430S**

Gu	Pe	€		
2.5 mm	1.8 mm	27,92	3	2430S-140
3.0 mm	1.8 mm	28,59	3	2430 S-160
3.0 mm	1.8 mm	31,34	3	2430 S-200



Alicates ERGO™ de boca redonda mangos aislados



ergo®



**2521S**

L	€		
140 mm	33,31	3	2521S-140
160 mm	35,05	3	2521S-160



Alicate boca plana de seguridad



**2421V**

L	€		
160 mm	39,86	2	2421V-160



Alicate boca semirredonda aislado con bocas curvadas 45°



ergo®



**2427S**

Gu	Pe	€		
3.0 mm	1.8 mm	34,73	3	2427S-160
3.0 mm	1.8 mm	35,00	3	2427 S-200



Alicate boca semirredonda de seguridad mangos aislados



**2430V**

Gu	L	€		
3.0 mm	160 mm	47,51	2	2430V-160
3.0 mm	200 mm	47,84	2	2430V-200



Alicate boca redonda de seguridad 1000V



**2521V**

L	€		
160 mm	40,50	2	2521V-160



Alicates ERGO™ de boca plana y cabeza larga, aislados



ergo®



**2421S**

L	€		
140 mm	33,58	3	2421S-140
160 mm	33,58	3	2421S-160
180 mm	44,62	3	2421S-180



Alicate boca semirredonda 60° de seguridad



**2427V**

Gu	L	€		
3.0 mm	200 mm	53,57	2	2427V-200



Pelacables aislado 1000V



ergo®



**2223S**

L	€		
165 mm	34,02	3	2223 S-150





Pelacables de seguridad



**2223V**

L	€	Paquetes	Modelos
160 mm	53,57	2	2223V-160



Llave ajustable moleta lateral de seguridad



**8070VL-8073VL**

L	€	Paquetes	Modelos
160mm/6"	49,22	1	8070VL
210mm/8"	57,44	1	8071VL
260mm/10"	67,72	1	8072VL
310mm/12"	88,88	1	8073VL



€	Paquetes	Modelos
47,92	2	6MV-27
53,43	2	6MV-30
54,73	2	6MV-32

Tenacilla articulada ajustable aislada para trabajos en equipos de hasta 1000V



**7224S**

L	€	Paquetes	Modelos
16 250 mm	40,52	4	7224S



Llave ajustable de seguridad, moleta lateral



**8071VLT - 8073VLT**

L	€	Paquetes	Modelos
205mm/8"	162,40	1	8071VLT
255mm/10"	181,59	1	8072VLT
305mm/12"	197,84	1	8073VLT



Llave estrella acodada de una boca 1000V



**2MV**

€	Paquetes	Modelos
29,56	5	2MV-6
29,56	5	2MV-7
31,13	5	2MV-8
31,74	5	2MV-9
31,65	5	2MV-10
31,94	5	2MV-11
31,94	5	2MV-12
34,26	5	2MV-13
35,22	5	2MV-14
36,52	5	2MV-15
37,03	5	2MV-16
38,16	3	2MV-17
38,84	3	2MV-18
40,14	3	2MV-19
42,24	3	2MV-21
42,56	3	2MV-22
45,34	3	2MV-23
46,80	3	2MV-24



ISO 8976, IEC 60900

**LLAVES AISLADAS**

Llave ajustable de seguridad 1000 V



**8070V - 8074V**

L	€	Paquetes	Modelos
165mm/6"	40,31	2	8070V
205mm/8"	49,02	2	8071V
260mm/10"	54,64	2	8072V
310mm/12"	72,49	2	8073V
390mm/15"	117,21	2	8074V



Llave fija de una boca 1000V



**6MV**

€	Paquetes	Modelos
24,81	5	6MV-6
25,14	5	6MV-7
22,85	5	6MV-8
23,91	5	6MV-9
24,18	5	6MV-10
24,34	5	6MV-11
25,55	5	6MV-12
26,85	5	6MV-13
26,85	5	6MV-14
26,74	5	6MV-15
28,17	5	6MV-16
28,70	3	6MV-17
29,36	3	6MV-18
30,46	3	6MV-19
31,94	3	6MV-20
34,43	3	6MV-21
35,93	3	6MV-22
40,04	3	6MV-23
41,56	3	6MV-24



Llave de tubo con mango en "T" 1000V



**28MV**

€	Paquetes	Modelos
37,61	2	28MV-8
37,61	2	28MV-9
37,96	2	28MV-10
38,44	2	28MV-11
38,78	2	28MV-12
39,11	2	28MV-13
43,82	2	28MV-14
44,32	2	28MV-15
45,51	2	28MV-16
46,15	2	28MV-17
47,45	2	28MV-18
47,45	2	28MV-19
47,30	2	28MV-20
47,63	2	28MV-21
49,90	2	28MV-22



Llave hexagonal macho acodada 1000V



**1999MV**



	€		
3 mm	15,86	5	1999MV-3
4 mm	16,43	5	1999MV-4
5 mm	16,26	5	1999MV-5
6 mm	16,58	5	1999MV-6
7 mm	17,37	5	1999MV-7
8 mm	18,34	5	1999MV-8
9 mm	18,97	5	1999MV-9
10 mm	20,57	3	1999MV-10
12 mm	23,12	3	1999MV-12

Llave de carraca de 1/2" de seguridad 1000V



**8150-1/2V**



L	€		
270 mm	201,01	1	8150-1/2V

Mango en "T" de 1/2" de seguridad 1000V



**8154-1/2V**



L		€		
200 mm	190 mm	64,11	1	8154-1/2V

Alargadera de 1/2" de seguridad, 1000V



**7800DMV**



	€		
8 mm	24,70	10	7800DMV-8
10 mm	25,42	10	7800DMV-10
11 mm	25,42	10	7800DMV-11
12 mm	25,42	10	7800DMV-12
13 mm	25,42	10	7800DMV-13
14 mm	25,28	10	7800DMV-14
15 mm	25,28	10	7800DMV-15
16 mm	25,99	10	7800DMV-16
17 mm	26,15	10	7800DMV-17
18 mm	25,75	10	7800DMV-18
19 mm	26,49	10	7800DMV-19
20 mm	26,88	10	7800DMV-20
21 mm	26,48	10	7800DMV-21
22 mm	26,65	10	7800DMV-22
24 mm	28,06	5	7800DMV-24
27 mm	28,92	5	7800DMV-27
30 mm	31,50	5	7800DMV-30
32 mm	32,68	5	7800DMV-32

**8160-1/2V - 8162-1/2V**



L	€		
125 mm	48,01	1	8160-1/2V
250 mm	51,41	1	8162-1/2V



**TIJERAS Y CUCHILLOS AISLADOS**

Tijera para electricista aislada



**SC127V**



	L	€		
50 mm	130 mm	24,50	5	SC127V

Tijera para electricista de seguridad



**SC150NGV**



	L	€		
38 mm	150 mm	37,81	5	SC150NGV

Cuchillo recto aislado



**2820VP**



	L	€		
50 mm	180 mm	30,98	2	2820VP

Cuchillo curvo de seguridad



**2820VPC**



		€		
50 mm	180 mm	33,61	2	2820VPC

## EQUIPOS DE PROTECCIÓN

Empuñadura de seguridad



**2820VFP**



	g	€		
458 g		125,86	1	2820VFP

Guantes de algodón



**2820VGCOT**

	g	€		
50 g		5,04	1	2820VGCOT

Cuchillo aislado con capuchon protector de plástico



**2820VDE**



		€		
55.5 mm	180 mm	25,06	10	2820VDE

Alfombra aislada 1000V



**2820VM**



		€		
1000 mm	1000 mm	234,74	1	2820VM

## JUEGOS DE HERRAMIENTAS AISLADAS

Juego de alicates universales aislados ERGO™ (3 piezas)



ergo®



**9897S/3**



		€		
3	50 x 180 x 400 mm	95,58	1	9897S/3

<b>2628 S-180</b>			
<b>2101S-160</b>			
<b>2430 S-200</b>			

## PINZAS AISLADAS

Pinzas de seguridad



**2820VTEE**



	€		
145 mm	33,26	1	2820VTEE

Guantes aislados



**2820VG**



	V	€		
500 V		70,58	1	2820VG05
1000 V		84,88	1	2820VG10



Juego de 8 llaves fijas, 1000V



6MV/



	€		
8 mm	217,17	1	6MV/8T

6MV-10, 6MV-11, 6MV-12, 6MV-13,  
6MV-14, 6MV-17, 6MV-18, 6MV-19



Juego de 10 llaves fijas, 1000V



6MV/10T 1



	€		
10 mm	291,12	1	6MV/10T

6MV-10, 6MV-11, 6MV-12, 6MV-13,  
6MV-14, 6MV-16, 6MV-17, 6MV-18,  
6MV-19, 6MV-22



Juego de 11 herramientas aisladas



7811DMV



		€		
11	270 x 79 x 350 mm	550,06	1	7811DMV

7800DMV-13, 7800DMV-10, 7800DMV-11,  
7800DMV-22, 7800DMV-17,  
7800DMV-19, 7800DMV-20



8150-1/2V



8154-1/2V



8160-1/2V



BE-8050S



Juego de 10 herramientas para electricista



3045/1VDE



		€		
10	225 x 70 x 300 mm	456,82	1	3045/1VDE

BE-8010S, BE-8040S, BE-8050S, BE-8220S,  
BE-8230S, BE-8255S

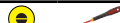

BE-8620S



2171V-160



2430V-160



2678V-180



Juego de 10 herramientas aisladas



3045V-1



		€		
10	60 x 240 x 330 mm	312,74	1	3045V-1

2171V-160



2678V-180



2223V-160



BE-8220S, BE-8040S, BE-8050S

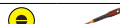

BE-8610S, BE-8620S



2820VP



SC127V



Maleta cuero portaherramientas para electricista 1000V



3045V-2



		€		
19	200 x 285 x 445 mm	782,42	1	3045V-2

Incluye set 19 herramientas: TS200

2171V-160



2678V-180



2430V-160



2223V-160



BE-8220S, BE-8040S, BE-8050S,  
BE-8255S



BE-8610S, BE-8620S



6MV-10, 6MV-11, 6MV-13, 6MV-12,  
6MV-14, 6MV-17, 6MV-19



2820VP

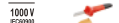

SC150NGV





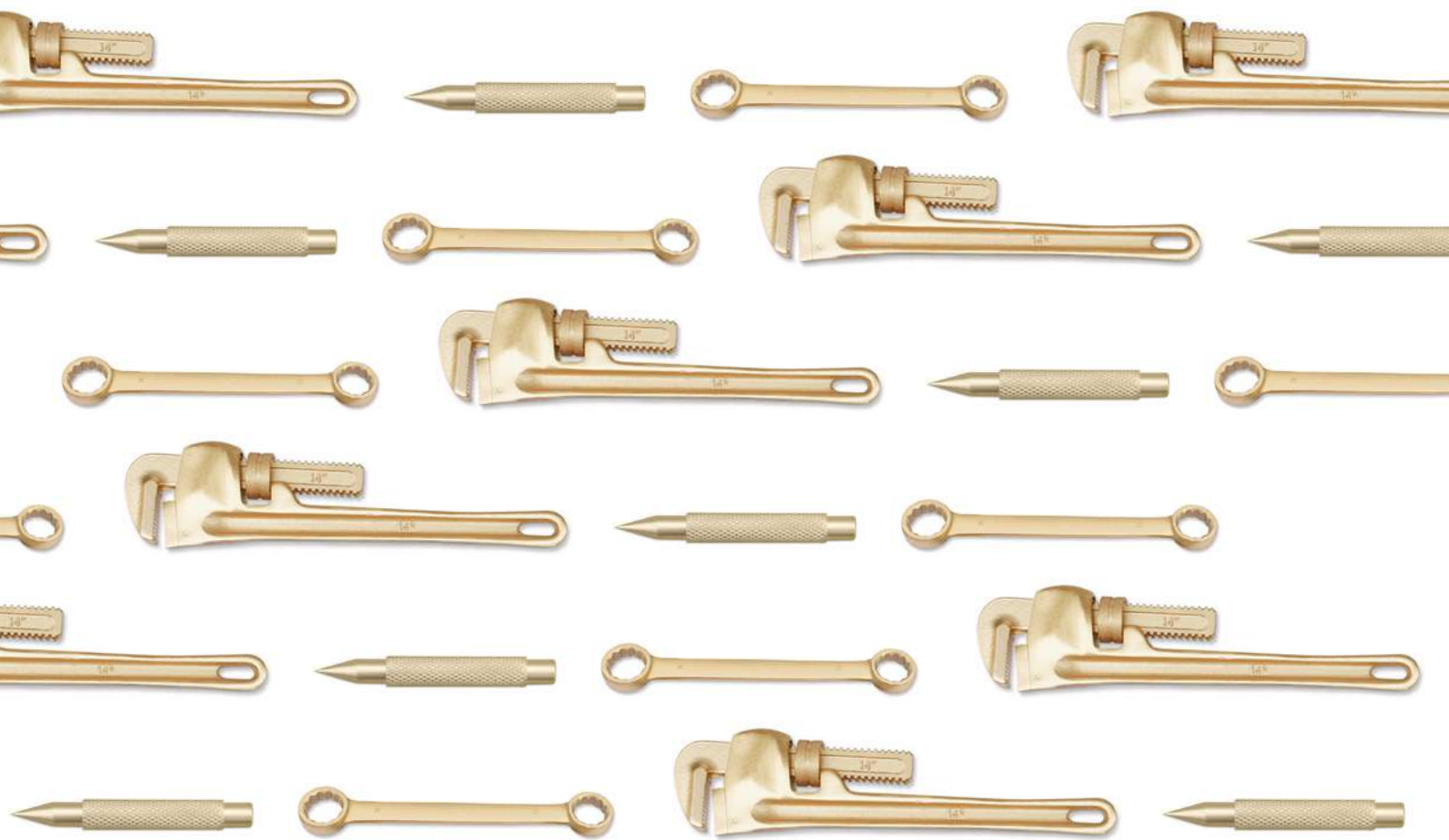

## Herramientas antichispa



## LLAVES ANTICHISPA

Llave ajustable anti chispa, AL-BR



### NS001

Icon	L	€	Icon	Icon
18 mm	150mm/6"	107,67	5	NS001-150
24 mm	200mm/8"	123,25	5	NS001-200
30 mm	250mm/10"	165,74	5	NS001-250
36 mm	300mm/12"	211,09	5	NS001-300
46 mm	375mm/15"	325,82	5	NS001-375
55 mm	450mm/18"	453,33	3	NS001-450
65 mm	600mm/24"	736,67	1	NS001-600
75 mm	900mm/36"	1.656,29	1	NS001-900

Llave ajustable anti chispa, CU-BE



### NSB001

Icon	L	€	Icon	Icon
18 mm	150mm/6"	153,00	5	NSB001-150
24 mm	200mm/8"	191,24	5	NSB001-200
30 mm	250mm/10"	255,01	5	NSB001-250
36 mm	300mm/12"	283,33	5	NSB001-300
48 mm	375mm/15"	429,97	5	NSB001-375
55 mm	450mm/18"	584,03	3	NSB001-450
65 mm	600mm/24"	1.078,29	3	NSB001-600
75 mm	900mm/36"	2.413,62	1	NSB001-900

BAM/ZBF/003/21

Llave combinada anti chispa, AL-BR



### NS002

Icon	€	Icon	Icon
6 mm	36,02	5	NS002-6
7 mm	40,83	5	NS002-7
8 mm	40,83	5	NS002-8
9 mm	42,19	5	NS002-9
10 mm	36,69	10	NS002-10
11 mm	45,99	5	NS002-11
12 mm	45,99	5	NS002-12

Icon	€	Icon	Icon
13 mm	45,99	10	NS002-13
14 mm	48,71	5	NS002-14
15 mm	51,42	5	NS002-15
16 mm	54,13	5	NS002-16
17 mm	67,64	10	NS002-17
18 mm	70,35	5	NS002-18
19 mm	73,05	10	NS002-19
20 mm	75,77	5	NS002-20
21 mm	78,47	5	NS002-21
22 mm	81,16	10	NS002-22
23 mm	86,59	5	NS002-23
24 mm	92,01	10	NS002-24
25 mm	94,70	5	NS002-25
26 mm	108,24	5	NS002-26
27 mm	108,24	5	NS002-27
28 mm	117,02	5	NS002-28
29 mm	119,74	10	NS002-29
30 mm	128,51	10	NS002-30
31 mm	135,30	5	NS002-31
32 mm	142,05	5	NS002-32
33 mm	154,97	5	NS002-33
34 mm	158,81	5	NS002-34
35 mm	162,35	5	NS002-35
36 mm	169,12	5	NS002-36
38 mm	175,87	5	NS002-38
40 mm	189,41	5	NS002-40
41 mm	216,45	5	NS002-41
42 mm	230,00	5	NS002-42
46 mm	243,53	5	NS002-46
50 mm	311,16	5	NS002-50
52 mm	313,89	5	NS002-52
55 mm	318,33	5	NS002-55
60 mm	353,79	1	NS002-60
65 mm	449,05	1	NS002-65
70 mm	517,10	1	NS002-70*
75 mm	598,73	1	NS002-75
80 mm	707,59	1	NS002-80*

BAM/ZBF/002/21

Llave combinada anti chispa, CU-BE



### NSB002

Icon	€	Icon	Icon
6 mm	62,43	5	NSB002-6
7 mm	62,43	5	NSB002-7
8 mm	62,43	5	NSB002-8
9 mm	50,47	5	NSB002-9
10 mm	50,06	5	NSB002-10
11 mm	54,13	5	NSB002-11
12 mm	59,53	5	NSB002-12
13 mm	62,23	5	NSB002-13
17 mm	87,93	5	NSB002-17
14 mm	64,94	5	NSB002-14
15 mm	74,28	5	NSB002-15
16 mm	77,13	5	NSB002-16
18 mm	92,01	5	NSB002-18
19 mm	94,70	5	NSB002-19
20 mm	97,41	5	NSB002-20
21 mm	105,54	5	NSB002-21
22 mm	108,24	5	NSB002-22
25 mm	135,30	5	NSB002-25
23 mm	113,64	5	NSB002-23
26 mm	141,51	5	NSB002-26
24 mm	128,51	5	NSB002-24
27 mm	145,07	5	NSB002-27
28 mm	178,97	5	NSB002-28

Icon	€	Icon	Icon
29 mm	183,14	5	NSB002-29
30 mm	197,71	5	NSB002-30
31 mm	239,34	1	NSB002-31
32 mm	249,73	10	NSB002-32
33 mm	251,35	1	NSB002-33
34 mm	257,11	1	NSB002-34
35 mm	260,15	1	NSB002-35
36 mm	280,95	5	NSB002-36
38 mm	301,77	1	NSB002-38
40 mm	330,90	1	NSB002-40
41 mm	355,87	5	NSB002-41
42 mm	374,61	1	NSB002-42
46 mm	414,15	1	NSB002-46
50 mm	457,85	1	NSB002-50
52 mm	474,52	1	NSB002-52*
55 mm	499,47	1	NSB002-55*
60 mm	541,09	1	NSB002-60*
65 mm	686,78	1	NSB002-65*
70 mm	790,83	1	NSB002-70*
75 mm	915,72	1	NSB002-75*
80 mm	1.082,20	1	NSB002-80*

BAM/ZBF/003/21

Llaves combinadas en pulgadas antichispa de Aluminio Bronce



### NS003



Icon	€	Icon	Icon
1/4 in	33,46	1	NS003-8*
11/32 in	38,64	1	NS003-11*
3/8 in	39,79	1	NS003-12*
7/16 in	41,82	1	NS003-14*
1/2 in	46,93	1	NS003-16
9/16 in	51,01	1	NS003-18
5/8 in	55,72	1	NS003-20*
3/4 in	70,79	1	NS003-24*
7/8 in	79,06	1	NS003-28
15/16 in	98,29	1	NS003-30

Llaves combinadas en pulgadas anti-chispa de cobre berilio



### NSB003

Icon	€	Icon	Icon
1/4 in	71,97	1	NSB003-8*
5/16 in	81,03	1	NSB003-10
11/32 in	92,15	1	NSB003-11
3/8 in	101,35	5	NSB003-12
13/32 in	104,76	1	NSB003-13*
7/16 in	106,88	1	NSB003-14



	€		
1/2 in	120,13	5	NSB003-16
9/16 in	128,63	1	NSB003-18
19/32 in	132,67	1	NSB003-19*
5/8 in	139,04	1	NSB003-20
11/16 in	150,23	5	NSB003-22
3/4 in	153,71	5	NSB003-24
25/32 in	164,18	1	NSB003-25*
13/16 in	182,38	1	NSB003-26*
7/8 in	188,56	5	NSB003-28*
15/16 in	220,71	1	NSB003-30
31/32 in	241,55	1	NSB003-31*
1 in	247,21	1	NSB003-32
1.1/16 in	315,70	1	NSB003-34
1.1/8 in	374,28	1	NSB003-36
1.3/16 in	382,78	1	NSB003-38*
1.1/4 in	423,29	1	NSB003-40
1.5/16 in	494,54	1	NSB003-42
1.3/8 in	514,47	5	NSB003-44*
1.7/16 in	535,05	1	NSB003-46*
1.1/2 in	585,29	1	NSB003-48*
1.9/16 in	618,72	1	NSB003-50*
1.5/8 in	629,39	1	NSB003-52
1.11/16 in	707,28	1	NSB003-54*
1.3/4 in	715,96	1	NSB003-56*
1.13/16 in	742,52	1	NSB003-58*
1.7/8 in	849,99	1	NSB003-60*
1.15/16 in	854,16	1	NSB003-62*
2 in	868,25	5	NSB003-64*
2.1/8 in	926,19	1	NSB003-68*
2.1/4 in	1.014,94	1	NSB003-72*
2.1/2 in	1.097,32	1	NSB003-80*
2.5/8 in	1.174,29	1	NSB003-84
2.3/4 in	1.204,90	1	NSB003-88



BAM/ZBF/003/21

### Llave Fija anti chispa, AL-BR



### NS006

	€		
6x7 mm	18,52	1	NS006-0607
6x8 mm	18,86	1	NS006-0608
7x8 mm	18,53	1	NS006-0708
7x9 mm	18,84	1	NS006-0709
8x9 mm	18,53	1	NS006-0809
8x10 mm	19,61	1	NS006-0810
9x10 mm	19,95	1	NS006-0910*
9x11 mm	23,98	1	NS006-0911
10x11 mm	23,27	1	NS006-1011
10x12 mm	26,15	1	NS006-1012
10x13 mm	26,59	1	NS006-1013
10x14 mm	26,81	1	NS006-1014*
11x13 mm	30,52	1	NS006-1113
11x14 mm	31,02	1	NS006-1114
12x13 mm	29,09	1	NS006-1213
12x14 mm	39,73	1	NS006-1214
13x15 mm	43,59	1	NS006-1315
14x15 mm	34,91	1	NS006-1415
14x16 mm	43,59	1	NS006-1416
14x17 mm	34,91	1	NS006-1417



	€		
16x17 mm	37,80	1	NS006-1617
16x18 mm	37,80	1	NS006-1618
17x19 mm	37,80	1	NS006-1719
17x22 mm	43,63	1	NS006-1722*
18x19 mm	43,63	1	NS006-1819
18x20 mm	46,35	1	NS006-1820*
19x20 mm	46,54	1	NS006-1920
19x22 mm	52,35	1	NS006-1922
19x24 mm	52,35	1	NS006-1924
20x22 mm	52,35	1	NS006-2022
21x22 mm	52,79	1	NS006-2122
21x23 mm	55,25	1	NS006-2123
22x23 mm	58,17	1	NS006-2223
22x24 mm	58,65	1	NS006-2224
22x27 mm	65,44	1	NS006-2227
23x26 mm	66,57	1	NS006-2326
24x25 mm	71,48	1	NS006-2425
24x26 mm	72,72	1	NS006-2426
24x27 mm	51,42	1	NS006-2427
24x30 mm	58,13	1	NS006-2430
25x28 mm	54,13	1	NS006-2528
26x29 mm	55,53	1	NS006-2629*
27x29 mm	62,23	1	NS006-2729
27x30 mm	77,61	1	NS006-2730
27x32 mm	86,93	1	NS006-2732
28x30 mm	86,93	1	NS006-2830
30x31 mm	90,03	1	NS006-3031
30x32 mm	109,06	1	NS006-3032
30x34 mm	95,61	1	NS006-3034*
30x36 mm	95,61	1	NS006-3036
32x34 mm	95,61	1	NS006-3234
32x35 mm	95,61	1	NS006-3235
32x36 mm	138,13	1	NS006-3236
33x35 mm	145,36	1	NS006-3335
34x36 mm	145,36	1	NS006-3436
35x36 mm	145,36	1	NS006-3536
36x38 mm	212,39	1	NS006-3638
36x41 mm	212,39	1	NS006-3641
38x42 mm	235,98	1	NS006-3642
41x46 mm	218,12	1	NS006-4146
46x50 mm	306,79	1	NS006-4650
50x52 mm	311,50	1	NS006-5052*
50x55 mm	316,22	1	NS006-5055
50x60 mm	320,94	1	NS006-5060*
50x62 mm	436,24	1	NS006-5062*
55x60 mm	465,31	1	NS006-5560
60x65 mm	567,11	1	NS006-6065
65x70 mm	581,65	1	NS006-6570*



BAM/ZBF/002/21

### Llave fija anti chispa, CU-BE



### NSB006

	€		
6X7 mm	23,42	1	NSB006-0607
6X8 mm	23,85	1	NSB006-0608*
7X8 mm	26,53	1	NSB006-0708

	€		
7X9 mm	26,98	1	NSB006-0709*
8X9 mm	26,55	1	NSB006-0809
8X10 mm	28,10	1	NSB006-0810
9X10 mm	28,56	1	NSB006-0910
9X11 mm	34,34	1	NSB006-0911
10X11 mm	34,91	1	NSB006-1011
10X12 mm	37,80	1	NSB006-1012
10X13 mm	38,44	1	NSB006-1013
10X14 mm	40,72	1	NSB006-1014
11X13 mm	46,35	1	NSB006-1113
11X14 mm	47,12	1	NSB006-1114*
12X13 mm	46,54	1	NSB006-1213
12X14 mm	46,92	1	NSB006-1214
13X15 mm	51,48	1	NSB006-1315
14X15 mm	52,35	1	NSB006-1415
14X16 mm	61,14	1	NSB006-1416
14X17 mm	62,68	1	NSB006-1417
16X17 mm	61,08	1	NSB006-1617
16X18 mm	61,56	1	NSB006-1618
17X19 mm	70,00	1	NSB006-1719
17X22 mm	77,79	1	NSB006-1722*
18X19 mm	79,08	1	NSB006-1819
18X20 mm	79,73	1	NSB006-1820*
19X20 mm	81,03	1	NSB006-1920
19X22 mm	82,33	1	NSB006-1922
19X24 mm	90,91	1	NSB006-1924*
20X22 mm	90,16	1	NSB006-2022
21X22 mm	90,91	1	NSB006-2122
21X23 mm	91,64	1	NSB006-2123
22X23 mm	92,37	1	NSB006-2223
22X24 mm	93,11	1	NSB006-2224
22X27 mm	98,37	1	NSB006-2227*
23X26 mm	105,68	1	NSB006-2326
24X25 mm	107,44	1	NSB006-2425
24X26 mm	109,19	1	NSB006-2426
24X27 mm	119,44	1	NSB006-2427
24x30 mm	120,94	1	NSB006-2430
25x28 mm	122,95	1	NSB006-2528
26x29 mm	132,71	1	NSB006-2629*
27-29 mm	132,71	1	NSB006-2729
27x30 mm	132,71	1	NSB006-2730
27x32 mm	148,62	1	NSB006-2732
28x30 mm	148,62	1	NSB006-2830
30x31 mm	153,93	1	NSB006-3031
30x32 mm	159,96	1	NSB006-3032
30x34 mm	169,89	1	NSB006-3034*
30x36 mm	169,89	1	NSB006-3036
32x34 mm	169,89	1	NSB006-3234
32x35 mm	169,89	1	NSB006-3235
32x36 mm	169,89	1	NSB006-3236
33x35 mm	169,89	1	NSB006-3335*
34x36 mm	169,89	1	NSB006-3436
35x36 mm	169,89	1	NSB006-3536*
36x38 mm	248,20	1	NSB006-3638
36x41 mm	248,20	1	NSB006-3641
38x42 mm	275,78	1	NSB006-3642*
41x46 mm	319,91	1	NSB006-4146
46x50 mm	392,61	1	NSB006-4650
50x52 mm	398,66	1	NSB006-5052*
50X55 mm	404,69	1	NSB006-5055*
50X60 mm	410,72	1	NSB006-5060*
50X62 mm	416,77	1	NSB006-5062*
55X60 mm	531,53	1	NSB006-5560*
60X65 mm	555,70	1	NSB006-6065*
65X70 mm	591,93	1	NSB006-6570*

BAM/ZBF/003/21

\* Hasta agotar existencias



Llave estrella plana anti chispa, AL-BR



**NS010**

	€		
6x7 mm	36,51	1	NS010-0607*
7x9 mm	36,51	1	NS010-0709*
8x9 mm	38,75	1	NS010-0809
9x11 mm	40,99	1	NS010-0911*
10x11 mm	40,99	1	NS010-1011
10x12 mm	42,58	1	NS010-1012
12x14 mm	44,20	1	NS010-1214
13x15 mm	52,52	1	NS010-1315
14x17 mm	52,52	1	NS010-1417
16x18 mm	69,80	1	NS010-1618
17x19 mm	76,85	1	NS010-1719
17x22 mm	84,53	1	NS010-1722*
18x19 mm	76,85	1	NS010-1819
19x21 mm	93,49	1	NS010-1921
19x22 mm	95,72	1	NS010-1922
20x22 mm	97,97	1	NS010-2022
21x23 mm	105,67	1	NS010-2123*
22x24 mm	115,27	1	NS010-2224
24x27 mm	135,75	1	NS010-2427
25x28 mm	151,78	1	NS010-2528*
26x28 mm	154,89	1	NS010-2628
27x30 mm	158,02	1	NS010-2730
27x32 mm	174,34	1	NS010-2732
30x32 mm	185,07	1	NS010-3032
30x36 mm	231,32	1	NS010-3036
32x36 mm	277,60	1	NS010-3236
36x41 mm	416,39	1	NS010-3641
41x46 mm	453,99	1	NS010-4146*
46x50 mm	482,36	1	NS010-4650*

BAM/ZBF/002/21

Llave estrella plana anti chispa, CU-BE



**NSB010**

	€		
6X7 mm	48,84	1	NSB010-0607
7X9 mm	48,84	1	NSB010-0709*
8X9 mm	47,84	1	NSB010-0809
9X11 mm	51,56	1	NSB010-0911*

€

10X11 mm	51,56	1	NSB010-1011
10X12 mm	57,14	1	NSB010-1012*
12X14 mm	62,76	1	NSB010-1214
13X15 mm	74,92	1	NSB010-1315*
14X17 mm	74,92	1	NSB010-1417*
16X18 mm	99,89	1	NSB010-1618
17X19 mm	110,16	1	NSB010-1719
17X22 mm	118,77	1	NSB010-1722*
18X19 mm	110,16	1	NSB010-1819*
19X21 mm	120,87	1	NSB010-1921*
19X22 mm	121,80	1	NSB010-1922
20X22 mm	122,71	1	NSB010-2022
21X23 mm	131,68	1	NSB010-2123*
22X24 mm	156,34	1	NSB010-2224*
24X27 mm	169,77	1	NSB010-2427
25X28 mm	189,36	1	NSB010-2528*
26X28 mm	200,31	1	NSB010-2628*
27X30 mm	211,25	1	NSB010-2730*
27X32 mm	218,75	1	NSB010-2732*
30X32 mm	246,38	1	NSB010-3032
30X36 mm	307,98	1	NSB010-3036*
32X36 mm	369,56	1	NSB010-3236*
36X41 mm	554,34	1	NSB010-3641
41X46 mm	669,82	1	NSB010-4146
46X50 mm	753,55	1	NSB010-4650*

BAM/ZBF/003/21

Llaves fijas estrella acodada anti chispa, AL-BR



**NS011**

	€		
6x7 mm	25,60	1	NS011-0607
8x9 mm	27,63	1	NS011-0809
10x11 mm	33,44	1	NS011-1011
12x13 mm	43,63	1	NS011-1213
14x15 mm	49,45	1	NS011-1415
16x17 mm	53,81	1	NS011-1617
18x19 mm	66,89	1	NS011-1819
20x22 mm	78,51	1	NS011-2022
21x23 mm	81,45	1	NS011-2123
24x26 mm	99,73	1	NS011-2426
25x28 mm	99,73	1	NS011-2528
27x29 mm	109,82	1	NS011-2729
30x32 mm	134,48	1	NS011-3032

BAM/ZBF/002/21

Llaves fijas estrella acodada anti chispa, CU-BE



**NSB011**

	€		
6x7 mm	30,54	1	NSB011-0607
8x9 mm	32,97	1	NSB011-0809
10x11 mm	42,18	1	NSB011-1011
12x13 mm	61,08	1	NSB011-1213
14x15 mm	75,61	1	NSB011-1415
16x17 mm	87,24	1	NSB011-1617
18x19 mm	110,51	1	NSB011-1819
20x22 mm	133,77	1	NSB011-2022
21x23 mm	139,59	1	NSB011-2123
24x26 mm	172,54	1	NSB011-2426
25x28 mm	173,06	1	NSB011-2528*
27x29 mm	187,58	1	NSB011-2729*
30x32 mm	232,65	1	NSB011-3032

BAM/ZBF/003/21



Llave de golpe boca fija anti chispa, AL-BR



**NS100**

	€		
17 mm	79,47	1	NS100-17
19 mm	82,64	1	NS100-19
22 mm	85,83	1	NS100-22
24 mm	92,17	1	NS100-24
25 mm	103,33	1	NS100-25*
27 mm	104,29	1	NS100-27
28 mm	105,29	1	NS100-28
29 mm	108,07	1	NS100-29*
30 mm	109,10	1	NS100-30
32 mm	114,83	1	NS100-32
33 mm	121,59	1	NS100-33*
34 mm	144,42	1	NS100-34
35 mm	151,00	1	NS100-35*
36 mm	152,44	1	NS100-36





	€		
37 mm	166,89	1	NS100-37*
38 mm	168,47	1	NS100-38
41 mm	182,77	1	NS100-41
42 mm	214,20	1	NS100-42
45 mm	230,47	1	NS100-45*
46 mm	232,67	1	NS100-46
47 mm	250,34	1	NS100-47*
50 mm	270,20	1	NS100-50
52 mm	297,23	1	NS100-52
54 mm	309,95	1	NS100-54
55 mm	309,95	1	NS100-55
56 mm	324,70	1	NS100-56
58 mm	389,39	1	NS100-58
60 mm	393,11	1	NS100-60
63 mm	417,07	1	NS100-63*
65 mm	429,14	1	NS100-65
67 mm	510,87	1	NS100-67*
70 mm	564,24	1	NS100-70
71 mm	591,12	1	NS100-71*
75 mm	635,39	1	NS100-75
77 mm	709,36	1	NS100-77*
80 mm	749,28	1	NS100-80
82 mm	821,65	1	NS100-82
85 mm	853,74	1	NS100-85
88 mm	967,26	1	NS100-88*
90 mm	872,47	1	NS100-90
94 mm	894,45	1	NS100-94*
95 mm	872,47	1	NS100-95
100 mm	1.339,31	1	NS100-100
105 mm	1.629,35	1	NS100-105
110 mm	1.442,94	1	NS100-110
115 mm	1.729,04	1	NS100-115
120 mm	1.849,40	1	NS100-120



BAM/ZBF/002/21

Llave de golpe boca fija anti chispa,  
CU-BE



### NSB100

	€		
17 mm	104,05	1	NSB100-17*
19 mm	108,23	1	NSB100-19*
22 mm	112,39	1	NSB100-22
24 mm	120,73	1	NSB100-24
25 mm	135,27	1	NSB100-25
27 mm	135,27	1	NSB100-27
28 mm	135,27	1	NSB100-28
29 mm	166,49	1	NSB100-29*
30 mm	166,49	1	NSB100-30
32 mm	167,89	1	NSB100-32
33 mm	187,32	1	NSB100-33
34 mm	187,32	1	NSB100-34*
35 mm	197,71	1	NSB100-35
36 mm	197,71	1	NSB100-36



	€		
37 mm	218,52	1	NSB100-37*
38 mm	218,52	1	NSB100-38
41 mm	239,34	1	NSB100-41
42 mm	275,23	1	NSB100-42
45 mm	301,77	1	NSB100-45
46 mm	301,77	1	NSB100-46
47 mm	327,77	1	NSB100-47*
50 mm	353,81	1	NSB100-50
52 mm	389,18	1	NSB100-52
54 mm	405,83	1	NSB100-54*
55 mm	405,83	1	NSB100-55
56 mm	422,11	1	NSB100-56*
58 mm	506,21	1	NSB100-58*
60 mm	511,07	1	NSB100-60*
63 mm	542,19	1	NSB100-63
65 mm	557,88	1	NSB100-65
67 mm	664,13	1	NSB100-67*
70 mm	733,51	1	NSB100-70*
71 mm	768,45	1	NSB100-71*
75 mm	826,01	1	NSB100-75*
77 mm	922,17	1	NSB100-77*
80 mm	974,06	1	NSB100-80
82 mm	1.068,12	1	NSB100-82
85 mm	1.109,85	1	NSB100-85*
88 mm	1.257,43	1	NSB100-88*
90 mm	1.405,02	1	NSB100-90
94 mm	1.440,47	1	NSB100-94*
95 mm	1.476,46	1	NSB100-95*
100 mm	1.599,46	1	NSB100-100*
105 mm	1.890,27	1	NSB100-105*
110 mm	2.035,73	1	NSB100-110*
115 mm	2.439,34	1	NSB100-115*
120 mm	2.609,18	1	NSB100-120*



BAM/ZBF/003/21

Llave estrella de golpeo anti chispa, AL-BR



### NS104

	€		
17 mm	86,60	1	NS104-17
19 mm	88,19	1	NS104-19
20 mm	88,96	1	NS104-20*
22 mm	89,75	1	NS104-22
24 mm	91,34	1	NS104-24
25 mm	102,66	1	NS104-25*
26 mm	102,71	1	NS104-26
27 mm	102,71	1	NS104-27
28 mm	107,76	1	NS104-28
29 mm	110,16	1	NS104-29
30 mm	114,43	1	NS104-30
31 mm	118,08	1	NS104-31
32 mm	120,04	1	NS104-32

	€		
33 mm	131,71	1	NS104-33
34 mm	139,28	1	NS104-34
35 mm	142,91	1	NS104-35
36 mm	140,08	1	NS104-36
37 mm	140,73	1	NS104-37
38 mm	146,67	1	NS104-38
39 mm	177,31	1	NS104-39
40 mm	180,65	1	NS104-40
41 mm	183,66	1	NS104-41
42 mm	199,74	1	NS104-42
43 mm	204,95	1	NS104-43*
44 mm	199,74	1	NS104-44*
45 mm	203,22	1	NS104-45*
46 mm	208,43	1	NS104-46
47 mm	225,64	1	NS104-47
48 mm	229,57	1	NS104-48
49 mm	233,50	1	NS104-49
50 mm	237,42	1	NS104-50
51 mm	243,33	1	NS104-51
52 mm	249,30	1	NS104-52
53 mm	251,29	1	NS104-53*
54 mm	253,29	1	NS104-54
55 mm	270,57	1	NS104-55
56 mm	277,91	1	NS104-56
57 mm	282,56	1	NS104-57
58 mm	287,18	1	NS104-58*
59 mm	291,82	1	NS104-59*
60 mm	317,93	1	NS104-60
61 mm	329,23	1	NS104-61*
62 mm	335,86	1	NS104-62*
63 mm	346,39	1	NS104-63
64 mm	356,86	1	NS104-64*
65 mm	347,13	1	NS104-65
66 mm	337,75	1	NS104-66*
67 mm	343,17	1	NS104-67*
68 mm	414,31	1	NS104-68*
69 mm	414,31	1	NS104-69*
70 mm	392,33	1	NS104-70
71 mm	417,26	1	NS104-71*
72 mm	420,23	1	NS104-72*
73 mm	423,18	1	NS104-73*
74 mm	426,14	1	NS104-74*
75 mm	473,51	1	NS104-75
76 mm	492,49	1	NS104-76*
77 mm	498,64	1	NS104-77*
78 mm	513,19	1	NS104-78*
79 mm	527,76	1	NS104-79*
80 mm	542,33	1	NS104-80
81 mm	572,67	1	NS104-81*
82 mm	579,43	1	NS104-82*
83 mm	586,19	1	NS104-83*
84 mm	592,95	1	NS104-84*
85 mm	599,72	1	NS104-85
86 mm	664,33	1	NS104-86*
87 mm	678,97	1	NS104-87*
88 mm	693,59	1	NS104-88*
89 mm	708,24	1	NS104-89*
90 mm	667,29	1	NS104-90
92 mm	760,19	1	NS104-92*
94 mm	769,68	1	NS104-94*
95 mm	690,02	1	NS104-95
98 mm	818,70	1	NS104-98*
100 mm	811,75	1	NS104-100
105 mm	879,40	1	NS104-105
110 mm	1.041,76	1	NS104-110
115 mm	1.041,76	1	NS104-115
120 mm	1.352,92	1	NS104-120

BAM/ZBF/002/21

\* Hasta agotar existencias



Clave de estrella de golpe anti chispa, mm, CU-BE



**NSB104**

	€		
17 mm	101,48	1	NSB104-17
19 mm	104,18	1	NSB104-19
20 mm	109,59	1	NSB104-20*
22 mm	111,24	1	NSB104-22*
24 mm	112,27	1	NSB104-24
25 mm	133,50	1	NSB104-25*
26 mm	133,51	1	NSB104-26*
27 mm	142,05	1	NSB104-27
28 mm	140,08	1	NSB104-28*
29 mm	143,20	1	NSB104-29
30 mm	148,84	1	NSB104-30
31 mm	153,51	1	NSB104-31*
32 mm	162,35	1	NSB104-32
33 mm	153,51	1	NSB104-33*
34 mm	153,51	1	NSB104-34*
35 mm	153,51	1	NSB104-35*
36 mm	189,41	1	NSB104-36
37 mm	206,62	1	NSB104-37
38 mm	224,33	1	NSB104-38
39 mm	262,20	1	NSB104-39*
40 mm	276,28	1	NSB104-40*
41 mm	297,64	1	NSB104-41
42 mm	305,50	1	NSB104-42
43 mm	313,47	1	NSB104-43*
44 mm	305,50	1	NSB104-44
45 mm	310,82	1	NSB104-45*
46 mm	318,80	1	NSB104-46
47 mm	345,11	1	NSB104-47*
48 mm	351,11	1	NSB104-48
49 mm	357,12	1	NSB104-49
50 mm	372,06	1	NSB104-50
51 mm	372,06	1	NSB104-51*
52 mm	392,33	1	NSB104-52*
53 mm	384,30	1	NSB104-53*
54 mm	387,36	1	NSB104-54*
55 mm	412,65	1	NSB104-55
56 mm	425,05	1	NSB104-56*
57 mm	432,15	1	NSB104-57*
58 mm	439,22	1	NSB104-58*
59 mm	446,30	1	NSB104-59
60 mm	453,40	1	NSB104-60
61 mm	470,35	1	NSB104-61*
62 mm	479,82	1	NSB104-62*
63 mm	494,84	1	NSB104-63*
64 mm	509,81	1	NSB104-64*
65 mm	495,90	1	NSB104-65
66 mm	516,56	1	NSB104-66*
67 mm	524,82	1	NSB104-67*
68 mm	633,64	1	NSB104-68*
69 mm	633,64	1	NSB104-69*
70 mm	633,67	1	NSB104-70
71 mm	638,16	1	NSB104-71*
72 mm	642,69	1	NSB104-72*
73 mm	647,21	1	NSB104-73*
74 mm	651,75	1	NSB104-74*
75 mm	656,27	1	NSB104-75
76 mm	688,41	1	NSB104-76*

	€		
77 mm	697,00	1	NSB104-77*
78 mm	717,33	1	NSB104-78*
79 mm	737,74	1	NSB104-79*
80 mm	758,10	1	NSB104-80*
81 mm	800,50	1	NSB104-81*
82 mm	809,94	1	NSB104-82*
83 mm	819,39	1	NSB104-83*
84 mm	828,83	1	NSB104-84*
85 mm	838,30	1	NSB104-85*
86 mm	828,64	1	NSB104-86*
87 mm	949,08	1	NSB104-87*
88 mm	969,53	1	NSB104-88*
89 mm	990,01	1	NSB104-89*
90 mm	932,75	1	NSB104-90*
92 mm	1.062,60	1	NSB104-92*
94 mm	1.075,90	1	NSB104-94*
95 mm	1.089,20	1	NSB104-95*
98 mm	1.252,12	1	NSB104-98*
100 mm	1.276,53	1	NSB104-100*
105 mm	1.354,85	1	NSB104-105*
110 mm	1.586,07	1	NSB104-110*
115 mm	2.380,28	1	NSB104-115*
120 mm	2.034,43	1	NSB104-120*

BAM/ZBF/003/21

Clave estrella de golpe anti chispa, AL-BR



**NS106**

	€		
5/8 in	62,44	1	NS106-20
11/16 in	79,25	1	NS106-22*
3/4 in	83,50	1	NS106-24*
25/32 in	89,46	1	NS106-25*
13/16 in	91,06	1	NS106-26
7/8 in	93,99	1	NS106-28
15/16 in	95,57	1	NS106-30
1 in	97,13	1	NS106-32*
1 1/16 in	100,26	1	NS106-34
1 1/8 in	103,40	1	NS106-36
1 3/16 in	106,40	1	NS106-38*
1 1/4 in	108,24	1	NS106-40
1 5/16 in	100,52	1	NS106-42
1 3/8 in	103,13	1	NS106-44*
1 13/32 in	105,54	1	NS106-45*
1 7/16 in	137,93	1	NS106-46
1 1/2 in	139,98	1	NS106-48
1 9/16 in	145,60	1	NS106-50*
1 5/8 in	176,26	1	NS106-52
1 11/16 in	159,42	1	NS106-54*
1 3/4 in	163,31	1	NS106-56*
1 13/16 in	202,92	1	NS106-58
1 7/8 in	221,57	1	NS106-60
1 15/16 in	201,84	1	NS106-62*
2 in	235,97	1	NS106-64
2 1/16 in	220,90	1	NS106-66*
2 1/8 in	233,62	1	NS106-68*
2 3/16 in	246,38	1	NS106-70*
2 13/64 in	246,38	1	NS106-71*
2 1/4 in	289,19	1	NS106-72

	€		
2 5/16 in	304,41	1	NS106-74*
2 3/8 in	311,16	1	NS106-76*
2 7/16 in	295,04	1	NS106-78*
2 1/2 in	324,71	1	NS106-80*
2 9/16 in	325,51	1	NS106-82*
2 5/8 in	338,22	1	NS106-84*
2 3/4 in	405,86	1	NS106-88*
2 13/16 in	417,77	1	NS106-90*
2 7/8 in	435,93	1	NS106-92*
2 15/16 in	459,99	1	NS106-94*
3 in	487,05	1	NS106-96
3 1/16 in	476,83	1	NS106-98*
3 1/8 in	653,93	1	NS106-100*
3 1/4 in	672,09	1	NS106-104*
3 3/8 in	688,88	1	NS106-108*
3 1/2 in	712,95	1	NS106-112*
3 9/16 in	753,83	1	NS106-114*
3 5/8 in	853,05	1	NS106-116*
3 3/4 in	889,46	1	NS106-120*
3 7/8 in	960,60	1	NS106-124*
3 15/16 in	1.037,44	1	NS106-126*
4 in	1.078,95	1	NS106-128*
4 1/8 in	1.120,44	1	NS106-132*
4 1/4 in	1.303,17	1	NS106-136*
4 5/16 in	1.335,72	1	NS106-138*
4 1/2 in	1.593,95	1	NS106-144*
4 9/16 in	1.613,62	1	NS106-146*
4 11/16 in	1.711,46	1	NS106-150*
4 7/8 in	1.912,82	1	NS106-156*
4 15/16 in	2.737,73	1	NS106-158*



BAM/ZBF/002/21

Clave de estrella de golpe anti chispa, pulgadas, CU-BE



**NSB106**

	€		
5/8 in	108,23	1	NSB106-20*
11/16 in	121,22	1	NSB106-22
3/4 in	127,70	1	NSB106-24*
25/32 in	99,53	1	NSB106-25*
13/16 in	114,01	1	NSB106-26*
7/8 in	135,80	1	NSB106-28
15/16 in	138,02	1	NSB106-30*
1 in	140,32	1	NSB106-32*
1.1/16 in	144,84	1	NSB106-34*
1.1/8 in	149,37	1	NSB106-36*
1.3/16 in	153,69	1	NSB106-38*
1.1/4 in	169,73	1	NSB106-40*
1.5/16 in	174,23	1	NSB106-42*
1.3/8 in	178,79	1	NSB106-44*
1.13/32 in	225,79	1	NSB106-45*
1.7/16 in	239,10	1	NSB106-46
1.1/2 in	242,65	1	NSB106-48*
1.9/16 in	252,37	1	NSB106-50*
1.5/8 in	269,59	1	NSB106-52*
1.11/16 in	290,87	1	NSB106-54*
1.3/4 in	297,64	1	NSB106-56*
1.13/16 in	326,59	1	NSB106-58*
1.7/8 in	365,29	1	NSB106-60*

	€		
1.15/16 in	378,82	1	NSB106-62*
2 in	397,57	1	NSB106-64*
2.1/16 in	378,82	1	NSB106-66*
2.1/8 in	392,33	1	NSB106-68*
2.3/16 in	405,86	1	NSB106-70*
2.13/64 in	410,97	1	NSB106-71*
2.1/4 in	440,19	1	NSB106-72*
2.5/16 in	440,19	1	NSB106-74*
2.3/8 in	454,38	1	NSB106-76*
2.7/16 in	511,35	1	NSB106-78*
2.1/2 in	518,04	1	NSB106-80*
2.9/16 in	497,85	1	NSB106-82*
2.5/8 in	543,11	1	NSB106-84*
2.3/4 in	678,89	1	NSB106-88*
2.13/16 in	679,80	1	NSB106-90*
2.7/8 in	754,59	1	NSB106-92
2.15/16 in	768,27	1	NSB106-94*
3 in	779,26	1	NSB106-96*
3.1/16 in	826,48	1	NSB106-98*
3.1/8 in	850,08	1	NSB106-100*
3.1/4 in	873,69	1	NSB106-104*
3.3/8 in	895,52	1	NSB106-108*
3.1/2 in	926,86	1	NSB106-112*
3.9/16 in	979,93	1	NSB106-114*
3.5/8 in	1.108,95	1	NSB106-116*
3.3/4 in	1.156,27	1	NSB106-120*
3.7/8 in	1.248,77	1	NSB106-124*
3.15/16 in	1.348,67	1	NSB106-126
4 in	1.402,64	1	NSB106-128*
4.1/8 in	1.456,61	1	NSB106-132*
4.1/4 in	1.694,12	1	NSB106-136*
4.5/16 in	1.736,47	1	NSB106-138*
4.1/2 in	2.072,14	1	NSB106-144*
4.9/16 in	2.831,92	1	NSB106-146*
4.11/16 in	2.902,68	1	NSB106-150*
4.7/8 in	2.911,10	1	NSB106-156*
4.15/16 in	3.558,54	1	NSB106-158*



BAM/ZBF/003/21

## HERRAMIENTAS PARA FONTANERÍA

Llave Stillson anti chispa, AL-BR



### NS200



	€		
25 mm	200 mm	202,36	1 NS200-200
30 mm	250 mm	234,99	1 NS200-250
40 mm	300 mm	254,60	1 NS200-300
50 mm	350 mm	300,28	1 NS200-350
60 mm	450 mm	508,59	1 NS200-450
75 mm	600 mm	750,18	1 NS200-600
85 mm	900 mm	1.292,86	1 NS200-900
110 mm	1200 mm	1.766,59	1 NS200-1200*

BAM/ZBF/002/21

Llave Stillson anti chispa, CU-BE



### NSB200

	€		
25 mm	200 mm	322,57	1 NSB200-200
30 mm	250 mm	374,61	1 NSB200-250
40 mm	300 mm	405,83	1 NSB200-300
50 mm	350 mm	478,67	1 NSB200-350
60 mm	450 mm	582,73	1 NSB200-450
75 mm	600 mm	874,08	1 NSB200-600
85 mm	900 mm	1.519,24	1 NSB200-900
110 mm	1200 mm	2.767,93	1 NSB200-1200

BAM/ZBF/003/21

Llave de válvulas larga anti chispa, AL-BR



### NS202

€		
370 mm	263,64	1 NS202-350

BAM/ZBF/002/21

Llave válvulas anti chispa, CU-BE



### NSB202



€		
375 mm	310,99	1 NSB202-350



BAM/ZBF/003/21

Llave para válvulas anti-chispa, AL-BR



### NS203

€		
215 mm	24 mm	88,27 1 NS203-200
215 mm	32 mm	132,33 1 NS203-215

€		
290 mm	36 mm	144,01 1 NS203-290
400 mm	48 mm	189,25 1 NS203-400
490 mm	60 mm	281,39 1 NS203-490
800 mm	60 mm	667,30 1 NS203-800

BAM/ZBF/002/21

Llave para válvulas anti-chispa, CU-BE



### NSB203



€		
215 mm	24 mm	132,12 1 NSB203-200
215 mm	32 mm	189,05 1 NSB203-215
290 mm	36 mm	219,99 1 NSB203-290
400 mm	48 mm	270,35 1 NSB203-400
490 mm	60 mm	401,94 1 NSB203-490
800 mm	60 mm	953,31 1 NSB203-800*

BAM/ZBF/003/21

Llave-gancho girador de válvulas anti chispa, AL-BR



### NS204

€		
200 mm	153,78	1 NS204-30
300 mm	209,28	1 NS204-32
250 mm	173,25	1 NS204-35
300 mm	209,28	1 NS204-40
350 mm	230,67	1 NS204-45
375 mm	254,03	1 NS204-48
400 mm	268,61	1 NS204-50
450 mm	279,33	1 NS204-55*
500 mm	297,82	1 NS204-60
550 mm	333,84	1 NS204-65
600 mm	373,75	1 NS204-70
650 mm	417,55	1 NS204-75*
700 mm	476,92	1 NS204-80
750 mm	537,26	1 NS204-85*
800 mm	564,52	1 NS204-90

BAM/ZBF/002/21

\* Hasta agotar existencias



Llave válvulas anti chispa, CU-BE



**NSB204**

Ø	L	€		
200 mm		241,39	1	NSB204-30
300 mm		331,88	1	NSB204-32*
250 mm		268,61	1	NSB204-35*
300 mm		331,88	1	NSB204-40*
350 mm		404,89	1	NSB204-45*
375 mm		438,97	1	NSB204-48*
400 mm		466,21	1	NSB204-50
450 mm		556,72	1	NSB204-55*
500 mm		599,56	1	NSB204-60
550 mm		683,25	1	NSB204-65*
600 mm		750,42	1	NSB204-70*
650 mm		835,09	1	NSB204-75*
700 mm		949,95	1	NSB204-80*
750 mm		1.057,01	1	NSB204-85*
800 mm		1.166,01	1	NSB204-90

BAM/ZBF/003/21

**LLAVES DE VASO Y CARRACAS ANTICHISPA**

Vaso anti-chispa 1/2", AL-BR



**NS220**

Ø	L	€		
6 mm	40 mm	65,25	1	NS220-06
7 mm	40 mm	66,89	1	NS220-07
8 mm	40 mm	68,52	1	NS220-08
9 mm	40 mm	70,14	1	NS220-09
10 mm	40 mm	71,79	1	NS220-10
11 mm	40 mm	73,40	1	NS220-11
12 mm	40 mm	75,05	1	NS220-12
13 mm	40 mm	76,68	1	NS220-13
14 mm	40 mm	78,32	1	NS220-14
15 mm	40 mm	79,94	1	NS220-15
16 mm	40 mm	81,58	1	NS220-16
17 mm	40 mm	88,10	1	NS220-17

Ø	L	€		
18 mm	42 mm	89,71	1	NS220-18
19 mm	42 mm	91,35	1	NS220-19
20 mm	42 mm	92,99	1	NS220-20
21 mm	43 mm	97,89	1	NS220-21
22 mm	43 mm	101,15	1	NS220-22
23 mm	43 mm	104,41	1	NS220-23
24 mm	43 mm	110,92	1	NS220-24
25 mm	43 mm	114,20	1	NS220-25
26 mm	43 mm	122,35	1	NS220-26
27 mm	46 mm	127,26	1	NS220-27
28 mm	46 mm	130,51	1	NS220-28
29 mm	46 mm	142,39	1	NS220-29
30 mm	46 mm	143,56	1	NS220-30
32 mm	46 mm	146,83	1	NS220-32
34 mm	50 mm	127,11	1	NS220-34*
36 mm	50 mm	139,82	1	NS220-36
41 mm	55 mm	169,94	1	NS220-41

BAM/ZBF/002/21

Vaso anti-chispa 1/2", CU-BE



**NSB220**

Ø	L	€		
6 mm	40 mm	73,80	1	NSB220-06
7 mm	40 mm	75,63	1	NSB220-07
8 mm	40 mm	77,49	1	NSB220-08
9 mm	40 mm	79,34	1	NSB220-09
10 mm	40 mm	73,54	1	NSB220-10
11 mm	40 mm	77,34	1	NSB220-11
12 mm	40 mm	82,41	1	NSB220-12
13 mm	41 mm	86,22	1	NSB220-13
14 mm	40 mm	87,48	1	NSB220-14
15 mm	40 mm	90,02	1	NSB220-15
16 mm	40 mm	93,18	1	NSB220-16
17 mm	41 mm	95,73	1	NSB220-17
18 mm	42 mm	98,89	1	NSB220-18
19 mm	42 mm	103,34	1	NSB220-19
20 mm	42 mm	104,61	1	NSB220-20
21 mm	43 mm	107,76	1	NSB220-21
22 mm	43 mm	111,57	1	NSB220-22
23 mm	44 mm	118,08	1	NSB220-23
24 mm	43 mm	125,45	1	NSB220-24
25 mm	44 mm	140,73	1	NSB220-25
26 mm	43 mm	150,88	1	NSB220-26
27 mm	47 mm	158,49	1	NSB220-27
28 mm	46 mm	167,36	1	NSB220-28
29 mm	47 mm	180,29	1	NSB220-29
30 mm	46 mm	186,38	1	NSB220-30
32 mm	47 mm	204,76	1	NSB220-32

BAM/ZBF/003/21

Vaso anti-chispa 3/4", AL-BR



**NS224**

Ø	L	€		
17 mm	50 mm	89,49	1	NS224-17
18 mm	50 mm	89,76	1	NS224-18*
19 mm	50 mm	90,04	1	NS224-19
21 mm	55 mm	99,03	1	NS224-21*
22 mm	55 mm	100,10	1	NS224-22
23 mm	55 mm	105,74	1	NS224-23
24 mm	55 mm	132,72	1	NS224-24
26 mm	55 mm	134,12	1	NS224-26*
27 mm	55 mm	142,28	1	NS224-27
28 mm	55 mm	149,39	1	NS224-28*
29 mm	55 mm	159,74	1	NS224-29
30 mm	60 mm	168,46	1	NS224-30
32 mm	60 mm	190,26	1	NS224-32
34 mm	60 mm	205,54	1	NS224-34
36 mm	60 mm	219,15	1	NS224-36
38 mm	60 mm	234,43	1	NS224-38
41 mm	65 mm	258,42	1	NS224-41
46 mm	65 mm	305,28	1	NS224-46
50 mm	70 mm	334,74	1	NS224-50

BAM/ZBF/002/21

Vaso anti-chispa 3/4", CU-BE



**NSB224**

Ø	L	€		
17 mm	50 mm	123,31	1	NSB224-17
18 mm	50 mm	152,13	1	NSB224-18*
19 mm	50 mm	123,87	1	NSB224-19
21 mm	55 mm	136,40	1	NSB224-21*
22 mm	55 mm	139,67	1	NSB224-22
23 mm	55 mm	174,63	1	NSB224-23*
24 mm	56 mm	156,83	1	NSB224-24
26 mm	55 mm	163,18	1	NSB224-26*
27 mm	55 mm	166,05	1	NSB224-27*
28 mm	55 mm	176,21	1	NSB224-28
29 mm	55 mm	213,50	1	NSB224-29*
30 mm	60 mm	226,44	1	NSB224-30
32 mm	61 mm	255,28	1	NSB224-32
34 mm	60 mm	274,69	1	NSB224-34*
36 mm	61 mm	295,10	1	NSB224-36
38 mm	60 mm	315,02	1	NSB224-38*
41 mm	66 mm	346,35	1	NSB224-41



Ø	L	€		
46 mm	65 mm	409,55	1	NSB224-46
50 mm	71 mm	448,86	1	NSB224-50

BAM/ZBF/003/21

### Vaso anti-chispa 1", AL-BR



### NS228

Ø	L	€		
22 mm	55 mm	131,47	1	NS228-22
24 mm	55 mm	145,18	1	NS228-24
26 mm	55 mm	179,45	1	NS228-26*
27 mm	55 mm	185,66	1	NS228-27*
28 mm	55 mm	189,41	1	NS228-28*
29 mm	55 mm	193,77	1	NS228-29*
30 mm	60 mm	198,12	1	NS228-30*
31 mm	60 mm	214,33	1	NS228-31*
32 mm	60 mm	229,28	1	NS228-32
34 mm	60 mm	241,75	1	NS228-34*
36 mm	65 mm	259,20	1	NS228-36
38 mm	65 mm	279,12	1	NS228-38*
41 mm	70 mm	317,13	1	NS228-41
46 mm	75 mm	352,65	1	NS228-46
50 mm	75 mm	387,54	1	NS228-50
55 mm	80 mm	437,38	1	NS228-55
60 mm	85 mm	488,47	1	NS228-60
65 mm	90 mm	542,05	1	NS228-65
70 mm	90 mm	596,89	1	NS228-70
75 mm	95 mm	651,71	1	NS228-75*
80 mm	95 mm	708,41	1	NS228-80*

BAM/ZBF/002/21

### Vaso anti-chispa 1", CU-BE



### NSB228

Ø	g	€		
22 mm	370 g	175,26	1	NSB228-22*
24 mm	430 g	202,93	1	NSB228-24*
26 mm	396 g	221,39	1	NSB228-26*
27 mm	440 g	239,85	1	NSB228-27*
28 mm	411 g	236,77	1	NSB228-28*
29 mm	460 g	276,72	1	NSB228-29*
30 mm	462 g	295,17	1	NSB228-30*

Ø	g	€		
31 mm	520 g	278,25	1	NSB228-31*
32 mm	497 g	311,78	1	NSB228-32*
34 mm	506 g	368,97	1	NSB228-34*
36 mm	610 g	387,41	1	NSB228-36*
38 mm	600 g	405,86	1	NSB228-38*
41 mm	740 g	415,09	1	NSB228-41*
46 mm	832 g	451,99	1	NSB228-46
50 mm	960 g	479,63	1	NSB228-50
55 mm	1130 g	525,79	1	NSB228-55*
60 mm	1570 g	654,93	1	NSB228-60*
65 mm	1698 g	701,04	1	NSB228-65*
70 mm	2350 g	774,84	1	NSB228-70*
75 mm	3010 g	920,58	1	NSB228-75*
80 mm	2818 g	977,76	1	NSB228-80*

BAM/ZBF/003/21

### Adaptador anti-chispa, AL-BR



### NS232

Ø	Ø	€		
1/2"	3/4"	127,74	1	NS232-16-24
3/4"	1/2"	155,81	1	NS232-24-16
3/4"	1"	260,63	1	NS232-24-32*
1"	3/4"	253,07	1	NS232-32-24

BAM/ZBF/002/21

### Adaptador anti-chispa, CU-BE



### NSB232

Ø	Ø	€		
1/2"	3/4"	182,13	1	NSB232-16-24
3/4"	1/2"	219,87	1	NSB232-24-16
3/4"	1"	370,42	1	NSB232-24-32
1"	3/4"	358,54	1	NSB232-32-24

BAM/ZBF/003/21

### Alargadera anti-chispa, AL-BR



### NS234

Ø	Ø	€		
1/2"	1/2"	123,87	1	NS234-16-100
1/2"	1/2"	136,02	1	NS234-16-200
1/2"	1/2"	149,39	1	NS234-16-250
3/4"	3/4"	204,01	1	NS234-24-200
1"	1"	352,20	1	NS234-32-250

BAM/ZBF/002/21

### Alargadera anti-chispa, CU-BE



### NSB234

L	Ø	€		
100 mm	16.4 mm	155,50	1	NSB234-16-100
200 mm	16.4 mm	172,24	1	NSB234-16-200
250 mm	16.4 mm	167,46	1	NSB234-16-250
200 mm	25 mm	241,61	1	NSB234-24-200
250 mm	34 mm	503,16	1	NSB234-32-250

BAM/ZBF/003/21

### Junta universal anti-chispa, AL-BR



### NS236

Ø	Ø	€		
1/2"	1/2"	151,40	1	NS236-16
3/4"	3/4"	365,41	1	NS236-24*
1"	1"	499,06	1	NS236-32*

BAM/ZBF/002/21

\* Hasta agotar existencias



Junta universal anti-chispa, CU-BE



**NSB236**

1/2"	3/4"	1"	€	1	NSB236-16
1/2"	3/4"	1"	230,88	1	NSB236-16
3/4"	1"		478,45	1	NSB236-24*
1"			728,54	1	NSB236-32*

BAM/ZBF/003/21

Mango acodado en T anti-chispa, AL-BR



**NS240**

1/2"	230 mm	€	1	NS240-16-230
1/2"	230 mm	195,62	1	NS240-16-230

BAM/ZBF/002/21

Llave de carraca anti-chispa, CU-BE



**NSB242**

1/2"	245 mm	€	1	NSB242-16
1/2"	245 mm	263,14	1	NSB242-16
3/4"	320 mm	526,29	1	NSB242-24
1"	550 mm	1.100,41	1	NSB242-32*

BAM/ZBF/003/21

Mango corredizo en T anti-chispa, AL-BR



**NS238**

1/2"	250 mm	€	1	NS238-16-250
1/2"	250 mm	212,54	1	NS238-16-250
3/4"	260 mm	421,41	1	NS238-24-250
1"	300 mm	529,51	1	NS238-32-300*

BAM/ZBF/002/21

Mango acodado en T anti-chispa, CU-BE



**NSB240**

1/2"	370 g	€	1	NSB240-16-230*
1/2"	370 g	225,79	1	NSB240-16-230*

BAM/ZBF/003/21

Berbiquí anti-chispa, AL-BR



**NS243**

1/2"	390 mm	€	1	NS243-16-400
1/2"	390 mm	249,17	1	NS243-16-400

BAM/ZBF/002/21

Mango corredizo en T anti-chispa, CU-BE



**NSB238**

1/2"	250 mm	€	1	NSB238-16-250
1/2"	250 mm	179,41	1	NSB238-16-250
3/4"	250 mm	275,10	1	NSB238-24-250*
1"	300 mm	502,37	1	NSB238-32-300*

BAM/ZBF/003/21

Llave de carraca anti-chispa, AL-BR



**NS242**

1/2"	245 mm	€	1	NS242-16
1/2"	245 mm	318,19	1	NS242-16
3/4"	320 mm	511,29	1	NS242-24
1"	550 mm	991,81	1	NS242-32*

BAM/ZBF/002/21

Berbiquí anti-chispa, CU-BE



**NSB243**

1/2"	395 mm	€	1	NSB243-16-400
1/2"	395 mm	349,40	1	NSB243-16-400

BAM/ZBF/003/21

Vaso anti-chipa para bujías, AL-BR



**NS247**

		€		
1/2"	13 mm	150,71	1	NS247-26*

BAM/ZBF/002/21

Vaso anti-chipa para bujías, CU-BE



**NSB247**

		€		
1/2"	13 mm	227,26	1	NSB247-26*

BAM/ZBF/003/21

Destornillador Stecker anti-chispa, AL-BR



**NS248**

	€		
13 mm	80,68	1	NS248-16-52*

BAM/ZBF/002/21

Destornillador Stecker anti-chispa, CU-BE



**NSB248**

	€		
13 mm	113,98	1	NSB248-16-52*

BAM/ZBF/003/21

## DESTORNILLADORES ANTICHISPA

Destornillador punta plana ERGO™, AL-BR



**ergo**



**NS300**

		€		
3 mm	50 mm	17,45	1	NS300-3-50
3 mm	75 mm	20,35	1	NS300-3-75
4 mm	75 mm	21,82	1	NS300-4-75
4.5 mm	50 mm	18,91	1	NS300-4.5-50
4.5 mm	100 mm	26,44	1	NS300-4.5-100
5 mm	75 mm	23,27	1	NS300-5-75
5 mm	100 mm	26,16	1	NS300-5-100
6 mm	100 mm	27,63	1	NS300-6-100
6 mm	125 mm	31,30	1	NS300-6-125
6 mm	150 mm	34,58	1	NS300-6-150
7 mm	150 mm	39,14	1	NS300-7-150
8 mm	150 mm	42,58	1	NS300-8-150
8 mm	200 mm	50,91	1	NS300-8-200
9 mm	250 mm	58,17	1	NS300-9-250
10 mm	200 mm	73,66	1	NS300-10-200
10 mm	300 mm	96,05	1	NS300-10-300
11 mm	250 mm	88,04	1	NS300-11-250
11 mm	300 mm	104,05	1	NS300-11-300
11 mm	350 mm	120,06	1	NS300-11-350
12 mm	400 mm	126,46	1	NS300-12-400
13 mm	450 mm	136,07	1	NS300-13-450

BAM/ZBF/002/21

Destornillador boca Plana ERGO™ anti chispa, CU-BE



**ergo**



**NSB300**

		€		
3 mm	50 mm	21,63	1	NSB300-3-50
3 mm	75 mm	21,82	1	NSB300-3-75
4 mm	75 mm	27,63	1	NSB300-4-75
4.5 mm	60 mm	24,71	1	NSB300-4.5-50
4.5 mm	95 mm	28,56	1	NSB300-4.5-100
5 mm	75 mm	30,34	1	NSB300-5-75
5 mm	100 mm	29,09	1	NSB300-5-100
6 mm	105 mm	34,91	1	NSB300-6-100
6 mm	125 mm	34,91	1	NSB300-6-125
6 mm	160 mm	42,46	1	NSB300-6-150
7 mm	150 mm	42,46	1	NSB300-7-150
8 mm	150 mm	43,63	1	NSB300-8-150
8 mm	200 mm	67,21	1	NSB300-8-200
9 mm	250 mm	79,61	1	NSB300-9-250
9 mm	200 mm	94,51	1	NSB300-10-200
10 mm	318 mm	101,78	1	NSB300-10-300
11 mm	250 mm	109,06	1	NSB300-11-250
11 mm	300 mm	116,32	1	NSB300-11-300
11 mm	350 mm	145,41	1	NSB300-11-350
12 mm	400 mm	174,49	1	NSB300-12-400
13 mm	450 mm	203,57	1	NSB300-13-450

BAM/ZBF/003/21

Destornilladores electricista anti chispa, AL-BR



**ergo**



**NS301**

		€		
3 mm	50 mm	21,82	1	NS301-3-50
4 mm	100 mm	27,63	1	NS301-4-100
4 mm	150 mm	46,11	1	NS301-4-150
5 mm	100 mm	43,12	1	NS301-5-100
5 mm	200 mm	46,21	1	NS301-5-200
6 mm	100 mm	46,34	1	NS301-6-100
8 mm	150 mm	62,74	1	NS301-8-150
10 mm	200 mm	78,47	1	NS301-10-200
10 mm	300 mm	93,27	1	NS301-10-300

BAM/ZBF/002/21

\* Hasta agotar existencias



Destornilladores electricista, CU-BE



ergo



NSB301

Ø	L	€	Box	Box
3 mm	50 mm	31,75	1	NSB301-3-50
4 mm	100 mm	41,40	1	NSB301-4-100
4 mm	150 mm	54,51	1	NSB301-4-150
5 mm	100 mm	50,75	1	NSB301-5-100
5 mm	210 mm	72,72	1	NSB301-5-200
6 mm	100 mm	72,72	1	NSB301-6-100
8 mm	155 mm	87,24	1	NSB301-8-150
10 mm	200 mm	83,71	1	NSB301-10-200
10 mm	300 mm	103,13	1	NSB301-10-300

BAM/ZBF/003/21

Destornillador punta PH ERGO™, AL-BR



ergo



NS302

Ø	L	€	Box	Box
PH0	50 mm	24,71	1	NS302-0-50
PH1	100 mm	24,71	1	NS302-1-100
PH2	125 mm	31,49	1	NS302-2-125
PH3	150 mm	43,63	1	NS302-3-150
PH4	300 mm	69,80	1	NS302-4-300

BAM/ZBF/002/21

Destornilladores Phillips ERGO™ anti chispa, CU-BE



ergo



NSB302

Ø	L	€	Box	Box
PH0	65 mm	31,99	1	NSB302-0-50
PH1	120 mm	31,99	1	NSB302-1-100
PH2	125 mm	34,91	1	NSB302-2-125
PH3	150 mm	50,91	1	NSB302-3-150
PH4	300 mm	79,99	1	NSB302-4-300

BAM/ZBF/003/21

Destornillador punta PZ ERGO™, AL-BR



ergo



NS304

Ø	L	€	Box	Box
PZ0	50 mm	24,71	1	NS304-0-50
PZ1	100 mm	24,71	1	NS304-1-100
PZ2	125 mm	29,09	1	NS304-2-125
PZ3	150 mm	43,63	1	NS304-3-150
PZ4	300 mm	69,80	1	NS304-4-300

BAM/ZBF/002/21

Destornillador PZ ERGO™ anti chispa, CU-BE



ergo



NSB304

Ø	L	€	Box	Box
PZ0	50 mm	31,99	1	NSB304-0-50
PZ1	100 mm	31,99	1	NSB304-1-100
PZ2	125 mm	34,91	1	NSB304-2-125
PZ3	150 mm	43,63	1	NSB304-3-150
PZ4	300 mm	79,99	1	NSB304-4-300

BAM/ZBF/003/21

Llaves allen anti chispa, AL-BR



NS320

Ø	L	€	Box	Box
2 mm	59 mm	31,67	1	NS320-2
3 mm	59 mm	32,05	1	NS320-3
4 mm	65 mm	32,56	1	NS320-4
5 mm	79 mm	33,97	1	NS320-5
6 mm	85 mm	35,42	1	NS320-6
7 mm	88 mm	39,22	1	NS320-7
8 mm	92 mm	41,15	1	NS320-8
9 mm	99 mm	45,47	1	NS320-9
10 mm	110 mm	48,83	1	NS320-10

BAM/ZBF/002/21

Llaves hexagonales anti chispa, CU-BE



NSB320

Ø	L	€	Box	Box
2 mm	59 mm	45,23	1	NSB320-2
3 mm	59 mm	45,77	1	NSB320-3
4 mm	65 mm	46,49	1	NSB320-4
5 mm	79 mm	48,51	1	NSB320-5
6 mm	85 mm	50,59	1	NSB320-6
7 mm	88 mm	56,01	1	NSB320-7
8 mm	93 mm	58,78	1	NSB320-8
9 mm	97 mm	64,93	1	NSB320-9
10 mm	110 mm	69,71	1	NSB320-10

BAM/ZBF/003/21

ALICATES ANTICHISPA

Alicates universal anti chispa, AL-BR



NS400

L	€	Box	Box
155 mm	130,86	1	NS400-160
175 mm	145,41	1	NS400-180
200 mm	159,96	1	NS400-200

BAM/ZBF/002/21

Alicates universal anti chispa, CU-BE



NSB400

L	€	Box	Box
157 mm	174,49	1	NSB400-160
175 mm	189,04	1	NSB400-180
200 mm	203,57	1	NSB400-200

BAM/ZBF/003/21



Alicates de corte lateral anti chispa, AL-BR

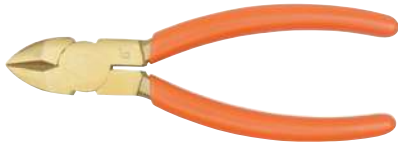

**NS402**

L	€	Icon	Icon
150 mm	169,95	1	NS402-160
200 mm	174,49	1	NS402-200

BAM/ZBF/002/21

Alicates de corte lateral anti chispa, CU-BE



**NSB402**

L	€	Icon	Icon
155 mm	212,27	1	NSB402-160
200 mm	261,48	1	NSB402-200

BAM/ZBF/003/21

Alicates corte diagonal HD anti chispa, AL-BR



**NS403**

L	€	Icon	Icon
150 mm	159,96	1	NS403-160
180 mm	174,49	1	NS403-180

BAM/ZBF/002/21

Alicates corte diagonal heavy duty anti chispa CU-BE



**NSB403**

L	€	Icon	Icon
155 mm	257,40	1	NSB403-160
180 mm	270,55	1	NSB403-180

BAM/ZBF/003/21

Alicates boca plana anti chispa, AL-BR



**NS404**

L	€	Icon	Icon
150 mm	123,59	1	NS404-160

BAM/ZBF/002/21

Alicates boca plana anti chispa, CU-BE



**NSB404**

L	€	Icon	Icon
155 mm	159,96	1	NSB404-160

BAM/ZBF/003/21

Alicates boca semirredonda anti chispa, AL-BR



**NS405**

L	€	Icon	Icon
160 mm	123,59	1	NS405-160

BAM/ZBF/002/21

Alicates boca redonda anti chispa, CU-BE



**NSB405**

L	€	Icon	Icon
155 mm	279,10	1	NSB405-160*

BAM/ZBF/003/21

Alicates de punta semiredonda anti chispa, AL-BR



**NS406**

L	€	Icon	Icon
160 mm	130,86	1	NS406-160
180 mm	156,69	1	NS406-180
200 mm	157,47	1	NS406-200

BAM/ZBF/002/21

Alicates de boca semirredonda anti chispa, CU-BE



**NSB406**

L	€	Icon	Icon
155 mm	174,49	1	NSB406-160
180 mm	203,12	1	NSB406-180
200 mm	203,57	1	NSB406-200

BAM/ZBF/003/21

Pelacables anti chispa, AL-BR



**NS407**

L	€	Icon	Icon
170 mm	285,26	1	NS407-160

BAM/ZBF/002/21

\* Hasta agotar existencias



Pelacables anti chispa, CU-BE

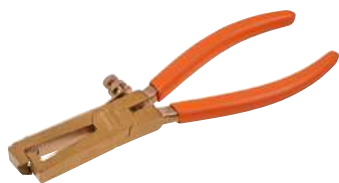

**NSB407**

L	€		
170 mm	383,25	1	NSB407-160

BAM/ZBF/003/21

Alicates articulado anti chispa, AL-BR



**NS408**

L	€		
260 mm	196,98	1	NS408-250
300 mm	238,54	1	NS408-300

BAM/ZBF/002/21

Tenacilla articulada anti chispa, CU-BE



**NSB408**

L	€		
255 mm	256,07	1	NSB408-250
300 mm	310,09	1	NSB408-300

BAM/ZBF/003/21

Tenazas anti chispa, AL-BR



**NS412**

L	€		
200 mm	116,32	1	NS412-200

BAM/ZBF/002/21

Tenazas anti chispa, CU-BE



**NSB412**

L	€		
200 mm	145,41	1	NSB412-200

BAM/ZBF/003/21

Alicates para gas anti chispa, AL-BR



**NS411**

L	€		
200 mm	189,04	1	NS411-200

BAM/ZBF/002/21

Alicates para Gas anti chispa, CU-BE



**NSB411**

L	€		
205 mm	374,61	1	NSB411-200

BAM/ZBF/003/21

Tenazas para carpinteros anti chispa, AL-BR



**NS413**

L	€		
180 mm	294,66	1	NS413-180
195 mm	294,66	1	NS413-200

BAM/ZBF/002/21

Tenazas para carpintero anti chispa, CU-BE



**NSB413**

L	€		
185 mm	383,06	1	NSB413-180*
195 mm	383,06	1	NSB413-200

BAM/ZBF/003/21

## MARTILLOS, PALANCAS Y CINCELES

Maza tipo alemán anti chispa, AL-BR



**NS500**

	€		
2000 g	279,73	1	NS500-2000
2500 g	349,56	1	NS500-2500
3000 g	419,40	1	NS500-3000
4000 g	555,95	1	NS500-4000

BAM/ZBF/002/21

Maceta cuadrada tipo alemán anti chispa mango madera, CU-BE



**NSB500**

	€		
2000 g	334,90	1	NSB500-2000
2500 g	394,72	1	NSB500-2500
3000 g	466,49	1	NSB500-3000
4000 g	468,23	1	NSB500-4000

BAM/ZBF/003/21

Maza tipo alemán mango fibra vidrio anti chispa



### NS500-FB

	€		
1000 g	160,10	1	NS500-1000-FB
1500 g	184,62	1	NS500-1500-FB
2000 g	226,05	1	NS500-2000-FB
2500 g	283,54	1	NS500-2500-FB
3000 g	319,91	1	NS500-3000-FB
3500 g	452,09	1	NS500-3500-FB

BAM/ZBF/002/21

Maceta cuadrada tipo alemán anti chispa mango fibra de vidrio, CU-BE



### NSB500-FB

	€		
1000 g	176,89	1	NSB500-1000-FB
1500 g	254,95	1	NSB500-1500-FB
2000 g	337,15	1	NSB500-2000-FB
2500 g	432,88	1	NSB500-2500-FB
3000 g	514,05	1	NSB500-3000-FB
3500 g	649,31	1	NSB500-3500-FB

BAM/ZBF/003/21

Maza mango fibra de vidrio anti chispa AL-BR



### NS502-FB

	€		
450 g	90,98	1	NS502-450-FB
1000 g	122,37	1	NS502-1000-FB
1500 g	162,35	1	NS502-1500-FB
2000 g	197,96	1	NS502-2000-FB

	€		
2500 g	251,95	1	NS502-2500-FB
3000 g	305,93	1	NS502-3000-FB
4500 g	365,29	1	NS502-4500-FB
5000 g	432,93	1	NS502-5000-FB
6800 g	568,23	1	NS502-6800-FB
8000 g	679,80	1	NS502-8000-FB
10000 g	947,05	1	NS502-10000-FB
12000 g	1.082,34	1	NS502-12000-FB*

BAM/ZBF/002/21

Martillo octogonal anti chispa mango fibra de vidrio, CU-BE



### NSB502-FB

	€		
450 g	121,31	1	NSB502-450-FB
1000 g	169,37	1	NSB502-1000-FB
1500 g	225,83	1	NSB502-1500-FB
2000 g	310,52	1	NSB502-2000-FB
2500 g	395,20	1	NSB502-2500-FB
3000 g	479,89	1	NSB502-3000-FB
4500 g	635,15	1	NSB502-4500-FB
5000 g	691,60	1	NSB502-5000-FB
6800 g	959,77	1	NSB502-6800-FB
8000 g	1.016,23	1	NSB502-8000-FB*
10000 g	1.488,22	1	NSB502-10000-FB
12000 g	2.030,78	1	NSB502-12000-FB

BAM/ZBF/003/21

Martillo tipo Alemán mango fibra de vidrio anti chispa, AL-BR



### NS504-FB

	€		
100 g	58,17	1	NS504-100-FB
200 g	61,80	1	NS504-200-FB
300 g	66,89	1	NS504-300-FB
500 g	91,61	1	NS504-500-FB
800 g	120,67	1	NS504-800-FB
1000 g	160,10	1	NS504-1000-FB
1500 g	189,04	1	NS504-1500-FB
2000 g	232,65	1	NS504-2000-FB

BAM/ZBF/002/21

Martillo mecánico anti chispa mango fibra de vidrio, CU-BE



### NSB504-FB

	€		
100 g	65,44	1	NSB504-100-FB
200 g	88,99	1	NSB504-200-FB
300 g	109,32	1	NSB504-300-FB
500 g	137,32	1	NSB504-500-FB
800 g	178,00	1	NSB504-800-FB
1000 g	216,15	1	NSB504-1000-FB
1500 g	292,45	1	NSB504-1500-FB
2000 g	353,48	1	NSB504-2000-FB

BAM/ZBF/003/21

Martillo de bola con mango de madera anti chispa, AL-BR



### NS506

	€		
340 g	56,51	1	NS506-300
450 g	75,34	1	NS506-450
670 g	105,97	1	NS506-700
910 g	141,26	1	NS506-900

BAM/ZBF/002/21

Martillo de bola con mango de madera anti chispa, CU-BE



### NSB506

	€		
300 g	76,30	1	NSB506-300
450 g	101,71	1	NSB506-450
680 g	143,05	1	NSB506-700
910 g	190,70	1	NSB506-900

BAM/ZBF/003/21

\* Hasta agotar existencias



Martillo de bola anti chispa con mango de fibra de vidrio, AL-BR



**NS506-FB**

	€		
310 g	57,37	1	NS506-300-FB
470 g	76,49	1	NS506-450-FB
700 g	96,88	1	NS506-700-FB
910 g	147,42	1	NS506-900-FB

BAM/ZBF/002/21

Martillo de bola anti chispa con mango de fibra de vidrio, CU-BE



**NSB506-FB**

	€		
300 g	77,77	1	NSB506-300-FB
450 g	103,67	1	NSB506-450-FB
680 g	130,79	1	NSB506-700-FB
900 g	199,02	1	NSB506-900-FB

BAM/ZBF/003/21

Martillos mango fibra de vidrio anti chispa, AL-BR



**NS508-FB**

	€		
500 g	91,41	1	NS508-500-FB
700 g	108,03	1	NS508-700-FB

BAM/ZBF/002/21

Martillos mango fibra de vidrio anti chispa, CU-BE



**NSB508-FB**

	€		
500 g	114,46	1	NSB508-500-FB
700 g	135,27	1	NSB508-700-FB

BAM/ZBF/003/21

Martillo anti chispa, AL-BR



**NS512-FB**

	€		
230 g	78,10	1	NS512-200-FB
400 g	98,06	1	NS512-400-FB
640 g	108,03	1	NS512-600-FB
970 g	131,28	1	NS512-900-FB

BAM/ZBF/002/21

Martillos mango fibra de vidrio anti chispa, CU-BE



**NSB512-FB**

	€		
200 g	97,82	1	NSB512-200-FB
400 g	122,78	1	NSB512-400-FB
600 g	135,27	1	NSB512-600-FB
900 g	191,38	1	NSB512-900-FB*

BAM/ZBF/003/21

Cuña anti chispa, AL-BR



**NS600**

L	€		
80 mm	10,17	1	NS600-80-13
100 mm	37,67	1	NS600-100-50
135 mm	71,58	1	NS600-135-50
150 mm	33,91	1	NS600-150-25
150 mm	30,16	1	NS600-150-30
150 mm	37,67	1	NS600-150-40
150 mm	64,05	1	NS600-150-50
180 mm	30,16	1	NS600-180-13
180 mm	43,32	1	NS600-180-32
180 mm	96,07	1	NS600-180-50
200 mm	84,77	1	NS600-200-20
200 mm	103,60	1	NS600-200-30
200 mm	152,08	1	NS600-200-40
200 mm	74,63	1	NS600-200-50
230 mm	109,26	1	NS600-230-40
250 mm	169,53	1	NS600-250-40
300 mm	331,54	1	NS600-300-50

BAM/ZBF/002/21

Cuña anti chispa, CU-BE



**NSB600**

L	€		
80 mm	13,74	1	NSB600-80-13
100 mm	50,86	1	NSB600-100-50
135 mm	96,63	1	NSB600-135-50
150 mm	45,78	1	NSB600-150-25
150 mm	48,69	1	NSB600-150-30
150 mm	52,62	1	NSB600-150-40*
150 mm	86,47	1	NSB600-150-50
180 mm	39,25	1	NSB600-180-13*
180 mm	58,48	1	NSB600-180-32
180 mm	129,70	1	NSB600-180-50
200 mm	114,44	1	NSB600-200-20
200 mm	139,86	1	NSB600-200-30
200 mm	217,60	1	NSB600-200-40*
200 mm	101,99	1	NSB600-200-50
230 mm	147,50	1	NSB600-230-40
250 mm	228,87	1	NSB600-250-40*
300 mm	447,58	1	NSB600-300-50

BAM/ZBF/003/21



Palanca anti chispa, AL-BR



**NS602**

Ø	L	€		
16 mm	460 mm	152,48	1	NS602-460
20 mm	600 mm	210,07	1	NS602-600
22 mm	760 mm	322,66	1	NS602-760
22 mm	935 mm	374,93	1	NS602-900

BAM/ZBF/002/21

Cinzel anti chispa, CU-BE



**NSB604**

L	€		
140 mm	132,56	1	NSB604-150*
200 mm	177,80	1	NSB604-200*
300 mm	353,47	1	NSB604-300*

BAM/ZBF/003/21

Granete mango moleteado anti chispa, AL-BR



**NS608**

L	€		
100 mm	34,86	1	NS608-100

BAM/ZBF/002/21

Palanca anti chispa, CU-BE



**NSB6028**

Ø	L	€		
16 mm	460 mm	308,77	1	NSB602-460
20 mm	600 mm	141,05	1	NSB602-600
22 mm	760 mm	640,44	1	NSB602-760
22 mm	920 mm	759,24	1	NSB602-900

BAM/ZBF/003/21

Cortafrios anti chispa AL-BR



**NS606**

L	€		
150 mm	56,92	1	NS606-150
200 mm	73,18	1	NS606-200
250 mm	98,93	1	NS606-250
300 mm	117,88	1	NS606-300
400 mm	151,79	1	NS606-400

BAM/ZBF/002/21

Granete anti chispa, CU-BE



**NSB608**

L	€		
100 mm	70,67	1	NSB608-100

BAM/ZBF/003/21

Buril anti chispa AL-BR



**NS604**

L	€		
140 mm	104,11	1	NS604-150
200 mm	167,01	1	NS604-200
300 mm	273,19	1	NS604-300

BAM/ZBF/002/21

Cinzel plano anti chispa, CU-BE



**NSB606**

L	€		
150 mm	89,64	1	NSB606-150
200 mm	115,27	1	NSB606-200
250 mm	155,82	1	NSB606-250
300 mm	211,33	1	NSB606-300
400 mm	272,03	1	NSB606-400

BAM/ZBF/003/21

**RASQUETAS**

Rasqueta en ángulo anti chispa, AL-BR



**NS700**

L	€		
45 mm	65,37	1	NS700-300

BAM/ZBF/002/21

\* Hasta agotar existencias



Rasqueta en ángulo anti chispa, CU-BE



**NSB700**

		€		
45 mm	310 mm	180,57	1	NSB700-300

BAM/ZBF/003/21

Rasqueta hojas largas anti chispa, AL-BR



**NS704**

		€		
100 mm	720 mm	124,25	1	NS704-225

BAM/ZBF/002/21

Rasqueta flexible anti chispa, CU-BE



**NSB706**

		€		
50 mm	200 mm	123,79	1	NSB706-50
80 mm	200 mm	189,94	1	NSB706-80

BAM/ZBF/003/21

Rasqueta plana anti chispa AL-BR



**NS702**

		€		
30 mm	325 mm	55,83	1	NS702-200

BAM/ZBF/002/21

Rasqueta de hoja larga anti chispa, CU-BE



**NSB704**

		€		
100 mm	720 mm	195,69	1	NSB704-225

BAM/ZBF/003/21

Rasqueta triangular anti chispa, AL-BR



**NS708**

		€		
440 mm		168,80	1	NS708-360

BAM/ZBF/002/21

Rasqueta plana anti chispa, CU-BE



**NSB702**

		€		
30 mm	325 mm	87,93	1	NSB702-200

BAM/ZBF/003/21

Rasqueta flexible anti chispa, AL-BR



**NS706**

		€		
50 mm	200 mm	78,59	1	NS706-50
80 mm	200 mm	120,60	1	NS706-80

BAM/ZBF/002/21

Rasqueta triangular anti chispa, CU-BE



**NSB708**

		€		
450 mm		228,81	1	NSB708-360

BAM/ZBF/003/21

Rasqueta triangular anti chispa, AL-BR



**NS710**

L	€		
470 mm	358,96	1	NS710-450

BAM/ZBF/002/21

Rasqueta triangular anti chispa, CU-BE



**NSB710**

L	€		
470 mm	486,53	1	NSB710-450

BAM/ZBF/003/21

**HERRAMIENTAS DE JARDINERÍA**

Pico anti chispa, AL-BR



**NS800**

L	€		
910 mm	172,97	1	NS800-1100
910 mm	252,87	1	NS800-1700
965 mm	301,73	1	NS800-2000

BAM/ZBF/002/21

Pico anti chispa, CU-BE



**NSB800**

L	g	€		
910 mm	2000 g	282,15	1	NSB800-1100
910 mm	2800 g	412,47	1	NSB800-1700
910 mm	3200 g	492,20	1	NSB800-2000

BAM/ZBF/003/21

Pala de punta redonda anti chispa, AL-BR



**NS802**

L	€		
1370 mm	229,82	1	NS802-290

BAM/ZBF/002/21

Pala redonda anti chispa, CU-BE



**NSB802**

L	€		
1450 mm	439,53	1	NSB802-290

BAM/ZBF/003/21

Cepillo de mano anti chispa, AL-BR



**NS804**

L	€		
290 mm	51,30	1	NS804-290

BAM/ZBF/002/21

**EXTRACTORES**

Extractores reversibles con tres garras anti chispa, AL-BR



**NS810**

		€		
50-100 mm	105 mm	1.090,78	1	NS810-100*
60-150 mm	175 mm	1.210,94	1	NS810-150*
70-200 mm	250 mm	1.293,84	1	NS810-200*
80-350 mm	320 mm	1.938,48	1	NS810-350*

BAM/ZBF/002/21

Extractores reversibles con tres garras anti chispa, CU-BE



**NSB810**

		€		
50-100 mm	105 mm	1.308,92	1	NSB810-100*
60-150 mm	175 mm	1.453,12	1	NSB810-150*
70-200 mm	250 mm	1.552,61	1	NSB810-200*
80-350 mm	320 mm	2.616,93	1	NSB810-350*

BAM/ZBF/003/21

\* Hasta agotar existencias



## LLAVES DINAMOMÉTRICAS ANTICHISPA

Llaves dinamo­métricas de disparo mecánico ajustable antichispa con visor de escala y cabeza fija de carraca de cobre al berilio

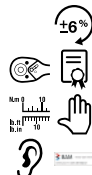

### NS041

		€		
1/4"	5-25 N·m	<b>1.561,55</b>	1	NS041-8-25
3/8"	10-50 N·m	<b>2.102,03</b>	1	NS041-12-50*
1/2"	20-100 N·m	<b>2.389,98</b>	1	NS041-16-100*
1/2"	40-200 N·m	<b>2.599,62</b>	1	NS041-16-200
1/2"	60-260 N·m	<b>2.804,63</b>	1	NS041-16-260
3/4"	150-670 N·m	<b>8.335,56</b>	1	NS041-24-670*
1"	200-900 N·m	<b>9.467,78</b>	1	NS041-32-900*

BAM/ZBF/002/21

Llaves dinamo­métricas de disparo mecánico ajustable antichispa con visor de escala y cabeza fija de carraca de bronce de aluminio

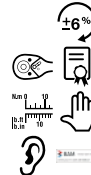

### NSB041

		€		
1/4"	5-25 N·m	<b>2.685,99</b>	1	NSB041-8-25
3/8"	10-50 N·m	<b>3.068,39</b>	1	NSB041-12-50
1/2"	20-100 N·m	<b>3.547,54</b>	1	NSB041-16-100*
1/2"	40-200 N·m	<b>3.804,40</b>	1	NSB041-16-200
1/2"	60-260 N·m	<b>4.061,24</b>	1	NSB041-16-260
3/4"	150-670 N·m	<b>12.622,56</b>	1	NSB041-24-670*
1"	200-900 N·m	<b>14.888,14</b>	1	NSB041-32-900*

BAM/ZBF/003/21





## Herramientas de acero inoxidable



## CARROS

Carro 7 cajones 26", acero inoxidable



**1470K7SS**



€



956 x 500 x 762 mm 2.276,30 1 1470K7SS

Carro 7 cajones 40", acero inoxidable



**1475KXL7SS**



€



986 x 501 x 1100 mm 4.328,19 1 1475KXL7SS

## LLAVES ACERO INOXIDABLE

Llave ajustable moleta central de acero inoxidable



**SS001**

L	Icon	€	Icon	Icon
100mm/4"	13 mm	93,64	1	SS001-100
150mm/6"	18 mm	105,53	1	SS001-150
200mm/8"	24 mm	153,71	1	SS001-200
250mm/10"	30 mm	189,80	1	SS001-250

L	Icon	€	Icon	Icon
300mm/12"	36 mm	251,31	1	SS001-300
375mm/15"	46 mm	390,25	1	SS001-375
450mm/18"	55 mm	461,24	1	SS001-450
600mm/24"	60 mm	773,14	1	SS001-600

Llaves combinadas de acero inoxidable, mm



**SS002**

Icon	€	Icon	Icon
7 mm	19,63	1	SS002-7
6 mm	13,41	1	SS002-6
8 mm	16,87	1	SS002-8
10 mm	20,95	1	SS002-10
11 mm	23,40	1	SS002-11
12 mm	24,64	1	SS002-12
13 mm	25,86	1	SS002-13
14 mm	27,10	1	SS002-14
15 mm	28,34	1	SS002-15
16 mm	29,57	1	SS002-16
17 mm	30,80	1	SS002-17
19 mm	32,03	1	SS002-19
21 mm	39,91	1	SS002-21
22 mm	43,11	1	SS002-22
24 mm	48,53	1	SS002-24
27 mm	70,23	1	SS002-27
32 mm	95,97	1	SS002-32

Juego de 6 llaves combinadas de acero inoxidable, mm



**SS002-6-2**

Icon	g	€	Icon	Icon
6	710 g	160,17	1	SS002-6-2

SS002-8, SS002-10, SS002-12, SS002-14, SS002-17, SS002-19

Set de 9 llaves combinadas de acero inoxidable, mm



**SS002-9-2**

Icon	g	€	Icon	Icon
9	924 g	236,55	1	SS002-9-2

SS002-8, SS002-10, SS002-11, SS002-12, SS002-13, SS002-14, SS002-15, SS002-17, SS002-19

Llave combinada acero inoxidable, pulgadas



**SS003**





Icon	L	€	Icon	Icon
1/4 in	105 mm	17,24	1	SS003-8
5/16 in	120 mm	18,74	1	SS003-10
11/32 in	135 mm	21,93	1	SS003-11
3/8 in	135 mm	24,03	1	SS003-12
7/16 in	150 mm	25,86	1	SS003-14
1/2 in	175 mm	28,34	1	SS003-16
9/16 in	175 mm	30,30	1	SS003-18
5/8 in	195 mm	32,03	1	SS003-20
11/16 in	195 mm	33,51	1	SS003-22
3/4 in	215 mm	35,11	1	SS003-24
25/32 in	215 mm	41,88	1	SS003-25
13/16 in	245 mm	44,36	1	SS003-26
7/8 in	245 mm	45,58	1	SS003-28
15/16 in	265 mm	54,21	1	SS003-30

Llave de estrella acodada de acero inoxidable, mm



**SS011**

Icon	L	€	Icon	Icon
5.5*7 mm	180 mm	27,80	1	SS011-0507*
6*7 mm	180 mm	28,43	1	SS011-0607*
8*9 mm	190 mm	29,21	1	SS011-0809*
8*10 mm	190 mm	29,50	1	SS011-0810*

		€		
9*11 mm	215 mm	31,32	1	SS011-0911*
10*12 mm	215 mm	31,82	1	SS011-1012*
12*14 mm	225 mm	34,75	1	SS011-1214*
14*17 mm	255 mm	40,17	1	SS011-1417*
16*18 mm	280 mm	45,07	1	SS011-1618*
17*19 mm	280 mm	49,30	1	SS011-1719*
17*22 mm	300 mm	65,59	1	SS011-1722*
22*24 mm	330 mm	75,14	1	SS011-2224*
24*27 mm	340 mm	95,42	1	SS011-2427*
24*30 mm	350 mm	135,72	1	SS011-2430*
30*32 mm	370 mm	164,38	1	SS011-3032*

Set de llaves de estrella acodadas de acero inoxidable, mm



### SS011-9-3

		€		
9	2470 g	633,20	1	SS011-9-3*

SS011-0810, SS011-1012, SS011-1214, SS011-1417, SS011-1719, SS011-1722, SS011-2224, SS011-2427, SS011-3032

Set de llaves de estrella acodadas de acero inoxidable, mm

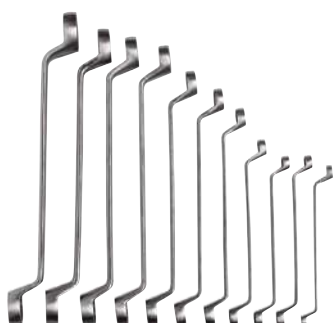

### SS011-11-3

		€		
11	3100 g	800,30	1	SS011-11-3*





SS011-0810, SS011-0911, SS011-1012, SS011-1214, SS011-1417, SS011-1719, SS011-1722, SS011-2224, SS011-2427, SS011-2430, SS011-3032

## LLAVES DE VASO Y CARRACAS ACERO INOXIDABLE

Vaso 1/4" hexagonal de acero inoxidable, en mm







### SS210

		€		
4 mm	25 mm	13,73	1	SS210-4
4.5 mm	25 mm	13,73	1	SS210-4.5
5 mm	25 mm	13,73	1	SS210-5
5.5 mm	25 mm	13,73	1	SS210-5.5
6 mm	25 mm	16,53	1	SS210-6
7 mm	25 mm	18,00	1	SS210-7
8 mm	25 mm	20,13	1	SS210-8
9 mm	25 mm	22,53	1	SS210-9
10 mm	25 mm	23,87	1	SS210-10
11 mm	25 mm	26,52	1	SS210-11
12 mm	26 mm	29,99	1	SS210-12
13 mm	26 mm	31,99	1	SS210-13
14 mm	26 mm	33,20	1	SS210-14

Vaso 1/2" hexagonal de acero inoxidable, en mm







### SS220

		€		
8 mm	40 mm	34,00	1	SS220-8
9 mm	40 mm	35,32	1	SS220-9
10 mm	40 mm	36,66	1	SS220-10
11 mm	40 mm	38,66	1	SS220-11
12 mm	40 mm	41,32	1	SS220-12
13 mm	40 mm	42,65	1	SS220-13
14 mm	40 mm	44,66	1	SS220-14
15 mm	40 mm	47,99	1	SS220-15
16 mm	40 mm	50,00	1	SS220-16
17 mm	40 mm	51,98	1	SS220-17
18 mm	42 mm	54,65	1	SS220-18
19 mm	42 mm	57,32	1	SS220-19
20 mm	42 mm	59,99	1	SS220-20
21 mm	43 mm	61,33	1	SS220-21
22 mm	43 mm	62,64	1	SS220-22
23 mm	43 mm	67,98	1	SS220-23
24 mm	43 mm	71,99	1	SS220-24
25 mm	43 mm	75,98	1	SS220-25
26 mm	43 mm	86,64	1	SS220-26
27 mm	46 mm	89,31	1	SS220-27
28 mm	46 mm	95,98	1	SS220-28
29 mm	46 mm	99,97	1	SS220-29
30 mm	46 mm	105,32	1	SS220-30
31 mm	46 mm	115,97	1	SS220-31
32 mm	46 mm	115,97	1	SS220-32

Vaso 3/4" hexagonal de acero inoxidable, en mm







### SS224

		€		
17 mm	50 mm	74,64	1	SS224-17
19 mm	50 mm	77,32	1	SS224-19
22 mm	55 mm	83,98	1	SS224-22
24 mm	55 mm	94,64	1	SS224-24
27 mm	55 mm	99,97	1	SS224-27
30 mm	60 mm	115,97	1	SS224-30
32 mm	60 mm	131,97	1	SS224-32
34 mm	60 mm	145,30	1	SS224-34
36 mm	60 mm	153,31	1	SS224-36
41 mm	65 mm	179,96	1	SS224-41
46 mm	65 mm	213,28	1	SS224-46
50 mm	70 mm	238,61	1	SS224-50
55 mm	75 mm	339,92	1	SS224-55
60 mm	75 mm	398,57	1	SS224-60
65 mm	80 mm	506,54	1	SS224-65

Extensión de acero inoxidable







### SS234

		€		
100 mm	1/2"	53,32	1	SS234-16-100
200 mm	1/2"	86,64	1	SS234-16-200
250 mm	1/2"	99,97	1	SS234-16-250
100 mm	3/4"	115,97	1	SS234-24-100
200 mm	3/4"	126,63	1	SS234-24-200
250 mm	3/4"	174,28	1	SS234-24-250

Junta universal de acero inoxidable



### SS236

		€		
56 mm	1/4"	63,63	1	SS236-08-80
80 mm	1/2"	86,64	1	SS236-16-80
110 mm	3/4"	153,31	1	SS236-24-110

\* Hasta agotar existencias



Mango corredizo en T de acero inoxidable



**SS238**

L	Ø	€		
250 mm	1/4"	117,31	1	SS238-08-250
250 mm	1/2"	118,64	1	SS238-16-250
350 mm	3/4"	166,62	1	SS238-24-350

Berbiquí de acero inoxidable



**SS243**

L	Ø	€		
300 mm	1/4"	56,62	1	SS243-08
390 mm	1/2"	132,73	1	SS243-16
450 mm	3/4"	336,30	1	SS243-24

Carraca de acero inoxidable



**SS242**

L	Ø	€		
200 mm	1/4"	153,31	1	SS242-08-200
245 mm	1/2"	159,96	1	SS242-16-245
320 mm	3/4"	313,26	1	SS242-24-320

**DESTORNILLADORES DE ACERO INOXIDABLE**

Destornillador de acero inoxidable ERGO™



**BE-8020i - BE-8252i**

Ø	L	€		
3.0 mm	60 mm	6,89	5	BE-8020I
3.5 mm	75 mm	7,43	5	BE-8030I
4.0 mm	100 mm	8,51	5	BE-8040I
5.5 mm	125 mm	10,82	5	BE-8241I
6.5 mm	150 mm	15,05	5	BE-8252I

Destornillador de acero inoxidable ERGO™



**BE-8600i - BE-8623i**

Ø	L	€		
PH 0	60 mm	8,34	5	BE-8600I
PH 1	75 mm	10,33	5	BE-8610I
PH 2	100 mm	14,49	5	BE-8620I
PH 3	150 mm	21,91	5	BE-8623I

Destornilladores ERGO™ de acero inoxidable



**BE-8800i - BE-8823i**

Ø	L	€		
PZ 0	60 mm	10,30	5	BE-8800I
PZ 1	75 mm	11,94	5	BE-8810I
PZ 2	100 mm	15,75	5	BE-8820I
PZ 3	150 mm	23,02	5	BE-8823I

Destornillador de acero inoxidable ERGO™



**BE-8910i - BE-8925i**

Ø	L	€		
T 10	75 mm	10,08	5	BE-8910I
T 15	100 mm	10,17	5	BE-8915I
T 20	100 mm	10,30	5	BE-8920I
T 25	125 mm	10,99	5	BE-8925I

Juego de 6 destornilladores ERGO™ de acero inoxidable



**BE-9881i**

X	€		
6	58,92	1	BE-9881I

BE-8020I, BE-8040I, BE-8241I, BE-8252I	
BE-8610I, BE-8620I	

Juego de 6 destornilladores ERGO™ inox.



**BE-9882i**

X	€		
6	61,48	1	BE-9882I

BE-8020I, BE-8040I, BE-8241I, BE-8252I	
BE-8810I, BE-8820I	



## LLAVES ALLEN DE ACERO INOXIDABLE

Llave L con bola de acero inoxidable, mm



### SS324

Ø	L	€		
1.5 mm	80 mm	4,34	1	SS324-1.5*
2 mm	85 mm	4,34	1	SS324-2*
2.5 mm	93 mm	4,34	1	SS324-2.5*
3 mm	103 mm	4,66	1	SS324-3*
4 mm	110 mm	5,10	1	SS324-4*
5 mm	123 mm	6,21	1	SS324-5*
6 mm	146 mm	6,88	1	SS324-6*
8 mm	168 mm	10,75	1	SS324-8*
10 mm	180 mm	13,30	1	SS324-10*

Juego de 9 llaves hexagonales con bola inoxidables, serie larga



### BE-9770i

Q	1.5; 2; 2.5; 3; 4; 5; 6; 8; 10 mm	€		
9		34,69	20	BE-9770I

SS324-1.5, SS324-2, SS324-2.5, SS324-3, SS324-4, SS324-5, SS324-6, SS324-8, SS324-10

Llave hexagonal en L con bola, en pulgadas



### SS325

Ø	L	€		
5/64" in	85 mm	5,55	1	SS325-2.5*
7/64" in	96 mm	7,40	1	SS325-3.5*
1/8" in	101 mm	6,10	1	SS325-4*
9/64" in	106 mm	9,86	1	SS325-4.5*
5/32" in	111 mm	6,65	1	SS325-5*
3/16" in	121 mm	8,87	1	SS325-6*
7/32" in	132 mm	9,43	1	SS325-7*
1/4" in	142 mm	9,98	1	SS325-8*
5/16" in	163 mm	11,65	1	SS325-10*
3/8" in	183 mm	14,41	1	SS325-12*
3/32" in	90 mm	5,55	1	SS325-3*

Juego de 13 llaves hexagonales inox. con bola serie larga, pulgadas



### BE-9786i

Q	0.05; 1/16; 5/64; 3/32; 7/64; 1/8; 9/64; 5/32; 3/16; 7/32; 1/4; 5/16; 3/8; in	€		
13		43,12	1	BE-9786I

SS325-2.5, SS325-3, SS325-3.5, SS325-4, SS325-4.5, SS325-5, SS325-6, SS325-7, SS325-8, SS325-10, SS325-12

## PUNTAS ACERO INOXIDABLE

Punta Phillips de acero inoxidable para destornilladores de torsión - 25 mm



### 65I/PH

Q		€		
10	1	28,89	1	65I/PH1*
2	1	6,82	1	65I/PH1-2P*
2	2	6,82	1	65I/PH2-2P*
10	3	28,89	1	65I/PH3*
2	3	6,82	1	65I/PH3-2P*

Punta Pozidriv de acero inoxidable para destornilladores de torsión - 25 mm



### 65I/PZ

Q		€		
10	1	28,89	1	65I/PZ1*
2	1	6,82	1	65I/PZ1-2P*
2	2	6,82	1	65I/PZ2-2P*
10	3	28,89	1	65I/PZ3*
2	3	6,82	1	65I/PZ3-2P*

Punta de torsión de acero inoxidable Torx® - 25 mm



### 65I/T

Q		€		
5	T15	16,52	1	65I/T15*
5	T40	16,52	1	65I/T40*
2	T40	7,51	1	65I/T40-2P*

Caja 5 Adaptadores universales de acero inoxidable de 1/4"



### KSR753

Q	1/4 in	€		
1		22,58	1	KSR753-1P*

-1P: Envase unitario soporte plástico

Juego 6 puntas de acero inoxidable Phillips, Pozidriv,



### 65I/7

Q	22 x 65 x 75 mm	€		
		27,15	1	65I/7-1*

65I/PH2

65I/PZ2

65I/T15, 65I/T20, 65I/T25, 65I/T30

\* Hasta agotar existencias



## ALICATES ACERO INOXIDABLE

Alicate universal de acero inoxidable



### SS400

L	€		
155 mm	61,73	1	SS400-160
175 mm	77,32	1	SS400-180
200 mm	98,64	1	SS400-200

Alicate de corte diagonal de acero inoxidable



### SS402

L	€		
150 mm	66,25	1	SS402-160
195 mm	72,12	1	SS402-200

Alicate dos posiciones de acero inoxidable



### SS412

L	€		
200 mm	99,97	1	SS412-200

Alicates de punta semirredonda de acero inoxidable



### SS406

L	€		
150 mm	66,65	1	SS406-160
175 mm	76,92	1	SS406-200

Tenacilla articulada de acero inoxidable



### SS410

L	€		
250 mm	102,64	1	SS410-250
300 mm	159,96	1	SS410-300

Mordaza de acero inoxidable



### SS415

L	€		
255 mm	153,31	1	SS415-225

## MARTILLOS DE ACERO INOXIDABLE

Martillo con bola de acero inoxidable



### SS506

L	€		
200 g	38,66	1	SS506-200-FB
300 g	51,98	1	SS506-300-FB
450 g	55,99	1	SS506-500-FB

L	€		
680 g	99,97	1	SS506-700-FB
900 g	115,97	1	SS506-900-FB
1100 g	131,97	1	SS506-1100-FB

Maza de acero inoxidable



### SS502

L	€		
1000 g	113,31	1	SS502-1000-FB
1500 g	159,96	1	SS502-1500-FB
2000 g	205,29	1	SS502-2000-FB
2500 g	258,60	1	SS502-2500-FB
3000 g	306,59	1	SS502-3000-FB*
3600 g	366,58	1	SS502-3600-FB

## CINCELES Y PUNTEROS DE CHAPISTA

Palanca de acero inoxidable



### SS603

L	€		
500 mm	82,65	1	SS603-15-500
500 mm	114,64	1	SS603-19-500
500 mm	117,85	1	SS603-20-500
500 mm	138,70	1	SS603-23-500
800 mm	213,28	1	SS603-23-800
600 mm	201,44	1	SS603-25-600
1000 mm	466,55	1	SS603-30-1000

Cinzel plano de acero inoxidable



### SS610

L	€		
160 mm	39,99	1	SS610-16-160
200 mm	57,99	1	SS610-18-200
300 mm	181,29	1	SS610-24-300
400 mm	283,93	1	SS610-25-400
500 mm	383,91	1	SS610-30-500

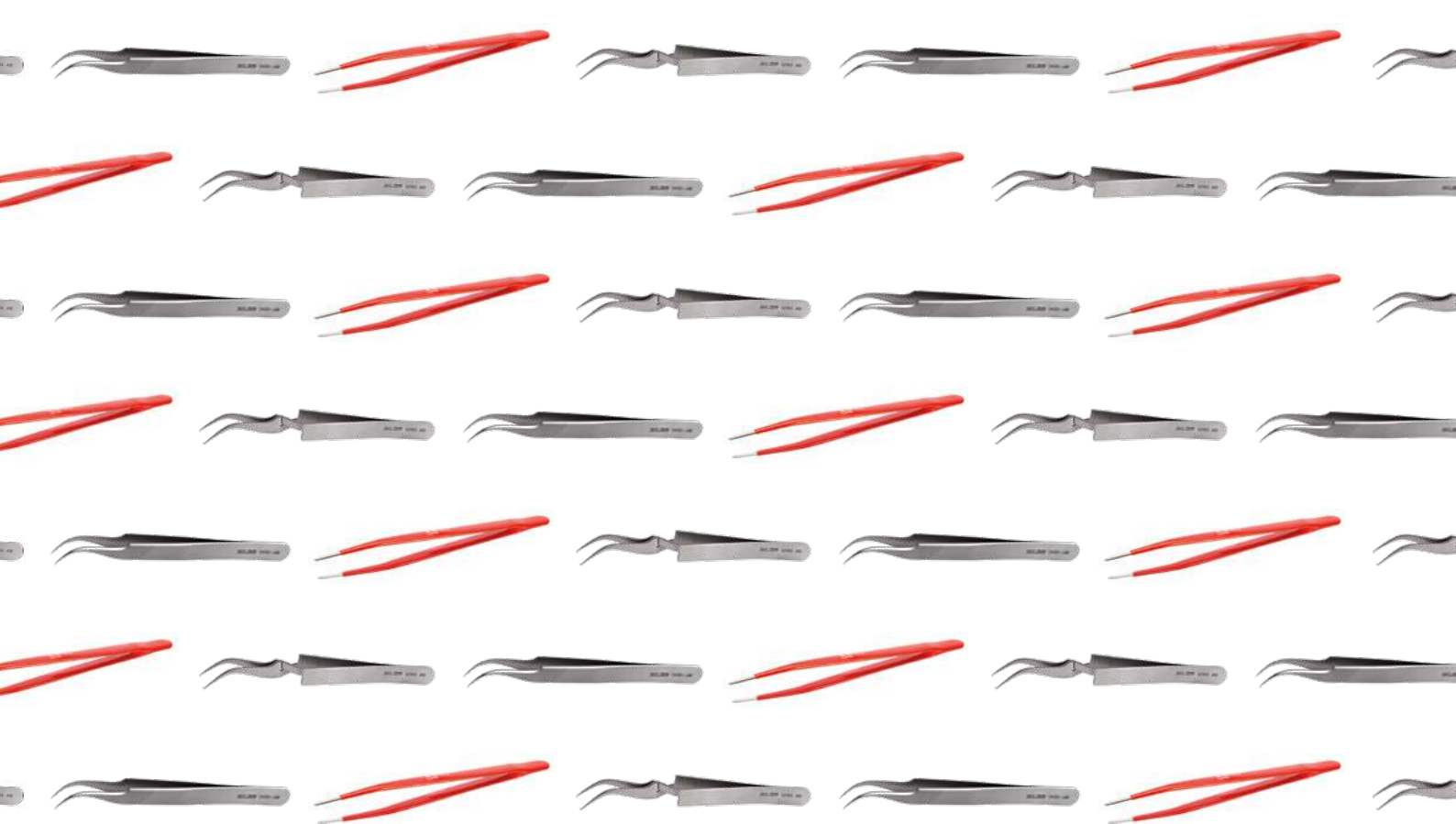

## Pinzas y herramientas especiales para electrónica



## PINZAS ELECTRONICA

Pinza universal



**5468**

L	€		
112 mm	26,84	5	5468-112

Pinza universal



**5469**

L	€		
127 mm	26,08	5	5469-127
127 mm	40,61	5	5469 R
127 mm	29,30	5	5469 I

Pinza universal



**5469B**

L	€		
120 mm	25,19	5	5469 B
120 mm	26,97	5	5469 BI

Pinza universal



**5471F**

L	€		
120 mm	21,54	5	5471 F-120
145 mm	23,34	5	5471 F-145
200 mm	47,39	5	5471 F-200

L	€		
250 mm	60,59	5	5471 F-250
300 mm	83,30	5	5471 F-300
120 mm	22,68	5	5471 FI-120
200 mm	45,62	5	5471 FI-200
120 mm	37,09	5	5471 FR-120
145 mm	42,08	5	5471 FR-145

Pinza College



**5475R/5475K**

L	€		
150 mm	50,95	5	5475 R
100 mm	28,07	5	5475 K

Pinza College



**5516**

L	€		
150 mm	24,75	5	5516
150 mm	27,15	5	5516 I

Pinza anti-magnética



**5465AMT**

L	€		
110 mm	58,67	5	5465 AMT

Pinza de punta puntiaguda



**5517**

L	€		
155 mm	28,61	5	5517
155 mm	28,05	5	5517 I

Pinza con puntas en cruz



**5518**

L	€		
155 mm	31,26	5	5518

Pinza SDM para electrónica



**5540AM**

L	€		
120 mm	43,02	5	5540 AM

Pinza SDM para electrónica



**5541AM**

L	€		
120 mm	43,02	5	5541 AM



Pinza SDM para electrónica



**5544AM**



115 mm

€

43,02



5



5544 AM

Pinza SDM para electrónica



**5549AM**



120 mm

€

43,02



5



5549 AM

Pinza de engastar



**5579**



115 mm

€

46,56



5



5579-115

Pinza SDM para electrónica



**5545AM**



120 mm

€

43,02



5



5545 AM

Pinza para electrónica



**5488AM**



115 mm

€

43,02



5



5488 AM

Pinza SDM para electrónica



**5588AM**



120 mm

€

43,02



5



5588 AM

Pinza SDM para electrónica



**5546AM**



120 mm

€

43,02



5



5546 AM

Pinza para electrónica



**5490AM**



115 mm

€

43,02



5



5490 AM

Pinza SDM para electrónica



**5589AM**



120 mm

€

43,02



5



5589 AM

Pinza SDM para electrónica



**5547AM**



120 mm

€

43,02



5



5547 AM

Pinza de engastar



**5578**



122 mm

€

46,56



5



5578-115

Pinza SDM para electrónica



**5590AM**



120 mm

€

43,02



5



5590 AM



Pinza de relojero



**5463**

L		€		
120 mm		35,05	5	5463-120
120 mm		58,67	5	5463 R

Pinza cortante para electrónica



**5493**

L		€		
115 mm		68,50	5	5493-115

Pinza para soldar



**5476H**

L		€		
160 mm		65,88	5	5476 H

## HERRAMIENTAS DE SOLDADURA

Soldadora



**3250**

W	°C	€		
100 W	400 °C	85,92	1	325001000
		4,82	1	3250010SH

Punta recambio: 3250010SH

Soldadora para trabajos de industria pesada



**322500**

W	°C	€		
30 W	370 °C	45,36	1	322500300
40 W	375 °C	48,07	1	322500500
80 W	380 °C	51,13	1	322500800

Soldador eléctrico, ligero y compacto



**32600**

W	°C	€		
18 W	390 °C	52,79	1	326000200
25 W	420 °C	57,25	1	326000300

Soldador con control de temperatura



**3270**

W	°C	€		
50 W	200-500 °C	109,09	1	327020500

Puntas de repuesto para soldadora



**3225**

	€		
1.5 x 2.5 mm	8,87	1	322510300
2 x 3 mm	8,87	1	322510500
2 x 3 mm	8,87	1	322510600
2.5 x 5 mm	8,87	1	322510700
2.5 x 5 mm	8,87	1	322510800

Puntas de repuesto para soldadora



**326010**

g	€		
5 g	7,71	1	326010200
5 g	7,78	1	326020200
5 g	7,78	1	326030200

Puntas de repuesto para soldador 3270



**327020500-SH**

Diagram	€	Icons
0,5mm	8,26	1 327020500-SH1
2mm	8,26	1 327020500-SH2
3mm	8,26	1 327020500-SH3
4mm	8,26	1 327020500-SH4

Juego de punzones y ganchos largos - 4 piezas



**2633L/**

Diagram	€	Icons
12 x 12 x 275 mm	27,15	12 2633L/S4

Tenedor para desoldar



ergo®



**BE-3529**

Diagram	€	Icons
197 mm	19,47	5 BE-3529

Soldadura libre de plomo (Sn)



**3290**

Diagram	€	Icons
2000 mm	4,66	1 329000330
4000 mm	5,75	1 329000500

Gancho doble para hilos y muelles



**5418**

Diagram	€	Icons
145 mm	48,19	1 5418

Destornillador de ajuste con guía



**5550**

Diagram	€	Icons
140 mm	19,32	10 5550-3.2
140 mm	21,76	10 5550-4.5

**HERRAMIENTAS PARA MECÁNICA DE PRECISIÓN**

Punzones en miniatura, ganchos y picos



**2633/**

Diagram	€	Icons
17 x 80 x 150 mm	26,65	12 2633/S4

Juego de ganchos para hilos y muelles



**5419/6T**

Diagram	€	Icons
5 x 78 x 110 mm	56,34	1 5419/6T

Útiles de sintonización



**5551-5554**

Diagram	€	Icons
205 mm	20,21	1 5552*
195 mm	20,21	1 5553*
180 mm	20,21	1 5554*

\* Hasta agotar existencias



Juego de útiles de sintonización



**5600/4**

<b>g</b>	€		
75 g	94,41	1	5600/4*

5551, 5552, 5553, 5554

Pinza pelacables lacada



**2530-32/2530-40**

	€		
130 mm	48,22	5	2530-40

Rasqueta triangular



**3524**

<b>g</b>	€		
24 g	35,93	1	3524
5 g	17,25	1	3524L-K

Rasqueta triangular



**3525HB**

	€		
168 mm	27,84	5	3525HB

Rasqueta de acero al carbono



**2487**

	€		
210 mm	17,88	12	2487





# Medición y trazado



## FLEXÓMETROS Y CINTAS MÉTRICAS

### Flexómetro



#### MTS

L	mm	€	Icon	Icon	Model
5 m	25 mm	33,46	6		MTS-5-25
5 m	25 mm	33,46	6		MTS-5-25-E
8 m	25 mm	41,33	6		MTS-8-25
8 m	25 mm	41,33	6		MTS-8-25-E

E: Pulgadas

### Flexómetro Bimaterial



#### MTB

L	mm	€	Icon	Icon	Model
3 m	16 mm	12,11	6		MTB-3-16
3 m	16 mm	13,81	6		MTB-3-16-M
3 m	16 mm	13,81	6		MTB-3-16-M-E
5 m	25 mm	24,75	6		MTB-5-25
5 m	25 mm	26,48	6		MTB-5-25-M
5 m	25 mm	26,48	6		MTB-5-25-M-E
8 m	25 mm	37,68	6		MTB-8-25
8 m	25 mm	40,18	6		MTB-8-25-M
8 m	25 mm	40,18	6		MTB-8-25-M-E

M: Punta magnética E: Pulgadas

### Flexómetro clase I



#### MTB\_C1

L	mm	€	Icon	Icon	Model
5 m	25 mm	36,66	6		MTB-5-25-C1

### Flexómetro



#### MTG

L	mm	€	Icon	Icon	Model
3 m	16 mm	5,42	12		MTG-3-16
3 m	16 mm	5,42	12		MTG-3-16-E
5 m	19 mm	8,53	12		MTG-5-19
5 m	19 mm	8,53	12		MTG-5-19-E
8 m	25 mm	10,85	4		MTG-8-25
8 m	25 mm	10,85	4		MTG-8-25-E

E: Pulgadas

### Flexómetro compacto Clase medición I



#### MTC\_C1

L	mm	€	Icon	Icon	Model
3 m	13 mm	11,68	6		MTC-3-13-C1
5 m	16 mm	13,09	6		MTC-5-16-C1

### Flexómetro compacto clase II



#### MTC\_C2

L	mm	€	Icon	Icon	Model
3 m	13 mm	8,39	6		MTC-3-13
5 m	16 mm	10,23	6		MTC-5-16

### Flexómetro compacto de 3m



#### MT-TS-3

L	mm	€	Icon	Icon	Model
3 m	13 mm	10,15	12		MT-TS-3

### Flexómetro



#### 1162N

L	mm	€	Icon	Icon	Model
3 m	13 mm	24,06	1		1162N-1/2

### Cinta métrica de acero con adhesivo



#### BT

L	mm	€	Icon	Icon	Model
3 m	13 mm	7,47	12		BTR-3-13
6 m	13 mm	9,54	12		BTR-6-13
3 m	13 mm	7,47	12		BTL-3-13
6 m	13 mm	9,54	12		BTL-6-13

Cinta métrica



**LTG**

L	T	€		
10 m	10 mm	17,20	6	LTG-10
20 m	10 mm	23,05	6	LTG-20
30 m	10 mm	27,63	6	LTG-30

Cinta métrica



**LTB**

L	T	€		
10 m	13 mm	20,54	6	LTB-10
20 m	13 mm	23,30	6	LTB-20
30 m	13 mm	30,12	6	LTB-30

Cinta métrica larga



**LT-STEEL**

L	T	€		
30 m	13 mm	69,33	5	LT-STEEL-30
50 m	13 mm	108,54	5	LT-STEEL-50

Cinta métrica



**LTS**

L	T	€		
30 m	13 mm	29,12	5	LTS-30
30 m	13 mm	29,12	5	LTS-30-E
50 m	13 mm	40,13	5	LTS-50
50 m	13 mm	40,13	5	LTS-50-E
100 m	13 mm	84,65	5	LTS-100
100 m	13 mm	84,65	5	LTS-100-E

E: Pulgadas

**RUEDAS DE MEDICIÓN**

Rueda de medición, 150 mm



**MW-150**

L	€		
150 mm	78,34	2	MW-150

Rueda de medición, 250 mm



**MW-250**

L	€		
940 mm	140,52	2	MW-250

**NIVELES**

Nivel aluminio con asas



**466**

L	€		
400 mm	33,57	4	466-400
400 mm	42,19	4	466-400-M
600 mm	40,86	4	466-600
600 mm	49,56	4	466-600-M
800 mm	44,32	4	466-800
800 mm	53,56	4	466-800-M
1000 mm	49,55	4	466-1000
1000 mm	61,40	4	466-1000-M
1200 mm	59,99	4	466-1200
1200 mm	73,07	4	466-1200-M
1800 mm	77,36	4	466-1800
2000 mm	94,37	4	466-2000

M: Punta magnética

Nivel



**426**

L	T	€		
400 mm	49x22 mm	32,56	1	426-400
600 mm	49x22 mm	36,72	1	426-600
800 mm	49x22 mm	41,01	1	426-800
1000 mm	49x22 mm	48,68	1	426-1000
1200 mm	49x22 mm	57,26	1	426-1200



Nivel de aluminio ligero



**416**

	€		
400 mm	16,45	10	416-400
600 mm	19,29	10	416-600
800 mm	22,25	10	416-800
1000 mm	27,49	10	416-1000
1200 mm	31,17	10	416-1200
1500 mm	35,23	10	416-1500
1800 mm	40,96	10	416-1800
2000 mm	48,80	10	416-2000

Nivel ligero trapezoidal, aluminio inyectado



**405L**

	€		
400 mm	28,00	10	405L-400
600 mm	34,00	10	405L-600

Nivel magnético sólido, aluminio inyectado



**406\_M**

		€		
300 mm	1	50,33	5	406-300-M
400 mm	1	55,33	5	406-400-M
500 mm	1	60,67	5	406-500-M
600 mm	1	59,47	5	406-600-M

Nivel trapezoidal, aluminio inyectado



**405**

	€		
400 mm	30,65	5	405-400
600 mm	36,66	5	405-600
800 mm	46,65	10	405-800
1000 mm	62,64	5	405-1000

Nivel magnético ligero trapezoidal, aluminio inyectado



**405L\_M**

	€		
400 mm	31,32	5	405L-400-M
600 mm	38,00	5	405L-600-M

Nivel de poliestireno



**406P**

	€		
400 mm	10,51	10	406P-400
600 mm	13,30	10	406P-600

Nivel magnético trapezoidal, aluminio inyectado



**405\_M**

	€		
400 mm	34,54	5	405-400-M
600 mm	40,65	5	405-600-M
800 mm	50,53	5	405-800-M
1000 mm	66,53	5	405-1000-M

Nivel de aluminio inyectado



**406**

	€		
300 mm	36,63	1	406-300
400 mm	41,50	5	406-400
500 mm	50,07	5	406-500
600 mm	49,08	5	406-600
800 mm	58,05	5	406-800

416-SET-1 + Bolsa de transporte



**416-SET+BAG**

	€		
3	104,10	1	416-SET+BAG

416-SET-1

4750-LV-1

BAHCO





Juego de 3 niveles de aluminio



**416-SET-1**



3 € 70,31 5 416-SET-1

416-600, 416-1200, 416-1800



Juego de 3 niveles



**416-SET-2**



3 € 73,25 5 416-SET-2

416-600, 416-1200, 416-2000



Nivel magnético



**406T-225**



228 mm € 7,00 10 406T-225

DISP es un display con 12 unidades

Nivel torpedo de aluminio



**426TOR9**



230 mm € 23,72 10 426TOR9

Nivel de andamio



**466-250**



250 mm € 30,12 10 466-250

Alineador base magnética



**466-LINE**



75 mm € 5,50 12 466-LINE

Nivel dos posiciones



**466-BE1**



20 g 13 x 45 x 60 mm € 6,62 12 466-BE1

Nivelador de postes magnético



**466-POST**



120 x 75 x 80 mm € 9,29 6 466-POST

Nivel de aluminio



**486**



1800 mm € 60,61 5 486-1800  
2000 mm € 66,46 5 486-2000  
2400 mm € 78,00 5 486-2400

Nivel de aluminio



**486-xxxWH**



1800 mm € 60,61 5 486-1800WH  
2000 mm € 66,46 5 486-2000WH  
2400 mm € 78,00 5 486-2400WH

Nivel de doble perfil



**496**



1500 mm € 75,62 5 496-1500  
1800 mm € 88,24 5 496-1800



Vial de repuesto para nivel



**496-SPARE**

	€		
496-1500, 496-1800	7,68	1	496-SPARE

**MARCADO**

Plomada trazadora de magnesio rápida 5:1, 30 m



**CL-1441**

	€		
185 mm	25,00	36	CL-1441

Plomada trazadora de magnesio 1:1



**CL-1331**

	€		
185 mm	19,32	48	CL-1331

Plomada trazadora triple velocidad de rebobinado



**CL-1221**

	€		
130 mm	12,54	6	CL-1221

CL-Line: Línea de trazado de repuesto

Polvo colorante, 227 g



**CHALK**

	€		
227 g	3,18	6	CHALK-BLUE
227 g	3,38	6	CHALK-WHITE
227 g	3,18	6	CHALK-RED
227 g	3,18	6	CHALK-YELLOW

Plomada trazadora CL-14411 + polvo colorante azul



**CL-1441-SET**

	€		
605 g	32,85	16	CL-1441-SET

CL-1441  
CHALK-BLUE

Juego de Plomada trazadora, Polvo colorante azul y Nivel de línea



**CL-1221-SET**

	€		
180 g	18,21	4	CL-1221-SET

CHALK-BLUE

466-LINE

CL-1221

Plomada metálica 5m de cuerda



**PBS**

	€		
5 m	25,37	6	PBS-700

Plomada de latón



**PBB**

		€		
185 mm	227 g	24,82	8	PBB-8

Lapiz Carpintero grado HB



**P-HB**

		€		
175 mm	25	0,79	25	P-HB

Display 200 lápices de carpintero



**PENCIL-200**

		€		
180 mm	200	186,79	1	PENCIL-200-DISP

Portaminas de carpintero, dureza HB



**P-MEC**

		€		
150 mm	1	5,70	24	P-MEC
100 mm	5	4,13	12	P-MEC-LEAD

Punta de trazar con punta de recambio Carbide de 150 mm



**1179-SCRIBE**

	€		
150 mm	22,08	5	1179-SCRIBE
	7,65	1	1179-TIPS

Diam. Punta 2,5mm Diam. Cuerpo 8mm

Punta de trazar de carburo de tungsteno de 150 mm



**1178-SCRIBE**

	€		
150 mm	7,53	5	1178-SCRIBE

Puntas de trazar acodadas, 230 mm



**1177-SCRIBE**

	€		
230 mm	6,73	5	1177-SCRIBE

**REGLAS**

Metro plegable 1m de madera de abedul



**WR1**

		€		
1 m	17 mm	4,80	50	WR1
1 m	17 mm	4,81	50	WR1-MM

WR1: mm y pulg WR1-MM: Métrico

Metro plegable 2m de madera de abedul



**WR2**

		€		
2 m	17 mm	6,40	25	WR2
2 m	17 mm	7,70	25	WR2-MM

WR2:mm y pulg WR2-MM: Métrico

Metro 2m plegable 12 secciones mm



**WR2-12**

		€		
2 m	17 mm	6,40	25	WR2-12

Regla flexible de acero inoxidable con clip bolsillo



**1179-FLX**

		€		
160 mm	12 mm	2,79	25	1179-FLX



Regla de acero, mm



SR\_MM

L	W	€	PK	Code
150 mm	19 mm	2,13	12	SR150-MM
200 mm	19 mm	2,79	12	SR200-MM
300 mm	25 mm	3,75	12	SR300-MM
600 mm	30 mm	7,33	20	SR600-MM
1000 mm	35 mm	15,43	20	SR1000-MM

Producto no disponible para España

Regla de acero, pulgadas



SR\_IN

L	W	€	PK	Code
6 in	6 in	2,13	12	SR150-E
8 in	8 in	2,79	12	SR200-E
12 in	12 in	3,75	12	SR300-E
24 in	24 in	7,33	20	SR600-E
39 in	40 in	15,43	20	SR1000-E

ESCUADRAS

Escuadra



9045-B

L	W	€	PK	Code
220 mm	170 mm	26,32	6	9045-B-200
250 mm	170 mm	27,85	6	9045-B-250
300 mm	170 mm	30,37	6	9045-B-300
400 mm	170 mm	35,42	1	9045-B-400

Escuadra



9048

L	W	€	PK	Code
200 mm	165 mm	21,15	10	9048-200
250 mm	165 mm	21,88	10	9048-250

L	W	€	PK	Code
300 mm	180 mm	24,99	10	9048-300
350 mm	180 mm	25,02	10	9048-350
400 mm	180 mm	26,48	10	9048-400

Escuadra de albañil



3085

L	W	€	PK	Code
400 mm	200 mm	368,36	1	308504000
500 mm	250 mm	21,57	1	308505000
600 mm	300 mm	24,92	1	308506000
800 mm	400 mm	30,31	1	308508000
1000 mm	500 mm	34,03	1	308510000

Escuadra Combinada



CS

L	W	€	PK	Code
152 mm	90 mm	13,13	12	CS150
305 mm	125 mm	24,43	12	CS300
407 mm	125 mm	27,19	12	CS400

Kit de piezas de repuesto para los modelos CS de escuadras deslizantes, 4 piezas



CS-SPARE

Code	€	PK	Code
CS150, CS300, CS400	4,57	1	CS-SPARE

Escuadra ajustable



9572

L	W	€	PK	Code
235 mm	115 mm	26,29	20	9572-200
250 mm	150 mm	27,88	20	9572-250

Escuadra



9574

L	W	€	PK	Code
215 mm	165 mm	21,49	10	9574-200
285 mm	170 mm	22,04	10	9574-250
300 mm	170 mm	23,33	10	9574-300

Escuadra fija



9575

L	W	€	PK	Code
250 mm	110 mm	32,58	6	9575-250



Escuadra de carpintero



**FCS-600/FCS-1000**

L	W	€	Q	Model
600 mm	300 mm	22,34	6	FCS-600
800 mm	300 mm	23,73	6	FCS-800
1000 mm	360 mm	25,98	6	FCS-1000

Escuadra ajustable para yesista



**AS-1200**

L	W	€	Q	Model
1265 mm	560 mm	67,92	3	AS-1200

**MEDICIÓN DE PRECISIÓN**

Calibre digital de acero inox



**1150D**

L	W	€	Q	Model
150 mm	25 x 90 x 245 mm	74,25	1	1150D

Rango de 0 - 150 mm en incrementos de 0.01

Calibre pie de rey



**1150**

L	W	€	Q	Model
150 mm	9 x 75 x 235 mm	61,05	1	1150-1/2H/P

Juego de 26 galgas de espesores



**1544**

Q	L	€	Q	Model
26	100 mm	17,54	1	1544

0,03 mm to 0,1 mm in 0,01 mm increments / 0,10 mm to 1,0 mm in 0,05 mm increments

Juego de 13 galgas de espesores



**1546**

L	€	Q	Model
100 mm	10,39	1	1546

Juego de 20 galgas de espesores



**1547**

Q	L	€	Q	Model
20	100 mm	14,30	20	1547

Galgas de roscas 24 hojas 60°



**1535**

Q	L	€	Q	Model
24	67 mm	9,43	1	1535

Galgas de roscas de 52 hojas métrico y whitworth 55°



**1537**

Q	L	€	Q	Model
0.25-6.0 / 4-62	70 mm	14,80	1	1537





**BAHCO®**



## Herramientas para pared



## RASCADORES

Rasqueta ergonómica con funda



ergo®



**625**

g	€	Icon 1	Icon 2
25 mm	31,00	5	625

Hojas de repuesto para rasquetas ERGO™ 625



**449**

g	€	Icon 1	Icon 2
25 mm	13,70	10	449

Hojas para rasqueta 625



**625-**

g	€	Icon 1	Icon 2
3 g	13,70	10	625-DROP
3 g	13,70	10	625-PEAR
3 g	13,70	10	625-ROUND

Rasqueta ergonómica



ergo®



**650**

g	€	Icon 1	Icon 2
50 mm	30,30	5	650

Hojas de repuesto para rasquetas ERGO™ 625



**442**

g	€	Icon 1	Icon 2
50 mm	23,54	10	442-3P
50 mm	14,52	10	442

Hoja de rasqueta para pintura



**850 / 865**

g	€	Icon 1	Icon 2
50 mm	18,12	10	850-1
65 mm	19,98	10	865-1

Rasqueta ergonómica



ergo®



**665**

g	€	Icon 1	Icon 2
65 mm	43,87	5	665

Hojas de repuesto para rasquetas ERGO™ 665



**451**

g	€	Icon 1	Icon 2
65 mm	15,99	10	451

Juego de rasquetas



ergo®



**SCRAPER-SET2**

g	€	Icon 1	Icon 2
50 x 145 x 265 mm	111,25	1	SCRAPER-SET2

625

625-DROP, 625-PEAR, 625-ROUND

650





Rasqueta de carpintero



**474**

← L →	€		
130 mm	<b>10,16</b>	10	474-125-0.60
130 mm	<b>10,31</b>	10	474-125-0.80
150 mm	<b>10,66</b>	10	474-150-0.60
150 mm	<b>10,84</b>	10	474-150-0.80

Espátula con mango de madera riveteado



**2155**

	← L →	€		
30 mm	195 mm	<b>7,64</b>	12	215500300
40 mm	195 mm	<b>8,31</b>	12	215500400
50 mm	195 mm	<b>8,53</b>	12	215500500
60 mm	215 mm	<b>8,69</b>	12	215500600
70 mm	220 mm	<b>8,90</b>	12	215500700
80 mm	225 mm	<b>9,31</b>	12	215500800
90 mm	230 mm	<b>9,51</b>	12	215500900
100 mm	234 mm	<b>9,92</b>	12	215501000

Espátula Mango de Plástico de Acero al Carbono con virola



**216**

	← L →	€		
30 mm	210 mm	<b>3,96</b>	12	216000300
40 mm	210 mm	<b>4,07</b>	12	216000400
50 mm	210 mm	<b>4,27</b>	12	216000500
60 mm	210 mm	<b>4,39</b>	12	216000600
70 mm	210 mm	<b>4,73</b>	12	216000700
80 mm	210 mm	<b>4,96</b>	12	216000800
90 mm	228 mm	<b>5,24</b>	12	216000900
100 mm	230 mm	<b>6,02</b>	12	216001000
120 mm	230 mm	<b>7,05</b>	12	216001200

Espátula de Acero al Carbono Mango Bi Material



**2150**

	← L →	€		
30 mm	225 mm	<b>4,66</b>	12	215000030
40 mm	225 mm	<b>4,83</b>	12	215000040
50 mm	225 mm	<b>5,02</b>	12	215000050
60 mm	225 mm	<b>5,15</b>	12	215000060
70 mm	225 mm	<b>5,55</b>	12	215000070
80 mm	225 mm	<b>5,87</b>	12	215000080
90 mm	220 mm	<b>6,32</b>	12	215000090
100 mm	220 mm	<b>7,10</b>	12	215000100
120 mm	220 mm	<b>8,70</b>	12	215000120

Espátula Mango Bimaterial - Hoja Inox



**2161**

	← L →	€		
40 mm	215 mm	<b>8,60</b>	12	216100040
60 mm	215 mm	<b>10,08</b>	12	216100060
80 mm	215 mm	<b>11,33</b>	12	216100080
100 mm	235 mm	<b>11,99</b>	12	216100100
120 mm	235 mm	<b>12,96</b>	12	216100120

Espátula Rígida Mango de Plástico de Acero al carbono



**2165**

	← L →	€		
30 mm	180 mm	<b>7,54</b>	12	216500300
50 mm	180 mm	<b>7,98</b>	12	216500500
75 mm	200 mm	<b>10,08</b>	12	216500750
100 mm	200 mm	<b>11,33</b>	12	216501000

Espátula de emplastecer



**2190**

	← L →	€		
100 mm	235 mm	<b>6,78</b>	5	219001000
120 mm	230 mm	<b>7,50</b>	5	219001200
140 mm	245 mm	<b>8,38</b>	5	219001400
160 mm	235 mm	<b>9,13</b>	5	219001600
200 mm	245 mm	<b>11,98</b>	5	219002000

Espátula de emplastecer inoxidable



**2192**

	← L →	€		
100 mm	235 mm	<b>10,98</b>	5	219201000
120 mm	230 mm	<b>12,02</b>	5	219201200
140 mm	235 mm	<b>14,75</b>	5	219201400
160 mm	245 mm	<b>16,36</b>	5	219201600
200 mm	235 mm	<b>20,54</b>	5	219202000

Espátula de emplastecer inoxidable



**2193**

← L →	€		
250 mm	<b>19,26</b>	10	219302500
300 mm	<b>20,67</b>	10	219303000
350 mm	<b>22,05</b>	10	219303500



Espátula de encolar

**2212**

		€			
130 mm	120 mm	5,67	5		221201200
130 mm	200 mm	6,91	5		221202000
130 mm	300 mm	10,09	5		221203000

Espátula

**2489**

	€			
235 mm	24,30	12		2489

Llana dentada

**209**

		€			
270 mm	115 mm	16,69	12		209027040

**HERRAMIENTAS PARA ALBAÑILERÍA**

Espátula de encolar

**2213**

		€			
130 mm	120 mm	5,67	5		221301200
130 mm	200 mm	6,73	5		221302000
130 mm	300 mm	10,09	5		221303000

Paletín punta aguda

**2308**

		€			
150 mm	100 mm	19,95	6		2308B0000*

Llana dentada

**2092**

		€			
275 mm	115 mm	16,20	12		209227060
280 mm	130 mm	17,12	12		209228100
500 mm	130 mm	29,00	6		209250100

Cuchillo curvo

**2488**

	€			
230 mm	19,77	12		2488

Llana - Rectangular

**204**

		€			
300 mm	150 mm	16,05	12		204030150
300 mm	160 mm	17,12	12		204030160
300 mm	180 mm	18,04	12		204030180

Llana de Acero Inoxidable

**2045**

		€			
300 mm	140 mm	19,14	12		204530140
500 mm	130 mm	29,44	6		204550130

2045A3000: Hoja afilada

Llana de acero inoxidable para emplastecer



**2045A**

Icon 1	Icon 2	€	Icon 3	Icon 4
140 mm	300 mm	20,86	12	2045A3000

Talocha de Plástico con Punta



**213**

Icon 1	Icon 2	€	Icon 3	Icon 4
265 mm	140 mm	5,29	5	213026140

Carril cuchillas rectas sin dentar



**2145xxxL**

Icon 1	€	Icon 2	Icon 3
45 x 20 x 275 mm	13,41	1	2145020L0
45 x 25 x 275 mm	13,55	1	2145025L0
45 x 30 x 275 mm	13,73	1	2145030L0
45 x 35 x 275 mm	14,00	1	2145035L0

Llana de Plástico Plana



**211**

Icon 1	Icon 2	€	Icon 3	Icon 4
350 mm	180 mm	8,26	5	211035180
420 mm	210 mm	10,80	5	211042210

Guión Yesero de Aluminio



**2127**

Icon 1	Icon 2	€	Icon 3	Icon 4
90 mm	435 mm	42,91	6	212704350

Carril cuchillas curvas sin dentar



**2145xxxC**

Icon 1	€	Icon 2	Icon 3
45 x 25 x 225 mm	14,00	1	2145025C0
45 x 35 x 210 mm	14,35	1	2145039C0

Talocha de Plástico base estriada



**2120**

Icon 1	Icon 2	€	Icon 3	Icon 4
270 mm	180 mm	6,39	5	212027180
330 mm	220 mm	6,92	8	212033220

Carril cuchillas dentadas y rectas



**2145xxxD**

Icon 1	€	Icon 2	Icon 3
45 x 20 x 275 mm	13,41	1	2145020D0
45 x 25 x 275 mm	13,55	1	2145025D0
45 x 30 x 275 mm	13,73	1	2145030D0
45 x 35 x 275 mm	14,00	1	2145035D0

Talocha para Soladores



**2122**

Icon 1	Icon 2	€	Icon 3	Icon 4
250 mm	100 mm	21,60	10	212202500

\* Hasta agotar existencias



Talocha Esponja



**2123**

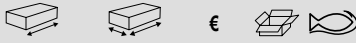

140 mm 280 mm € 16,07 10 212302900

Talocha Goma Dura



**2125**

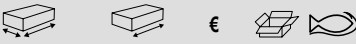

220 mm 135 mm € 12,96 10 212502150

Talocha Goma Blya



**2126**

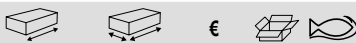

140 mm 220 mm € 15,19 10 212602150  
140 mm 280 mm € 19,91 1 212602800

**HERRAMIENTAS PARA PAREDES DE PLACAS DE ESCAYOLA**

Set de repuestos elevación (2muelles+freno)



**250400010**

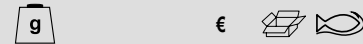

80 g € 42,11 1 250400010

Repuesto para elevador (cable)



**250400020**

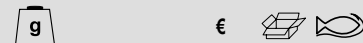

180 g € 74,27 1 250400020

Repuesto para elevador (mango antena)



**250400030**



80 g € 139,53 1 250400030

Pinza especial para colgar tacos metalicos en materiales huecos



**250501800**



185 mm € 67,85 50 250501800

Tijera para ingleses



**8640**



230 mm € 68,33 50 864002450

Hoja de repuesto para 8640



**864000010**



20 g € 21,01 1 864000010



Inglete de repuesto para 864



**864000020**

	€		
20 g	11,98	1	864000020

Pinza para unir perfiles sin remache



**671002600**

	€		
260 mm	153,13	50	671002600*

Tijera para Ingletes



**8641**

	€		
245 mm	65,63	1	864102400

Pinza para unir perfiles sin remache



**671002850**

	€		
295 mm	116,98	1	671002850*

Hoja de repuesto para 8641



**864100010**

	€		
5 g	12,08	1	864100010

\* Hasta agotar existencias





**BAHCO®**



## Arcos de sierra manuales



## ARCOS DE SIERRA

Arco de sierra para metales - profesional



ergo



**325**

	€		
300 mm	49,68	5	325

Arco de sierra para metales - profesional



**225-PLUS**

	€		
300 mm	32,01	5	225-PLUS

Arco de sierra para metales - profesional



**319**

	€		
300 mm	27,72	5	319

Arco de sierra para metales - compacto



**317**

	€		
432 mm	20,09	10	317

Arco de sierra para metales - compacto



**306**

	€		
440 mm	15,59	10	306

Arco de sierra tradicional



**320**

	€		
504 mm	23,07	10	320

Arco de sierra



**304**

	€		
517 mm	8,13	10	304

Mini arco de sierra para metales



**208**

	€		
330 mm	17,03	5	208

Hoja Sandflex® para sierra compás



**321**

	€		
330 g	36,71	5	321

Sierra universal con doble hoja 300mm/12"



**210**

	€		
360 g	32,75	10	210

Mini arco para metal



**268**

	€		
150 mm	13,58	5	268

Mini arco para metal



**239**

	€		
260 mm	5,98	150	239

Mini arco para metal



**238**

	€		
150 mm	12,06	60	238

Mini arco para metal



**228**

	€		
150 mm	11,83	80	228
150 mm	10,77	5	228-BULK

Mini arco para metal



**219**

	€		
291 mm	5,56	120	219

Mini arco para metal



**218**

	€		
235 mm	4,26	10	218
235 mm	2,97	150	218-BULK

HOJAS DE ARCOS DE SIERRA

Hoja Spiro Sandflex® Bi-metal



**3806-SPIRO**

		€		
600 mm	32	26,94	10	3806-600-32

Hoja de sierra de mano - para metal



**3906**

		€		
250 mm	18	1,99	100	3906-250-18-100
250 mm	24	1,99	100	3906-250-24-100
250 mm	32	1,99	100	3906-250-32-100
300 mm	14	2,24	100	3906-300-14-100
300 mm	18	2,24	100	3906-300-18-100
300 mm	24	2,24	100	3906-300-24-100
300 mm	32	2,24	100	3906-300-32-100
300 mm	18-28	2,37	100	3818-300-PROG-100
300 mm	14	34,88	10	3906-300-14-10P
300 mm	18	22,33	10	3906-300-18-10P
300 mm	24	28,42	10	3906-300-24-10P
300 mm	32	28,42	10	3906-300-32-10P
250 mm	18	10,48	10	3906-250-18-5P
250 mm	24	10,48	10	3906-250-24-5P
250 mm	32	10,48	10	3906-250-32-5P
300 mm	14	11,79	10	3906-300-14-5P
300 mm	18	14,47	10	3906-300-18-5P
300 mm	24	14,47	10	3906-300-24-5P
300 mm	32	14,47	10	3906-300-32-5P
300 mm	18-28	14,87	10	3818-300-PROG-5P
300 mm	18/24/32	8,96	10	3906-300-3P
300 mm	18	6,17	10	3906-300-18-2P
300 mm	24	6,17	10	3906-300-24-2P
300 mm	32	6,17	10	3906-300-32-2P





Hoja de sierra de mano, acero rápido



**3905**

L	T	€	Icon	Icon	Code
250 mm	24	2,27	100		3905-250-24-100
300 mm	14	2,37	100		3905-300-14-100
300 mm	18	2,37	100		3905-300-18-100
300 mm	24	2,37	100		3905-300-24-100
300 mm	32	2,21	100		3905-300-32-100
300 mm	24	6,17	10		3905-300-24-2P

Hoja de repuesto para mini-arcos de sierra

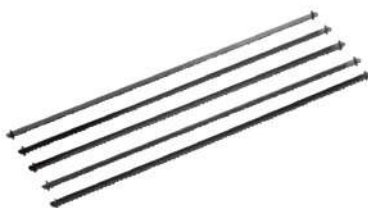

**228-P**

L	T	€	Icon	Icon	Code
150 mm	15	4,26	10		228-15-5P
150 mm	32	4,26	10		228-32-5P
150 mm	32	5,05	10		228-32-10P
150 mm	32	29,54	1		228-32-100P

Hoja con dentado de carburo de tungsteno



**3816**

L	T	€	Icon	Icon	Code
300 mm	12	13,21	50		3816-300

Hoja recubierta de carburo de tungsteno



**216-R**

L	T	€	Icon	Icon	Code
150 mm	20	7,23	1		216-150-R
300 mm	20	10,65	1		216-300-R

Hoja de recambio para mini arco



**215**

L	T	€	Icon	Icon	Code
150 mm	110	7,23	1		215-150

Hoja Sandflex® intercambiable para sierra calar 321



**321-SB**

L	T	€	Icon	Icon	Code
310 mm	7	18,34	10		321-7-SB
310 mm	18	19,56	10		321-18-SB
310 mm	24	19,88	10		321-24-SB



## Serruchos



## SERRUCHOS PARA MATERIALES DE CONSTRUCCION

Serrucho universal



**PC-GNP**

		€		
375 mm	15/16	29,36	4	PC-15-GNP

Hoja de serrucho Superior para uso general



**EX-16-GNP-C**

		€		
400 mm	15/16	33,07	10	EX-16-GNP-C

Serrucho de calar superior



**3150**

		€		
300 mm	9/10	36,73	4	3150-12-XT9-HP

Serrucho de calar



**NP-COM**

		€		
300 mm	7/8	15,87	4	NP-12-COM

Serrucho de calar - diente templado



**PC-COM**

		€		
300 mm	9/10	22,22	4	PC-12-COM

Serrucho para placas de escayola



**PC-6-DRY**

		€		
160 mm	8	23,64	6	PC-6-DRY

Serrucho para yeso



**PC-PLS**

		€		
600 mm	7/8	38,04	4	PC-24-PLS

Hoja de serrucho Superior para escayola



**EX-22-PLS-C**

		€		
550 mm	7/8	41,55	10	EX-22-PLS-C

Serrucho para serrar todo tipo de plásticos



**PC-22-PLC**

		€		
550 mm	11/12	32,11	4	PC-22-PLC

Serrucho para poliestireno



**PC-DECO**

		€		
400 mm	18/19	<b>29,36</b>	4	PC-16-DECO



Serrucho para bloque de hormigón celular



**256**

		€		
650 mm	2	<b>71,47</b>	4	256-26



Serrucho universal



**300**

		€		
350 mm	15/16	<b>20,62</b>	4	300-14-F15/16-HP



Arco de metales para cemento poroso y bloques LEKA



**255-34**

		€		
620 mm	1,3	<b>66,79</b>	2	255-34



Serrucho para material aislante



**PC-22-INS**

		€		
550 mm	WT	<b>31,95</b>	4	PC-22-INS



Serrucho multiuso



**369**

		€		
360 mm	13/14	<b>20,14</b>	20	369-BLADE



Arco de sierra para cemento poroso y bloques LEKA



**255-17/34**

		€		
620 mm	0.6	<b>58,55</b>	2	255-17/34



Serrucho plegable aislante



**396-INS**

		€		
190 mm	WT	<b>26,74</b>	10	396-INS



Serrucho - diente templado



**NP**

		€		
400 mm	7/8	<b>14,96</b>	4	NP-16-U7/8-HP
475 mm	7/8	<b>14,96</b>	10	NP-19-U7/8-HP
550 mm	7/8	<b>15,98</b>	10	NP-22-U7/8-HP



**SERRUCHOS PARA MADERA**



Prizecut + hoja BHS



**EX-NPP-22**

		€		
550 mm	7/8	19,47	10	EX-NPP-22

Hoja PrizeCut BHS



**EX-22-U7**

		€		
550 mm	7/8	15,95	10	EX-22-U7

Serrucho superior para caja de herramientas



ergo®



**2600-16**

		€		
400 mm	11/12	58,28	4	2600-16-XT11-HP

Hoja de serrucho Superior Media



**EX-XT9**

		€		
475 mm	9/10	43,98	10	EX-19-XT9-C
550 mm	9/10	45,52	10	EX-22-XT9-C

Serrucho - diente templado



**PC-GT7**

		€		
475 mm	7/8	30,03	4	PC-19-GT7
550 mm	7/8	31,39	4	PC-22-GT7

Serrucho de costilla superior



ergo®



**3180**

		€		
350 mm	11/12	51,71	4	3180-14-XT11-HP

Sierra de mano - corte transversal



**NP-FLEEM**

		€		
550 mm	7	16,30	10	NP-22-F7/8-HP

Serrucho - reafilable



**PC-FILE**

		€		
400 mm	7/8	19,92	4	PC-16-FILE-U7
475 mm	7/8	21,30	4	PC-19-FILE-U7
550 mm	7/8	22,66	4	PC-22-FILE-U7
600 mm	7/8	32,40	4	PC-24-FILE-U7

Serrucho de ranurar superior



ergo®



**3240**

		€		
350 mm	11/12	43,61	4	3240-14-XT11-HP



Serrucho - diente templado



ergo



2600

Icon	Icon	€	Icon	Icon
475 mm	9/10	60,51	4	2600-19-XT-HP
550 mm	9/10	62,37	4	2600-22-XT-HP



Serrucho para el aserrado de madera tamaño medio a grueso



244

Icon	Icon	€	Icon	Icon
500 mm	7/8	25,17	10	244-20-U7/8-HP
550 mm	7/8	26,18	10	244-22-U7/8-HP



Hoja de serrucho Superior Fina



EX-20-XT11-C

Icon	Icon	€	Icon	Icon
500 mm	11/12	45,52	10	EX-20-XT11-C



Serrucho - diente templado



2500 XT

Icon	Icon	€	Icon	Icon
400 mm	11/12	45,52	4	2500-16-XT-HP
475 mm	9/10	46,92	4	2500-19-XT-HP
550 mm	9/10	48,29	4	2500-22-XT-HP
600 mm	7/8	50,18	4	2500-24-XT7-HP



Hoja de serrucho Superior laminator



EX-20-LAM-C

Icon	Icon	€	Icon	Icon
500 mm	11/12	46,48	10	EX-20-LAM-C



Hoja de serrucho de costilla Superior



EX-14-TEN-C

Icon	Icon	€	Icon	Icon
350 mm	11/12	37,72	5	EX-14-TEN-C



Serrucho Laminator



PC-LAM

Icon	Icon	€	Icon	Icon
500 mm	11/12	32,78	4	PC-20-LAM



Serrucho superior



ergo



3090

Icon	Icon	€	Icon	Icon
500 mm	11/12	57,15	4	3090-20-XT11-HP



Serrucho superior para laminados



SUP-LAM

Icon	Icon	€	Icon	Icon
500 mm	11/12	58,35	4	SUP-20-LAM



Hoja de serrucho Superior para ranurar



EX-14-VEN-C

Icon	Icon	€	Icon	Icon
350 mm	11/12	31,75	10	EX-14-VEN-C



Serrucho - diente templado



**PC-GT9**

Longitud	Dientes	Peso (kg)	Paquetes	Modelo
475 mm	9/10	30,03	4	PC-19-GT9
550 mm	9/10	31,39	4	PC-22-GT9

Serrucho de ranurar - diente templado



**PC-VEN**

Longitud	Dientes	Peso (kg)	Paquetes	Modelo
300 mm	11/12	34,62	4	PC-12-VEN

Serrucho de costilla



**NP-VEN**

Longitud	Dientes	Peso (kg)	Paquetes	Modelo
300 mm	13/14	19,49	10	NP-12-VEN

Serrucho para caja de herramientas - diente templado



**PC-TBX**

Longitud	Dientes	Peso (kg)	Paquetes	Modelo
375 mm	11/12	28,31	4	PC-15-TBX

Serrucho de precisión



**PC-PRC**

Longitud	Dientes	Peso (kg)	Paquetes	Modelo
500 mm	9/10	49,64	4	PC-20-PRC

Hoja de serrucho Superior gruesa



**EX-XT7**

Longitud	Dientes	Peso (kg)	Paquetes	Modelo
550 mm	7/8	45,52	10	EX-22-XT7-C
600 mm	7/8	47,12	10	EX-24-XT7-C

Serrucho de costilla - diente templado



**PC-TEN**

Longitud	Dientes	Peso (kg)	Paquetes	Modelo
300 mm	11/12	32,00	4	PC-12-TEN

Serrucho de costilla



**NP-TEN**

Longitud	Dientes	Peso (kg)	Paquetes	Modelo
300 mm	13/14	18,63	10	NP-12-TEN

Hoja Barracuda BHS



**EX-244P-22**

Longitud	Dientes	Peso (kg)	Paquetes	Modelo
550 mm	7/8	23,78	10	EX-244P-22

Serrucho para el aserrado de madera de tamaño medio a grueso



**244P**

Longitud	Teeth	€	Pack	Model
500 mm	7/8	28,31	4	244P-20-U7-HP
550 mm	7/8	29,41	10	244P-22-U7-HP



Ingletes en madera maciza



**233**

Dimensions	€	Pack	Model
65 x 135 x 300 mm	19,44	5	233-300
75 x 135 x 300 mm	26,64	5	233-300-A
65 x 135 x 400 mm	28,34	5	233-400



**SERRUCHOS DE PRECISIÓN**

Serrucho de ranurar para carpintería



**PC-12-PS**

Longitud	Teeth	€	Pack	Model
305 mm	13.5	42,83	4	PC-12-14-PS
305 mm	13.5	29,87	10	PC-12-14-PS-B



PC-12-14-PS-B: Hoja de recambio

Serrucho superior



ergo



**2700**

Longitud	Teeth	€	Pack	Model
550 mm	7/8	63,56	4	2700-22-XT7-HP
600 mm	7/8	64,48	4	2700-24-XT7-HP



Ingletes en madera laminada



**234-W**

Dimensions	€	Pack	Model
53 x 77 x 245 mm	8,98	10	234-W1
63 x 95 x 300 mm	11,19	10	234-W2
80 x 100 x 300 mm	14,46	10	234-W3



Serrucho de ranurar para cortes extra finos de precisión



**PC-11-PS**

Longitud	Teeth	€	Pack	Model
270 mm	18.5	47,25	4	PC-11-19-PS
270 mm	18.5	32,25	10	PC-11-19-PS-B



PC-11-19-PS-B Hoja de recambio

Serrucho para aglomerados



**PC-TIM**

Longitud	Teeth	€	Pack	Model
600 mm	3.5/4.5	51,17	4	PC-24-TIM



Ingletes en aluminio



**234-A**

Dimensions	€	Pack	Model
55 x 65 x 245 mm	21,14	1	234-A1
40 x 106 x 245 mm	22,32	1	234-A2



Sierra de doble filo corte fino



**PC-9-PS**

Longitud	Teeth	€	Pack	Model
240 mm	6-8.5 / 17	43,41	4	PC-9-9/17-PS
240 mm	6-8.5 / 17	32,53	10	PC-9-9/17-PS-B



Serrucho de ebanista - mango recto



**PC-DTF**

		€		
250 mm	15/16	28,28	10	PC-10-DTF



Serrucho de ebanista - mango recto



**PC-DTR**

		€		
250 mm	15/16	18,50	10	PC-10-DTR



Serrucho de ebanista - mango angulado



**PC-DTL**

		€		
250 mm	15/16	18,50	10	PC-10-DTL



## MANGOS Y AFILADORES

Mango de serrucho ERGO™ para hojas intercambiables



ergo®



**EX-**

	€		
120 x 330 x 60 mm	40,75	4	EX-LL
120 x 330 x 60 mm	40,75	4	EX-RM
120 x 330 x 60 mm	40,75	4	EX-RL



L: Zurdos; R: Diestros

Afilador Para Serrucho Material Aislante HSS



**SHARP-INS**

	€		
206 mm	11,12	100	SHARP-INS



## HOJAS Y ARCOS DE MARQUETERÍA

Arco de marquetería



**502**

	€		
130 mm	10,33	25	502



Juegos de arcos de marquetería, 2 unidades



**502-SET2**

		€		
2	130 g	5,99	35	502-SET2



Juegos de arcos de marquetería, 6 unidades



**502-SET6**

		€		
6	500 g	26,84	10	502-SET6



Juego de hojas para mini-arco



**302-6X4P**



L	€	Icon	Icon
130 mm	10,31	1	302-6X4P

Hoja de repuesto para arcos de marquetería 302 y 502



**302W**



Icon	L	€	Icon	Icon
1	130 mm	3,23	1	302-51W-12P
3	130 mm	3,23	1	302-53W-12P
5	130 mm	3,23	1	302-55W-12P
7	130 mm	3,82	1	302-57W-12P
9	130 mm	4,34	1	302-59W-12P
11	130 mm	4,70	1	302-511W-12P

**SERRUCHO "MUSICAL"**

Serrucho musical



**296**

Icon	€	Icon	Icon
750 mm	155,86	1	296

Hoja repuesto para arcos 202, y 502



**302M**



Icon	L	€	Icon	Icon
1	130 mm	5,38	1	302-71M-12P
3	130 mm	5,39	1	302-73M-12P
5	130 mm	6,48	1	302-75M-12P
7	130 mm	7,00	1	302-77M-12P

**ARCOS Y HOJAS PARA RECORTE**

Mini-arco para recorte



**301**



Icon	€	Icon	Icon
165 mm	19,37	50	301

12 Hojas de repuesto - madera/plástico:  
1: fina



**302S**



Icon	L	€	Icon	Icon
1	130 mm	4,57	1	302-81S-12P
3	130 mm	4,57	1	302-83S-12P
5	130 mm	5,17	1	302-85S-12P

5 hojas de repuesto para mini-arco 301

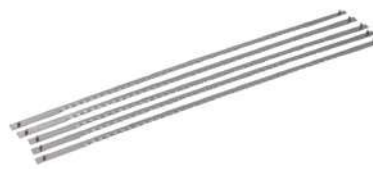

**303**



Icon	€	Icon	Icon
165 mm	5,20	10	303-5P





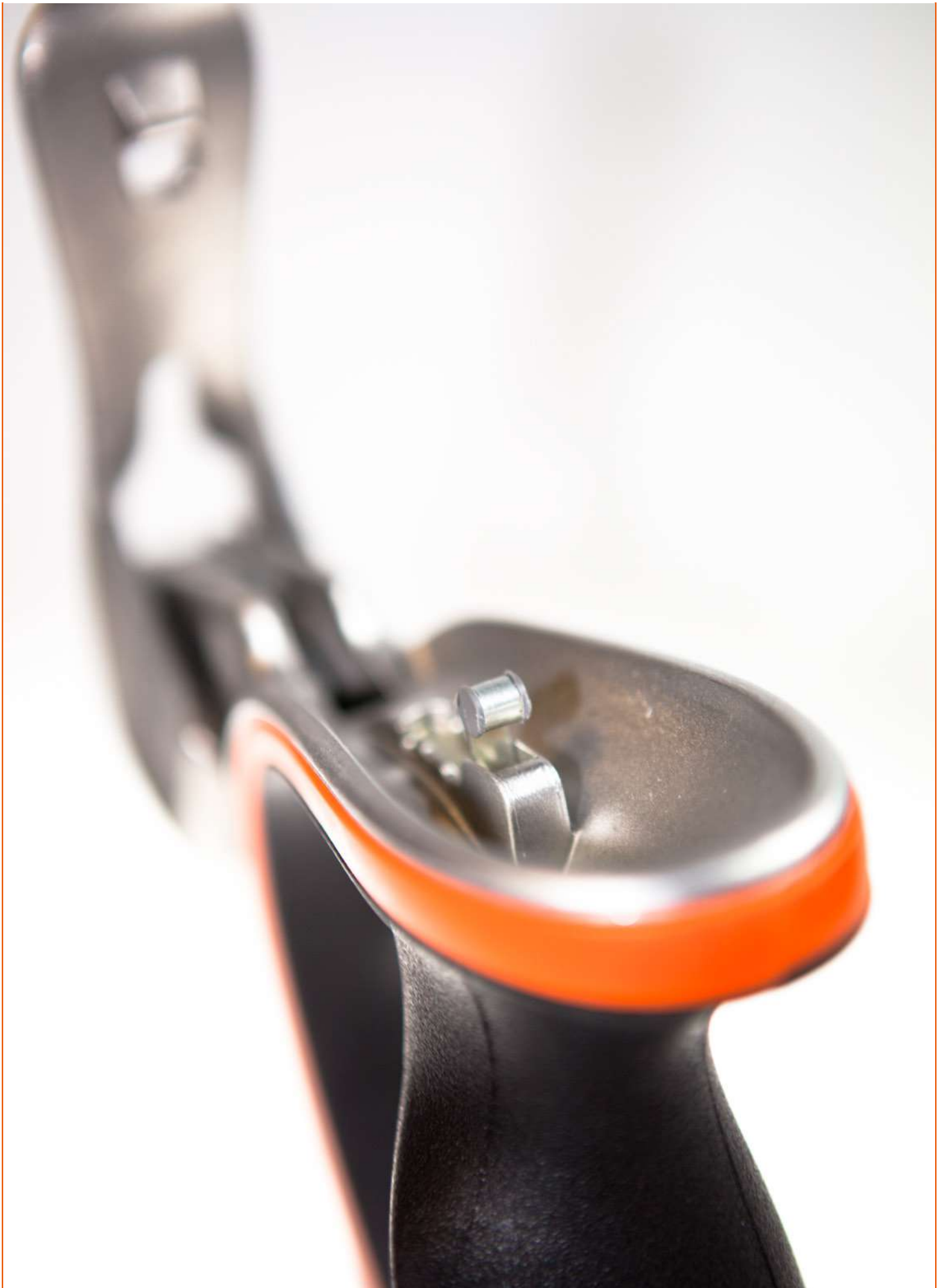

**BAHCO®**



## Formones



## FORMONES

Formón Ergo™



ergo



**434**

	€		
6 mm	23,53	4	434-6
8 mm	24,27	4	434-8
10 mm	24,66	4	434-10
12 mm	25,25	4	434-12
14 mm	25,83	4	434-14
15 mm	26,10	4	434-15
16 mm	26,54	4	434-16
18 mm	26,98	4	434-18
20 mm	27,53	4	434-20
22 mm	28,25	4	434-22
25 mm	28,97	4	434-25
28 mm	30,01	4	434-28
30 mm	30,45	4	434-30
32 mm	31,02	4	434-32
35 mm	31,87	4	434-35
38 mm	32,89	4	434-38
50 mm	37,75	4	434-50

Adecuado para un uso intensivo con martillo metálico

Juego de 3 formones Ergo™ en caja de cartón



ergo



**434-S3-EUR**

	€		
3	81,21	1	434-S3-EUR

Adecuado para un uso intensivo con martillo metálico

434-12, 434-18, 434-25

Juego de 6 formones ERGO™ en bolsa de cuero



ergo



**434-S6-LR**

	€		
6	181,00	1	434-S6-LR

434-6, 434-10, 434-12, 434-18, 434-25, 434-32

Juego de 6 formones Ergo™ en caja de madera



ergo



**434-S6-EUR**

	€		
6	160,69	1	434-S6-EUR

Adecuado para un uso intensivo con martillo metálico

434-6, 434-10, 434-12, 434-18, 434-25, 434-32

Juego de 8 formones Ergo™ en caja de madera



ergo



**434-S8-EUR**

	€		
8	183,53	1	434-S8-EUR

Adecuado para un uso intensivo con martillo metálico

434-6, 434-10, 434-12, 434-16, 434-18, 434-25, 434-32, 434-38

Juego de 6 formones Ergo™ en bolsa de poliéster



ergo



**434-S6-PP**

	€		
6	162,79	1	434-S6-PP

Adecuado para un uso intensivo con martillo metálico

434-6, 434-10, 434-12, 434-18, 434-25, 434-32

Formón profesional con mango bi-componente



**424P**

	€		
4 mm	18,28	4	424P-4
6 mm	18,75	4	424P-6
8 mm	19,21	4	424P-8
10 mm	19,67	4	424P-10
12 mm	20,14	4	424P-12
14 mm	20,61	4	424P-14
15 mm	20,83	4	424P-15
16 mm	21,07	4	424P-16
18 mm	21,54	4	424P-18
20 mm	22,00	4	424P-20
22 mm	22,45	4	424P-22
24 mm	22,93	4	424P-24
25 mm	23,13	4	424P-25
26 mm	23,39	4	424P-26
28 mm	23,87	4	424P-28
30 mm	24,33	4	424P-30
32 mm	24,78	4	424P-32
35 mm	25,48	4	424P-35
38 mm	26,18	4	424P-38
40 mm	26,65	4	424P-40

Juego de 3 formones con mango bi-material en caja de cartón



**424P-S3-EUR**

	€		
3	64,84	1	424P-S3-EUR

424P-12, 424P-18, 424P-25

Juego de 6 cinceles Professional en bolsa de cuero



**424P-S6-LR**

	€		
6	141,79	1	424P-S6-LR

424P-6, 424P-10, 424P-12, 424P-18, 424P-25, 424P-32

Juego de 6 formones profesionales con mango bi-material en caja de madera



**424P-S6-EUR**

	€		
6	149,03	1	424P-S6-EUR

424P-6, 424P-10, 424P-12, 424P-18, 424P-25, 424P-32

Juego de 6 formones con mango bi-componente en caja de madera



**424P-S6-GER**

	€		
6	138,60	1	424P-S6-GER

424P-6, 424P-10, 424P-12, 424P-16, 424P-20, 424P-26

Juego de 8 formones con mango bi-componente en caja de madera



**424P-S8-EUR**

	€		
8	203,23	1	424P-S8-EUR

424P-6, 424P-10, 424P-12, 424P-16, 424P-18, 424P-25, 424P-32, 424P-38

Juego de 6 formones con mango bi-componente en bolsa de poliéster



**424P-S6-PP**

	€		
6	100,92	1	424P-S6-PP

424P-6, 424P-10, 424P-12, 424P-18, 424P-25, 424P-32

Formón con mango de polipropileno



**414**

	€		
6 mm	15,71	4	414-6
8 mm	16,07	4	414-8
10 mm	15,88	4	414-10
12 mm	16,93	4	414-12
14 mm	17,27	4	414-14
15 mm	17,42	4	414-15
16 mm	17,61	4	414-16
18 mm	18,09	4	414-18
20 mm	18,43	4	414-20
22 mm	18,90	4	414-22
25 mm	19,41	4	414-25
28 mm	20,06	4	414-28
30 mm	20,38	4	414-30
32 mm	20,72	4	414-32
35 mm	21,37	4	414-35
38 mm	21,87	4	414-38

Formón con mango monomaterial rojo



**1031**

	€		
4 mm	25,54	5	1031-4
6 mm	26,11	5	1031-6
8 mm	26,66	5	1031-8

	€		
10 mm	27,48	5	1031-10
12 mm	28,19	5	1031-12
14 mm	28,75	5	1031-14
16 mm	29,30	5	1031-16
18 mm	29,99	5	1031-18
20 mm	30,70	5	1031-20
22 mm	31,37	5	1031-22
25 mm	32,22	5	1031-25
28 mm	33,20	5	1031-28
30 mm	33,87	5	1031-30
32 mm	34,58	5	1031-32
40 mm	37,07	5	1031-40

Juego de 3 formones con mango de polipropileno en caja de cartón



**414-S3-EUR**

	€		
3	54,41	1	414-S3-EUR

414-12, 414-18, 414-25

Juego de 5 formones con mango monomaterial rojo, en blister



**9883**

	€		
5	146,50	1	9883

1031-6, 1031-12, 1031-16, 1031-20, 1031-25





Formón con mango de madera



**425**

	€		
4 mm	13,92	4	425-4
6 mm	14,43	4	425-6
8 mm	14,64	4	425-8
10 mm	14,98	4	425-10
12 mm	15,34	4	425-12
14 mm	15,69	4	425-14
15 mm	15,87	4	425-15
16 mm	16,05	4	425-16
18 mm	16,42	4	425-18
20 mm	16,76	4	425-20
22 mm	17,10	4	425-22
24 mm	17,48	4	425-24
25 mm	17,64	4	425-25
26 mm	17,82	4	425-26
28 mm	18,17	4	425-28
30 mm	18,55	4	425-30
32 mm	18,87	4	425-32
35 mm	19,43	4	425-35
38 mm	19,98	4	425-38
40 mm	20,28	4	425-40

Juego de 3 formones con mango de madera en caja de cartón



**425-081**

	€		
3	49,39	1	425-081

425-12, 425-18, 425-25

Juego de 5 formones con mango de madera en caja de cartón



**425-082**

	€		
5	78,68	1	425-082

425-6, 425-10, 425-12, 425-18, 425-25

Juego de 6 formones con mango de madera en caja de madera



**425-083**

	€		
6	103,90	1	425-083

425-6, 425-10, 425-12, 425-18, 425-25, 425-32

Mango de repuesto para formones 1031



**956**

L	g	€		
108 mm	50 g	5,58	1	956

**CINCELES GUBIA**

Gubias profesionales con mango bi-componente



**422P**

	€		
6 mm	37,50	4	422P-6
10 mm	37,97	4	422P-10
12 mm	37,97	4	422P-12
16 mm	37,97	4	422P-16
20 mm	40,23	4	422P-20
25 mm	47,79	4	422P-25

**CINCELES DE DEMOLICIÓN**

Cuchillo formón



**2448**

	L	€		
25 mm	231 mm	30,81	12	2448
25 mm	240 mm	31,59	12	SB-2448

Cuchillo alta resistencia hoja curvada caja expositora 12 uds



**2449**

	L	€		
25 mm	235 mm	28,31	12	2449
25 mm	235 mm	28,31	10	SB-2449



## ACCESORIOS PARA FORMONES

Piedra de afilado natural



**528-700**

	€		
150 mm	49,98	1	528-700

Bloque para afilado



**SBC110**

		€		
30 x 65 x 110 mm	67 g	2,56	1	SBC110-65

Piedra de afilado - 2 granos



**528-COM**

	€		
150 mm	41,82	1	528-COM

Hoja de repuesto para disco de esmerilado



**BP-40-95**

		€		
112 mm	55 g	3,97	12	BP-40-95

Accesorio para formones



**BP-40**

	€		
160 mm	50,60	1	BP-40

Funda protectora de plástico



**WC-HOL**

	€		
292 mm	4,25	1	WC-HOL





**BAHCO®**



## Tijeras y cuchillos



## TIJERAS CORTACHAPAS

Tijera cortachapas articulada, corte recto



**MA421**

	€			MA421
250 mm	30,50	10		

Tijera cortachapas multiuso, corte largo



**MA431**

	€			MA431
290 mm	33,45	1		

0.53mm acero inox 0.94mm laminado en frío

Tijera cortachapa articulada, corte derecha



**MA411**

	€			MA411
250 mm	30,50	10		

8698M0250: Juego de piezas de repuesto (tuerca, muelle y husillo)

Tijera cortachapa articulada profesional, corte derecha



**MA321**

	€			MA321
260 mm	39,82	10		

0.9mm acero inox 1.5mm laminado en frío

Tijera cortachapa articulada, corte izquierda



**MA401**

	€			MA401
250 mm	30,50	10		

8698M0250: Juego de piezas de repuesto (tornillo, muelle y husillo)

Tijera cortachapas articulada profesional, corte izquierda



**MA311**

	€			MA311
260 mm	39,82	1		

0.9mm acero inox 1.5mm laminado en frío

Tijera para chapa



**MA225R**

	€			MA225R
250 mm	52,54	4		

Tijera cortachapa articulada, corte derechas



**MA361**

	€			MA361
260 mm	44,60	10		

1mm acero inox 1.5mm laminado en frío

Tijera cortachapas articulada profesional, corte izquierda



**MA351**

	€			MA351
250 mm	44,60	10		

1mm Acero inox 2mm Laminado en frío

Tijera para chapa tradicional



**M227L**

	€		
270 mm	38,03	4	M227L

0.6mm Acero inox 1.2mm Acero laminado

Tijera para chapa tradicional



**M526**

	€		
260 mm	38,44	4	M526

Tijera para chapa de dos manos



**M676**

	€		
760 mm	129,20	1	M676-SH*

SH: Cuchilla repuesto

Tijera para chapa tradicional



**M227R**

	€		
270 mm	38,03	4	M227R

Tijera para chapa tradicional



**MR227L**

	€		
270 mm	47,34	4	MR227L

**TIJERAS ELECTRICISTA**

Tijera electricista 140mm



**SCB140**

	€		
43 mm 140 mm	27,33	10	SCB140

Tijera para chapa tradicional



**M330**

	€		
11 3/4 mm	74,17	4	M330

Tijeras para chapa de dos manos



**M6376**

	€		
760 mm	129,44	1	M6376-SH

Tijera electricista 140mm con entalla



**SCB140G**

	€		
43 mm 140 mm	29,99	10	SCB140G

\* Hasta agotar existencias





Tijera de electricista

**SC127/SC127S**

Blade Length	Handle Length	Price (€)	Quantity	Model
45 mm	130 mm	13,21	10	SC127
45 mm	127 mm	13,64	10	SC127S

S= Con hoja dentada

Tijera de electricista

**SC140/SC140C**

Blade Length	Handle Length	Price (€)	Quantity	Model
50 mm	145 mm	13,89	10	SC140
50 mm	145 mm	14,56	10	SC140C

C=Curva

Tijera de electricista, modelo extra fuerte

**SC150NG**

Blade Length	Handle Length	Price (€)	Quantity	Model
38 mm	155 mm	19,30	10	SC150NG

Tijera especial corta para estaño

**2704**

Length	Price (€)	Quantity	Model
110 mm	36,61	1	2704A

Tijera especial para agarrar

**2705R**

Length	Price (€)	Quantity	Model
160 mm	31,65	1	2705R

**CUCHILLOS**

Cutter retráctil ERGO™



ergo

**KERU01**

Length	Blade Length	Price (€)	Quantity	Model
170 mm	26 mm	21,50	5	KERU-01

Cutter ERGO™



ergo

**KEFU-01**

Length	Blade Length	Price (€)	Quantity	Model
170 mm	26 mm	19,33	5	KEFU-01

Cutter ERGO™ hoja seccionable 18mm



ergo

**KE18-01**

Length	Blade Length	Price (€)	Quantity	Model
161 mm	26 mm	16,48	5	KE18-01

Cutter retráctil

**KBRU-01**

Length	Blade Length	Price (€)	Quantity	Model
170 mm	26 mm	18,55	5	KBRU-01

Cutter retráctil



**KGRU-01**

		€		
160 mm	26 mm	13,24	5	KGRU-01

Cutter de hoja deslizante



**SQZ150003**

		€		
170 mm	60 mm	24,83	6	SQZ150003

Hojas para cutter



**KBGU**

	€		
0.635 x 19 x 60 mm	33,58	1	KBGU-100P

Cutter retráctil



**KGRU-02**

		€		
145 mm	26 mm	11,77	5	KGRU-02

Cutter cuchilla fija



**KBFU-01**

		€		
170 mm	26 mm	16,70	5	KBFU-01

Dispensador hojas trapezoidales, 5 piezas



**KBGU-5P-DISPEN**

	€		
0.635 x 19 x 60 mm	3,02	20	KBGU-5P-DISPEN

Cutter mini retráctil



**KMU-01**

		€		
90 mm	26 mm	8,84	5	KMU-01

Cutter cuchilla fija



**KGFU-01**

		€		
160 mm	26 mm	11,92	5	KGFU-01

Dispensador con 10 hojas trapezoidales



**KBGU-10P-DISPEN**

	€		
0.635 x 19 x 60 mm	5,20	20	KBGU-10P-DISPEN



Dispensador hojas gancho, 5 piezas



**KBGH-5P-DISPEN**

	€		
0.635 x 19 x 51 mm	3,52	20	KBGH-5P-DISPEN

Dispensador hojas seguridad, 5 piezas



**KBGR-5P-DISPEN**

	€		
0.635 x 19 x 55 mm	4,83	20	KBGR-5P-DISPEN

Hojas de recambio



**SQZ150003-HSBL**

	€		
51 mm	14,79	6	SQZ150003-HSBL*

Hojas de recambio en forma de gancho para cutter universal

Cutter hoja seccionable ABS mango TPR 9 mm



**KB09-01**

	€		
140 mm	8,84	5	KB09-01

Cutter hoja seccionable 18mm TPR



**KB18-01**

	€		
160 mm	11,20	5	KB18-01

Cutter hoja seccionable 9 mm



**KG09-01**

	€		
140 mm	6,33	5	KG09-01
140 mm	18,99	10	KG09-01-3P

Cutter hoja seccionable 18mm



**KG18-01**

	€		
160 mm	8,23	5	KG18-01

Dispensador 10 hojas Snap Off 9 mm



**KSBG09-10DISPEN**

	€		
1 x 9 x 85 mm	4,64	20	KSBG09-10DISPEN

Pack de 5 hojas no seccionables 18 mm



**KUBG**

	€		
0.7 x 85 x 9 mm	3,14	20	KUBG09-5P*

Dispensador hojas Snap Off 18mm, 5 piezas



**KUBG18-5DISPEN**

	€		
15 x 30 x 130 mm	4,32	20	KUBG18-5DISPEN

Dispensador con 10 hojas de 18 mm



**KSBG18-10DISPEN**

	€		
15 x 30 x 130 mm	6,06	20	KSBG18-10DISPEN

Cuchillo de seguridad



**KGAU-01**

	€		
160 mm	16,89	5	KGAU-01

Dispensador cuchillas mini cutter



**SQZ-MINI-BLADE**

	€		
28 mm	5,38	1	SQZ-MINI-BLADE

Navaja hoja intercambiable mango poliamida



**KGSU-01**

	€		
160 mm	15,89	5	KGSU-01

Soporte para navaja



**KHU-01**

	€		
90 g	4,96	4	KHU-01

Navaja doble hoja mango de aluminio



**KBTU-01**

	€		
160 mm	32,38	5	KBTU-01

Cuchillo Laplander con mango verde bi-componente



**2446-LAP**

		€		
218 mm	102 mm	8,59	15	2446-LAP
218 mm	102 mm	10,61	10	SB2446-LAP

SB: embalaje blister

Mini cutter multi usos



**SQZ-MINI**

	€		
160 mm	10,01	24	SQZ-MINI

Navaja deportiva plegable para corte de cuerda



**KBSK-01**

	€		
170 mm	20,61	5	KBSK-01

Cuchillo multiuso con hoja de acero inoxidable



**2446**

		€		
225 mm	100 mm	11,42	15	2446

Navaja hoja intercambiable



**KBSU-01**

	€		
160 mm	20,61	5	KBSU-01

\* Hasta agotar existencias



Display con 15 cuchillos multiusos de acero inoxidable con mango bi-componente



**2446-BL**

		€		
218 mm	102 mm	9,65	15	2446-BL

Cuchillo electricista



**2446-EL**

		€		
32 mm	150 mm	9,66	12	2446-EL

Cuchillo pelacables para electricista - Para diestros



**2446-ELR**

		€		
34 mm	145 mm	9,66	12	2446-ELR

Cuchillo de seguridad



**2446-SAFE**

		€		
215 mm	95 mm	9,40	15	2446-SAFE

Cuchillo mango robusto bi-componente, en blister



**SB2446-EL**

		€		
150 mm	32 mm	10,01	10	SB2446-EL

Cuchillo robusto multiusos



**2446-OV**

		€		
220 mm	100 mm	11,42	15	2446-OV

Cuchillo para lino



**2446-LINO**

		€		
180 mm	55 mm	8,98	12	2446-LINO

Cuchillos pelacables de electricista - uso mano derecha



**2446-ELL**

		€		
34 mm	145 mm	9,66	12	2446-ELL

Cuchillo de electricista con funda



**2446-EL-HELP**

	€		
43 mm	10,56	12	2446-EL-HELP



Cuchillo multiusos con hoja de acero inoxidable



**1446**

		€		
220 mm	100 mm	7,36	15	1446

Cuchillo flotante con mango fluorescente



**1446-FLOAT-B**

		€		
225 mm	100 mm	6,68	12	1446-FLOAT-B

Cubo para cuchillos 1446-FLOAT



**BUCKET-1446-FLOAT**

	€		
25 l	820,02	1	BUCKET-1446-FLOAT

Display con 15 cuchillos multiusos de acero al carbono



**1446-CS**

		€		
218 mm	102 mm	7,73	15	1446-CS

Cubo vacío



**BUCKET-EMPTY**

	€		
25 l	16,97	6	BUCKET - EMPTY

BUCKET - EMPTY

1446-FLOATx 75

Cuchillo robusto multiusos



**1446-OV**

		€		
225 mm	100 mm	12,20	15	1446-OV

Cuchillo de rescate flotante



**1446-FLOAT**

		€		
226 mm	102 mm	12,69	15	1446-FLOAT

Cubo con 75 cuchillos de acero al carbono



**BUCKET-1446-CS**

	€		
25 l	666,25	1	BUCKET - 1446-CS

Cuchillo punzón electricista



**2820EK-01**

		€		
25 mm	130 mm	6,20	12	2820EK-01

BUCKET - EMPTY

1446-CSx 75



Navaja de electricista



**2820EK**

		€		
95 mm	205 mm	7,91	6	2820EK

Navaja para electricista, plegable, mango de madera



**2820EF1**

		€		
90 mm	200 mm	9,87	12	2820EF1

Navaja para electricista, plegable, mango de plástico



**2820EF2**

		€		
85 mm	195 mm	12,69	8	2820EF2

Navaja para electricista, plegable, mango de plástico



**2820EF3**

		€		
80 mm	170 mm	16,43	1	2820EF3

Navaja para electricista, plegable, mango de plástico



**2820EF4**

		€		
75-85 mm	170 mm	20,53	1	2820EF4

Multiherramienta



**MTT151**

	€		
150 mm	43,36	6	MTT151

Multiherramienta con llavero



**MTT121**

	€		
110 mm	21,13	8	MTT121

Multi herramienta 12 en 1 cuerpo de aluminio



**MTT051**

	€		
165 mm	25,88	6	MTT051

Raspador ventanas cuerpo de metal



**KRSS-01**

	€		
80 g	6,91	10	KRSS-01

Rasqueta de ventanas, cuerpo de plástico bicomponente



**KBWS-01**

	€		
70 g	6,20	10	KBWS-01



## Mordazas y tornillos de banco

## MORDAZAS DE BANCO

### Mordaza Rápida



#### QCB

L	€		
456 mm	32,59	6	QCB-150
606 mm	34,94	6	QCB-300
756 mm	37,31	6	QCB-450
906 mm	40,05	4	QCB-600
1206 mm	43,78	4	QCB-900
1556 mm	52,52	8	QCB-1250

### Mordaza Rápida



#### QCG

L	€		
380 mm	21,62	6	QCG-150
530 mm	24,61	6	QCG-300

### Mordaza rápida



#### QC

X	L	€		
1	230 mm	3,24	12	QC-115A
2	230 mm	6,47	6	QC-115A-2P
1	305 mm	7,29	6	QC-150A
2	305 mm	14,60	6	QC-150A-2P
1	475 mm	11,48	6	QC-300A
2	475 mm	22,97	4	QC-300A-2P

-2P: 2 unidades

## Mordazas



#### 3066

L		€		
250 mm	90 mm	22,74	5	306601500
300 mm	90 mm	24,45	5	306602000
400 mm	90 mm	27,51	5	306603000
510 mm	90 mm	30,26	5	306604000

## Mordazas



#### 3067

L		€		
415 mm	125 mm	29,64	5	306703000
510 mm	125 mm	32,09	5	306704000
610 mm	125 mm	34,99	5	306705000
710 mm	125 mm	37,29	5	306706000
910 mm	125 mm	42,78	5	306708000
1115 mm	125 mm	48,61	5	306710000
1310 mm	125 mm	54,70	2	306712000
1610 mm	125 mm	62,64	2	306715000

## Mordazas



#### 3068

L		€		
430 mm	155 mm	53,02	5	306803000
535 mm	155 mm	56,55	5	306804000
640 mm	155 mm	59,78	2	306805000
730 mm	155 mm	62,56	2	306806000
820 mm	155 mm	68,59	2	306808000
1135 mm	155 mm	73,86	2	306810000
1335 mm	155 mm	78,37	2	306812000
1630 mm	155 mm	85,21	1	306815000
2130 mm	155 mm	93,58	1	306820000

## Mordazas



#### 3069

L		€		
430 mm	225 mm	85,25	2	306903000
540 mm	225 mm	88,46	2	306904000
638 mm	225 mm	91,66	2	306905000
730 mm	225 mm	94,74	2	306906000
932 mm	225 mm	101,00	2	306908000
1130 mm	225 mm	107,11	2	306910000

## Mordaza con mango de plástico



#### 420SH

L		€		
100 mm	50 mm	14,90	10	420SH-50-100
200 mm	50 mm	16,50	10	420SH-50-200
120 mm	60 mm	24,45	12	420SH-60-120
300 mm	60 mm	29,14	12	420SH-60-300
160 mm	80 mm	32,41	12	420SH-80-160
200 mm	100 mm	38,08	10	420SH-100-200
250 mm	120 mm	45,13	8	420SH-120-250
300 mm	120 mm	48,99	8	420SH-120-300
400 mm	120 mm	51,45	6	420SH-120-400
500 mm	120 mm	54,92	6	420SH-120-500
600 mm	120 mm	59,37	6	420SH-120-600
800 mm	120 mm	65,31	6	420SH-120-800
1000 mm	120 mm	69,08	6	420SH-120-1000
1250 mm	120 mm	78,49	6	420SH-120-1250
1500 mm	120 mm	82,39	6	420SH-120-1500
400 mm	140 mm	65,31	6	420SH-140-400
400 mm	175 mm	69,65	6	420SH-175-400

Mordaza muelle



**420SC**

	g	€		
25 mm	60 g	5,89	10	420SC-25
50 mm	120 g	8,79	5	420SC-50

Tornillo de banco, guía redonda



**6010**

	€		
80 mm	246,27	1	601000800
100 mm	328,34	1	601001000
125 mm	452,24	1	601001250
150 mm	642,79	1	601001500

Compatible con base giratoria 833SB Mordaza y husillo de repuesto 6010M y 6010H

Mordaza para tubos



**833P**

	€		
100 mm	34,25	1	833PJ-4
125 mm	42,56	1	833PJ-5
150 / 175 mm	42,56	1	833PJ-67

**TORNILLOS DE BANCO**

Tornillo de banco, guía cuadrada



**834V**

	€		
100 mm	300,32	1	834V-4
125 mm	403,55	1	834V-5
150 mm	509,92	1	834V-6
175 mm	663,20	1	834V-7

Tornillo lateral para regular la holgura Mordaza 6072M y husillo 6070H

Tornillo de sobremesa



**834V-2**

	€		
63 mm	130,04	1	834V-2

Husillo de repuesto para tornillo de banco 6072



**6070H**

	€		
100 mm	45,05	1	6070H1000
125 mm	64,12	1	6070H1250
150 mm	114,62	1	6070H1500
175 mm	147,43	1	6070H1750

Tornillo de banco, guía cuadrada



**6072**

	€		
100 mm	255,55	1	607201000
125 mm	357,77	1	607201250
150 mm	459,99	1	607201500
175 mm	613,32	1	607201750

Compatible con base giratoria 833SB

Mordazas con tornillos de repuesto para tornillo de banco 6072



**6072M**

	€		
100 mm 834V-4, 607201000	30,52	1	6072M1000
150 mm 834V-6, 607201500	47,33	1	6072M1500
175 mm 834V-7, 607201750	58,40	1	6072M1750

Mordazas de repuesto para tornillo de banco 6010



**6010M**

	€		
80 mm 601000800	25,56	1	6010M0800
100 mm 601001000	26,18	1	6010M1000
125 mm 834V-5, 607201250, 601001250	38,72	1	6010M1250
150 mm 601001500	47,39	1	6010M1500







Husillo y tuerca de repuesto para tornillo 6010





### 6010H

	€		
80 mm	50,14	1	6010H0800
100 mm	59,65	1	6010H1000
125 mm	81,32	1	6010H1250
150 mm	138,29	1	6010H1500

Mordazas de aluminio



### 833AJ

	€		
100 mm	38,03	1	833AJ-4
125 mm	39,49	1	833AJ-5
150 mm	41,11	1	833AJ-6

Mordazas y husillos de repuesto para tornillo de banco 834V-2





### 6040M/H

	€		
63 mm	21,38	1	6040M0630

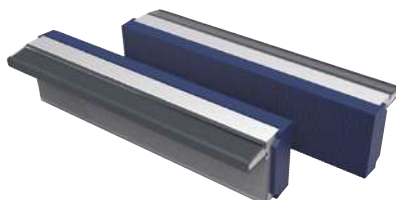
Mordazas de fibra



### 833FJ





	€		
100 mm	43,41	1	833FJ-4
125 mm	44,71	1	833FJ-5
150 mm	46,48	1	833FJ-6

## ACCESORIOS PARA TORNILLOS DE BANCO

Base giratoria para 6010,6072 y 834V



### 833SB

		€		
80 mm	100 mm	63,65	1	833SB-4
100 mm	125 mm	97,14	1	833SB-5
125 mm	150 mm	112,23	1	833SB-6
150 mm	175 mm	145,70	1	833SB-7



## Martillos



## MARTILLOS DE CARPINTERO

Martillo Carpintero ERGO™



ergo



**529**

	€		
450 g	39,80	4	529-16-L
450 g	41,94	4	529-16-XL
570 g	41,94	4	529-20-L
570 g	44,06	4	529-20-XL*

Martillo de carpintero ERGO™



ergo



**529S**

	€		
450 g	40,92	4	529S-16-XL
570 g	42,99	4	529S-20-XL

Martillo de carpintero



**429**

	€		
230 g	19,00	4	429-8
370 g	27,66	4	429-13
450 g	30,15	4	429-16
570 g	31,02	4	429-20

Martillo de carpintero



**428**

	€		
450 g	28,18	4	428-16

Martillo de uña con mango de fibra de vidrio



**428F**

	€		
230 g	25,48	4	428F-8
370 g	28,35	4	428F-13
454 g	31,57	4	428F-16
567 g	33,60	4	428F-20
680 g	46,01	4	428F-24

Martillo de uña RIP con mango de fibra de vidrio



**428S**

	€		
454 g	31,57	4	428S-16*
567 g	33,60	4	428S-20*

Martillo de carpintero



**427**

	€		
230 g	19,72	4	427-8*
370 g	21,72	4	427-13*
450 g	29,96	4	427-16
570 g	30,98	4	427-20
680 g	33,58	4	427-24*

Martillo de uña RIP con mango de madera



**427S**

	€		
454 g	23,12	4	427S-16*
567 g	25,50	4	427S-20*

Martillo de carpintero, mango madera



**427**

	€		
700 g	24,74	6	427-700*

Martillo de carpintero, mango fibra de vidrio



**428**

€	Icono	Icono
700 g	32,03	6 428-700*

## EXTRACTORES DE CLAVOS

Extractor de clavos con mango de agarre cómodo de plástico termoinyectado



**36**

€	Icono	Icono
220 mm	47,00	5 36

Muelle interior patentado

## MARTILLOS DE MECÁNICO

Martillo de bola



**479**

€	Icono	Icono
230 g	18,89	6 479-08
340 g	20,15	6 479-12
450 g	23,07	6 479-16
570 g	24,70	6 479-20
800 g	26,42	6 479-24
900 g	28,53	6 479-32

Martillo de bola con mango de fibra vidrio



**479F**

€	Icono	Icono
230 g	21,86	6 479F-08
340 g	23,19	6 479F-12
450 g	26,53	6 479F-16
570 g	28,41	6 479F-20
680 g	30,39	6 479F-24
900 g	32,81	6 479F-32

Martillo de cerrajero - tipo alemán DIN



**481**

€	Icono	Icono
100 g	12,75	6 481-100
200 g	14,31	6 481-200
300 g	16,87	6 481-300
400 g	18,64	6 481-400
500 g	21,44	6 481-500
800 g	28,60	6 481-800
1000 g	31,44	6 481-1000
1500 g	42,92	6 481-1500
2000 g	63,18	6 481-2000

Martillo alemán DIN con mango fibra de vidrio



**481F**

€	Icono	Icono
100 g	14,67	6 481F-100
200 g	16,45	4 481F-200

€	Icono	Icono
300 g	19,41	6 481F-300
400 g	21,44	6 481F-400
500 g	24,66	6 481F-500
800 g	32,90	6 481F-800
1000 g	36,14	6 481F-1000
1500 g	49,36	4 481F-1500
2000 g	72,67	4 481F-2000

Martillo para ribete - tipo francés



**482**

€	Icono	Icono
300 g	16,56	6 482-25
400 g	18,04	6 482-28
500 g	20,96	6 482-30
800 g	24,62	6 482-35
1000 g	27,30	6 482-40
1500 g	28,57	6 482-45

Martillo rivoir con mango fibra de vidrio



**482F**

€	Icono	Icono
300 g	19,06	4 482F-25
400 g	20,74	4 482F-28
470 g	24,11	6 482F-30
800 g	28,31	4 482F-35
1000 g	31,38	2 482F-40
1500 g	32,85	4 482F-45

\* Hasta agotar existencias



Martillo Warrington



**480**

	€		
230 g	23,74	4	480-08
280 g	25,67	6	480-10
340 g	27,74	6	480-12
400 g	37,90	6	480-14
570 g	31,20	4	480-20

Martillo de carpintero



**485W**

	€		
650 g	29,60	6	485W-650
750 g	31,39	6	485W-750
	9,55	1	SH-485W
	7,59	1	SH-485W-PLATES

Martillo inglés



**490**

	€		
100 g	22,89	4	490-3.5*

Martillo de bola



**492**

	€		
100 g	29,34	6	492-3.5*

Martillo de ebanista



**483**

	€		
100 g	10,23	6	483-16
160 g	11,38	6	483-20
200 g	12,32	6	483-22
300 g	13,88	6	483-25
400 g	15,43	6	483-28

Maceta



**484**

	€		
1000 g	31,39	6	484-1000
1250 g	35,51	6	484-1250
1500 g	40,18	6	484-1500
2000 g	44,27	4	484-2000

**MARTILLOS PARA CONSTRUCCIÓN**

Martillo de carpintero



**485**

	€		
600 g	32,31	6	485

Martillo de ebanista con mango fibra de vidrio



**483F**

	€		
100 g	11,76	6	483F-16
160 g	13,09	6	483F-20
200 g	14,17	6	483F-22
300 g	15,97	6	483F-25
400 g	17,74	6	483F-28
500 g	19,37	4	483F-30

Maceta con mango fibra de vidrio



**484F**

	€		
1000 g	36,10	6	484F-1000
1250 g	40,84	6	484F-1250
1500 g	46,21	6	484F-1500
2000 g	50,90	4	484F-2000



Maceta de albañil



**407**

	€		
700 g	15,87	5	407-700*
1000 g	17,62	6	407-1000*
1400 g	19,70	6	407-1400*

Maceta mango fibra de vidrio



**407F**

	€		
700 g	18,45	6	407F-700
1000 g	20,35	6	407F-1000
1400 g	23,24	6	407F-1400

Maza cuadrada, mango madera



**488**

	€		
2000 g	36,28	2	488-2000
3000 g	43,86	2	488-3000
4000 g	50,83	2	488-4000
5000 g	60,80	2	488-5000
6000 g	66,82	1	488-6000

Maza cuadrada, mango fibra de vidrio



**488F**

	€		
2000 g	40,86	2	488F-2000
3000 g	47,68	2	488F-3000
4000 g	53,97	2	488F-4000
5000 g	64,08	4	488F-5000
6000 g	69,55	2	488F-6000

Martillo de albañil



**486W**

	€		
500 g	23,74	4	486W-500
600 g	24,46	4	486W-600
	8,94	1	SH-486W

Piqueta 700g, mango madera



**486-700**

	€		
700 g	23,61	6	486-700*

Piqueta 700g, mango fibra de vidrio



**486F**

	€		
700 g	30,25	6	486F-700*

Martillo de albañil



**486**

	€		
600 g	31,17	4	486

Fijas de albañil



**4401**

	€		
255 mm	6,21	10	440102500
300 mm	6,53	10	440103000*

\* Hasta agotar existencias



Mangos de madera de repuesto



WSH

Icon	€	Icon	Icon
407	4,64	1	SH-407
491-3000 & 491-4000	18,82	12	SH-491-34
491-5000 & 491-6000	29,93	12	SH-491-56
488-2000	13,40	10	SH-488-2000
488-3000, 488-4000	19,41	10	SH-488-34
488-5000, 488-6000	21,19	10	SH-488-56
427-700	6,15	10	SH-427-700
486-700, 495-500, 495-600, 493-500, 493-600	6,15	10	SH-486-493-495

Alcotana pala-hacha, mango fibra de vidrio



493F

Icon	€	Icon	Icon
500 g	28,26	6	493F-500*
600 g	30,75	1	493F-600*

Martillo hacha



494

Icon	€	Icon	Icon
600 g	32,15	6	494-600

Mangos de fibra de vidrio de repuesto



FSH

Icon	€	Icon	Icon
488F-2000	16,53	10	SH-488F-2000
488F-3000 & 488F-4000	20,50	1	SH-488F-34
488F-5000 & 488F-6000	21,87	1	SH-488F-56
428-700	8,88	10	SH-428-700
486F-700, 495F-500, 495F-600, 493F-500, 493F-600	8,88	10	SH-486F493F495F

Alcotana pala-pico, mango madera



495

Icon	€	Icon	Icon
500 g	24,05	6	495-500*
600 g	25,07	6	495-600*

Martillo anti-rebote



3625AR

g	€	Icon	Icon
550 g	35,32	34	3625AR-35
1430 g	58,34	18	3625AR-50
1550 g	75,90	12	3625AR-60

MARTILLOS ESPECIALES

Alcotana pala-hacha, mango madera



493

Icon	€	Icon	Icon
500 g	23,57	6	493-500*
600 g	25,28	6	493-600*

Alcotana pala-pico, mango fibra de vidrio



495F

Icon	€	Icon	Icon
500 g	27,52	6	495F-500*
600 g	30,25	1	495F-600*

Taco de repuesto para martillos 3625AR



3625ARL

Icon	Icon	€	Icon	Icon
35 mm	3625AR-35	1,44	6	3625ARL-35
50 mm	3625AR-50	5,71	6	3625ARL-50
60 mm	3625AR-60	9,55	6	3625ARL-60

Mango de repuesto para martillos 3625AR



### 3625ARLH

	L	€		
3625AR-35	290 mm	4,74	80	3625ARLH-35
3625AR-60	300 mm	5,01	50	3625ARLH-50
3625AR-60	390 mm	5,27	16	3625ARLH-60

Maza con pico



### 491

	€		
3000 g	38,00	4	491-3000
4000 g	42,31	4	491-4000
5000 g	50,01	4	491-5000
6000 g	55,28	4	491-6000

## MARTILLOS Y MAZAS BLANDOS

Martillo de plástico Polyflex



### 3625Y

g	€		
120 g	43,49	6	3625Y-22
225 g	62,38	6	3625Y-32
372 g	86,20	6	3625Y-40
484 g	121,49	6	3625Y-50

Martillo anti-rebote



### 3625PU

	€		
300 g	31,57	12	3625PU-30
790 g	52,11	6	3625PU-50
1080 g	78,60	6	3625PU-60

Mango irrompible



### 489-1100/489-1800

	€		
1100 g	114,41	8	489-1100
1800 g	114,77	8	489-1800

Par de bocas de repuesto para 3625Y



### 3625YL

		€		
3625Y-22	22 mm	17,55	20	3625YL-22
3625Y-32	32 mm	30,48	20	3625YL-32
3625Y-35	35 mm	36,90	1	3625YL-35*
3625Y-40	40 mm	54,25	20	3625YL-40
3625Y-50	50 mm	89,94	20	3625YL-50

Martillo anti-rebote



### 3625PU-105

	g	€		
5000 g	5600 g	257,88	4	3625PU-105

Maza de seguridad



### 489-2700/489-5400

	€		
2700 g	215,30	4	489-2700
3600 g	256,47	4	489-3600
4500 g	277,74	4	489-4500
5400 g	308,95	4	489-5400

Martillo de plástico Superflex



### 3625N

g	€		
120 g	46,26	6	3625N-22
225 g	49,97	6	3625N-32
372 g	84,08	6	3625N-40
484 g	101,88	6	3625N-50
	14,72	1	3625NLH-32*

\* Hasta agotar existencias



Boca para martillo de acetato de celulosa  
3625N



**3625NL**

	Ø	€		
3625N-22	22 mm	12,97	20	3625NL-22
3625N-32	32 mm	22,10	20	3625NL-32
3625N-40	40 mm	38,41	20	3625NL-40
3625N-50	50 mm	64,13	20	3625NL-50

Maza mango madera, boca de nylon



**3625W**

g	€		
150 g	11,34	120	3625W-22
250 g	16,21	1	3625W-28
490 g	20,42	1	3625W-35
1050 g	29,81	1	3625W-44
1470 g	57,33	12	3625W-55

WL: Tacos de recambio WLH: Mango de repuesto

Bocas de repuesto para 3625W y 3625S



**3625WL**

	Ø	€		
3625W-22	22 mm	4,32	10	3625WL-22
3625W-28, 3625S-28	28 mm	4,79	10	3625WL-28
3625W-35, 3625S-35	35 mm	5,83	10	3625WL-35
3625W-44, 3625S-44	44 mm	6,38	10	3625WL-44
3625W-55	55 mm	8,44	6	3625WL-55

Mango de repuesto para martillos 3625W



**3625WLH**

	€		
3625W-22	3,49	50	3625WLH-22
3625W-28	3,68	50	3625WLH-28
3625W-35	3,94	80	3625WLH-35
3625W-44	4,61	50	3625WLH-44
3625W-55	4,88	16	3625WLH-55

Martillo boca nylon - Mango de acero



**3625S**

g	€		
350 g	24,21	50	3625S-28
610 g	32,28	30	3625S-35
1100 g	45,70	18	3625S-44

Maza de goma negra



**3625RM**

g	€		
290 g	11,24	50	3625RM-55
460 g	12,13	40	3625RM-65
660 g	14,54	30	3625RM-75
850 g	17,66	20	3625RM-90

Maceta de cobre



**4130**

	€		
500 g	65,69	12	413005000
1000 g	108,23	12	413010000
1500 g	142,14	12	413015000
2000 g	186,25	6	413020000
3000 g	189,06	1	413030000
4000 g	250,99	1	413040000



## Herramientas forestales y de tala de árboles





## HACHAS, ALCOTANAS Y MAZAS

Hachas con mango de madera



### HUS

	g	€		
380 mm	770 g	34,54	4	HUS-0.6-380
500 mm	1080 g	38,63	4	HUS-0.8-500

Hacha tipo Alemán



### HGPS

	g	€		
380 mm	944 g	33,94	4	HGPS-0.8-380-WB
400 mm	1130 g	35,79	4	HGPS-1.0-400-WB
360 mm	790 g	23,97	10	HGPS-0.6-360
380 mm	1020 g	29,30	4	HGPS-0.8-380
400 mm	1260 g	32,78	4	HGPS-1.0-400

Hachas con mango de madera



### HUS-1.0-650

	g	€		
650 mm	1380 g	43,47	4	HUS-1.0-650

Hacha con mango en fibra de vidrio



### HFGPS

	g	€		
380 mm	1010 g	46,85	4	HFGPS-0,7-400FG

Hacha tipo Alemán



### FGS-810

	g	€		
800 mm	2260 g	56,74	4	FGS-1.6-810
800 mm	2460 g	61,74	4	FGS-1.8-810

Hacha tipo Canadiense, mango de nogal



### FCP

	g	€		
800 mm	2500 g	84,34	4	FCP-1.8-810
850 mm	3000 g	93,82	2	FCP-2.3-860

Hacha tipo Alemán



### FGS

	g	€		
700 mm	1730 g	53,23	4	FGS-1.25-700-WB
810 mm	2210 g	59,64	4	FGS-1.6-810-WB
600 mm	1400 g	47,78	4	FGS-1.0-600
700 mm	1850 g	50,36	4	FGS-1.25-700

Hacha con mango en fibra de vidrio



### FFSS

	g	€		
900 mm	2400 g	70,03	4	FFSS-1.5-900FG

Hacha



### SUS

	g	€		
800 mm	2600 g	86,02	4	SUS-2.0-800

Hacha tipo Canadiense, Mango de nogal



### MCP

	g	€		
800 mm	3280 g	75,60	2	MCP-2.5-810

Maza con mango en fibra de vidrio



### LS-MASSE

	g	€		
900 mm	4800 g	59,18	2	LS-MASSE-4FG
900 mm	4640 g	47,94	2	LS-MASSE-4

Fibra de vidrio

### Maza con mango en fibra de vidrio



#### LS-MASSE-TR

L	g	€	Icon	Icon
900 mm	4840 g	65,08	2	LS-MASSE-TR-4FG

### Mango de repuesto para hachas



#### SH

L	€	Icon	Icon
800 mm	27,87	1	SH-FCS-810
900 mm	32,00	1	SH-FCS-860
600 mm	22,08	1	SH-FGS-600
700 mm	24,10	12	SH-FGS-700
800 mm	28,71	1	SH-FGS-800
900 mm	20,83	1	SH-FGS-1.8-810
375 mm	19,91	1	SH-HFGPS-400FG
400 mm	17,66	1	SH-HGPS-400
900 mm	21,52	12	SH-MES-F-900
360 mm	14,92	12	SH-HGPS-360
380 mm	16,01	1	SH-HGPS-380
380 mm	16,01	1	SH-HUS-380
500 mm	21,00	1	SH-HUS-500
650 mm	23,74	1	SH-HUS-650
900 mm	27,62	12	SH-MES-900
915 mm	41,35	12	SH-MES-900FG
800 mm	28,71	12	SH-SUS-800
800 mm	28,71	1	SH-MCS-800
905 mm	34,64	1	SH-FCP-860

FB: Fibra Vidrio

### Hacha



#### LS/MES

L	g	€	Icon	Icon
900 mm	3390 g	50,79	2	LS-MERLIN-2.5
900 mm	3330 g	65,56	2	LS-MERLIN-2.5FG
900 mm	3580 g	55,39	2	MES-3.0-900

FG: Fibra de vidrio

### Hacha rompedora



#### MES

L	g	€	Icon	Icon
900 mm	4250 g	61,78	2	MES-3.5-900
900 mm	4310 g	79,39	2	MES-3.5-900FG

Fibra de vidrio

### Pico de hacha



#### PAGO-2.0-900FG

L	g	€	Icon	Icon
900 mm	3000 g	77,22	1	PAGO-2.0-900FG

### Cabeza para pico



#### PAGO

L	g	€	Icon	Icon
520 mm	2000 g	32,13	1	PAGO-2.0

### Mangos de repuesto para pico de hacha



#### SH-PAGO

L	g	€	Icon	Icon
900 mm	690 g	21,19	1	SH-PAGO-900
920 mm	1030 g	49,02	1	SH-PAGO-900FG

Fibra de vidrio

## CUÑAS

### Cuñas de Tumba



#### LS-COIN

L	g	€	Icon	Icon
260 mm	295 g	32,43	2	LS-COIN 26 CM
190 mm	170 g	30,19	4	LS-COIN 19 CM

### Cuñas rompedoras



#### WT

L	g	€	Icon	Icon
220 mm	2000 g	59,68	4	WT-2.0

### Cuñas rompedoras



#### WS

L	g	€	Icon	Icon
220 mm	1500 g	20,73	4	W-S-1.5
250 mm	2000 g	26,42	4	W-S-2.0
260 mm	2500 g	32,78	4	W-S-2.5





**BAHCO®**



## Cinceles y punteros de chapista



## CINCELES DE CHAPISTA

Cinceles de chapista con mango octogonal y revestimiento de plástico



### 3656

L	W	€	PK	PK
129 mm	12 mm	9,88	50	3656-125
155 mm	16 mm	13,95	50	3656-150
178 mm	19.5 mm	9,88	1	3656-175

## Cortafíos plano



### 3640

L	W	€	PK	PK
150 mm	18 mm	16,93	25	3640-150-C
175 mm	21 mm	14,63	6	3640-175-C*
200 mm	22 mm	19,51	25	3640-200-C
250 mm	28 mm	23,15	20	3640-250-C
300 mm	26 mm	29,66	25	3640-300-C

## Buril



### 3745

L	W	€	PK	PK
150 mm	6 mm	14,05	50	3745-150
175 mm	7 mm	17,95	25	3745-175
200 mm	8 mm	19,04	20	3745-200
250 mm	9 mm	26,83	10	3745-250

## Cortafíos plano



### 3740

L	€	PK	PK
100 mm	9,45	50	3740-100
125 mm	11,38	50	3740-125
150 mm	13,01	50	3740-150
175 mm	13,77	25	3740-175
200 mm	14,94	25	3740-200
250 mm	15,72	10	3740-250
300 mm	16,81	10	3740-300

## Cinzel con cabeza reforzada



### 3756

L	W	€	PK	PK
125 mm	10 mm	7,06	50	3756-125
150 mm	12 mm	8,76	50	3756-150

## Cinzel con vástago octogonal



### 3749

L	W	€	PK	PK
125 mm	10 mm	7,06	50	3749-125

## Cortafíos plano con clip para colgar



### SB-3740

L	€	PK	PK
125 mm	11,87	87	SB-3740-125
150 mm	13,50	25	SB-3740-150
175 mm	15,11	25	SB-3740-175
200 mm	15,73	25	SB-3740-200
250 mm	16,59	25	SB-3740-250
300 mm	17,42	25	SB-3740-300

## Buriles con mango octogonal plano y revestimiento de plástico



### 3649

L	W	€	PK	PK
128 mm	12 mm	9,88	50	3649-125

## Cortafíos para grietas



### 3750

L	W	€	PK	PK
240 mm	26 mm	18,61	25	3750



Cinzel de albañil



**3736M**

L	€		
200 mm	16,25	30	3736M-200
250 mm	21,36	25	3736M-250
300 mm	28,31	10	3736M-300
400 mm	37,34	10	3736M-400

Cinzel



**8740**

L	€		
200 mm	10,26	5	874002000
250 mm	11,24	5	874002500
300 mm	12,68	5	874003000
350 mm	14,05	5	874003500
400 mm	17,66	5	874004000
500 mm	21,06	5	874005000

Juego de 6 buriles



**3736S/6**

g	€		
840 g	62,18	5	3736S/6

3735-4-120, 3735-5-150

3733-3

3749-125

3756-125, 3756-150

Cinzel de punta



**3739-250 / -400**

L	Ø	€		
250 mm	16 mm	21,47	25	3739-250
300 mm	18 mm	28,43	10	3739-300
400 mm	18 mm	37,54	10	3739-400

Cinzel de punta con cabeza reforzada



**3739H**

L	Ø	€		
250 mm	16 mm	29,60	15	3739H-250
300 mm	18 mm	36,38	10	3739H-300
400 mm	18 mm	45,51	10	3739H-400

**CINCELES DE CHAPISTA CON PROTECCION**

Cortafíos con cabeza reforzada



**3750H**

L	€		
240 mm	27,11	25	3750H

**CINCELES DE CHAPISTA (REAFILABLES)**

Cortafíos



**8741**

L	€		
200 mm	16,44	6	874102000
250 mm	17,30	5	874102500
300 mm	18,49	5	874103000
350 mm	19,78	4	874103500
400 mm	22,63	5	874104000

Cinzel de albañil con cabeza reforzada



**3736MH**

L	€		
250 mm	29,44	10	3736MH-250
300 mm	36,18	10	3736MH-300
400 mm	45,28	5	3736MH-400

Puntero Octogonal



**8746**

L	Ø	€		
200 mm	14 mm	8,59	5	874602000
250 mm	14 mm	9,54	5	874602500
300 mm	16 mm	10,72	5	874603000
350 mm	16 mm	12,20	5	874603500
400 mm	18 mm	14,60	5	874604000

\* Hasta agotar existencias



Cinzel de electricista



**8760**

L	€			
200 mm	9,25	10	876002000	
250 mm	9,65	5	876002500	

Cinzel de chapista



**8770**

L	€			
240 mm	16,86	25	877002400	

**CINCELES DE CHAPISTA - ACCESORIOS**

Mango para formones



**8749**

Ø	€			
16x16 mm	5,47	1	874916X16	
18x18 mm	5,47	1	874918X18	
23x13 mm	5,47	1	874923X13	
26x7 mm	5,47	1	874926X7	

**PUNTEROS**

Granete con protector para la mano



**3643**

Ø	L	€			
3 mm	100 mm	18,43	50	3643-100	
4 mm	120 mm	20,74	50	3643-120	
5 mm	120 mm	26,52	50	3643-150	

Granete color cobre, mango octogonal



**3735**

Ø	L	€			
4 mm	120 mm	5,48	50	3735-4-120	
5 mm	120 mm	6,76	50	3735-5-120	
5 mm	150 mm	8,99	50	3735-5-150	

Granete con mango hexagonal



**3735N**

Ø	L	€			
2 mm	100 mm	5,71	10	3735N-2-100	
4 mm	120 mm	6,34	10	3735N-4-120	
5 mm	120 mm	7,17	10	3735N-5-120	
6 mm	150 mm	7,80	10	3735N-6-150	
8 mm	150 mm	7,80	10	3735N-8-150	
2 mm	100 mm	6,52	1	SB-3735N-2-100	
4 mm	120 mm	7,14	60	SB-3735N-4-120	
5 mm	120 mm	7,97	1	SB-3735N-5-120	
6 mm	150 mm	8,61	1	SB-3735N-6-150	
8 mm	150 mm	8,61	1	SB-3735N-8-150	

SB: Clip para colgar

Juego de 4 granetes cromados



**3735NS/4**

g	€			
340 g	28,45	25	3735NS/4	

3735N-6-150, 3735N-8-150, 3735N-2-100, 3735N-4-120

Punzón automático



**1157**

Ø	L	€			
2 mm	130 mm	14,23	60	1157	

Botador con protector para la mano



**3644**

Ø	L	€			
2 mm	120 mm	15,45	50	3644-120	
3 mm	125 mm	18,23	50	3644-125	
4 mm	130 mm	22,04	50	3644-130	
4 mm	150 mm	23,70	50	3644-150	
5 mm	165 mm	24,43	50	3644-165	
6 mm	180 mm	32,65	50	3644-180	
8 mm	200 mm	37,01	50	3644-200	

Botador con manguito guía



**3659**

Ø	L	€	📦	🐟
0.9 mm	70 mm	12,49	5	3659-0.9
1.4 mm	81 mm	12,72	5	3659-1.4
1.8 mm	84 mm	13,08	5	3659-1.8
2.4 mm	92 mm	14,06	5	3659-2.4
2.8 mm	95 mm	14,82	5	3659-2.8
3.4 mm	97 mm	15,13	5	3659-3.4
3.9 mm	100 mm	13,95	5	3659-3.9
5.9 mm	100 mm	15,41	5	3659-6.0

Botador cónico color cobre mango octogonal



**3733**

Ø	L	€	📦	🐟
2 mm	120 mm	5,20	50	3733-2
3 mm	120 mm	5,20	50	3733-3
4 mm	120 mm	5,10	50	3733-4
5 mm	120 mm	5,10	50	3733-5
6 mm	120 mm	5,10	50	3733-6

Botador con protector para la mano



**3646**

Ø	L	€	📦	🐟
2 mm	115 mm	18,43	250	3646-115
3 mm	125 mm	18,43	250	3646-125
4 mm	150 mm	18,51	125	3646-150
5 mm	165 mm	18,68	125	3646-165
6 mm	180 mm	21,37	50	3646-180
8 mm	200 mm	25,67	50	3646-200

Botador con protector para la mano



**3658A**

Ø	L	€	📦	🐟
2 mm	150 mm	18,72	125	3658A-2
3 mm	150 mm	18,91	125	3658A-3
4 mm	150 mm	18,91	125	3658A-4
5 mm	150 mm	18,98	125	3658A-5
6 mm	150 mm	18,98	125	3658A-6
8 mm	150 mm	18,98	50	3658A-8

Botador cilíndrico color cobre mango octogonal



**3734**

Ø	L	€	📦	🐟
2 mm	150 mm	8,80	50	3734-2
3 mm	150 mm	8,80	50	3734-3
4 mm	150 mm	8,80	50	3734-4
5 mm	150 mm	8,80	50	3734-5
6 mm	150 mm	8,80	50	3734-6
8 mm	150 mm	8,99	50	3734-8

Botador cilíndrico mango hexagonal



**3734N**

Ø	L	€	📦	🐟
2 mm	150 mm	6,32	10	3734N-2-150
3 mm	150 mm	6,32	10	3734N-3-150
4 mm	150 mm	6,53	10	3734N-4-150
5 mm	150 mm	6,53	10	3734N-5-150
6 mm	150 mm	7,80	10	3734N-6-150
7 mm	150 mm	7,80	10	3734N-7-150

Ø	L	€	📦	🐟
8 mm	150 mm	7,80	10	3734N-8-150
9 mm	150 mm	7,80	10	3734N-9-150
10 mm	150 mm	7,80	10	3734N-10-150
2 mm	150 mm	7,13	1	SB-3734N-2-150
3 mm	150 mm	7,13	1	SB-3734N-3-150
4 mm	150 mm	7,33	60	SB-3734N-4-150
5 mm	150 mm	7,33	1	SB-3734N-5-150
6 mm	150 mm	8,61	60	SB-3734N-6-150
7 mm	150 mm	8,61	1	SB-3734N-7-150
8 mm	150 mm	8,61	1	SB-3734N-8-150
10 mm	150 mm	8,61	1	SB-3734N-10-150

Juego de 6 botadores con protector para la mano



**3646/6**

g	€	📦	🐟
730 g	147,10	25	3646/6

3646-115, 3646-125, 3646-150, 3646-165, 3646-180, 3646-200

Juego de herramientas, 6 piezas



**3654R**

g	€	📦	🐟
870 g	163,22	1	3654R

2 x 3656, 1 x 3649, 2 x 3644, 1 x 3643



Juego de 8 botadores



**3659/8**

<b>g</b>	€		
270 g	117,19	1	3659/8

3659-0.9, 3659-1.4, 3659-1.8, 3659-2.4, 3659-2.8, 3659-3.4, 3659-3.9, 3659-6.0

Juego de 6 botadores con protector para la mano



**3658A/6**

<b>g</b>	€		
560 g	139,87	30	3658A/6

3658A-2, 3658A-3, 3658A-4, 3658A-5, 3658A-6, 3658A-8

Juego de 9 botadores cilíndricos 2-10mm



**3734NS/9**

<b>g</b>	€		
750 g	64,02	10	3734NS/9

3734N-10-150, 3734N-9-150, 3734N-8-150, 3734N-7-150, 3734N-6-150, 3734N-5-150, 3734N-4-150, 3734N-3-150, 3734N-2-150

Juego de 6 botadores



**3734S/6**

<b>g</b>	€		
720 g	69,24	5	3734S/6

3734-2, 3734-3, 3734-4, 3734-5, 3734-6, 3734-8

Juego de 8 botadores en estuche de plástico



**3659/8T**

<b>g</b>	€		
170 g	112,12	1	3659/8T

3659-0.9, 3659-2.8, 3659-2.4, 3659-1.8, 3659-6.0, 3659-3.9, 3659-3.4, 3659-1.4

Botador con protector para la mano en blister



**3732**

		€		
2 mm	125 mm	6,12	60	SB-3732-2-125
2.5 mm	125 mm	6,12	60	SB-3732-2.5-125
3.2 mm	125 mm	6,12	60	SB-3732-3.2-125
4 mm	125 mm	6,12	1	SB-3732-4-125

Juego de herramientas, 10 piezas



**3656/10**

<b>g</b>	€		
1260 g	269,88	1	3656/10

3 x 3656, 1 x 3644, 1 x 3649, 1 x 3643 en 3 x 3646

Juego de 5 botadores cónicos dorados



**3733S/5**

<b>g</b>	€		
410 g	27,61	25	3733S/5

3733-4, 3733-2, 3733-6  
3733-8, 3733-10

Sacabocados



**B400**

	€		
2 mm	11,67	1	B400.002
3 mm	11,67	1	B400.003
4 mm	11,67	1	B400.004
5 mm	11,67	1	B400.005

Ø	€	g	WPH
6 mm	11,67	1	B400.006
7 mm	11,67	1	B400.007
8 mm	11,67	1	B400.008
9 mm	11,67	1	B400.009
10 mm	11,67	1	B400.010
11 mm	14,69	1	B400.011
12 mm	14,69	1	B400.012
13 mm	14,69	1	B400.013
14 mm	14,69	1	B400.014
15 mm	14,69	1	B400.015
16 mm	14,69	1	B400.016
17 mm	14,69	1	B400.017
18 mm	14,69	1	B400.018
19 mm	14,69	1	B400.019
20 mm	14,69	1	B400.020
21 mm	19,47	1	B400.021
22 mm	19,47	1	B400.022
23 mm	19,47	1	B400.023
24 mm	19,47	1	B400.024
25 mm	19,47	1	B400.025
26 mm	19,47	1	B400.026
27 mm	19,47	1	B400.027
28 mm	19,47	1	B400.028
29 mm	19,47	1	B400.029
30 mm	19,47	1	B400.030
31 mm	25,14	1	B400.031
32 mm	25,14	1	B400.032
33 mm	25,14	1	B400.033
34 mm	25,14	1	B400.034
35 mm	25,14	1	B400.035
36 mm	25,14	1	B400.036
37 mm	25,14	1	B400.037
38 mm	25,14	1	B400.038
39 mm	25,14	1	B400.039
40 mm	25,14	1	B400.040
41 mm	29,57	1	B400.041
42 mm	29,57	1	B400.042
43 mm	29,57	1	B400.043
44 mm	29,57	1	B400.044
45 mm	29,57	1	B400.045
46 mm	29,57	1	B400.046
47 mm	29,57	1	B400.047
48 mm	29,57	1	B400.048
49 mm	29,57	1	B400.049
50 mm	29,57	1	B400.050

### Tapón sacabocados mango 2 a 30 mm



#### WPH3-30

L	g	€	WPH
185 mm	500 g	46,05	1 WPH 3-30

### Tapón sacabocados mango 2 a 50 mm



#### WPH2-50

L	g	€	WPH
180 mm	761 g	141,10	1 WPH 2-50

### Juego sacabocados, 11 piezas



### Juego sacabocados, 16 piezas



#### 400.003.030

Ø	€	WPH
3-30 mm		1 400.003.030

### Juego punzones 2 a 50 mm



#### 400.002.050

Ø	€	WPH
2-50 mm		1 400.002.050

### Tapón sacabocados mango 2 a 20 mm



#### WPH3-20

L	g	€	WPH
95 mm	290 g	34,29	1 WPH 3-20

### 400.003.020

Ø	€	WPH
3-20 mm		1 400.003.020



### Sacabocados revólver



#### 2635

L	€	WPH
245 mm	62,46	1 2635





Sacabocados revólver



**4630**

	€		
220 mm	24,31	1	4630

Perforador de chapa métrico redondo



**6900**

	€		
16 mm	62,46	1	690000160
20 mm	78,30	1	690000200
22 mm	78,30	1	690000220
25 mm	88,92	1	690000250
30 mm	96,25	1	690000300
32 mm	96,25	1	690000320
35 mm	123,26	1	690000350
40 mm	132,14	1	690000400
50 mm	162,15	1	690000500
63 mm	375,84	1	690000630

Juego 7 perforadores chapa



**6907**

	€		
4080 g	1.016,28	1	69079019P

- 690000160, 690000250, 690000200, 690000320, 690000500, 690000400, 690000630
- 690900120, 690900080, 690900100, 690900200, 690900140

Tornillos de repuesto para perforadores de chapa



**6909**

	€		
16 mm	13,04	4	690900080
20-25 mm	19,25	4	690900100
30-35 mm	19,25	2	690900120
40-50 mm	28,72	2	690900140
63 mm	56,74	1	690900200

PUNTEROS CON MANGO BIMATERIAL

Granete con punta



**SB3755BM**

		€		
4 mm	165 mm	10,60	1	SB3755BM-4
6 mm	185 mm	11,79	5	SB3755BM-6

SB: Embalaje en blister

Granete cilíndrico



**SB3734BM**

		€		
3 mm	155 mm	13,06	5	SB3734BM-3
4 mm	165 mm	13,42	5	SB3734BM-4
5 mm	165 mm	13,83	5	SB3734BM-5
6 mm	185 mm	14,26	5	SB3734BM-6
8 mm	185 mm	14,52	5	SB3734BM-8
10 mm	185 mm	14,96	5	SB3734BM-10

SB: Embalaje en blister

Bandeja modular 7 botadores cilíndricos



**3734BMS/7**

	€		
900 g	100,33	1	3734BMS/7

CINCELES DE CHAPISTA CON MANGO BIMATERIAL

Cinzel con protector 15mm



**SB3654BM**

	€		
155 mm	14,38	5	SB3654BM-15
185 mm	15,27	5	SB3654BM-20

SB: Embalaje en blister

Bandeja modular con 7 cinceles



**3654BMS/7**

	€		
920 g	102,95	1	3654BMS/7

3734BM-2, 3734BM-4, 3734BM-5, 3734BM-6, 3654BM-15, 3654BM-20, 3755BM-6



## Palanca desencofrar



## BARRAS DESECOFRADORAS

Palanca ajustable de 260 mm



### APB260

L	g	€	Icon	Icon	Code
260 mm	410 g	63,98	Icon	Icon	APB260*

Palanca Crowfoot de 330 mm con extremo preciso (Display con 12 piezas)



### CFP250-DISP

Icon	Icon	€	Icon	Icon	Code
12	50 x 280 x 330 mm	25,94	Icon	Icon	CFP250-DISP*

12x CFP250

CFP250x 12

Palanca ajustable de 360 mm



### APB360

L	g	€	Icon	Icon	Code
360 mm	543 g	64,65	Icon	Icon	APB360*

Barra desengofadora premium



### WBP

Icon	L	€	Icon	Icon	Code
14 mm	346 mm	38,66	Icon	Icon	WBP300
16 mm	487 mm	42,65	Icon	Icon	WBP500
17 mm	625 mm	55,99	Icon	Icon	WBP625
17 mm	704 mm	62,64	Icon	Icon	WBP710
20 mm	890 mm	91,98	Icon	Icon	WBP900

Palanca Crowfoot - Acabado preciso 10"



### CFP250

L	€	Icon	Icon	Code
250 mm	24,49	Icon	Icon	6 CFP250

Barra desengofadora



### WBB

L	Icon	€	Icon	Icon	Code
391 mm	14 mm	19,99	Icon	Icon	10 WBB400
500 mm	16 mm	21,33	Icon	Icon	10 WBB500
595 mm	18 mm	22,66	Icon	Icon	10 WBB600
680 mm	18 mm	24,66	Icon	Icon	6 WBB700

L	Icon	€	Icon	Icon	Code
810 mm	18 mm	28,00	Icon	Icon	6 WBB800
1000 mm	20 mm	42,80	Icon	Icon	4 WBB1000
1200 mm	20 mm	49,52	Icon	Icon	4 WBB1200
1500 mm	22 mm	66,00	Icon	Icon	4 WBB1500

Barra desengofadora plana



### WBF380

L	Icon	€	Icon	Icon	Code
374 mm	35 mm	21,33	Icon	Icon	12 WBF380

Mini palanca plana



### WBMF190

Icon	L	€	Icon	Icon	Code
18 mm	188 mm	10,60	Icon	Icon	24 WBMF190

Display con 15 barras desengofadoras WBMF190



### WBMF190IP

g	€	Icon	Icon	Code
39 g	10,94	Icon	Icon	15 WBMF190IP

WBMF190x 15

Juego 3 palancas premium: WBP625,  
WBF380 y WBMF190



**WBP-3P-6FMF**

<b>g</b>	<b>€</b>		
3000 g	79,31	1	WBP-3P-6FMF

WBP625	
WBF380	
WBMF190	

Juego de 3 palancas premium octogonales  
para mayor fuerza



**WBP-3P-96F**

<b>g</b>	<b>€</b>		
6000 g	152,53	1	WBP-3P-96F

WBP900, WBP625	
WBF380	

\* Hasta agotar existencias





**BAHCO®**





## Herramientas para plantación y cultivo



**PEQUEÑAS HERRAMIENTAS DE JARDINERÍA**

Azada 



**P262**  
 315 mm    € 16,81    10 P262

Azuela 



**P272**  
 450 mm    € 21,50    5 P272

Lanza Azuela 



**P268**  
 320 mm    € 17,42    10 P268

Lanza azuela 



**P278**  
 455 mm    € 21,79    5 P278

Azada horquilla 



**P267**  
 320 mm    € 17,42    10 P267

Azuela horquilla 



**P277**  
 455 mm    € 21,93    5 P277

Transplantador 



**P263**  
 370 mm    € 18,91    10 P263

Cultivador 



**P264**  
 315 mm    € 16,94    10 P264

Cultivador 



**P274**  
 470 mm    € 20,89    5 P274

Rastrillo



**P276**



450 mm

€

21,43



5



P276

Tridente



**P270**



305 mm

€

16,24



10



P270

Rastrillo



**P266**



335 mm

€

16,74



10



P266

Plantador de bulbos



**P241**



340 g

€

13,06



5



P241

Escarvador



**P269**



315 mm

€

13,68



10



P269



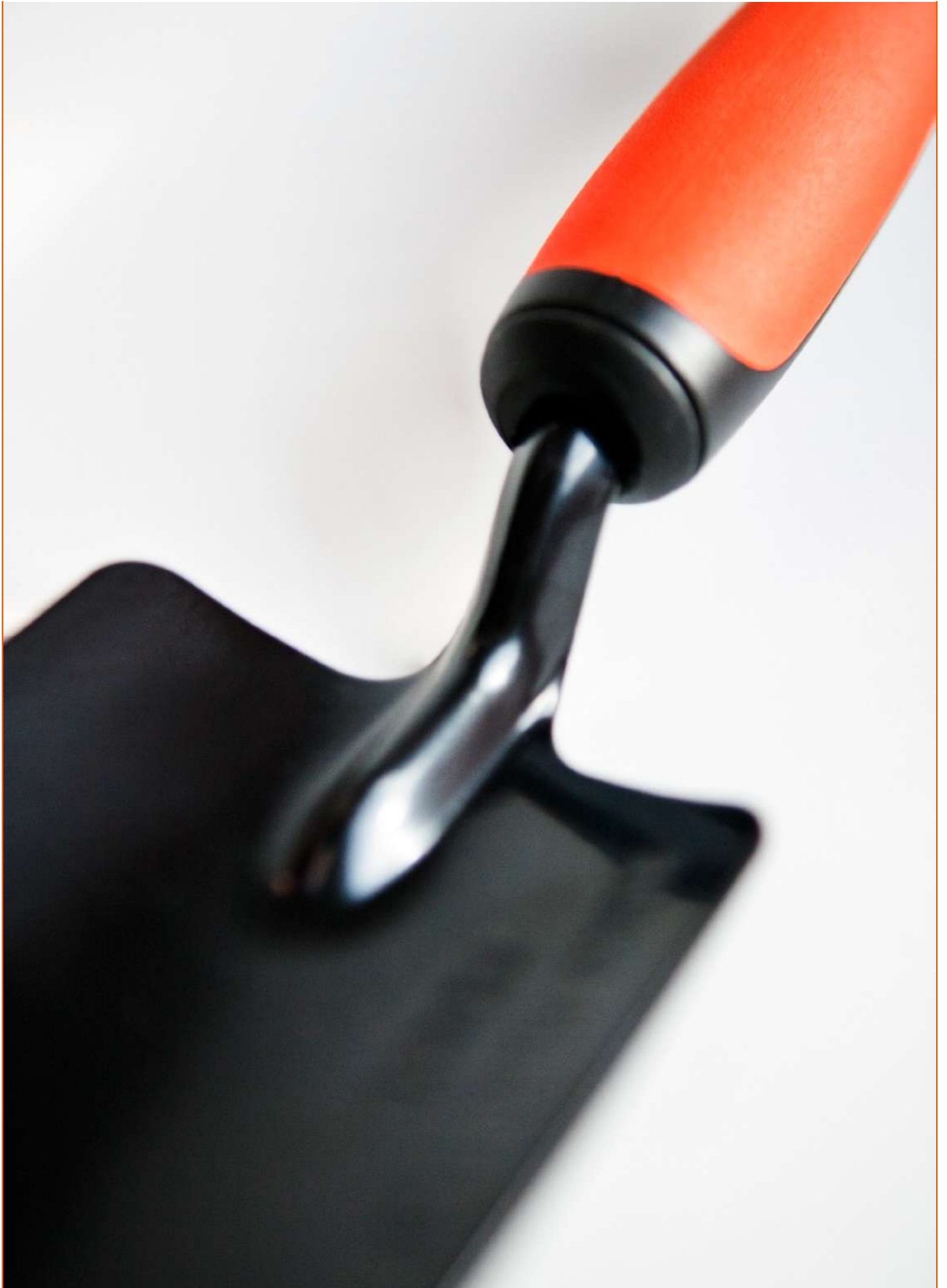

**BAHCO®**



## Herramientas de Poda





## TIJERAS DE PODAR DE UNA MANO

Podadera ergonómica de mango fijo

ergo



PX

	€		
15 mm	58,20	2	PX-S1
20 mm	58,20	2	PX-S2
15 mm	58,20	2	PX-M1
20 mm	58,20	2	PX-M2
20 mm	58,20	2	PX-M2-L
30 mm	58,20	2	PX-M3
20 mm	58,20	2	PX-L2
30 mm	58,20	2	PX-L3

L: Zurdos

Podadera ergonómica de mango rotativo

ergo

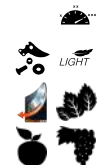

PXR

	€		
20 mm	84,26	2	PXR-S2-L
15 mm	84,26	2	PXR-S1
20 mm	84,26	2	PXR-S2
15 mm	84,26	2	PXR-M1
20 mm	84,26	2	PXR-M2
20 mm	84,26	2	PXR-M2-L
30 mm	84,26	2	PXR-M3
20 mm	84,26	2	PXR-L2

L: Zurdos

Cabeza de corte pre-ensamblada para PX-PXR



R801P-R804P

	€		
1	39,22	1	R801P
2	39,52	1	R802P
3	39,61	1	R803P
2	34,30	1	R804P

Recambio de hoja para podadera



R211P/R300P/R500P/R600P

	€		
Px/PxR N° 2, P1-20, P2-20	20,66	1	R211P
Px/PxR N° 2, P1-20, P2-20	19,23	80	R211P-BULK80
Px/PxR N° 1	20,29	1	R300P
Px/PxR N° 3	20,37	40	R500P
Px-M2-L & PxR-M2-L	20,20	1	R600P

Recambio de contra-hoja para PX/PXR



R303P-R603P

	€		
Px-S1, Px-M1, Px-L1, PxR-M1, PxR-L1	21,66	1	R303P
Px-S2, Px-M2, Px-L2, PxR-M2, PxR-L2	21,89	1	R403P
Px-S3, Px-M3, Px-L3, PxR-M3, PxR-L3	19,86	1	R503P
Px-M2-L, PxR-M2-L	19,33	1	R603P

Recambio de mangos para podaderas PX/PXR



ergo



R811P-RT825P

	€		
Px-S	26,78	1	R811P
Px-M	25,33	1	R812P
Px-L	25,34	1	R813P
Px-M2-L	26,43	1	R815P
PxR-S	51,42	1	RT821P
PxR-M	49,33	1	RT822P
PxR-L	56,75	6	RT823P
PxR-M2-L	67,29	1	RT824P
PXR-S2-L	51,44	6	RT825P

Recambio del perno central para podadera ERGO™



R900P

	g	€		
PX & PXR	20 g	8,24	1	R900P

Recambio del bloqueo del perno central



R901P

	g	€		
PX & PXR	10 g	7,39	30	R901P

Juego de recambio de 4 tornillos para PX/  
PXR



**R902P**

Icono	g	€	Paquete	Modelo
PX & PXR	20 g	6,64	24	R902P

Recambio muelles



**R905P-R907P**

Icono	g	€	Paquete	Modelo
PX & PXR, P64	10 g	6,05	1	R905P
PX & PXR, P64	164 g	2,39	50	R905P-BULK50
PX & PXR	10 g	6,05	1	R906P
PX & PXR	220 g	2,53	50	R906P-BULK50
PX & PXR	10 g	6,28	1	R907P

Dureza: R905P (blanda) R906P (media) R907P (dura)

Podadera una mano con mango de  
composite



**P1**

Icono	L	€	Paquete	Modelo
	20 mm	200 mm	43,63	5 P1-20
	30 mm	230 mm	49,09	5 P1-23

Repuestos disponibles

Recambio de 2 topos de goma para  
podaderas PX/PXR



**R903P/R1269P**

Icono	g	€	Paquete	Modelo
PX & PXR, P1 & P2, P64	10 g	5,42	1	R903P
PX & PXR, P1 & P2, P64	486 g	1,41	50	R1269P-BULK50

Podadera de una mano, forjada



**P3**

Icono	L	€	Paquete	Modelo
	20 mm	62,68	2	P3-20-F
	25 mm	65,14	2	P3-23-F

Podadera de una mano



**P108**

Icono	L	€	Paquete	Modelo
	20 mm	200 mm	32,77	2 P108-20-F
	25 mm	230 mm	37,46	2 P108-23-F

Recambio del cierre para podaderas PX/  
PXR



**R904P**

Icono	g	€	Paquete	Modelo
Px & Pxr	10 g	7,58	1	R904P

Podadera de una mano



**P110**

Icono	L	€	Paquete	Modelo
	20 mm	31,60	2	P110-20-F
	25 mm	35,82	2	P110-23-F

Podadera de una mano, forjada



**P5**

Icono	L	€	Paquete	Modelo
	25 mm	230 mm	73,28	2 P5-23-F



Podadera de una mano



**P138**

Blade Length	Handle Length	Price (€)	Quantity	Product Code
20 mm	220 mm	30,77	6	P138-22-BULK6
20 mm	220 mm	44,26	6	P138-22-F

Podadera de una mano



**P121**

Blade Length	Handle Length	Price (€)	Quantity	Product Code
15 mm	180 mm	24,00	6	P121-18-F
20 mm	200 mm	25,16	6	P121-20-F
25 mm	230 mm	26,34	6	P121-23-F

Recambio del yunque de aluminio con remache



**R221P/R222P**

Product Code	Price (€)	Quantity	Product Code
P138-22	7,69	1	R221P
P138-22	5,84	50	R221P-BULK50

Tijeras para recolección de rosas



**P64**

Blade Length	Handle Length	Price (€)	Quantity	Product Code
12 mm	210 mm	40,87	12	P64-20-BULK12

Podadera de una mano



**P126**

Blade Length	Handle Length	Price (€)	Quantity	Product Code
15 mm	190 mm	18,02	6	P126-19-F
20 mm	220 mm	23,18	6	P126-22-F

Recambio de hoja para P1 y P2



**R201P/R171P**

Product Code	Price (€)	Quantity	Product Code
P1-22, P2-22	21,61	1	R201P
P1-22, P2-22	12,82	80	R201P-BULK80

Podadera para trabajos de mantenimiento jardín



**PG-01-F/PG-03-L**

Blade Length	Price (€)	Quantity	Product Code
12-20 mm	32,63	6	PG-01-F
12-20 mm	33,66	2	PG-03-L

PG-01-F: Diestros PG-03-L: Zurdos

Tijeras de poda de una mano



**PG-12-F**

Blade Length	Handle Length	Price (€)	Quantity	Product Code
20 mm	210 mm	15,51	10	PG-12-F
20 mm	210 mm	14,39	15	PG-12-BULK15

Hojas de repuesto para tijeras de podar de una mano de corte deslizante P4



**R301P**

Product Code	Weight (g)	Price (€)	Quantity	Product Code
P4-20, P4R-20	41 g	21,91	30	R301P

Recambios de hoja con pasador para podaderas una mano y de pértiga



### R112PG-R124PG/R224P

Icono	€	Paquete	Modelo
P3-20, P5-20	17,46	1	R112PG
P108-20, P110-20	17,65	1	R114PG
P3-23, P5-23	18,54	30	R122PG
P108-23, P110-23, P34-27A	18,84	30	R124PG
P138-22	21,02	1	R223P
P138-22	17,51	80	R223P-BULK80

Recambio de contra-hoja para podaderas una mano



### R202P/R271P

Icono	€	Paquete	Modelo
P1-22, P2-22	22,20	1	R202P

Repuesto de contrahoja para podaderas de una mano de corte deslizante P4



### R304P

Icono	g	€	Paquete	Modelo
P4-20, P4R-20	45 g	25,30	1	R304P

Pernos centrales de repuesto para podaderas de una mano de corte deslizante P4



### R900P-Z

Icono	g	€	Paquete	Modelo
P4-20, P4-23, P4R-20, P4R-23	21 g	9,04	24	R900P-Z

Muelle de repuesto para podaderas de una mano de corte deslizante P4

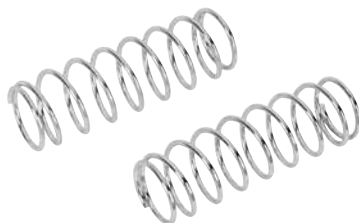

### R906P-Z

Icono	g	€	Paquete	Modelo
P4-20, P4-23, P4R-20, P4R-23	8 g	7,09	12	R906P-Z

Perno completo para podaderas de una mano



### R239P/R141P/R142P/R157H

Icono	€	Paquete	Modelo
P34-27A, P3-20, P3-23, P5-20, P5-23, P108-20, P108-23, P110-20, P110-23	7,94	24	R142P
P121-23	16,08	1	R148V
P1-20, P1-22, P2-20, P2-22, P6-20, P7-20	8,76	1	R239P

Recambios de contra-hoja y pasador



### R113PG/R123PG

Icono	€	Paquete	Modelo
P108-20, P110-20	18,84	30	R113PG
P108-23, P110-23	18,65	30	R123PG

Recambio de cierre



### R341P/R474P

Icono	€	Paquete	Modelo
P3-20, P3-23	5,20	12	R341P
P5-20, P5-23, P108-20, P108-23, P110-20, P110-23	5,03	1	R474P

Recambio de muelles para podaderas de una mano



### R438P/R463P

Icono	€	Paquete	Modelo
P121-20	6,87	1	R434P
P121-20	1,99	50	R434P-BULK50
P121-23	7,60	1	R463P
P138-22	6,50	1	R438P
P138-22	2,00	50	R438P-BULK50



Recambio de muelle y tope para podaderas de una mano



**R1069P**

	€		
P1-20, P2-20, P6-20, P7-20	5,46	12	R1069P

Recambio de tornillos, tuerca y cierre para los mangos



**R1601**

	€		
P1-20, P1-22, P2-20, P6-20, P7-20	8,55	1	R1601

Tijera de vendimia y recolección



**P127**

	€			
6 mm	11,60	30	P127-19-BULK30	

Recambio de muelle, tope de goma y tope metálico



**R1068**

	€		
P3-20, P3-23, P5-20, P5-23, P108-20, P108-23, P110-20, P110-23	6,49	1	R1068

Sistema de cierre con tornillo y tuerca



**R478P/R480P**

	€		
P108	9,27	1	R478P
P5	7,50	1	R480P

Tijera de vendimia y recolección



**P128**

	€			
6 mm	15,12	6	P128-19	
6 mm	11,91	30	P128-19-BULK30	

**HERRAMIENTAS PARA RECOGIDA DE FRUTA**

Recambios para P5-20 y P-23



**R1080P**

	€		
P5-20, P5-23	6,41	1	R1080P

Tijera de vendimia y recolección



**P123**

	€			
10 mm	11,79	30	P123-19-BULK30	

Tijera de vendimia y recolección



**P129**

	€			
6 mm	12,93	30	P129-19-BULK30	



## Recambios de muelles y topes



### R1071/R1075

Icon	g	€	Icon	Icon
P123, P127, P128, P129	20 g	10,96	14	R1071
P123, P127, P128, P129	130 g	1,10	50	R1075-BULK50

## Podadera de dos manos



### P16-40W

Icon	L	€	Icon	Icon
30 mm	400 mm	78,19	2	P16-40W

## Podadera de dos manos



### P19

Icon	L	€	Icon	Icon
50 mm	800 mm	172,76	1	P19-80-F

## TIJERAS DE PODAR DE DOS MANOS

### Podadora super ligera



### P114-SL

Icon	L	€	Icon	Icon
30 mm	400 mm	78,56	2	P114-SL-40
30 mm	500 mm	80,19	2	P114-SL-50
30 mm	600 mm	87,32	2	P114-SL-60

### Podadora super ligera



### P116-SL

Icon	L	€	Icon	Icon
35 mm	400 mm	90,60	2	P116-SL-40
35 mm	500 mm	94,87	2	P116-SL-50
35 mm	600 mm	97,83	2	P116-SL-60
35 mm	700 mm	100,84	2	P116-SL-70

### Podadera de corte deslizante y multiplicador



### P280-SL

Icon	L	€	Icon	Icon
55 mm	600 mm	69,94	2	P280-SL-60
55 mm	800 mm	76,09	2	P280-SL-80

### Podadera de dos manos



### P16

Icon	L	€	Icon	Icon
30 mm	400 mm	78,37	2	P16-40
30 mm	500 mm	94,66	2	P16-50-F
30 mm	600 mm	97,82	2	P16-60-F

### Podadora super ligera



### P160-SL

Icon	L	€	Icon	Icon
45 mm	600 mm	105,52	2	P160-SL-60
45 mm	750 mm	111,89	1	P160-SL-75
45 mm	900 mm	119,74	1	P160-SL-90

### Podadera tipo cizalla con sistema multiplicador



### P173-SL

Icon	L	€	Icon	Icon
45 mm	850 mm	109,22	1	P173-SL-85



Tijera de podar de dos manos



**P130-P140**

Ø	L	€	Icon	Icon	Code
40 mm	450 mm	37,16			P130-F
40 mm	660 mm	47,14			P140-F

Podadera ligera de dos manos



**PG-18**

Ø	L	€	Icon	Icon	Code
40 mm	450 mm	40,96			PG-18-45-F
40 mm	610 mm	44,49			PG-18-60-F

Tijeras de podar de dos manos telescópica mango bi-componente 700-900 mm.



**PG-19**

Ø	L	€	Icon	Icon	Code
40 mm	700 - 900 mm	60,49			PG-19-F

Recambio de hoja para podaderas de dos manos



**R114V/R373A**

Icon	€	Icon	Icon
P160-SL	20,48	28	R160A-BULK28
P280-SL-80	25,19	25	R185V
P14	33,95	25	R114V
P14	23,53	28	R114V-BULK28
P-SL2, P116-SL	34,04	1	R16V
P-SL2, P116-SL	23,61	14	R16V-BULK14
P-SL, P114-SL	33,86	8	R115V
P-SL, P114-SL	27,53	14	R115V-BULK14
P16	30,62	1	R116V
P16	26,32	36	R116V-BULK36
P19-80	52,89	1	R119V
P160	26,06	1	R160A
P173-SL-85	33,74	25	R373A

Recambio de contra-hoja para podaderas de dos manos



**R214V/R260A/...**

Icon	€	Icon	Icon
P14	28,77	1	R214V
P14	15,48	28	R214V-BULK28
P116-SL	27,87	8	R216SL
P114-SL	26,57	1	R214SL
P160	25,68	16	R260A
P16*	28,63	40	R716VCB
P180-70	24,94	1	R680V
P19-80	32,67	1	R619V

Recambio de topes de goma para podaderas de dos manos y cortasetos



**R440V**

Icon	€	Icon	Icon
P-SL, P-SL2, P114, P116, P52-SL, P54-SL	7,88	22	R440V

Recambio de yunque con tornillos para podaderas de dos manos



**R372H**

Icon	€	Icon	Icon
P172-65 /-85, P172-SL	20,25	1	R372H

Perno central/tuerca para podaderas de dos manos



**R312V-R318V/R143PV/R144PV/R146**

Icon	€	Icon	Icon
P280-SL	10,94	12	R335V
P16	7,25	1	R143PV
P16*	7,90	1	R143PVCB
P160	7,31	24	R144PV
P14, P174, P176-75	7,33	24	R146VS
P14, P174, P176-75	4,75	50	R146VS-BULK50
P114-SL, P116-SL	9,80	22	R166V
P-SL-40 /-45 /-60	13,05	1	R315V
P280-(SL)	6,87	22	R328V
P180-70, P19-80, P172	13,99	1	R318V

Juego completo recambios mango, tornillo y tuerca para podaderas de dos manos



**R415V-R775V**

Icon	€	Icon	Icon
P280-SL	10,46	1	R775V
P173-SL-85	19,06	1	R776V
P-SL, P-SL2, P114, P116	10,22	1	R415V
P19-80	10,41	1	R519V
P14, P16	9,66	1	R615V
P160	9,04	24	R660V
P172-SL	6,71	14	R772V
P280-SL-80	6,30	1	R773V

Tornillo hexagonal para ajustar a la hoja al yunque



**R272H**

	€		
P173-SL-85	17,21	30	R472H
P172-65/-85, P172-SL-85	10,28	1	R272H

Pértiga telescópica corta de aluminio



**ATP-110-210**

	€		
1100 - 2100 mm	78,19	1	ATP-110-210



Adaptador para hojas de serruchos AS



**ASP-AS**

	€		
135 mm	18,76	6	ASP-AS

**SERRUCHOS CON PÉRTIGA Y PODADERAS DE ALTURA**

Pértiga telescópica de aluminio



**ATP-200**

	€		
2000-3520 mm	99,49	1	ATP-200-350
2070-5040 mm	115,89	1	ATP-200-500



Pértiga base de aluminio



**ASP-1850G**

	€		
1870 mm	52,75	1	ASP-1850G



Adaptador para podaderas de altura P34-37 y P34-27A-F



**ASP-ATP**

		€		
160 mm	100 g	28,54	6	ASP-ATP

Pértigas telescópicas



**AP-FP-**

	€		
2000 - 5000 mm	81,94	1	AP-5M
2000 - 3500 mm	62,04	1	AP-3M
1800 - 3200 mm	101,92	1	FP-3M



Extensión de aluminio para pértiga



**ASP-1850**

	€		
1870 mm	43,44	1	ASP-1850



Adaptador para serruchos ASP-AS en pértigas tradicionales AP-3M, AP-5M & FP-3M



**RAUNI**

		€		
ATP-110-210	82 g	18,49	6	RAUNI



Gancho para pértiga con adaptador válido para pértigas ASP y pértiga ATP-110-210



**ASP-AS-HOOK**



g € 40,95 4 ASP-AS-HOOK

Podadera de altura con pértiga telescópica y cabeza de corte giratoria



**ATP-230-410**



32 mm 2370 - 4110 mm 111,20 2 ATP-230-410

Hoja, tornillo y tuerca para podadera de pértiga ATP-230-410

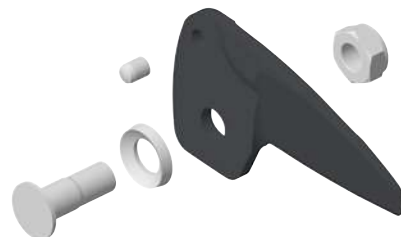

**R230P**

ATP-230-410 g € 24,70 10 R230P

Podadera de pértiga, triple efecto multiplicador



**P34-37**



40 mm € 70,23 2 P34-37

Podadera con pértiga



**AP-234**

30 mm 2200 mm 95,57 2 AP-234-F

Muelle para podadera de pértiga ATP-230-410



**R4230**

ATP-230-410 g € 7,36 10 R4230

Podadera de pértiga, Doble efecto multiplicador



**P34-27A**



30 mm € 37,46 2 P34-27A-F

Recambio de hoja de corte para podadera de pértiga



**R137E**

P34-37 € 21,34 30 R137E

Tope de goma



**RBCP**

ATP-110-210 g € 11,28 10 RBCP

Tope de goma y mango interior para podadera de pértiga



**RBCP230**

		€		
ATP-230-410	66 g	10,90	12	RBCP230

Recambio de perno central y tuerca



**R142P/R337E**

	€		
P34-37	10,69	1	R337E

Multiplicador para ATP-230-411



**RPL230G**

		€		
ATP-230-410	72 g	25,98	8	RPL230G

Leva y tornillo para ATP-200-350/500



**RCAM**

		€		
ATP-200-350 ; ATP-200-500 ; ATP-110-210	29 g	4,47	20	RCAM30
ATP-200-500 ; ATP-110-210	37 g	4,47	20	RCAM36

Cuerda de 7 metros para ATP-230-411



**RD7M**

		€		
ATP-230-410	19 g	25,32	20	RD7M

Recambio de muelle para podadera de pértiga



**R427AE/R427E/R437E**

	€		
P134, P34-27A	9,61	18	R427AE
P34-37	10,69	18	R437E

Cuerda de 1 metro para ATP-230-410



**RD1M**

		€		
ATP-230-410	5 g	13,57	15	RD1M

Recambio de contra-hoja para podaderas de una mano y de pértiga



**R133PG**

	€		
P34-27A	13,21	1	R133PG

Serrucho curvo con dentado japonés, para pértigas ASP. Corte fino



**ASP-AS-C F**

		€		
330 mm	7	63,94	5	ASP-AS-C33-JT-F





Serrucho curvo con dentado japonés, para pértigas ASP. Corte medio



**ASP-AS-C M**

Icon	Icon	€	Icon	Icon
360 mm	6.2	<b>66,68</b>	5	ASP-AS-C36-JT-M

Serrucho de poda



**383-/384-**

Icon	Icon	€	Icon	Icon
360 mm	6	<b>20,58</b>	4	383-6T
360 mm	6	<b>19,37</b>	4	384-6T
360 mm	5	<b>19,37</b>	4	384-5T

Cortasetos



**P51-SL**

Icon	Icon	€	Icon	Icon
570 mm	25 cm	<b>53,26</b>	2	P51-SL

Serrucho curvo con dentado japonés, para pértigas ASP. Corte grueso



**ASP-AS-C C**

Icon	Icon	€	Icon	Icon
390 mm	5.4	<b>73,22</b>	5	ASP-AS-C39-JT-C
450 mm	5.4	<b>75,84</b>	2	ASP-AS-C45-JT-C

Serrucho de poda, para pértiga telescópica de Ø 25 mm



**385-/386-**

Icon	Icon	€	Icon	Icon
360 mm	6	<b>20,58</b>	4	385-6T
360 mm	6	<b>21,78</b>	4	386-6T

Cortasetos mangos largos



**P51H-SL**

Icon	Icon	€	Icon	Icon
730 mm	25 cm	<b>56,19</b>	2	P51H-SL

**CORTASETOS**

Serrucho de poda



**339-/340-**

Icon	Icon	€	Icon	Icon
360 mm	6	<b>18,16</b>	4	339-6T
360 mm	6	<b>19,37</b>	4	340-6T

Cortasetos profesional, mangos largos



**P51**

Icon	Icon	€	Icon	Icon
570 mm	25 cm	<b>53,26</b>	2	P51-F

Cortasetos con mango de madera



**P57-25**

Icon	Icon	€	Icon	Icon
540 mm	23 cm	<b>40,96</b>	4	P57-25-F

Cortasetos ligero, corto



**P54-SL**

		€		
550 mm	22.5 cm	110,02	2	P54-SL-25



Cortasetos ligero



**PG-56**

		€		
540 mm	23 cm	42,14	2	PG-56-F



Recambios de topes de goma para corta setos



**R444V-R516V**

	€		
P14, P16, P180-70, P19-80, P160-60, P51	5,45	22	R515VS
P160, P160-SL, P280-SL	4,58	22	R516V
P53-SL, P54H-SL, P52-SL-20	6,12	22	R444V

Cortasetos ligero, mango largo



**P54H-SL**

		€		
650 mm	22.5 cm	110,01	2	P54H-SL-25



Cortasetos telescópico



**PG-57-F**

		€		
800-1050 mm	20 cm	44,49	2	PG-57-F



Perno central/tuerca para cortasetos



**R146VC/R147V**

	€		
P51, P51H, P52, P53, P54, P52-SL-20, P74, P75	8,47	22	R146VC
P55, P57	7,32	24	R147V

Cortasetos ligero de precisión para arte topiario



ergo®



**P52-SL-20**

		€		
590 mm	18 cm	91,26	2	P52-SL-20



Cortasetos



**P59**

		€		
580 mm	21 cm	34,17	6	P59-25-F



**TIJERAS CORTACÉSPEDS**

Tijera cortacésped regulable en tres posiciones



**GS-76**

		€		
355 mm	435 g	21,61	8	GS-76



Tijera cortacésped regulable de 9 posiciones (180°)



**GS-180**

		€		
375 mm	317 g	29,48	6	GS-180-F

Tijera cortacésped



**P74**

		€		
1100 mm	2000 g	63,48	40	P74

Tijera cortacésped



**P75**

		€		
1000 mm	1900 g	62,35	1	P75

## TIJERAS FLORALES

Tijera tamaño pequeño



**FS-5**

€		
16,80	10	FS-5

Tijera tamaño medio



**FS-8**

€		
22,87	10	FS-8

Tijera tamaño grande



**FS-7.5**

€		
28,21	10	FS-7.5

## ARCOS TRONZADORES

Arco tronizador para madera verde y seca



**ergo**



**10**

		€		
530 mm	21 in	15,95	5	10-21-51
607 mm	24 in	17,14	5	10-24-23
607 mm	24 in	17,13	5	10-24-51
759 mm	30 in	19,37	5	10-30-23
759 mm	30 in	20,85	5	10-30-51

Arco tronizador



**ergo**



**332**

		€		
530 mm	21 in	18,89	5	332-21-51

Arco tronizador profesional



**SE -15-16**

		€		
530 mm	21 in	8,79	5	SE-16-21
530 mm	21 in	7,59	5	SE-16-21-23
607 mm	24 in	8,63	5	SE-15-24
759 mm	30 in	9,17	5	SE-15-30
759 mm	30 in	9,25	5	SE-15-30-23
810 mm	32 in	10,11	5	SE-15-32
912 mm	36 in	10,76	5	SE-15-36
912 mm	36 in	10,71	5	SE-15-36-23

Arco tronizador



**331-21**

		€		
530 mm	21 in	15,95	5	331-21-51-KP

Arco tronizador con hoja posicionable



**2-21-51**

		€		
530 mm	21 in	16,84	5	2-21-51

Arco de sierra multiuso - madera y metal



**9-12**

		€		
320 mm	12 in	19,08	5	9-12-51/3806-KP

Arco tronizador manejable de 15" madera verde



**331-15**

		€		
378 mm	15 in	14,91	5	331-15-23

Arco tronizador con hoja posicionable



**333**

		€		
350 mm	14 in	30,33	5	333

Hoja de arco tronizador - madera seca



**51**

		€		
320 mm	12-1/2 in	3,69	10	51-12
530 mm	20.75 in	4,97	10	51-21
607 mm	24 in	5,31	10	51-24
759 mm	30 in	5,95	10	51-30
810 mm	28.57 in	6,18	10	51-32
912 mm	36 in	6,42	10	51-36

Arco tronizador con hoja posicionable



**3-24-51**

		€		
607 mm	24 in	19,00	5	3-24-51

Arco tronizador para tubos de ventilación



**14-24**

		€		
607 mm	24 in	21,92	5	14-24-3810

Hoja de arco tronizador - madera verde



**23**

		€		
378 mm	13.33 in	2,81	10	23-15
530 mm	20.75 in	4,97	10	23-21
607 mm	24 in	5,31	10	23-24
759 mm	30 in	5,95	10	23-30
810 mm	28.57 in	6,18	10	23-32
912 mm	36 in	6,57	10	23-36



Hoja para arco tronizador: madera verde para arco 333



**333-5**

		€		
350 mm	13-3/4 in	7,51	10	333-5

## SERRUCHOS DE PODA

Serrucho de poda



**349**

		€		
300 mm	7	12,00	4	349

Serrucho de poda plegable



**PG-72**

		€		
190 mm	7	18,33	4	PG-72

Serrucho plegable, dentado XT, recubrimiento especial



**396-LAP**

		€		
190 mm	200 g	39,59	10	396-LAP
190 mm	44 g	16,36	100	396-BLADE
190 mm	44 g	14,96	1	396-BLADE-1P

-IP: Embalaje industrial

Serrucho de poda plegable, dentado JS



**396-JS**

		€		
190 mm	5	24,21	4	396-JS

Serrucho de poda plegable, dentado JT



**396-JT**

		€		
190 mm	7	24,21	4	396-JT

Serrucho de poda plegable, dentado XT



**396-HP**

		€		
190 mm	7	20,58	4	396-HP

Serrucho de poda con mango de madera



**4211-/4212-**

		€		
280 mm	6	18,16	4	4211-11-6T
360 mm	6	20,58	4	4211-14-6T
280 mm	6	18,16	4	4212-11-6T
360 mm	6	20,58	4	4212-14-6T

Serrucho de poda con funda, sin velcro



**51-JS**

		€		
240 mm	5	23,50	4	5124-JS-H
280 mm	5	28,21	4	5128-JS-H

Serrucho de poda, dentado JT



**41-JT**

		€		
240 mm	7	24,21	4	4124-JT-H
280 mm	7	29,06	4	4128-JT-H



Juego de serrucho plegable 396-LAP y  
cuchillo - machete 2444-LAP



### LAP-KNIFE



	€		
329 g	42,75	10	LAP-KNIFE

396-LAP	
2444-LAP	

Hojas de recambio para serrucho de poda  
51-JS



### 5724-JS/5728-JS

		€		
240 mm	5	16,45	1	5724-JS
280 mm	5	19,75	1	5728-JS

Hojas de recambio para serrucho de poda  
41-JT



### 4724-JT/4728-JT

		€		
240 mm	7	18,16	1	4724-JT
280 mm	7	18,76	1	4728-JT

Hojas de recambio para serrucho 396-JS



### 396-JS-BLADE

		€		
190 mm	5	21,78	200	396-JS-BLADE

Hojas de recambio para serrucho 396-JT



### 396-JT-BLADE

		€		
190 mm	7	21,78	200	396-JT-BLADE

Hoja de recambio para serrucho 396-HP



### 396-HP-BLADE

		€		
190 mm	7	13,31	200	396-HP-BLADE

Hojas de recambio, serrucho/poda 4211,  
4212, 339 y 340



### 4400-/4420-

		€		
280 mm	6	11,79	10	4400-11
360 mm	6	13,31	10	4400-14
280 mm	6	11,79	10	4420-11

		€		
360 mm	6	13,31	10	4420-14
280 mm	6	10,29	10	4400-11-BULK
360 mm	6	11,49	10	4400-14-BULK
280 mm	6	10,29	10	4420-11-BULK
360 mm	6	11,49	10	4420-14-BULK

## REPUESTOS Y ACCESORIOS

Hoja curva de repuesto serrucho para  
pértiga, corte fino



### AS-F-BLADE

		€		
330 mm	7	33,90	15	AS-C33-JT-F

Hoja curva de repuesto serrucho para  
pértiga, corte medio



### AS-M-BLADE

		€		
360 mm	6.2	36,32	15	AS-C36-JT-M

Hoja curva de repuesto serrucho para  
pértiga, corte grueso



### AS-C-C-BLADE

		€		
390 mm	5.4	36,32	15	AS-C39-JT-C
450 mm	5.4	42,36	15	AS-C45-JT-C



## ACCESORIOS Y MANTENIMIENTO

Piedra sintética para afilado, 2 granos 180/400



### LS-COMBINESS

	€		
100 mm	13,33	600	LS-COMBINESS

Piedra sintética para afilado, grano 180



### LS-PIERRE-FAUX

	€		
230 mm	16,88	90	LS-PIERRE-FAUX

Funda de cuero



### PROF-H

	€		
86 g	25,58	1	PROF-H

Piedra sintética para afilado, grano 320



### LS-CORINDON

	€		
100 mm	15,89	1	LS-PIERRE CORINDON

Piedra sintética, tipo "Carbor", para afilado, grano 220



### LS-6160-23

	€		
230 mm	9,21	90	LS-6160-23

Funda para podadera de dos manos



### PROF-LOPP

	€		
390 g	34,59	1	PROF-LOPP

Afilador profesional de carburo



### SHARP-X

	€		
100 mm	23,95	10	SHARP-X
100 mm	718,21	1	SHARP-X-DISP

Lubricante 50 ml



### LUB-2015

	€		
60 g	20,56	6	LUB-2015

Funda para podadera



### PROF-SEC

	€		
150 g	21,65	1	PROF-SEC

## NAVAJAS DE PODA

Navaja para injertar



**P11**

		€		
180 mm	70 g	40,53	6	P11

Navaja para injertar



**P20**

		€		
190 mm	100 g	48,10	6	P20

Navaja multi-uso



**K-AP-1**

	€		
90 g	32,38	10	K-AP-1

Navaja multi-uso



**K-GP-1**

	€		
90 g	35,40	10	K-GP-1



# Herramientas neumáticas de exterior



## TIJERAS DE PODA NEUMÁTICAS

Podadera neumática



**9210**

		€		
30 mm	257,42	1	9210	

Hoja para podadera neumática



**9210-1**

		€		
9210	82 g	55,86	1	9210-1

Cabeza cortante para podadera neumática



**9210-10**

		€		
9210	212 g	104,84	1	9210-10

Anillos para las juntas Tijera Neumática 9210



**9210-20**

		€		
9210	28 g	14,41	1	9210-20

Casquillos de latón



**9210-1720100**

		€		
9210	55.3 g	11,47	1	9210-1720100

Sello para pistón



**9210-1230235**

		€		
9210	6.7 g	8,09	1	9210-1230235

Pistón



**9210-1690148**

		€		
9210	22 g	19,86	1	9210-1690148

Amortiguadores



**9210-1730107**

		€		
9210	176 g	13,81	10	9210-1730107

Muelles de retorno



**9210-1640142**

		€		
9210	26.6 g	8,70	1	9210-1640142

Varilla de acoplamiento



**9210-1700118**

		€		
9210	41 g	42,07	1	9210-1700118

Tornillos autorroscantes o de chapa



**9210-1060238**

		€		
9210	10 g	0,48	20	9210-1060238

Tornillo TCCE



**9210-1060177**

		€		
9210	7 g	0,93	1	9210-1060177

Remache



**9210-1770106**

		€		
9210	1000 g	5,79	10	9210-1770106

Cubierta frontal



**9210-1830137**

		€		
9210	9.5 g	9,22	1	9210-1830137

Protector de mano



**9210-1320281**

		€		
9210	35 g	9,30	10	9210-1320281

Junta de protección del polvo



**9210-1230219**

		€		
9210	8.6 g	6,98	20	9210-1230219

Cuerpo de podadera



**9210-1710266**

		€		
9210	193 g	68,75	1	9210-1710266







**BAHCO®**



**Lindström**

► KITS Y SETS

KITS DE JOYERÍA

Kit de joyería con alicates y cortantes ergonómicos bimateriales



9061

€ 164,80 1 9061

RX 8141		
RX 7893		
RX 7490		
RX 7590		

Kit de joyería con alicates y cortantes monomateriales



9060

€ 154,50 1 9060

8141		
7893		
7490		
7590		

► ALICATE DE PRECISIÓN

CABEZA AFILADA

Alicate de precisión Micro con cabeza cónica



6151

€ Micro Edge 0.2-1.6/0.01-0.06 23,68 10 6151

Alicate de precisión a ras con cabeza cónica



6152

€ Flush Edge 0.2-1.6/0.01-0.06 24,62 10 6152

Alicate de precisión a ras de acero inoxidable con cabeza cónica



6152SS

€ Flush Edge 0.2-1.6/0.01-0.06 33,89 10 6152SS

CABEZA PUNTIAGUDA

Alicate de precisión a ras con cabeza puntiaguda



6159

€ Flush Edge 0.2-1.0/0.01-0.039 28,74 10 6159

CABEZA OBLICUA

Alicate de precisión a ras con cabeza oblicua



6258

€ Flush Edge 0.2-1.0/0.01-0.039 28,74 10 6258

SETS ALICATES DE PRECISIÓN

Juego de 3 alicates con resultado de corte cónico micro y al ras y versión puntiaguda



EDGE-LAUNCH1

€ 139,05 1 EDGE-LAUNCH1

6151		
6152		
6159		

## ▶ DESTORNILLADORES DE PRECISIÓN

### ESD

Destornilladores planos ESD de precisión 1.5-3.0 mm



### 800ESD

Width	Length	Price	Qty	Part No.
1.5 mm	50 mm	4,01	10	800-1.5-50ESD
2.0 mm	50 mm	6,10	10	800-2-50ESD
2.5 mm	50 mm	3,48	10	800-2.5-50ESD
3.0 mm	50 mm	3,31	10	800-3-50ESD

Destornilladores Phillips ESD de precisión PH00-PH1



### 801ESD

Type	Length	Price	Qty	Part No.
PH00	50 mm	4,93	10	801-00-50ESD
PH0	50 mm	4,23	10	801-0-50ESD
PH1	75 mm	4,63	10	801-1-75ESD

Destornilladores TORX® ESD de precisión T6-T20



### 803ESD

Type	Length	Price	Qty	Part No.
T6	50 mm	5,79	10	803-6-50ESD
T7	50 mm	6,04	10	803-7-50ESD
T8	50 mm	6,11	10	803-8-50ESD
T9	50 mm	7,81	10	803-9-50ESD
T10	50 mm	7,81	10	803-10-50ESD
T15	75 mm	7,90	10	803-15-75ESD
T20	75 mm	7,96	10	803-20-75ESD

Destornilladores Pentalobe ESD de precisión TS1-TS5



### 805ESD

Type	Length	Price	Qty	Part No.
TS1	50 mm	8,60	10	805-TS1-50ESD
TS4	50 mm	6,52	10	805-TS4-50ESD
TS5	50 mm	9,17	10	805-TS5-50ESD

Juego de destornilladores planos/Phillips ESD de precisión 1.5-3.0mm/PH00-PH1 - 7 piezas



### 801-7ESD

Qty	Price	Qty	Part No.
7	41,06	1	801-7ESD

800-1.5-50ESD, 800-2-50ESD, 800-2.5-50ESD, 800-3-50ESD

801-00-50ESD, 801-0-50ESD, 801-1-75ESD

Juego de destornilladores TORX® ESD de precisión T6-T20 - 7 piezas



### 803-7ESD

Qty	Price	Qty	Part No.
7	42,33	1	803-7ESD

803-6-50ESD, 803-7-50ESD, 803-8-50ESD, 803-9-50ESD, 803-10-50ESD, 803-15-75ESD, 803-20-75ESD

## ▶ CORTANTES "HEAVY DUTY"

### ALICATES CORTE DIAGONAL

Alicates de corte diagonal para industria pesada con mango bi-componente



ergo®



### TRX 8180

Width	Length	Price	Qty	Part No.
4.5 mm	2.5 mm	61,80	5	TRX 8180





## CORTANTES DE PRECISIÓN

### ALICATES CORTE DIAGONAL

Alicates de corte diagonal de precisión ERGO™ con cabeza ovalada



ergo



#### RX 8130-RX 8162



Diagram	Diagram	€	Quantity	Model
0.00-0.04 / 0.2-1.0	Micro-Bevel®	56,65	10	RX 8130
0.00-0.04 / 0.1-1.0	Flush	59,23	10	RX 8131
0.00-0.03 / 0.1-0.8	Ultra-Flush®	61,80	10	RX 8132
0.00-0.05 / 0.2-1.25	Micro-Bevel®	56,65	10	RX 8140
0.00-0.05 / 0.1-1.25	Flush	59,23	10	RX 8141
0.00-0.04 / 0.1-1.0	Ultra-Flush®	61,80	10	RX 8142
0.01-0.06 / 0.3-1.6	Micro-Bevel®	59,23	10	RX 8150
0.00-0.06 / 0.2-1.6	Flush	61,80	10	RX 8151
0.00-0.05 / 0.2-1.25	Ultra-Flush®	64,38	10	RX 8152
0.02-0.08 / 0.4-2.0	Micro-Bevel®	64,38	10	RX 8160
0.01-0.08 / 0.3-2.0	Flush	66,95	10	RX 8161
0.01-0.06 / 0.3-1.6	Ultra-Flush®	69,53	10	RX 8162

Alicates de corte diagonal de precisión con cabeza ovalada y mango de seguridad ESD



#### 8130-8162



Diagram	Diagram	€	Quantity	Model
0.01-0.04 / 0.2-1.0	Micro-Bevel®	51,50	10	8130
0.00-0.04 / 0.1-1.0	Flush	54,08	10	8131
0.00-0.03 / 0.1-0.8	Ultra-Flush®	56,65	10	8132
0.01-0.05 / 0.2-1.25	Micro-Bevel®	51,50	10	8140
0.00-0.05 / 0.1-1.25	Flush	54,08	10	8141
0.00-0.04 / 0.1-1.0	Ultra-Flush®	56,65	10	8142
0.01-0.06 / 0.3-1.6	Micro-Bevel®	51,50	10	8150
0.01-0.06 / 0.2-1.6	Flush	54,08	10	8151
0.00-0.05 / 0.1-1.25	Ultra-Flush®	56,65	10	8152
0.02-0.08 / 0.4-2.0	Micro-Bevel®	54,08	10	8160
0.01-0.08 / 0.3-2.0	Flush	56,65	10	8161

Diagram	Diagram	€	Quantity	Model
0.01-0.08 / 0.3-1.6	Ultra-Flush®	59,23	10	8162
0.00-0.04 / 0.1-1.0	Flush	54,08	10	8131 CO
0.01-0.05 / 0.2-1.25	Micro-Bevel®	51,50	10	8140 CO
0.00-0.05 / 0.1-1.25	Flush	54,08	10	8141 CO
0.00-0.04 / 0.1-1.0	Ultra-Flush®	56,65	10	8142 CO
0.01-0.06 / 0.3-1.6	Micro-Bevel®	51,50	10	8150 CO
0.01-0.06 / 0.2-1.6	Flush	54,08	10	8151 CO
0.02-0.08 / 0.4-2.0	Micro-Bevel®	54,08	10	8160 CO
0.01-0.08 / 0.3-2.0	Flush	56,65	10	8161 CO

Cortantes diagonales de precisión ERGO™ con cabeza cónica



ergo



#### RX 8133-RX 8165



Diagram	Diagram	€	Quantity	Model
0.008-0.04 / 0.2-1.0	Micro-Bevel®	59,23	10	RX8133
0.004-0.03 / 0.1-0.8	Flush	61,80	10	RX8134
0.01-0.05 / 0.2-1.25	Micro-Bevel®	59,23	10	RX 8143
0.00-0.05 / 0.1-1.25	Flush	61,80	10	RX 8144
0.00-0.04 / 0.1-1.0	Ultra-Flush®	64,38	10	RX 8145
0.01-0.06 / 0.3-1.6	Micro-Bevel®	61,80	10	RX 8153
0.01-0.06 / 0.2-1.6	Flush	64,38	10	RX 8154
0.01-0.05 / 0.2-1.25	Ultra-Flush®	66,95	10	RX8155
0.02-0.08 / 0.4-2.0	Micro-Bevel®	66,95	10	RX8163
0.01-0.08 / 0.3-2.0	Flush	69,53	10	RX 8164
0.01-0.06 / 0.3-1.6	Ultra-Flush®	72,10	10	RX 8165

Cortantes diagonales de precisión con cabeza cónica



#### 8133-8165



Diagram	Diagram	€	Quantity	Model
0.008-0.04 / 0.2-1.0	Micro-Bevel®	54,08	10	8133
0.004-0.03 / 0.1-0.8	Flush	56,65	10	8134
0.004-0.02 / 0.1-0.5	Ultra-Flush®	59,23	10	8135
0.01-0.05 / 0.2-1.25	Micro-Bevel®	54,08	10	8143
0.01-0.05 / 0.2-1.25	Flush	56,65	10	8144
0.00-0.04 / 0.1-1.0	Ultra-Flush®	59,23	10	8145
0.01-0.06 / 0.3-1.6	Micro-Bevel®	54,08	10	8153
0.01-0.06 / 0.2-1.6	Flush	56,65	10	8154

Diagram	Diagram	€	Quantity	Model
0.01-0.05 / 0.2-1.25	Ultra-Flush®	59,23	10	8155
0.02-0.08 / 0.4-2.0	Micro-Bevel®	56,65	10	8163
0.01-0.08 / 0.3-2.0	Flush	59,23	10	8164
0.01-0.06 / 0.3-1.6	Ultra-Flush®	61,80	10	8165
0.01-0.05 / 0.2-1.25	Flush	56,65	10	8144 CO
0.01-0.06 / 0.2-1.6	Flush	56,65	10	8154 CO
0.02-0.08 / 0.4-2.0	Micro-Bevel®	56,65	10	8163 CO
0.01-0.06 / 0.3-1.6	Ultra-Flush®	61,80	10	8165 CO

Alicates de corte diagonal con cabeza cónica y mango de seguridad ESD



#### 7190-7191



Diagram	Diagram	€	Quantity	Model
0.00-0.04 / 0.2-1.0	Micro-Bevel®	54,08	10	7190
0.00-0.04 / 0.1-1.0	Flush	56,65	10	7191
0.00-0.04 / 0.2-1.0	Micro-Bevel®	54,08	10	7190 CO
0.00-0.04 / 0.1-1.0	Flush	56,65	10	7191 CO

Cortantes diagonales de precisión ERGO™ con cabeza cónica y rebaje



ergo



#### RX 8136-RX 8168



Diagram	Diagram	€	Quantity	Model
0.004-0.03 / 0.1-0.8	Micro-Bevel®	61,80	10	RX8136
0.004-0.03 / 0.1-0.8	Flush	64,38	10	RX 8137
0.004-0.02 / 0.1-0.5	Ultra-Flush®	66,95	10	RX8138
0.01-0.04 / 0.2-1.0	Micro-Bevel®	64,38	10	RX 8146
0.00-0.04 / 0.1-1.0	Flush	66,95	10	RX 8147
0.00-0.03 / 0.1-0.8	Ultra-Flush®	69,53	10	RX 8148
0.01-0.05 / 0.3-1.25	Micro-Bevel®	64,38	10	RX 8156
0.01-0.05 / 0.2-1.25	Flush	66,95	10	RX 8157
0.01-0.04 / 0.2-1.0	Ultra-Flush®	69,53	10	RX 8158
0.02-0.06 / 0.4-1.5	Micro-Bevel®	69,53	10	RX8166
0.01-0.06 / 0.3-1.5	Flush	72,10	10	RX 8167
0.01-0.05 / 0.3-1.25	Ultra-Flush®	74,67	10	RX 8168



Cortantes diagonales de precisión con cabeza cónica y rebaje y mango de seguridad de ESD



### 8136-8168



	€		
0.004-0.03 / 0.1-0.8 Micro-Bevel®	56,65	10	8136
0.004-0.03 / 0.1-0.8 Flush	59,23	10	8137
0.004-0.02 / 0.1-0.5 Ultra-Flush®	61,80	10	8138
0.01-0.04 / 0.2-1.0 Micro-Bevel®	56,65	10	8146
0.01-0.04 / 0.1-1.0 Flush	59,23	10	8147
0.00-0.03 / 0.1-0.8 Ultra-Flush®	61,80	10	8148
0.01-0.05 / 0.3-1.25 Micro-Bevel®	56,65	10	8156
0.01-0.05 / 0.2-1.25 Flush	59,23	10	8157
0.01-0.04 / 0.2-1.0 Ultra-Flush®	61,80	10	8158
0.02-0.06 / 0.4-1.5 Micro-Bevel®	61,80	10	8166L
0.01-0.06 / 0.3-1.5 Flush	64,38	10	8167L
0.01-0.05 / 0.3-1.25 Ultra-Flush®	66,95	10	8168L
0.00-0.03 / 0.1-0.8 Ultra-Flush®	61,80	10	8148 CO

### ALICATES CORTE DIAGONAL, CABEZA ESPECIAL

Alicates de corte diagonal de precisión ERGO™ con cabeza cónica y con punta rebajada



### RX8137MX-RX8138MX



	€		
0.1-0.8 mm Flush	77,25	10	RX8137MX
0.1-0.8 mm Ultra-Flush®	77,25	10	RX8138MX

### ALICATES DE CORTE OBLICUO

Alicates de precisión de corte frontal oblicuo en ángulo 0,35 mm-1,25 mm



### 7290-7291



	€		
0.01-0.03 / 0.35-0.8 Micro-Bevel®	56,65	10	7290
0.01-0.03 / 0.35-0.8 Flush	59,23	10	7291

Alicates de corte frontal con cabeza muy pequeña



### 7292



	€		
0.01-0.03 / 0.35 Flush	51,50	10	7292

Alicates de corte oblicuo y angulados, 0,35-1 mm



### 7293



	€		
0.01-0.03 / 0.35-0.8 Flush	61,80	10	7293

### ÁNGULO

Alicates de corte oblicuo de 20° cortos ERGO™, 0,2-1,2 mm



### RX 8211



	€		
0.01-0.05 / 0.2-1.2 Flush	48,93	10	RX 8211

Alicates de corte oblicuo de 20° cortos, 0,2-1,2 mm



### 8211



	€		
0.01-0.05 / 0.2-1.2 Flush	77,25	10	8211

Alicates de corte oblicuo de 45° largos ERGO™, 0,2-1 mm



### RX 8247



	€		
0.01-0.04 / 0.2-1.0 Flush	56,65	10	RX 8247

Alicates de corte oblicuo de cabeza larga de 45° de 0,2 mm-1 mm



**8247**



Modelo	Característica	€	Cant.	Ref.
0.01-0.04 / 0.2-1.0	Flush	77,25	10	8247
0.01-0.04 / 0.2-1.0	Flush	77,25	10	8247 CO

Alicates de corte oblicuo de cabeza larga y en relieve de 45° de 0,2 mm-0,8 mm



**8248**



Modelo	Característica	€	Cant.	Ref.
0.01-0.03 / 0.2-0.8	Flush	82,40	10	8248
0.00-0.03 / 0.2-0.8	Flush	82,40	10	8249
0.01-0.03 / 0.2-0.8	Flush	82,40	10	8248 CO

Alicates de corte oblicuo de 45°, de cabeza larga y en relieve ERGO™, 0,2 mm-0,8 mm



ergo



**RX 8248**



Modelo	Característica	€	Cant.	Ref.
0.01-0.03 / 0.2-0.8	Flush	59,23	10	RX 8248

Alicates de corte oblicuo y ángulo inverso, 0,2-0,8 mm



**7280**



Modelo	Característica	€	Cant.	Ref.
0.01-0.03 / 0.2-0.8	Flush	56,65	10	7280

Alicates de corte oblicuo de 45°, 0,2-1 mm



**7285**



Modelo	Característica	€	Cant.	Ref.
0.2-1.0 mm	Flush	56,65	10	7285

## CORTADOR PARA PLÁSTICO

Alicates de plástico de corte diagonal ERGO™



ergo



**P6160**

Modelo	Característica	€	Cant.	Ref.
1.5 mm	Flush	82,40	10	P6160

## CORTE CON PUNTA

Alicates de corte diagonal con punta de precisión ERGO™



ergo



**RX 8149**



Modelo	Característica	€	Cant.	Ref.
0.01-0.02 / 0.1-0.6	Flush	79,83	10	RX 8149

Alicates de corte diagonal con punta de precisión y mango protegido contra ESD



**8149**



Modelo	Característica	€	Cant.	Ref.
0.00-0.02 / 0.1-0.6	Flush	77,25	10	8149

## ALICATES DE CORTE OBLICUO, CABEZA ESPECIAL

Alicates de corte con cabeza larga con cabeza cónica y rebajada de 45° con cabeza especial de 0,2mm-0,8mm



**8248Q**



Modelo	Característica	€	Cant.	Ref.
0.00-0.03 / 0.2-0.8	Ultra-Flush®	87,55	10	8248Q

Alicates de corte frontal oblicuo de precisión con cabeza especial muy pequeña



**7292G**



		€		
0.01-0.03 / 0.35	Flush	<b>66,95</b>	10	7292G

### CORTANTES PUNTA MICRO

Alicates de precisión con micropunta ERGO™, 149 mm



ergo



**RX 8233**



		€		
0.004-0.024 / 0.1-0.6	Flush	<b>159,65</b>	10	RX8233A

Cortantes de precisión con micro puntas ERGO™, 141 mm



ergo



**RX 8234**



		€		
0.002-0.018 / 0.05-0.4	Flush	<b>159,65</b>	10	RX8234A

Alicates de precisión con micropunta ERGO™, 144 mm



ergo



**RX 8237**



		€		
0.004-0.02 / 0.1-0.5	Flush	<b>159,65</b>	10	RX8237A

### CIZALLAS MULTIUSOS

Alicates de corte multiusos con mangos antideslizantes



**HS6000**



		€		
Kevlar	Flush	<b>66,95</b>	10	HS6000
Kevlar	Flush	<b>66,95</b>	10	HS6001

### ACCESORIOS Y REPUESTOS

Recogevirutas para alicates de corte diagonal de las series 8130 y 8140



**813/814/816**

	€		
8130-8132, Rx 8130-8132	<b>6,18</b>	1	813
8140-8148, Rx 8140-8148	<b>4,63</b>	1	814
8130-8132, 8140-8148	<b>6,18</b>	1	816

Muelles de retorno para la serie RX



**RX 01**

	g	€		
5 g		<b>11,33</b>	1	RX 01

Muelles de retorno para las series 80, Supreme y HS



**8130-50/8160**

	g	€		
1 g		<b>160,48</b>	1	8130-50/SUPR SPRING
1 g		<b>94,28</b>	1	8160/SPRING

## CORTANTES DE PRECIÓN PARA MATERIALES DUROS

### CORTANTE DE CARBURO

Alicates de corte diagonal de carburo de precisión con cabeza cónica para materiales duros



**7154 TC**



0.1-0.9 mm 0.1-0.4 mm **200,85** 10 7154TC

### ALICATES CORTE DIAGONAL EXTRA REFORZADO

Cortantes diagonales de precisión ERGO™ con cabeza ovalada y endurecido extra



ergo



**RX 8140M2-8160M2**



0.01-0.05 / 0.4-2.0 Micro-Bevel® **77,25** 10 RX8140M2  
0.01-0.06 / 0.4-2.0 Micro-Bevel® **87,55** 10 RX8150M2  
0.02-0.08 / 0.4-2.0 Micro-Bevel® **87,55** 10 RX8160M2

Cortantes diagonales de precisión con cabeza ovalada y mango de seguridad ESD con endurecido extra



**8140M2-8160M2**



0.01-0.05 / 0.4-2.0 Micro-Bevel® **61,80** 10 8140M2  
0.01-0.06 / 0.4-2.0 Micro-Bevel® **72,10** 10 8150M2  
0.02-0.08 / 0.4-2.0 Micro-Bevel® **82,40** 10 8160 M2

### ALICATES CORTE DIAGONAL RENDIMIENTO ESPECIFICO

Alicates corte diagonal de precisión ERGO™ con cabeza ovalada



ergo



**RX 8140PS-RX 8161PS**



0.01-0.04 / 0.1-1.0 Micro-Bevel® **77,25** 10 RX8140PS  
0.01-0.04 / 0.1-1.0 Flush **79,83** 10 RX8141PS  
0.01-0.04 / 0.1-1.0 Micro-Bevel® **82,40** 10 RX 8142PS  
0.01-0.04 / 0.1-1.0 Micro-Bevel® **82,40** 10 RX8150PS  
0.01-0.06 / 0.3-1.6 Flush **84,98** 10 RX 8161PS

Cortantes diagonales con rendimiento específico de precisión con cabeza ovalada y mangos de seguridad ESD para materiales duros



**8140PS-8161PS**



0.01-0.04 / 0.1-1.0 Micro-Bevel® **77,25** 10 8140PS  
0.01-0.04 / 0.1-1.0 Flush **77,25** 10 8141PS  
0.00-0.05 / 0.1-1.25 Micro-Bevel® **82,40** 10 8150PS  
0.01-0.06 / 0.3-1.6 Micro-Bevel® **82,40** 10 8160PS  
0.01-0.06 / 0.3-1.6 Flush **84,98** 10 8161PS

Cortantes diagonales de precisión ERGO™ con cabeza cónica y mangos de seguridad ESD para materiales duros



ergo



**RX8143PS-RX 8147PS**



0.01-0.04 / 0.1-1.0 Flush **84,98** 10 RX8143PS  
0.004-0.03 / 0.1-0.8 Flush **87,55** 10 RX 8147PS

### ALICATES CORTE DIAGONAL RENDIMIENTO ESPECIFICO, CABEZA ESPECIAL

Alicates de corte diagonal de precisión ERGO™ con cabeza ovalada y punta rebajada



ergo



**RX8140PSF-RX8160BPS**



0.01-0.04 / 0.1-1.0 Micro-Bevel® **87,55** 10 RX8160BPS

Cortantes diagonales de precisión de rendimiento específico con cabeza ovalada



**8154PSP**



0.00-0.05 in Micro-Bevel® **87,55** 10 8154PSP

## ALICATES DE MANIPULACIÓN DE PRECISIÓN

### BOCA PLANA

Alicates de boca plana con mango sintético bi-componente



**7490**

AI		€		
20 mm	S	51,50	10	7490
20 mm	S	51,50	10	7490 CO

Alicates de boca plana de precisión ERGO™ con mango sintético bi-componente



ergo



**RX 7490**

AI		€		
20 mm	S	54,08	10	RX 7490

### BOCA REDONDA

Alicates de boca redonda y de precisión ERGO™ con mango bi-componente sintético



ergo



**RX 7590**

AI		€		
20 mm	S	46,35	10	RX 7590

Alicates de boca redonda con mango sintético



**7590-7591**

AI		€		
20 mm	S	51,50	10	7590
20 mm	S	51,50	10	7590 CO
38.5 mm	M	56,65	1	7591

### BOCA CADENA

Alicates con boca semirredonda y punta curvada de 60° ERGO™ con mango sintético bi-componente



ergo



**RX 7892**

AI		€		
29 mm	M	46,35	10	RX 7892

Alicates de boca semirredonda con mango sintético bi-componente



**7890-7891**

AI		€		
32.5 mm	M	56,65	10	7890
32.5 mm	M	59,23	10	7891
32.5 mm	M	59,23	10	7890 CO
32.5 mm	M	56,65	10	7891 CO

### ALICATE PARA CREAR CADENAS DE JOYERIA

ERGO™ Alicate plano de precisión de punta recta para cadenas con mango sintético



ergo



**RX 7390**

AI		€		
11 mm	S	66,95	10	RX 7390

Alicates de boca semirredonda ERGO™ con mango sintético bi-componente



ergo



**RX 7890-RX 7891**

AI		€		
32 mm	S	46,35	10	RX 7890
32 mm	S	46,35	10	RX 7891

ERGO™ Alicate plano de precisión de punta oblicua para cadenas con mango sintético



ergo



**RX 7392**

AI		€		
12 mm	S	66,95	10	RX 7392



## BOCA DOBLADA

Alicates de boca semirredonda de punta curvada de 60° con mango sintético



**7892**



		€		
20 mm	M	43,77	10	7892
20 mm	M	43,77	10	7892 CO

## BOCA SEMIRREDONDA, CABEZA ESPECIAL

Alicates de boca semirredonda dentada corta con mango sintético



**7893K**



		€		
20 mm	S	46,35	10	7893K

## BOCA SEMIRREDONDA, CABEZA ESPECIAL

Alicates de boca semirredonda corta ERGO™ con mango sintético bi-componente



ergo®



**RX 7893**



		€		
20 mm	S	46,35	10	RX 7893

## BOCA AGUJA

Alicates de precisión ERGO™ de boca semirredonda y punta fina



ergo®



**RX 7894**



	€		
L	54,08	10	RX 7894

Alicates de boca semirredonda corta con mango sintético



**7893**



		€		
20 mm	S	43,77	10	7893

Alicates de precisión de boca semirredonda y punta fina y mango de seguridad ESD



**7894**



	€		
L	51,50	10	7894

## PELACABLES

### ALICATES CORTE DIAGONAL

Alicates de corte diagonal de precisión con cabeza ovalada- Accesorio para pelado y mango de seguridad ESD



**8150SK**



		€		
0.01-0.06 / 0.3-1.6	Micro-Bevel®	77,25	10	8150 SK

Alicates de corte diagonal con corte ovalado o cabeza para pelado y mangos de seguridad ESD



**8150J-8160J**



		€		
0.02 / 0.5	Micro-Bevel®	77,25	10	8150 J
Max0.02 / Max	Micro-Bevel®	87,55	10	8160 J

## HERRAMIENTAS DINAMOMÉTRICAS

### DESTORNILLADORES DINAMOMÉTRICOS

Destornilladores dinámicos ajustables con visor de escala y seguridad ESD



#### MA500-1A - MA500-3A

Scale	Hex Size	€	Box	Fish
16-80 cNM	1/4 in	281,46	1	MA500-1A
40-200 cNM	1/4 in	287,99	1	MA500-2A
90-450 cNM	1/4 in	294,31	1	MA500-3A

Destornilladores dinámicos preajustados con visor de escala y seguridad ESD



#### PS501

Scale	Hex Size	€	Box	Fish
4-22 cNM	1/4 in	203,76	1	PS501-1
7-70 cNM	1/4 in	226,98	1	PS501-2
15-170 cNM	1/4 in	234,73	1	PS501-3
45-450 cNM	1/4 in	241,17	1	PS501-4

## PINZAS

### JUEGOS DE PINZAS

Juego de 5 pinzas estilo SS-SA, 2A-SA, 7A-SA, AA-SA



#### 9855

Dimensions	€	Box	Fish
10 x 200 x 110 mm	103,76	1	9855

#### 9855W

TL SS-SA-SL	
TL AA-SA-SL	
TL 2A-SA-SL	
TL 7A-SA-SL	
TL 4-SA-SL	

Juego de 5 pinzas estilo 00-SA, 1-SA, 3C-SA, 5-SA, 7-SA



#### 9857

Dimensions	€	Box	Fish
10 x 200 x 110 mm	81,08	1	9857

#### TL 00-SA-SL

TL 1-SA-SL	
TL 5-SA-SL	
TL 7-SA-SL	
TL 3C-SA-SL	

#### 9855W

Juego de 2 pinzas estilo AA-SA, SS-SA



#### 9858

Dimensions	€	Box	Fish
8 x 200 x 65 mm	30,13	1	9858

#### 9858W

TL AA-SA-SL	
TL SS-SA-SL	

Juego de 2 pinzas estilo 00B-SA, 2A-SA



#### 9859

Dimensions	€	Box	Fish
8 x 200 x 65 mm	69,63	1	9859

#### 9858W

TL 00B-SA	
TL 2A-SA-SL	

Juego de 5 pinzas de alta precisión estilo 00-SA, 2ASA, 3C-SA, 5-SA, 7-SA



#### 9860

Dimensions	€	Box	Fish
12 x 105 x 185 mm	159,36	1	9860

Juego de 5 pinzas gama económica Estilo de punta 00-SA, 2A-SA, 3C-SA, 5-SA, 7-SA



**9861**



10 x 70 x 165 mm

€



70,96

1

9861

Juego de 4 pinzas gama económica estilo 2A-SA, 3C-SA, 7A-SA, AA-SA



**9862**



10 x 70 x 165 mm

€



56,09

1

9862

Juego de 5 pinzas SMD y gama económica Estilo de punta SM103-SA, SM108-SA, 3-SA, 5-SA, 7A-SA



**9863**



10 x 70 x 165 mm

€



95,00

1

9863

## PINZAS DE CORTE

Pinzas de corte de acero al carbono estilo 15A con hojas en ángulo



**TL 15A**



120 mm

€



55,15

1

TL 15A

Pinzas de corte de acero al carbono estilo 15AGW con hojas predominantemente angulares



**TL 15AGW**



115 mm

€



55,06

1

TL 15AGW

Pinzas de corte de acero inoxidable estilo 15AGWHM con insertos de carburo de tungsteno y hojas predominantemente angulares



**TL 15AGWHM-SA**



115 mm

€



93,19

1

TL 15AGWHM-SA

## PINZAS DE PRECISIÓN

Pinzas de acero inoxidable de alta precisión estilo 00B con mangos dentados y puntas gruesas y resistentes



**TL 00B-SA**



120 mm

€



43,74

1

TL 00B-SA

Pinzas de acero inoxidable de alta precisión estilo 00D con mangos dentados, gruesas, fuertes, puntas dentadas de línea



**TL 00D-SA**



120 mm

€



43,74

1

TL 00D-SA

Acero inox, anti-magnético, anti-ácido

Pinzas de acero inoxidable de alta precisión estilo 00 con puntas gruesas y resistentes



**TL 00-SA**



120 mm

€



39,41

1

TL 00-SA

Acero inox, anti-magnético, anti-ácido

Pinzas de acero inoxidable de alta precisión estilo 000 con puntas finas



**TL 000-SA**

		€		
000	120 mm	31,92	1	TL 000-SA

Pinzas de acero inoxidable de alta precisión estilo 2A con puntas muy finas, redondas y planas



**TL 2A-SA**

		€		
2A	120 mm	38,62	1	TL 2A-SA

Acero inox, anti-magnético, anti-ácido

Pinzas de acero inoxidable de alta precisión estilo 51S con puntas dobladas y muy finas



**TL 51S-SA**

		€		
51S	115 mm	42,45	1	TL 51S-SA

Acero inox, anti-magnético, anti-ácido

Pinzas de acero inoxidable de alta precisión estilo 0C9 con puntas finas y afiladas



**TL 0C9-SA**

		€		
0C9	90 mm	37,80	1	TL 0C9-SA

Acero inox, anti-magnético, anti-ácido

Pinzas de acero inoxidable de alta precisión estilo 3C con puntas finas y puntiagudas



**TL 3C-SA**

		€		
3C	110 mm	37,80	1	TL 3C-SA

Acero inox, anti-magnético, anti-ácido

Pinzas de acero inoxidable de alta precisión estilo 5 con puntas afiladas muy finas



**TL 5-SA**

		€		
5	110 mm	45,82	1	TL 5-SA

Pinzas de acero inoxidable de alta precisión estilo 1 con puntas finas y afiladas



**TL 1-SA**

		€		
1	120 mm	37,80	1	TL 1-SA

Acero inox, anti-magnético, anti-ácido

Pinzas de acero inoxidable de alta precisión estilo 3 con puntas finas y puntiagudas



**TL 3-SA**

		€		
3	120 mm	37,80	1	TL 3-SA

Acero inox, anti-magnético, anti-ácido

Pinzas de acero inoxidable de alta precisión estilo SS con puntas muy finas y muy afiladas



**TL SS-SA**

		€		
SS	140 mm	37,80	1	TL SS-SA

Acero inox, anti-magnético, anti-ácido

Pinzas de acero inoxidable de alta precisión estilo 7A con puntas muy finas y curvadas



### TL 7A-SA

		€		
7A	118 mm	49,20	1	TL 7A-SA

Acero inox, anti-magnético, anti-ácido

Pinzas de acero inoxidable de alta precisión estilo 65A con puntas dobladas, muy finas y muy afiladas



### TL 65A-SA

		€		
65A	140 mm	44,14	1	TL 65A-SA

Acero inox, anti-magnético, anti-ácido

Pinzas de acero inoxidable de alta precisión estilo 7 con puntas muy finas y curvadas



### TL 7-SA

		€		
7	118 mm	49,20	1	TL 7-SA

Acero inox, anti-magnético, anti-ácido

Pinzas de acero inoxidable de alta precisión estilo 34A con mangos dentados y puntas planas, finas y cuadradas



### TL 34A-SA

		€		
34A	120 mm	41,75	1	TL 34A-SA

Pinzas de acero inoxidable de alta precisión estilo 6 con puntas anguladas y muy finas



### TL 5B-SA

		€		
5B	110 mm	49,20	1	TL 5B-SA

Acero inox, anti-magnético, anti-ácido

### TL 6-SA

		€		
6	117 mm	41,75	1	TL 6-SA

## PINZAS DE PLÁSTICO DE PUNTA REEMPLAZABLE - FIBRA DE CARBONO

Pinzas de plástico de fibra de carbono de punta reemplazable ESD Safe Style 242CFR con puntas finas



### TL 242CFR-SA

		€		
242CFR	130 mm	27,66	1	TL 242CFR-SA

Pinzas de plástico de fibra de carbono con punta reemplazable y segura para ESD, estilo 249CFR, con puntas gruesas, biseladas y resistentes



### TL 249CFR-SA

		€		
249CFR	130 mm	51,69	1	TL 249CFR-SA

Cuerpo de acero inox

Pinzas de plástico de fibra de carbono con punta reemplazable y segura para ESD, estilo 259CFR, con puntas finas, puntiagudas y fuertes



### TL 259CFR-SA

		€		
259CFR	130 mm	51,69	1	TL 259CFR-SA

Cuerpo de acero inox



Pinzas de plástico PEEK de carbono con punta reemplazable y segura para ESD, estilo 259CPR con puntas finas, puntiagudas y fuertes



### TL 259CPR-SA

		€		
259CPR	130 mm	28,95	1	TL 259CPR-SA

Pinzas de plástico de fibra de carbono de punta reemplazable ESD segura estilo 2ACFR con puntas planas muy finas y redondas



### TL 2ACFR-SA

		€		
2ACFR	130 mm	51,69	1	TL 2ACFR-SA

Cuerpo de acero inox

Pinzas de plástico de carbono PEEK con punta reemplazable y segura ESD estilo 5CPR con puntas muy finas y afiladas



### TL 5CPR-SA

		€		
5CPR	130 mm	28,95	1	TL 5CPR-SA

Pinzas de plástico de fibra de carbono de punta reemplazable ESD Safe Style 00CFR con puntas gruesas y cuadradas



### TL 00CFR-SA

		€		
00CFR	130 mm	51,69	1	TL 00CFR-SA

Cuerpo de acero inox

Pinzas de plástico de fibra de carbono con punta reemplazable y segura ESD estilo 5CF con puntas muy finas y afiladas



### TL 5CF-SA

		€		
5CF	130 mm	26,49	1	TL 5CF-SA

Pinzas de plástico de PVDF con punta reemplazable y seguridad ESD estilo 5SV con puntas muy finas y afiladas



### TL 5SVR-SA

		€		
5SVR	130 mm	28,95	1	TL 5SVR-SA

Pinzas de plástico de PVDF con punta reemplazable y segura para ESD, estilo 259SVR con puntas finas, puntiagudas y fuertes



### TL 259SVR-SA

		€		
259SVR	130 mm	43,45	1	TL 259SVR-SA

Pinzas de plástico de fibra de carbono con punta reemplazable y segura ESD estilo 5CFR con puntas muy finas y afiladas



### TL 5CFR-SA

		€		
5CFR	130 mm	51,69	1	TL 5CFR-SA

Cuerpo de acero inox

Pinzas de plástico PEEK de carbono con punta reemplazable y segura para ESD, estilo 7CPR con puntas muy finas y curvadas



### TL 7CPR-SA

		€		
7CPR	130 mm	28,95	1	TL 7CPR-SA

Pinzas de plástico de PVDF con punta reemplazable y segura para ESD estilo 7SVR con puntas muy finas y curvadas



### TL 7SVR-SA

		€		
7SVR	130 mm	28,95	1	TL 7SVR-SA

Pinzas de plástico de fibra de carbono con punta reemplazable y segura ESD estilo 7CFR con puntas muy finas y curvadas



### TL 7CFR-SA

		€		
7CFR	130 mm	51,69	1	TL 7CFR-SA

Cuerpo acero inox

## PINZAS TÁCTILES ERGONÓMICAS CON SEGURIDAD ESD

Pinzas ergonómicas de acero inoxidable ESD estilo 00 con puntas gruesas y resistentes



### TL 00-SA-ET

		€		
00-SA	123 mm	46,46	1	TL 00-SA-ET

Pinzas ergonómicas de acero inoxidable ESD estilo 2A con puntas redondas, planas y muy finas



### TL 2A-SA-ET

		€		
2A-SA	123 mm	35,29	1	TL 2A-SA-ET

Pinzas ergonómicas de acero inoxidable ESD Style 3 con puntas afiladas y finas



### TL 3-SA-ET

		€		
3	123 mm	46,46	1	TL 3-SA-ET

Pinzas ergonómicas de acero inoxidable ESD estilo 3C con puntas puntiagudas y finas



### TL 3C-SA-ET

		€		
3C-SA	112 mm	35,67	1	TL 3C-SA-ET

Pinzas ergonómicas de acero inoxidable ESD Style 5 con puntas afiladas y finas



### TL 5-SA-ET

		€		
5-SA	112 mm	39,28	1	TL 5-SA-ET

Pinzas ergonómicas de acero inoxidable ESD estilo AA con puntas afiladas y finas



### TL AA-SA-ET

		€		
AA-SA	130 mm	28,83	1	TL AA-SA-ET

Pinzas ergonómicas ESD de acero inoxidable estilo SM116 con puntas ranuradas para el posicionamiento de dispositivos cilíndricos verticales



### TL SM116-SA-ET

		€		
SM116	115 mm	41,75	1	TL SM116-SA-ET

Pinzas ergonómicas de acero inoxidable ESD estilo 7A con puntas curvas y finas



**TL 7A-SA-ET**

		€		
7A	122 mm	41,23	1	TL 7A-SA-ET

Pinzas gama económica de acero inoxidable estilo 1 con puntas afiladas y finas



**TL 1-SA-SL**

		€		
1	120 mm	18,91	5	TL 1-SA-SL

Pinzas gama económica de acero inoxidable estilo 3C con puntas puntiagudas y finas



**TL 3C-SA-SL**

		€		
3C	110 mm	18,91	5	TL 3C-SA-SL

Pinzas ergonómicas de acero inoxidable ESD Style 7 con puntas curvadas y muy finas



**TL 7-SA-ET**

		€		
7-SA	122 mm	41,23	1	TL 7-SA-ET

Pinzas gama económica de acero inoxidable estilo 2A con puntas redondas planas y finas



**TL 2A-SA-SL**

		€		
2A	118 mm	19,32	5	TL 2A-SA-SL

Pinzas gama económica de acero inoxidable estilo 3 con puntas puntiagudas y finas



**TL 3-SA-SL**

		€		
3	125 mm	18,91	5	TL 3-SA-SL

Puntas muy afiladas

**PINZAS ECONÓMICAS**

Pinzas gama económica de acero inoxidable estilo 00 con puntas gruesas y resistentes



**TL 00-SA-SL**

		€		
00	120 mm	19,68	5	TL 00-SA-SL

Pinzas gama económica de acero inoxidable estilo 2 con puntas puntiagudas y muy finas



**TL 2-SA-SL**

		€		
2	120 mm	19,32	5	TL 2-SA-SL

Pinzas gama económica de acero inoxidable estilo 4 con puntas afiladas y finas



**TL 4-SA-SL**

		€		
4	110 mm	21,01	5	TL 4-SA-SL

Pinzas gama económica de acero inoxidable estilo 5A con puntas afiladas y finas



**TL 5A-SA-SL**

		€		
5A	110 mm	22,93	5	TL 5A-SA-SL

Acero inox, anti-magnético, anti-ácido

Pinzas gama económica de acero inoxidable estilo SS con puntas muy afiladas y finas



**TL SS-SA-SL**

		€		
SS	140 mm	18,91	5	TL SS-SA-SL

Pinzas gama económica de acero inoxidable estilo 7A con puntas curvas y finas



**TL 7A-SA-SL**

		€		
7A	120 mm	24,79	5	TL 7A-SA-SL

Acero inox, anti-magnético, anti-ácido

Pinzas gama económica de acero inoxidable estilo 5A con puntas afiladas y finas



**TL 5-SA-SL**

		€		
5	110 mm	22,93	5	TL 5-SA-SL

Acero inox, anti-magnético, anti-ácido

Pinzas gama económica de acero inoxidable estilo AA con puntas afiladas y finas



**TL AA-SA-SL**

		€		
AA	128 mm	11,55	5	TL AA-SA-SL

Acero inox, anti-magnético, anti-ácido

Pinzas gama económica de acero inoxidable estilo 7 con puntas curvas y finas



**TL 7-SA-SL**

		€		
7	120 mm	24,59	5	TL 7-SA-SL

Pinzas gama económica de acero inoxidable estilo AC con mangos dentados y puntas resistentes



**TL AC-SA-SL**

		€		
AC	110 mm	18,95	5	TL AC-SA-SL

Pinzas gama económica de acero inoxidable estilo MM con puntas afiladas, fuertes y finas



**TL MM-SA-SL**

		€		
MM	125 mm	11,55	5	TL MM-SA-SL

Acero inox, anti-magnético, anti-ácido

**PINZAS SMD**

Pinzas de acero inoxidable estilo SMD 104 para posicionar paquetes SOT y condensadores de chip monolíticos



**TL SM104-SA**

		€		
SM104	120 mm	41,46	1	TL SM 104-SA

Pinzas de acero inoxidable estilo SMD 105 con puntas en forma de martillo para el posicionamiento de paquetes SOT verticales



**TL SM105-SA**

		€		
SM105	120 mm	41,46	1	TL SM 105-SA

Acero inox, anti-magnético, anti-ácido

Pinzas de acero inoxidable estilo SMD 109 para soldar componentes de 1 mm de ancho en ángulo de 45°



**TL SM109-SA**

		€		
SM109	120 mm	41,46	1	TL SM 109-SA

Acero inox, anti-magnético, anti-ácido

Pinzas de acero inoxidable estilo SMD 116 con puntas ranuradas para el posicionamiento de dispositivos cilindricos verticales



**TL SM116-SA**

		€		
SM116	115 mm	24,42	1	TL SM116-SA

Pinzas de acero inoxidable estilo SMD 106 con puntas finas para el posicionamiento de paquetes SOT horizontales



**TL SM106-SA**

		€		
SM106	120 mm	24,42	1	TL SM106-SA

Pinzas de acero inoxidable estilo SMD 110 con puntas ranuradas para el posicionamiento de dispositivos cilindricos



**TL SM110-SA**

		€		
SM110	120 mm	41,46	1	TL SM 110-SA

Acero inox, anti-magnético, anti-ácido

Pinzas de acero inoxidable estilo SMD 107 con puntas doblemente dobladas para posicionar dispositivos planos



**TL SM107-SA**

		€		
SM107	120 mm	41,46	1	TL SM 107-SA

Acero inox, anti-magnético, anti-ácido

Pinzas de acero inoxidable estilo SMD 108 para soldar componentes de 1 mm de ancho



**TL SM108-SA**

		€		
SM108	120 mm	41,46	1	TL SM 108-SA

Pinzas de acero inoxidable estilo SMD 111 con puntas ranuradas para posicionar dispositivos cilindricos de 0,5 mm



**TL SM111-SA**

		€		
SM111	115 mm	41,46	1	TL SM 111-SA

Acero inox, anti-magnético, anti-ácido

Pinzas de acero inoxidable estilo SMD 103 para manipular y posicionar en ángulo de 45°



**TL SM103-SA**

		€		
SM103	115 mm	41,46	1	TL SM 103-SA





Pinzas de acero inoxidable estilo SMD 115 con puntas acanaladas a 45° para posicionar dispositivos cilíndricos de 0,6 mm



### TL SM115-SA

		€		
SM115	115 mm	41,46	1	TL SM 115-SA

Acero inox, anti-magnético, anti-ácido

Pinzas de acero inoxidable estilo SMD 117 con puntas cuadradas en ángulo de 20° para posicionar paquetes SOT



### TL SM117-SA

		€		
SM117	120 mm	41,46	1	TL SM 117-SA

Acero inox, anti-magnético, anti-ácido

## COMPONENTES PINZAS DE POSICIONAMIENTO

Pinzas de posicionamiento con componentes de acero inoxidable estilo 578 con mangos dentados y puntas ranuradas para dispositivos cilíndricos de 2 mm



### TL 578-SA

		€		
578	120 mm	33,83	1	TL 578-SA

Acero inox, anti-magnético, anti-ácido

Pinzas de posicionamiento con componentes de acero inoxidable estilo 582 con mangos dentados y puntas ranuradas para dispositivos cilíndricos de 1 mm



### TL 582-SA

		€		
582	115 mm	33,83	1	TL 582-SA

Acero inox, anti-magnético, anti-ácido

## PINZAS UNIVERSALES

Pinzas de acero inoxidable de uso general estilo 475 con mangos dentados y puntas biseladas, fuertes y dentadas de línea



### TL 475-SA

		€		
475	136 mm	38,53	1	TL 475-SA

Anti-magnético, anti-ácido

Pinzas de acero inoxidable de uso general estilo 648 con mangos dentados y puntas biseladas, gruesas, fuertes y afiladas



### TL 648-SA

		€		
648	155 mm	34,54	1	TL 648-SA

Con un pin para mejor alineamiento Acero inox, antimagnético, anti-ácido

Pinzas de acero inoxidable de uso general estilo 124 con mangos dentados y puntas dobladas, dentadas en forma de rombo, finas



### TL 124-SA

		€		
124	150 mm	32,52	1	TL 124-SA

Acero inox, anti magnético, anti ácido

Pinzas de acero inoxidable de uso general estilo 649 con mangos dentados y puntas dobladas, biseladas, gruesas y fuertes, dentadas en línea



### TL 649-SA

		€		
649	154 mm	34,44	1	TL 649-SA

Acero inox, anti-magnética, anti-ácido

## REPUESTOS Y ACCESORIOS

Juego de 2 tornillos de fibra de carbono y 3 tornillos con puntas rectas, gruesas y resistentes TL 00CFR-SA



### TL 00ACF

		€		
00CFR	40 mm	8,14	1	TL 00ACF

Juego de 2 puntas de fibra de carbono y 3 tornillos con puntas rectas, muy finas, redondas y planas para TL 2ACFR-SA-TL 2AXCFR-SA



**TL 2AACF**



		€		
2A	40 mm	15,61	1	TL 2AACF

Juego de 2 puntas de carbono PEEK y 3 tornillos con puntas rectas, finas, puntiagudas y fuertes para TL 259CPR-SA



**TL 259ACP**

		€		
259CPR	40 mm	109,99	1	TL 259ACP

Juego de 2 puntas de PVDF y 3 tornillos y puntas rectas, muy finas y afiladas para TL 5SVR-SA-TL 5XSVR-SA



**TL 5ASV**

		€		
5SVR	40 mm	109,99	1	TL 5ASV

Juego de 2 puntas de fibra de carbono y 3 tornillos con puntas rectas abd finas para TL 242CFR-SA



**TL 242ACF**

		€		
242CFR	40 mm	8,14	1	TL 242ACF

Juego de 2 puntas de PVDF y 3 tornillos con puntas rectas, finas, puntiagudas y fuertes para TL 259SVR-SA



**TL 259ASV**

		€		
259ASV	40 mm	13,42	1	TL 259ASV

Juego de 2 puntas de fibra de carbono y 3 tornillos con puntas rectas, muy finas y afiladas para TL 5CFR-SA-TL 5XCFR-SA



**TL 5ACF**



		€		
5CF	40 mm	15,61	1	TL 5ACF

Juego de 2 puntas de fibra de carbono y 3 tornillos con puntas rectas, gruesas, biseladas y resistentes para TL 249CFR-SA



**TL 249ACF**



		€		
249CFR	40 mm	15,61	1	TL 249ACF

Juego de 2 puntas de fibra de carbono y 3 tornillos con puntas rectas, finas, puntiagudas y fuertes para TL 259CFR-SA



**TL 259ACF**



		€		
259CFR	40 mm	15,61	1	TL 259ACF

Juego de 2 puntas de fibra de carbono y 3 tornillos con puntas curvas y muy finas para TL 7CFR-SA



**TL 7ACF**



		€		
7CFR	40 mm	15,61	1	TL 7ACF

Juego de 2 puntas de PVDF y 3 tornillos con puntas curvas y muy finas para TL 7SVR-SA



**TL 7ASV**

		€		
7SVR	40 mm	109,99	1	TL 7ASV

Juego de 2 puntas de carbono PEEK y 3 tornillos con puntas rectas, muy finas y afiladas para TL 5CPR-SA-TL 5XCPR-SA



**TL 5ACP**

		€		
5CPR	40 mm	109,99	1	TL 5ACP

Juego de 2 puntas de carbono PEEK y 3 tornillos con puntas curvas y muy finas para TL 7CPR-SA



**TL 7ACP**

		€		
7CPR	40 mm	109,99	1	TL 7ACP



1-100-04-1-0	7311518019006	10	5,67	24
1-100-04-1-2	7311518244125	5	7,12	24
1-100-04-2-0	7311518019013	10	5,08	24
1-100-04-2-2	7311518244132	5	7,26	24
1-100-04-3-0	7311518019020	10	5,28	24
1-100-06-1-0	7311518019037	10	5,28	24
1-100-06-1-2	7311518000233	5	8,99	24
1-100-06-2-0	7311518019044	10	5,64	24
1-100-06-2-2	7311518003593	5	9,07	24
1-100-06-3-0	7311518019051	10	5,85	24
1-100-06-3-2	7311518293581	5	9,06	24
1-100-08-1-0	7311518019068	10	6,84	24
1-100-08-1-2	7311518000264	5	9,84	24
1-100-08-2-0	7311518019075	10	7,26	24
1-100-08-2-2	7311518003609	5	10,31	24
1-100-08-3-0	7311518019082	10	7,37	24
1-100-08-3-2	7311518295585	5	11,46	24
1-100-10-1-0	7311518019099	10	8,93	24
1-100-10-1-2	7311518000295	5	12,70	24
1-100-10-2-0	7311518019105	10	9,34	24
1-100-10-2-2	7311518003616	5	13,10	24
1-100-10-3-0	7311518019112	10	9,49	24
1-100-10-3-2	7311518295592	5	12,43	24
1-100-12-1-0	7311518019129	5	12,20	24
1-100-12-1-2	7311518028053	5	15,67	24
1-100-12-2-0	7311518019136	5	12,47	24
1-100-12-2-2	7311518244118	5	15,94	24
1-100-12-3-0	7311518019143	5	12,62	24
1-100-12-3-2	7311518295608	5	14,66	24
1-100-14-1-0	7311518019150	5	17,44	24
1-100-14-2-0	7311518019167	5	18,26	24
1-102-06-2-0	7311518019198	10	7,95	24
1-102-06-3-0	7311518019204	10	8,37	24
1-102-08-1-0	7311518019211	10	9,49	24
1-102-08-2-0	7311518019228	10	9,84	24
1-102-08-3-0	7311518019235	10	9,96	24
1-104-10-2-0	7311518019242	10	15,34	24
1-104-10-3-0	7311518019259	10	15,88	24
1-104-12-2-0	7311518019266	5	20,51	24
1-104-12-3-0	7311518019273	5	22,03	24
1-104-14-3-0	7311518019297	5	29,83	24
1-106-08-1-0	7311518019303	10	11,23	24
1-106-08-1-2	7311518000301	5	14,74	24
1-106-10-1-0	7311518019310	10	15,63	24
1-106-10-1-2	7311518000325	5	18,87	24
1-106-12-1-0	7311518019327	5	19,95	24
1-106-12-1-2	7311518295615	5	22,77	24
1-110-04-1-0	7311518019334	10	4,83	24
1-110-04-2-0	7311518019341	10	5,08	24
1-110-04-3-0	7311518044046	10	5,28	24
1-110-06-1-0	7311518019358	10	5,28	24
1-110-06-1-2	7311518295622	5	8,99	25
1-110-06-2-0	7311518019365	10	5,64	24
1-110-06-2-2	7311518003623	5	9,07	25
1-110-06-3-0	7311518019372	10	5,85	24
1-110-06-3-2	7311518295639	5	8,97	25
1-110-08-1-0	7311518019389	10	6,84	24
1-110-08-1-2	7311518000332	5	9,84	25
1-110-08-2-0	7311518019396	10	7,26	24
1-110-08-2-2	7311518003630	5	10,31	25
1-110-08-3-0	7311518019402	10	7,37	24
1-110-08-3-2	7311518295646	5	10,39	25
1-110-10-1-0	7311518019419	10	8,93	24
1-110-10-1-2	7311518000349	5	12,70	25
1-110-10-2-0	7311518019426	10	9,34	24
1-110-10-2-2	7311518003647	5	13,10	25
1-110-10-3-0	7311518019433	10	9,49	24
1-110-10-3-2	7311518295653	5	11,92	25
1-110-12-1-0	7311518019440	5	12,20	24
1-110-12-1-2	7311518295660	5	14,47	25
1-110-12-2-0	7311518019457	5	12,47	24
1-110-12-2-2	7311518295677	5	16,87	25
1-110-12-3-0	7311518019464	5	12,62	24
1-110-12-3-2	7311518295684	5	14,85	25
1-110-14-1-0	7311518019488	5	17,44	24
1-111-04-1-0	7311518044053	10	5,28	25
1-111-04-2-0	7311518019518	10	5,57	25
1-111-04-3-0	7311518019525	10	5,77	25
1-111-06-1-0	7311518019549	10	5,77	25
1-111-06-2-0	7311518019556	10	6,61	25
1-111-06-2-2	7311518000363	5	10,20	25
1-111-06-3-0	7311518019563	10	6,84	25
1-111-08-1-0	7311518019570	10	8,08	25
1-111-08-2-0	7311518019587	10	9,15	25
1-115-11-3-1	7311518003791	10	10,76	25
1-143-04-1-0	7311518105983	10	4,38	25
1-143-06-1-0	7311518019631	10	4,76	25
1-143-06-1-2	7311518022341	5	8,79	25
1-143-08-1-0	7311518019662	10	6,14	25
1-143-08-1-2	7311518028077	5	10,11	25
1-143-10-1-0	7311518019693	10	8,08	25
1-143-10-1-2	7311518022358	5	12,06	25
1-143-12-1-0	7311518019723	5	11,02	25
1-143-12-1-2	7311518295691	5	15,19	25
1-160-04-1-0	7311518019785	10	5,75	26
1-160-04-1-2	7311518244057	5	8,12	26



1-160-04-2-0	7311518019792	10	6,00	26
1-160-04-2-2	7311518244095	5	8,49	26
1-160-04-3-0	7311518019808	10	6,14	26
1-160-06-1-0	7311518019815	10	5,54	26
1-160-06-1-2	7311518000370	5	8,93	26
1-160-06-2-0	7311518019822	10	5,96	26
1-160-06-2-2	7311518003685	5	8,99	27
1-160-06-3-0	7311518019839	10	6,19	26
1-160-06-3-2	7311518295707	5	9,40	27
1-160-08-1-0	7311518019846	10	6,64	26
1-160-08-1-2	7311518000394	5	10,05	27
1-160-08-2-0	7311518019853	10	6,96	26
1-160-08-2-2	7311518003692	5	10,48	27
1-160-08-3-0	7311518019860	10	7,12	26
1-160-08-3-2	7311518295714	5	12,02	27
1-160-10-1-0	7311518019877	10	9,41	26
1-160-10-1-2	7311518000400	5	12,42	27
1-160-10-2-0	7311518019884	10	9,89	26
1-160-10-2-2	7311518295721	5	13,26	27
1-160-10-3-0	7311518019891	10	10,05	26
1-160-10-3-2	7311518295738	5	14,64	27
1-160-12-1-0	7311518019907	5	13,52	26
1-160-12-1-2	7311518295745	5	17,89	27
1-160-12-2-0	7311518019914	5	14,08	26
1-160-12-2-2	7311518295752	5	17,53	27
1-160-12-3-0	7314150292059	5	16,58	26
1-160-12-3-2	7311518298005	5	17,69	27
1-170-04-1-0	7311518044060	10	5,56	26
1-170-04-2-0	7311518019945	10	5,59	26
1-170-04-2-2	7311518244088	5	8,99	26
1-170-04-3-0	7311518019952	10	5,96	26
1-170-06-1-0	7311518019969	10	6,25	26
1-170-06-1-2	7311518244071	5	9,24	26
1-170-06-2-0	7311518019976	10	6,65	26
1-170-06-2-2	7311518003715	5	9,72	26
1-170-06-3-0	7311518019983	10	6,84	26
1-170-06-3-2	7311518295769	5	11,04	26
1-170-08-1-0	7311518019990	10	8,24	26
1-170-08-1-2	7311518000417	5	11,64	26
1-170-08-2-0	7311518020002	10	8,72	26
1-170-08-2-2	7311518003722	5	12,06	26
1-170-08-3-0	7311518020019	10	8,93	26
1-170-08-3-2	7311518295783	5	14,34	26
1-170-10-1-0	7311518020026	10	11,64	26
1-170-10-1-2	7311518028107	5	15,01	26
1-170-10-2-0	7311518020033	10	12,13	26
1-170-10-2-2	7311518244064	5	15,04	26
1-170-10-3-0	7311518020040	10	12,42	26
1-170-10-3-2	7311518295806	5	18,29	26
1-170-12-1-0	7311518020057	5	15,04	26
1-170-12-2-0	7311518020064	5	16,30	26
1-210-04-1-0	7311518020071	10	8,30	25
1-210-04-1-2	7311518243944	5	10,31	26
1-210-04-2-0	7311518020088	10	8,37	25
1-210-04-2-2	7311518244040	5	10,31	26
1-210-04-3-0	7311518020095	10	8,49	25
1-210-06-1-0	7311518020101	10	8,49	25
1-210-06-1-2	7311518000424	5	10,75	26
1-210-06-2-0	7311518020118	10	8,72	25
1-210-06-2-2	7311518003654	5	10,95	26
1-210-06-3-0	7311518020125	10	8,86	25
1-210-06-3-2	7311518293574	5	11,64	26
1-210-08-1-0	7311518020132	10	10,48	25
1-210-08-1-2	7311518000455	5	12,34	26
1-210-08-2-0	7311518020149	10	10,67	25
1-210-08-2-2	7311518000479	5	13,26	26
1-210-08-3-0	7311518020156	10	10,88	25
1-210-08-3-2	7311518295837	5	12,02	26
1-210-10-1-0	7311518020163	10	12,75	25
1-210-10-1-2	7311518000493	5	16,61	26
1-210-10-2-0	7311518020170	10	13,16	25
1-210-10-2-2	7311518003661	5	17,44	26
1-210-10-3-0	7311518020187	10	13,45	25
1-210-10-3-2	7311518295844	5	14,64	26
1-210-12-1-0	7311518020194	5	18,97	25
1-210-12-1-2	7311518028121	5	22,36	26
1-210-12-2-0	7311518020200	5	19,38	25
1-210-12-2-2	7311518244149	5	22,61	26
1-210-12-3-0	7311518020217	5	19,65	25
1-210-12-3-2	7311518295851	5	24,21	26
1-210-14-1-0	7311518020224	5	26,20	25
1-230-04-1-0	7311518020248	10	4,96	26
1-230-04-1-2	7311518244163	5	6,85	26
1-230-04-2-0	7311518020255	10	5,23	26
1-230-04-2-2	7311518244156	5	7,17	26
1-230-04-3-0	7311518020262	10	5,37	26
1-230-06-1-0	7311518020279	10	5,57	26
1-230-06-1-2	7311518000509	5	8,12	26
1-230-06-2-0	7311518020286	10	5,85	26
1-230-06-2-2	7311518000523	5	8,29	26
1-230-06-3-0	7311518020293	10	5,96	26
1-230-06-3-2	7311518293567	5	7,96	26
1-230-08-1-0	7311518020309	10	6,61	26
1-230-08-1-2	7311518000547	5	9,15	26
1-230-08-2-0	7311518020316	10	7,02	26
1-230-08-2-2	7311518000554	5	9,49	26

\* Hasta agotar existencias



1-230-08-3-0	7311518020323	10	7,33	26
1-230-08-3-2	7311518295882	5	9,19	26
1-230-10-1-0	7311518020330	10	8,08	26
1-230-10-1-2	7311518000578	5	11,59	26
1-230-10-2-0	7311518020347	10	8,99	26
1-230-10-2-2	7311518003678	5	12,13	26
1-230-10-3-0	7311518020354	10	9,63	26
1-230-10-3-2	7311518295899	5	11,87	26
1-230-12-1-0	7311518020361	5	11,23	26
1-230-12-1-2	7311518295912	5	14,32	26
1-230-12-2-0	7311518020378	5	11,87	26
1-230-12-2-2	7311518295929	5	14,32	26
1-230-12-3-0	7311518020385	5	12,06	26
1-230-12-3-2	7311518295905	5	13,76	26
1-320-08-2-0	7311518191276	10	18,26	25
1-320-08-2-2	7311518270865	5	22,09	25
1-320-10-2-0	7311518020477	10	20,22	25
1-320-10-2-2	7311518270872	5	24,11	25
1-320-12-2-0	7311518020484	5	22,29	25
1-473-06-2-2	7311518201098	5	29,32	27
1-473-08-2-2	7311518201104	5	33,86	27
1-473-10-2-2	7311518201111	5	39,88	27
1-476-04-3-2	7311518010928	1	50,57	27
1-477-08-2-2	7311518037994	5	59,82	27
1-477-10-2-2	7311518201074	5	71,86	27
1-478-08-1-2	7311518141127	5	54,21	28
1-478-10-1-2	7311518241995	5	64,52	28
1-479-08-1-2	7311518176747	5	63,71	28
1-479-08-2-2	7311518180607	5	64,79	28
10-21-51	7311518229344	5	15,95	618
10-24-23	7311518229368	5	17,14	618
10-24-51	7311518229351	5	17,13	618
10-30-23	7311518229382	5	19,37	618
10-30-51	7311518229375	5	20,85	618
1016	7314150218189	10	4,83	224
1019	8412814010199	10	4,77	224
1031-10	7314150025442	5	27,48	559
1031-12	7314150025459	5	28,19	559
1031-14	7314150025466	5	28,75	559
1031-16	7314150025473	5	29,30	559
1031-18	7314150025480	5	29,99	559
1031-20	7314150025497	5	30,70	559
1031-22	7314150025503	5	31,37	559
1031-25	7314150025510	5	32,22	559
1031-28	7314150025527	5	33,20	559
1031-30	7314150025534	5	33,87	559
1031-32	7314150025541	5	34,58	559
1031-4	7314150025411	5	25,54	559
1031-40	7314150025558	5	37,07	559
1031-6	7314150025428	5	26,11	559
1031-8	7314150025435	5	26,66	559
1067	8412814010670	10	3,59	224
1084	7311518277291	5	89,65	274
10RM-10	7314153014351	60	20,38	47
10RM-13	7314153014368	60	23,12	47
10RM-14	7314150221677	60	23,50	47
10RM-17	7314153014375	30	27,34	47
10RM-19	7314153014382	30	29,97	47
10RM-8	7314153014344	60	18,12	47
10RM/SH6	7314150222971	1	148,00	48
10RZ-1/2	7314150358786	1	24,16	47
10RZ-11/16	7314150358816	1	29,99	47
10RZ-3/4	7314150358823	1	32,45	47
10RZ-3/8	7314150358762	1	21,56	47
10RZ-5/16	7314150358748	1	19,82	47
10RZ-5/8	7314150358809	1	28,53	47
10RZ-7/16	7314150358779	1	22,50	47
10RZ-9/16	7314150358793	1	25,41	47
111M-10	7314151828653	10	7,48	42
111M-100	7314150401499	1	737,33	42
111M-11	7314151828660	10	8,13	42
111M-12	7314151828677	10	8,58	42
111M-13	7314151828684	10	9,03	42
111M-14	7314151828691	10	9,40	42
111M-15	7314151828707	10	9,74	42
111M-16	7314151828714	10	10,30	42
111M-17	7314151828721	10	11,01	42
111M-18	7314151828738	10	11,61	42
111M-19	7314151828745	10	13,27	42
111M-20	7314151828752	10	13,42	42
111M-21	7314151828769	10	15,34	42
111M-22	7314151828776	5	15,47	42
111M-23	7314151828783	5	16,38	42
111M-24	7314151828790	5	17,13	42
111M-25	7314151828806	5	18,58	42
111M-26	7314151828813	5	22,05	42
111M-27	7314151828820	5	24,26	42
111M-28	7314151828837	5	25,91	42
111M-29	7314151828844	5	26,56	42
111M-30	7314151828851	5	29,55	42
111M-32	7314151828868	5	31,85	42
111M-33	7314150222223	5	34,26	42
111M-34	7314151828875	5	36,86	42
111M-36	7314150135516	1	52,10	42
111M-38	7314150222230	1	61,61	42
111M-41	7314150135523	1	66,15	42



111M-46	7314150135530	1	87,23	42
111M-5.5	7314151828608	10	6,58	42
111M-50	7314150135547	1	98,80	42
111M-55	7314150135554	1	172,28	42
111M-6	7314151828615	10	5,98	42
111M-60	7314150135561	1	228,55	42
111M-65	7314150135578	1	304,35	42
111M-7	7314151828622	10	6,05	42
111M-70	7314150135585	1	361,78	42
111M-75	7314150135592	1	455,95	42
111M-8	7314151828639	10	6,22	42
111M-80	7314150135608	1	526,01	42
111M-85	7314150352999	1	707,62	42
111M-9	7314151828646	10	7,43	42
111M-90	7314150401475	1	716,11	42
111M-95	7314150401482	1	718,23	42
111M/11T	7314151828899	1	111,12	44
111M/14T	7314151828905	1	204,98	44
111M/17T	7314151828912	1	177,40	44
111M/17TL	7314150197859	1	228,36	44
111M/24T	7314150197866	1	375,14	44
111M/26T	7314151828929	1	392,04	44
111M/S10	7314150212965	1	97,45	44
111M/SH12	7314153013347	1	123,62	43
111M/SH5	7314150325252	1	47,01	43
111M/SH8	7314150197873	1	86,79	43
111Z-1	7314151829063	3	19,47	43
111Z-1.1/16	7314151829070	5	25,25	43
111Z-1.1/2	7314150135752	1	56,83	43
111Z-1.1/4	7314151829094	5	33,01	43
111Z-1.1/8	7314151829087	5	26,98	43
111Z-1.11/16	7314150135615	1	88,70	43
111Z-1.13/16	7314150135639	1	88,52	43
111Z-1.3/4	7314150135622	1	95,17	43
111Z-1.3/8	7314150135738	1	54,09	43
111Z-1.5/16	7314151829100	5	38,42	43
111Z-1.5/8	7314150135769	1	68,68	43
111Z-1.7/16	7314150135745	1	54,09	43
111Z-1.7/8	7314150135646	1	101,23	43
111Z-1/2	7314151828981	5	9,46	43
111Z-1/4	7314151828943	5	6,25	43
111Z-11/16	7314151829018	5	11,43	43
111Z-13/16	7314151829032	5	15,91	43
111Z-15/16	7314151829056	3	18,02	43
111Z-2	7314150135653	1	102,61	43
111Z-2.1/2	7314150135721	1	309,19	43
111Z-2.1/4	7314150135691	1	180,51	43
111Z-2.1/8	7314150135677	1	180,51	43
111Z-2.3/4	7314150135783	1	328,87	43
111Z-2.3/8	7314150135707	1	249,48	43
111Z-2.5/8	7314150135776	1	309,19	43
111Z-2.7/8	7314150135790	1	399,16	43
111Z-3	7314150135806	1	399,16	43
111Z-3/4	7314151829025	5	13,69	43
111Z-3/8	7314151828967	5	7,85	43
111Z-5/16	7314151828950	5	6,46	43
111Z-5/8	7314151829001	5	10,80	43
111Z-7/16	7314151828974	5	8,55	43
111Z-7/8	7314151829049	5	16,18	43
111Z-9/16	7314151828998	5	9,96	43
111Z/11T	7314151829124	1	158,39	45
111Z/8T	7314151829117	1	98,74	44
1150-1/2H/P	7314150129263	1	61,05	533
1150D	7311518276614	1	74,25	533
1154	7314150249831	1	145,71	321
1154-DG	7314150249800	1	79,41	321
1154-MB	7314150249817	1	58,89	321
1157	7311518277031	60	14,23	592
1162N-1/2	7314151847241	1	24,06	526
1177-SCRIBE	7314150120550	5	6,73	531
1178-SCRIBE	7314150120567	5	7,53	531
1179-FLX	7311518276997	25	2,79	531
1179-SCRIBE	7314150120574	5	22,08	531
1179-TIPS	7314150120581	1	7,65	531
11M-10	7314151829155	5	12,36	45
11M-11	7314151829162	5	12,36	45
11M-12	7314151829179	5	14,14	45
11M-13	7314151829186	5	14,14	45
11M-14	7314151829193	5	17,07	45
11M-15	7314151829209	5	17,07	45
11M-16	7314151829216	5	18,73	45
11M-17	7314151829223	5	19,32	45
11M-18	7314151829230	5	19,46	45
11M-19	7314151829247	5	24,46	45
11M-21	7314151829254	5	24,46	45
11M-22	7314151829261	5	18,34	45
11M-24	7314151829278	5	31,33	45
11M-27	7314151829285	1	40,63	45
11M-30	7314151829292	1	49,16	45
11M-32	7314151829308	1	49,16	45
11M-36	7314151829315	1	63,20	45
11M-38	7314151829322	1	66,97	45
11M-8	7314151829131	5	11,76	45
11M-9	7314151829148	5	11,76	45
11Z-1*	7314150355303	5	38,53	45
11Z-1/2*	7314150355235	5	12,51	45





11Z-11/16*	7314150355266	5	15,50	45
11Z-13/16*	7314150355280	5	18,19	45
11Z-3/4*	7314150355273	5	17,36	45
11Z-3/8*	7314150355211	5	11,75	45
11Z-5/8*	7314150355259	5	15,50	45
11Z-7/16*	7314150355228	5	12,15	45
11Z-9/16*	7314150355242	5	12,96	45
1300Z-1-1-1/8*	7314153000989	1	71,76	54
1300Z-1/2-9/16*	7314151039998	1	30,06	54
1300Z-1/4-5/16*	7314153000965	1	27,36	54
1300Z-15/16-1*	7314153005656	1	55,03	54
1300Z-19/32-11/16*	7314151040000	1	34,65	54
1300Z-25/32-13/16*	7314153000972	1	51,01	54
1300Z-3/8-7/16*	7314151039981	1	27,36	54
1300Z-5/8-3/4*	7314151040017	1	36,90	54
1300Z-7/8-15/16*	7314153005649	1	42,24	54
1320RM-10-11	7314153014511	60	34,39	49
1320RM-12-13	7314153014528	60	36,68	49
1320RM-14-15	7314153014535	30	40,59	49
1320RM-16-17	7314153014542	30	44,56	49
1320RM-17-19	7314150359196	30	45,92	49
1320RM-18-19	7314153014559	30	47,95	49
1320RM-22-24	7314150221646	30	50,52	49
1320RM-6-7	7314153014498	60	31,98	49
1320RM-8-9	7314153014504	60	32,42	49
1320RM/SH8	7314150229888	1	326,87	49
1320RZ-1/2-9/16	7314153014580	30	46,63	49
1320RZ-1/4-5/16	7314153014566	60	31,98	49
1320RZ-3/4-13/16	7314150359264	30	41,82	49
1320RZ-3/4-7/8	7314150359271	30	41,82	49
1320RZ-3/8-7/16	7314153014573	60	40,76	49
1320RZ-5/16-11/32	7314153015235	60	34,70	49
1320RZ-5/8-11/16	7314150359257	30	26,89	49
1320RZ-7/8-15/16	7314150359288	30	55,34	49
1320SRM-14-19	7314150190355	1	43,20	49
1320SRM/S29*	7314150188673	1	133,99	49
1321RZ-1/2-9/16	7314150359349	1	29,45	49
1321RZ-3/4-7/8	7314150359363	1	48,20	49
1321RZ-3/8-7/16	7314150359332	1	26,13	49
1321RZ-5/8-11/16	7314150359356	1	34,09	49
133SGM-100	7314151828523	1	569,24	57
133SGM-105	7314151828530	1	635,83	57
133SGM-110	7314151828547	1	694,10	57
133SGM-115	7314151828554	1	812,28	57
133SGM-120	7314151828561	1	825,60	57
133SGM-27	7314151828363	1	29,79	57
133SGM-30	7314151828370	1	34,97	57
133SGM-32	7314151828387	1	37,09	57
133SGM-36	7314151828394	1	47,79	57
133SGM-41	7314151828400	1	58,59	57
133SGM-46	7314151828417	1	78,90	57
133SGM-50	7314151828424	1	89,89	57
133SGM-55	7314151828431	1	104,84	57
133SGM-60	7314151828448	1	116,51	57
133SGM-65	7314151828455	1	146,00	57
133SGM-70	7314151828462	1	188,09	57
133SGM-75	7314151828479	1	201,40	57
133SGM-80	7314151828486	1	263,01	57
133SGM-85	7314151828493	1	276,32	57
133SGM-90	7314151828509	1	352,85	57
133SGM-95	7314151828516	1	371,18	57
14-24-3810	7311518002879	5	21,92	619
140	7314150008797	1	56,49	270
141	7314150008827	1	63,53	270
1410	7314150106332	1	79,40	270
1410D	7314150452842	1	88,46	270
1418-4	7314150510863	1	11,98	364
1418-5	7314150510870	1	14,18	364
1418-6	7314150510887	1	15,93	364
1418-7.5	7314150510894	1	18,14	364
1418-8.5	7314150510900	1	21,12	364
1418S	7314151040604	1	179,00	363
1419-M12	7314150257423	1	37,14	363
1419-M16	7314150358045	1	47,15	363
1419-M5	7314150257409	1	29,42	363
1419-M8	7314150257416	1	32,92	363
1419-MD	7311518277352	1	12,34	337
1419/4	7314150125036	1	133,83	363
142	7314150008841	1	85,45	270
1420	7314150103744	1	106,83	270
1420-1.4	7314151696337	1	3,47	363
1420D	7314150452859	1	118,97	270
1421-2.1	7314151696412	1	4,10	363
1422-3.1	7314151696689	1	5,72	363
1423-4.8	7314151696764	1	7,02	363
1424-6.2	7314151696849	1	8,42	363
143	7314150008872	1	139,54	270
1430FT120	7314150342006	1	131,30	377
1435/5	7314151040734	1	29,16	363
1435/8	7314151040741	1	92,13	363
144	7314150008902	1	232,48	270
1446	7314150128631	15	7,36	571
1446-CS	7314150508266	15	7,73	571
1446-FLOAT	7314150438464	15	12,69	571
1446-FLOAT-B	7314150524310	12	6,68	571
1446-OV	7314150313679	15	12,20	571

\* Hasta agotar existencias



1450D-ISO	7314151040970	1	94,08	366
1450D-VVV	7314151040987	1	94,08	366
1450D/2	7314151040963	1	179,81	366
1460M/1	7314151041090	1	2.620,60	365
1460M/2	7314151041106	1	4.470,63	365
1460Z/2	7314151041120	1	6.646,83	365
1467-250	7314150124268	1	63,44	266
1467-320-850	7314150178636	1	266,55	267
1467-520	7314150124275	1	205,94	267
1467-LJ	7314150209033	1	19,75	267
1467-SJ	7314150208982	1	16,03	267
1468-10M10	7314150243457	1	20,24	343
1468-10M4	7314150243419	1	20,24	343
1468-10M5	7314150243426	1	20,24	343
1468-10M6	7314150243433	1	20,24	343
1468-10M8	7314150243440	1	20,24	343
1468-6M3	7314150243372	1	5,17	343
1468-6M4	7314150243389	1	5,17	343
1468-6M5	7314150243396	1	5,17	343
1468-6M6	7314150243402	1	5,17	343
1468-M10	7314150243228	6	264,48	343
1468-M6	7314150243211	1	105,29	343
147	7314150008933	1	448,01	270
147-1	7314150367047	1	41,29	123
147-1.1/4	7314150367061	1	43,88	123
147-1.1/8	7314150367054	1	41,29	123
147-1/2	7314150366965	1	36,13	123
147-11/16	7314150366996	1	36,13	123
147-13	7314150366644	1	32,27	123
147-13/16	7314150367016	1	41,29	123
147-14	7314150366651	1	32,27	123
147-15	7314150366668	1	32,27	123
147-15/16	7314150367030	1	41,29	123
147-16	7314150366675	1	32,27	123
147-17	7314150366682	1	32,27	123
147-18	7314150366699	1	32,27	123
147-19	7314150366705	1	32,27	123
147-21	7314150366712	1	38,71	123
147-22	7314150366729	1	38,71	123
147-24	7314150366736	1	38,71	123
147-25	7314150366743	1	43,88	123
147-27	7314150366750	1	43,88	123
147-3/4	7314150367009	1	36,13	123
147-30	7314150366767	1	43,88	123
147-32	7314150366774	1	43,88	123
147-33	7314150366781	1	47,76	123
147-34	7314150366798	1	47,76	123
147-35	7314150366804	1	47,76	123
147-36	7314150366811	1	47,76	123
147-37	7314150366828	1	50,34	123
147-38	7314150366835	1	50,34	123
147-39	7314150366842	1	50,34	123
147-41	7314150366859	1	50,34	123
147-45	7314150366866	1	178,10	123
147-46	7314150366873	1	178,10	123
147-5/8	7314150366989	1	36,13	123
147-50	7314150366880	1	184,55	123
147-55	7314150366897	1	198,74	123
147-60	7314150366903	1	212,93	123
147-65	7314150366910	1	217,48	123
147-68	7314150366910	1	240,03	123
147-7/16	7314150366958	1	36,13	123
147-7/8	7314150367023	1	41,29	123
147-70	7314150366927	1	240,03	123
147-75	7314150366934	1	281,32	123
147-9/16	7314150366972	1	36,13	123
147-90	7314150366941	1	356,18	123
1470K-AC1	7314150226498	1	105,80	376
1470K-AC2	7314150226504	1	125,64	376
1470K-AC3	7314150226511	1	46,29	376
1470K-AC4	7314150226528	1	52,90	376
1470K-AC7	7314150271320	1	133,47	377
1470K-ACSIDE	7314150226535	1	85,96	376
1470K-ACTD	7314150297269	1	203,37	376
1470K-ACTSS	7314150297283	1	396,74	376
1470K-ACTW	7314150297276	1	246,35	376
1470K7LH	7314150360444	1	804,56	375
1470K7SS	7314150343287	1	2.276,30	514
1470KAC01	7314150165124	1	18,41	424
1470K2C	7314150226696	1	187,08	377
1470K3A	7314150506354	1	203,98	377
1470KCTRAY	7314150226702	1	46,50	377
1470KXL-ACTD	7314150297290	1	260,58	376
1470KXL-ACTSS	7314150297313	1	476,08	376
1470KXL-ACTW	7314150297306	1	388,96	376
1470KXLC-TRAY	7314150285549	1	69,93	377
1471KXXL12BKSS	73141503665432	1	2.814,65	374
1472K-ACTD	7314150399345	1	255,32	374
1472K-ACTSS	7314150399338	1	340,42	374
1472K-ACTW	7314150393152	1	314,89	374
1472K5	7314150349463	1	684,95	371
1472K5BLACK	7314150349500	1	684,95	371
1472K5BLUE	7314150349616	1	684,95	371
1472K5GREY	7314150403813	1	684,95	371
1472K5RED	7314150349562	1	684,95	371
1472K5WHITE	7314150403707	1	684,95	371



# 1472K6



1472K6	7314150349470	1	726,15	371
1472K6BLACK	7314150349531	1	726,15	371
1472K6BLUE	7314150349623	1	726,15	371
1472K6GREY	7314150403820	1	726,15	371
1472K6RED	7314150349579	1	726,15	371
1472K6WHITE	7314150399888	1	726,15	371
1472K7	7314150349487	1	762,20	371
1472K7BLACK	7314150349548	1	762,20	371
1472K7BLUE	7314150349630	1	762,20	371
1472K7GREY	7314150403837	1	762,20	371
1472K7RED	7314150349586	1	762,20	371
1472K7WHITE	7314150403714	1	762,20	371
1472K8	7314150349494	1	803,40	370
1472K8BLACK	7314150349555	1	803,40	370
1472K8BLUE	7314150349647	1	803,40	370
1472K8GREY	7314150404018	1	803,40	370
1472K8RED	7314150349593	1	803,40	370
1472K8WHITE	7314150403721	1	803,40	370
1475K-ACSIDE	7314150419968	1	64,91	377
1475K6	7314150349654	1	813,70	375
1475K6BLACK	7314150349685	1	813,70	375
1475K6BLUE	7314150349760	1	813,70	375
1475K6RED	7314150349715	1	813,70	375
1475K7	7314150349661	1	849,75	375
1475K7BLACK	7314150349692	1	849,75	375
1475K7BLUE	7314150349814	1	849,75	375
1475K7RED	7314150349746	1	849,75	375
1475K8	7314150349678	1	890,95	375
1475K8BLACK	7314150349708	1	890,95	375
1475K8BLUE	7314150349821	1	890,95	375
1475K8RED	7314150349753	1	890,95	375
1475KXL-AC20BK	7314150353903	1	488,06	376
1475KXL12	7314150350223	1	1.478,05	374
1475KXL12BLACK	7314150350230	1	1.478,05	374
1475KXL12RED	7314150402731	1	1.478,05	374
1475KXL6	7314150349968	1	1.318,40	375
1475KXL6BLACK	7314150349999	1	1.318,40	375
1475KXL6BLUE	7314150350162	1	1.318,40	375
1475KXL6C	7314150350193	1	1.431,70	375
1475KXL6CBK-FF5	7314150437467	1	3.786,80	370
1475KXL6CBK-FF6	7314150437474	1	3.014,68	369
1475KXL6CBKBLACK	7314150350209	1	1.658,49	375
1475KXL6RED	7314150350124	1	1.318,40	375
1475KXL7	7314150349975	1	1.369,90	374
1475KXL7BLACK	7314150350070	1	1.369,90	374
1475KXL7BLUE	7314150350179	1	1.369,90	374
1475KXL7RED	7314150350148	1	1.369,90	374
1475KXL7SS	7314150349517	1	4.328,19	514
1475KXL8	7314150349982	1	1.421,40	374
1475KXL8BLACK	7314150350094	1	1.421,40	374
1475KXL8BLUE	7314150350186	1	1.421,40	374
1475KXL8RED	7314150350155	1	1.421,40	374
1475KXL-ACTSS	7314150459896	1	404,31	375
1475KXL-ACTW	7314150465330	1	732,12	375
1475KXL8CWTS	7314150400157	1	4.802,35	374
1476KXL7BK	7314150439935	1	2.950,36	374
1477K-AC10	7314150353163	1	95,69	373
1477K-AC11	7314150369874	1	18,24	424
1477K-AC12	7314150369195	1	182,36	371
1477K-AC13	7314150369218	1	121,58	371
1477K-AC14	7314150369225	1	54,71	372
1477K-AC15	7314150369249	1	145,89	372
1477K-AC16	7314150369256	1	243,15	372
1477K-AC17	7314150369270	1	48,63	372
1477K-AC18	7314150369287	1	55,93	372
1477K-AC19	7314150369676	1	48,63	372
1477K-AC20	7314150369683	1	43,76	372
1477K-AC21	7314150370412	1	91,19	372
1477K-AC22	7314150369706	1	67,17	372
1477K-AC23	7314150369867	1	7,33	424
1477K-AC24	7314150370429	1	334,34	373
1477K-AC25	7314150370436	1	425,53	373
1477K-AC26	7314150414864	1	83,79	373
1477K-AC28	7314150370481	1	18,24	424
1477K-AC29	7314150370498	1	14,58	424
1477K-AC30	7314150469949	1	127,45	373
1477K-AC31	7314150370474	1	207,24	373
1477K-ACTD	7314150383764	1	105,78	373
1477K-ACTP	7314150370450	1	291,79	373
1477K-ACTSS	7314150370467	1	255,32	373
1477K-ACTW	7314150350391	1	1.179,35	370
1477K6	7314150350391	1	1.179,35	370
1477K6BLACK	7314150351091	1	1.179,35	370
1477K6GREY	7314150351138	1	1.179,35	370
1477K6RED	7314150403653	1	1.179,35	370
1477K6WHITE	7314150358137	1	1.179,35	370
1477K7	7314150350407	1	1.246,30	370
1477K7BLACK	7314150351107	1	1.246,30	370
1477K7GREY	7314150351145	1	1.246,30	370
1477K7RED	7314150403660	1	1.246,30	370
1477K7WHITE	7314150358144	1	1.246,30	370
1477K8	7314150350414	1	1.297,80	370
1477K8BLACK	7314150351114	1	1.297,80	370
1477K8GREY	7314150351183	1	1.297,80	370
1477K8RED	7314150403677	1	1.297,80	370
1477K8WHITE	7314150358151	1	1.297,80	370
1477K9	7314150350940	1	1.354,45	370



1477K9BLACK	7314150351121	1	1.354,45	370
1477K9GREY	7314150351190	1	1.354,45	370
1477K9RED	7314150403684	1	1.354,45	370
1477K9WHITE	7314150403691	1	1.354,45	370
148-1	7314150367801	1	43,88	124
148-1/2	7314150367726	1	36,13	124
148-11/16	7314150367757	1	36,13	124
148-13	7314150367559	1	33,55	124
148-13/16	7314150367771	1	43,88	124
148-14	7314150367566	1	33,55	124
148-15	7314150367573	1	33,55	124
148-15/16	7314150367795	1	43,88	124
148-16	7314150367580	1	33,55	124
148-17	7314150367597	1	33,55	124
148-18	7314150367603	1	33,55	124
148-19	7314150367610	1	33,55	124
148-21	7314150367627	1	38,71	124
148-22	7314150367634	1	38,71	124
148-24	7314150367641	1	38,71	124
148-27	7314150367658	1	38,71	124
148-28	7314150367665	1	43,88	124
148-3/4	7314150367764	1	36,13	124
148-30	7314150367672	1	43,88	124
148-32	7314150367689	1	43,88	124
148-34	7314150367696	1	47,76	124
148-36	7314150367702	1	47,76	124
148-41	7314150367719	1	47,76	124
148-5/8	7314150367740	1	36,13	124
148-7/8	7314150367788	1	43,88	124
148-9/16	7314150367733	1	36,13	124
1482K4	7314150415779	1	590,08	371
1482K4BKW	7314150426126	1	737,59	371
1482K4BLACK	7314150415786	1	590,08	371
1482K4BLUE	7314150415793	1	590,08	371
1482K4GREY	7314150415809	1	590,08	371
1482K4RED	7314150415816	1	590,08	371
1482K4W	7314150425174	1	737,59	371
1482K4WHITE	7314150415823	1	590,08	371
1482K5W	7314150431274	1	826,10	371
1483CART	7314150273256	1	216,09	443
1483K2RB	7314150230013	1	340,53	443
1483K3RB	7314150230037	1	413,99	443
1483KHD3RB	7314150230099	1	560,88	443
1483KHD3RB-FF1	7314150233564	1	2.848,40	441
1483KHD3RB-FF2	7314150233571	1	2.776,62	442
1483KHD3RB-FF3	7314150233588	1	2.718,48	442
1483KHD3RB-FF4	7314150233595	1	2.260,23	442
1483KHD3RB-FF5	7314150233601	1	2.716,82	442
1483KHD3RB-FF*	7314150336050	1	2.065,25	442
1483KHD4RB	7314150230105	1	661,03	443
1484THD3RB	7314150265435	1	498,42	443
1485K4	7314150349838	1	650,45	375
1485K4BLACK	7314150349920	1	650,45	375
1485K4BLUE	7314150349944	1	650,45	375
1485K4RED	7314150349937	1	650,45	375
1485KXL4	7314150350247	1	844,97	375
1485KXL4BLACK	7314150350346	1	844,97	375
1485KXL4BLUE	7314150350360	1	844,97	375
1485KXL4RED	7314150350353	1	844,97	375
1487K4	7314150351206	1	1.033,41	370
1487K4BKW	7314150426133	1	1.056,23	370
1487K4BLACK	7314150351213	1	1.033,41	370
1487K4GREY	7314150351237	1	1.033,41	370
1487K4W	7314150425181	1	1.056,23	370
1495CD-AC1	7314150296965	1	82,68	438
1495CD60	7314150296927	1	523,60	436
1495CD60TS1	7314150325627	1	2.020,68	436
1495CD60W	7314150303656	1	1.088,53	435
1495CS-AC1	7314150296910	1	124,01	439
1495CS15	7314150296934	1	709,62	436
1495CS15BL	7314150326860	1	709,62	436
1495CS15TS1	7314150325610	1	2.174,53	435
1495CS18	7314150296941	1	792,29	436
1495CS18BL	7314150326891	1	792,29	436
1495CS18BLHK	7314150407620	1	863,25	436
1495CS18BK	7314150407613	1	863,25	436
1495CS18TS1	7314150325603	1	2.294,73	435
1495FWB120TS	7314150296668	1	419,11	441
1495K6CWB15TS	7314150368440	1	1.570,79	440
1495K6CWB15TW	7314150368501	1	1.818,82	440
1495K6CWB18TS	7314150369355	1	1.639,69	440
1495K6CWB18TW	7314150369393	1	1.956,61	440
1495K7CWB15TS	7314150368464	1	1.667,25	440
1495K7CWB15TW	7314150368518	1	1.915,26	440
1495K7CWB18TS	7314150369362	1	1.736,14	440
1495K7CWB18TW	7314150369409	1	2.053,06	440
1495K8CWB15TS	7314150368471	1	1.715,48	440
1495K8CWB15TW	7314150368525	1	1.715,48	440
1495K8CWB18TS	7314150370061	1	1.784,37	440
1495K8CWB18TW	7314150369416	1	2.101,28	440
1495KWB15TS	7314150338115	1	957,63	440
1495KWB15TW	7314150296613	1	1.164,31	441
1495KWB18TS	7314150338122	1	806,06	440
1495KWB18TW	7314150296620	1	1.371,00	441
1495TP-AC1	7314150297030	1	89,56	438
1495TP-AC10	7314150297207	1	15,85	439

			€	
1495TP-AC11	7314150297214	1	6,62	439
1495TP-AC12	7314150297221	1	8,55	439
1495TP-AC13	7314150297238	1	9,99	439
1495TP-AC2	7314150297122	1	12,40	439
1495TP-AC3	7314150297139	1	16,87	439
1495TP-AC4	7314150297146	1	15,50	439
1495TP-AC5	7314150297153	1	7,57	439
1495TP-AC6	7314150297160	1	7,86	439
1495TP-AC7	7314150297177	1	6,21	440
1495TP-AC8	7314150297184	1	7,16	440
1495TP-AC9	7314150297191	1	17,22	440
1495TP-ACHL20	7314150297047	1	9,36	440
1495TP-ACHL40	7314150297054	1	9,36	440
1495TP-ACHL65	7314150297061	1	10,20	440
1495TP-ACHL90	7314150297078	1	10,89	440
1495TP-ACHU20	7314150297085	1	9,65	440
1495TP-ACHU40	7314150297092	1	9,99	440
1495TP-ACHU65	7314150297108	1	10,89	440
1495TP-ACHU90	7314150297115	1	11,15	440
1495TP-AUTO-M1	7314150438266	1	1.209,65	436
1495TP-AUTO-M2	7314150438273	1	2.124,26	437
1495TP-AUTO-M3	7314150438280	1	1.180,14	437
1495TP-AUTO-M4	7314150438297	1	1.498,78	437
1495TP-AUTO-M5	7314150438303	1	920,51	438
1495TP-AUTO-M6	7314150438310	1	1.239,15	438
1495TP06	7314150296989	1	117,12	438
1495TP09	7314150438624	1	120,28	438
1495TP09-RAIL	7314150465705	1	38,24	438
1495TP12	7314150296996	1	172,24	438
1495TP15	7314150297009	1	206,68	438
1495TP18	7314150297016	1	241,13	438
1495WB-AC1	7314150296576	1	130,90	441
1495WB15-AC1	7314150296590	1	144,67	441
1495WB15TS	7314150296514	1	723,40	441
1495WB15TSBL	7314150326990	1	667,60	441
1495WB15TSBT	7314150407651	1	682,95	441
1495WB15TW	7314150296538	1	1.164,32	441
1495WB18-AC1	7314150296606	1	172,24	441
1495WB18TS	7314150296545	1	806,06	441
1495WB18TSBL	7314150327027	1	806,06	441
1495WB18TSBT	7314150407637	1	969,97	441
1495WB18TW	7314150296569	1	1.329,66	441
1496MB2	7314150273478	1	134,11	448
1496MB3	7314150273485	1	159,67	448
1496MB4	7314150273492	1	191,60	448
1496MB5	7314150273508	1	311,43	448
1497MB08	7314150349869	1	43,61	448
1497MB13	7314150349876	1	60,53	448
1497MB18	7314150349913	1	66,56	449
1497MBF350	7314150321391	1	59,64	448
1497MBF550	7314150321407	1	71,87	448
1497MBF750	7314150321414	1	80,86	447
1497MBW	7314150330164	1	590,59	447
14A-32	7314150368228	1	105,82	125
14A-9	7314150368211	1	77,44	125
14F-1/2	7314150366200	1	43,88	122
14F-3/4	7314150366217	1	73,56	122
14P-1/2	7314150366064	1	103,25	122
14Q-1/2	7314150366026	1	113,57	122
14R-1/2	7314150365920	1	72,28	121
14R-3/4	7314150365937	1	116,14	121
14T-1/2	7314150366125	1	92,92	122
14T-3/4	7314150366132	1	167,77	122
14W	7314150357031	1	43,88	125
1519 D	7314150032747	3	125,63	240
1519-9	7314150026074	1	62,61	240
1520 D	7311518278922	5	45,16	237
1520 G	7311518266516	5	40,04	237
1520 G IP	7314150437740	5	39,93	237
1535	7314150214808	1	9,43	533
1537	7314150214822	1	14,80	533
1544	7311518276560	1	17,54	533
1546	7314150214792	1	10,39	533
1547	7311518276577	20	14,30	533
158-N	7311518277239	12	38,25	246
158-NB	7311518277246	12	39,80	247
1610	7314150404186	1	81,06	270
1610-NUT	7314150409594	1	12,86	270
1620	7314150404193	1	110,27	270
1620-NUT	7314150409754	1	15,05	270
166-6-16-2.5-12	7311518021979	12	4,39	28
166-6-16-2.5-2	7311518209698	5	9,00	28
167-1	7314150419067	1	117,12	126
167-1.1/16	7314150419074	1	117,12	126
167-1.1/4	7314150419104	1	117,12	126
167-1.1/8	7314150419081	1	117,12	126
167-1.3/16	7314150419098	1	117,12	126
167-1/2	7314150418930	1	59,46	126
167-10	7314150418657	1	54,09	126
167-11	7314150418664	1	54,09	126
167-11/16	7314150419364	1	57,88	126
167-12	7314150418671	1	55,89	126
167-13	7314150418688	1	55,89	126
167-13/16	7314150419036	1	77,54	126
167-14	7314150418695	1	55,89	126
167-15	7314150418701	1	55,89	126

\* Hasta agotar existencias

			€	
167-15/16	7314150419050	1	96,90	126
167-16	7314150418718	1	57,30	126
167-17	7314150418725	1	57,30	126
167-18	7314150418732	1	61,73	126
167-19	7314150418749	1	67,07	126
167-20	7314150418763	1	67,32	126
167-21	7314150418770	1	72,87	126
167-22	7314150418787	1	91,12	126
167-23	7314150418794	1	91,12	126
167-24	7314150418800	1	91,12	126
167-25	7314150418817	1	110,12	126
167-26	7314150418824	1	110,12	126
167-27	7314150418831	1	110,12	126
167-28	7314150418848	1	110,12	126
167-3/4	7314150419029	1	67,96	126
167-3/8	7314150418909	1	57,54	126
167-30	7314150418855	1	110,12	126
167-32	7314150418862	1	110,12	126
167-36	7314150418886	1	136,53	126
167-5/16	7314150418893	1	57,54	126
167-5/8	7314150419012	1	60,92	126
167-7	7314150418619	1	54,09	126
167-7/16	7314150418916	1	59,46	126
167-7/8	7314150419043	1	96,90	126
167-8	7314150418626	1	54,09	126
167-8-21-3.2-12	7311518021986	12	7,65	28
167-9	7314150418640	1	54,09	126
167-9/16	7314150419005	1	59,46	126
168-1	7314150419562	1	123,00	127
168-1.1/16	7314150419579	1	123,00	127
168-1.3/16	7314150419586	1	144,30	127
168-1/2	7314150419487	1	62,37	127
168-10	7314150419272	1	56,76	126
168-11	7314150419289	1	56,76	126
168-11/16	7314150419517	1	57,88	127
168-12	7314150419296	1	58,66	127
168-13	7314150419302	1	58,66	127
168-13/16	7314150419531	1	75,21	127
168-14	7314150419319	1	58,66	127
168-15	7314150419326	1	58,66	127
168-15/16	7314150419555	1	101,73	127
168-16	7314150419333	1	60,15	127
168-17	7314150419340	1	60,15	127
168-18	7314150419357	1	64,75	127
168-19	7314150419371	1	67,07	127
168-20	7314150419388	1	70,70	127
168-21	7314150419395	1	76,46	127
168-22	7314150419401	1	95,63	127
168-23	7314150419418	1	95,63	127
168-24	7314150419425	1	95,63	127
168-26	7314150419432	1	115,67	127
168-27	7314150419449	1	115,67	127
168-3/4	7314150419524	1	75,21	127
168-3/8	7314150419463	1	60,40	127
168-5/16	7314150419456	1	60,40	127
168-5/8	7314150419500	1	63,97	127
168-6-3.2-1P	7311518152338	12	1,80	28
168-6-3.2-3P	7311518152413	12	5,19	28
168-6-3.5-1P	7311518152345	12	1,80	28
168-6-3.5-3P	7311518152420	12	5,19	28
168-7	7314150419241	1	56,76	126
168-7/16	7314150419470	1	60,40	127
168-7/8	7314150419548	1	101,73	127
168-8	7314150419258	1	56,76	126
168-8-4.0-1P	7311518152352	12	1,80	28
168-8-4.0-3P	7311518152437	12	5,19	28
168-8-4.0-6	7311518217419	6	1,76	29
168-8-4.5-1P	7311518152369	12	1,80	28
168-8-4.5-3P	7311518152444	12	5,19	28
168-8-4.5-6	7311518217426	6	1,76	29
168-8-4.8-1P	7311518152376	12	1,80	28
168-8-4.8-3P	7311518152451	12	5,19	28
168-8-4.8-6	7311518217433	6	1,76	29
168-8-5.2-1P	7311518152383	12	1,80	28
168-8-5.2-3P	7311518152468	12	5,19	28
168-8-5.2-6	7311518217440	6	1,77	29
168-8-5.5-1P	7311518152390	12	1,80	28
168-8-5.5-3P	7311518152475	12	5,19	28
168-8-5.5-6	7311518217457	6	1,76	29
168-8-6.3-1P	7311518152406	12	2,07	28
168-8-6.3-3P	7311518152482	12	5,19	28
168-9	7314150419265	1	56,76	126
168-9/16	7314150419494	1	62,37	127
168-COMBI-4.0	7311518209667	10	15,47	29
168-COMBI-4.0-6922	7311518209612	10	29,98	29
168-COMBI-4.5	7314150272860	10	15,47	29
168-COMBI-4.8	7311518209674	10	15,47	29
168-COMBI-4.8-6920	7311518209643	10	30,80	29
168-COMBI-5.5	7311518209681	10	15,47	29
168-COMBI-5.5-6924	7311518209650	10	30,80	29
169-10	7314150419630	1	59,63	127
169-11	7314150419647	1	59,63	127
169-12	7314150419654	1	61,68	127
169-13	7314150419661	1	61,68	127
169-14	7314150419678	1	61,68	127
169-15	7314150419715	1	61,68	127







169-16	7314150419722	1	63,09	127
169-17	7314150419739	1	63,09	127
169-18	7314150419746	1	68,04	127
169-19	7314150419753	1	70,45	127
169-20	7314150419760	1	74,16	127
169-21	7314150419777	1	80,33	127
169-22	7314150419784	1	100,49	127
169-23	7314150419791	1	100,49	127
169-24	7314150419807	1	100,49	127
169-27	7314150419814	1	121,35	127
169-7	7314150419609	1	59,63	127
169-8	7314150419616	1	59,63	127
169-9	7314150419623	1	59,63	127
16F-1/2	7314150418565	1	81,93	125
16F-1/4	7314150418541	1	81,93	125
16F-3/8	7314150418558	1	81,93	125
16R-1/2	7314150418602	1	104,04	125
16R-1/4	7314150418589	1	104,04	125
16R-3/8	7314150418596	1	104,04	125
1931M-10	7314151049256	5	11,67	51
1931M-11	7314151049263	5	12,54	51
1931M-12	7314151049270	5	12,54	51
1931M-13	7314151049287	5	12,54	51
1931M-14	7314151049294	5	13,38	51
1931M-17	7314151049324	5	17,71	51
1931M-4	7314151049171	5	9,94	51
1931M-4.5	7314151049188	5	9,94	51
1931M-5	7314151049195	5	9,94	51
1931M-5.5	7314151049201	5	9,94	51
1931M-6	7314151049218	5	9,94	51
1931M-7	7314151049225	5	9,94	51
1931M-8	7314151049232	5	10,36	51
1931M-9	7314151049249	5	11,23	51
1931M/10T	7314151049409	1	111,86	52
1931Z-1/2	7314151049775	5	13,38	51
1931Z-1/4	7314151049713	5	10,36	51
1931Z-1/8	7314150371563	5	15,99	51
1931Z-11/32	7314151049744	5	12,10	51
1931Z-11/32-3/8	7314150371624	5	19,00	51
1931Z-13/64	7314151049683	5	10,36	51
1931Z-15/64-1/4	7314150371570	5	17,87	51
1931Z-3/16	7314151049676	5	10,36	51
1931Z-3/8	7314151049751	5	12,54	51
1931Z-5/16	7314151049737	5	11,67	51
1931Z-5/32	7314151049669	5	10,36	51
1931Z-5/8	7314151049799	5	16,40	51
1931Z-7/16	7314151049768	5	13,38	51
1931Z-7/32	7314151049690	5	10,36	51
1931Z-9/16	7314151049782	5	14,27	51
1931Z-9/32	7314151049720	5	10,79	51
1931Z-9/32-5/16	7314150371600	5	16,86	51
1931Z/12T	7314150107674	1	144,61	52
1933M/6T	7314151821654	1	60,33	52
1936M-10-11	7314151051402	25	8,40	60
1936M-10-13	7314151344146	25	9,18	60
1936M-12-13	7314151051419	25	9,18	60
1936M-13-17	7314151830144	20	10,68	60
1936M-14-15	7314151051426	20	9,69	60
1936M-14-17	7314151051129	15	10,52	60
1936M-16-17	7314151051433	15	10,52	60
1936M-17-19	7314151051136	10	12,55	60
1936M-18-19	7314151051440	10	12,55	60
1936M-19-22	7314151051150	8	13,82	60
1936M-20-22	7314151830151	8	13,96	60
1936M-21-23	7314151830168	8	15,99	60
1936M-22-24	7314151830175	5	16,90	60
1936M-24-26	7314151830182	5	17,78	60
1936M-24-27	7314151051181	5	17,78	60
1936M-25-28	7314151830199	5	19,59	60
1936M-30-32	7314151051501	1	23,02	60
1936M-30-34	7314151838577	4	35,40	60
1936M-36-41	7314151830205	4	35,67	60
1936M-46-50	7314151830212	2	71,03	60
1936M-6-7	7314151051389	50	6,19	60
1936M-8-10	7314151830137	30	8,40	60
1936M-8-9	7314151051396	5	7,17	60
1936M/12	7314151830250	1	190,91	60
1936M/7	7314151830243	1	108,45	60
1943M-11-13*	7314151052829	1	28,83	55
1943M-13-15*	7314151804732	1	30,71	55
1943M-13-17*	7314151804749	1	32,42	55
1943M-14-17*	7314151052843	1	33,05	55
1943M-15-17*	7314151052850	1	33,38	55
1943M-19-22*	7314151052867	1	35,37	55
1943Z-11/16-13/16*	7314150355174	1	37,00	55
1943Z-5/16-3/8*	7314150355136	1	31,44	55
1943Z-5/8-3/4*	7314150355167	1	32,96	55
1943Z-7/16-1/2*	7314150355143	1	31,44	55
1943Z-9/16-5/8*	7314150355150	1	32,96	55
1945W12	7314150352289	6	58,10	312
1945W14	7314150352265	8	37,99	312
1945W38	7314150352272	6	45,80	312
1949M-10-11	7314151055394	1	23,91	56
1949M-10-12	7314151055400	1	24,81	56
1949M-12-13	7314151055417	1	25,55	56
1949M-12-14	7314151055424	1	26,81	56



1949M-14-15	7314151304546	1	26,81	56
1949M-14-17	7314151055448	1	26,81	56
1949M-17-19	7314151055455	1	36,64	56
1949M-19-22	7314151055462	1	36,64	56
1949M-22-24	7314151304553	1	41,93	56
1949M-24-27	7314151055479	1	53,00	56
1949M-30-32	7314151304577	1	65,61	56
1949M-8-9	7314151304539	1	23,91	56
1949Z-1-1.1/8	7314151055547	1	58,36	56
1949Z-1/2-9/16	7314151055509	1	28,92	56
1949Z-3/4-7/8	7314151055530	1	34,97	56
1949Z-3/8-7/16	7314151055486	1	25,76	56
1949Z-5/8-3/4	7314151055523	1	32,40	56
1950MZ-3/8	7314150130207	1	79,33	57
1952M-10	7314151057213	10	10,51	45
1952M-11	7314151057220	10	11,27	45
1952M-12	7314151057237	10	11,91	45
1952M-13	7314151057244	10	12,91	45
1952M-14	7314151057251	10	13,02	45
1952M-15	7314151057268	10	15,41	45
1952M-16	7314151057275	10	16,67	45
1952M-17	7314151057282	10	17,22	45
1952M-18	7314151057299	10	19,27	45
1952M-19	7314151057305	10	20,20	45
1952M-20	7314151057312	10	21,39	45
1952M-21	7314151057329	10	22,23	45
1952M-22	7314151057336	5	24,93	45
1952M-23	7314151057343	5	26,92	45
1952M-24	7314151057350	5	28,14	45
1952M-25	7314151057367	5	30,03	45
1952M-26	7314151057374	5	30,32	45
1952M-27	7314151057381	5	32,33	45
1952M-28	7314151057398	1	36,86	45
1952M-29	7314151325763	1	39,35	45
1952M-30	7314151057404	1	41,31	45
1952M-32	7314151057411	1	43,20	45
1952M-34	7314151838553	1	55,99	45
1952M-36	7314151057428	1	73,40	45
1952M-41	7314151057435	1	91,25	45
1952M-46	7314151840105	1	146,81	45
1952M-50	7314151840112	1	186,62	45
1952M-55	7314151840129	1	238,31	45
1952M-6	7314151057176	10	9,46	45
1952M-60	7314151840136	1	362,92	45
1952M-65	7314150135226	1	463,81	45
1952M-7	7314151057183	10	9,46	45
1952M-70	7314150135301	1	500,80	45
1952M-75	7314150135325	1	567,50	45
1952M-8	7314151057190	10	9,34	45
1952M-80	7314150135509	1	680,41	45
1952M-9	7314151057206	10	10,51	45
1952M/10	7314151057688	1	132,30	46
1952M/14T	7314151057695	1	295,37	46
1952M/17T	7314151057473	1	266,45	46
1952M/26T	7314151057701	1	574,10	46
1952M/7T	7314151806637	1	112,40	46
1952M/SH12	7314153013330	1	182,02	46
1952M/SH6	7314153013286	1	81,81	46
1952Z-1	7314151057602	1	31,11	45
1952Z-1.1/16	7314151057619	1	34,20	45
1952Z-1.1/2	7314151057756	1	97,38	45
1952Z-1.1/4	7314151057633	1	46,37	45
1952Z-1.1/8	7314151057626	1	40,38	45
1952Z-1.3/8	7314151057732	1	90,93	45
1952Z-1.5/16	7314151057718	1	50,07	45
1952Z-1.5/8	7314151057763	1	116,72	45
1952Z-1.7/16	7314151057749	1	96,41	45
1952Z-1/2	7314151057527	5	20,04	45
1952Z-1/4	7314151057480	5	9,97	45
1952Z-11/16	7314151057558	5	20,00	45
1952Z-11/32	7314150111046	5	10,76	45
1952Z-13/16	7314151057572	5	23,39	45
1952Z-15/16	7314151057596	5	29,90	45
1952Z-3/4	7314151057565	5	21,87	45
1952Z-3/8	7314151057503	5	11,31	45
1952Z-5/16	7314151057497	5	10,12	45
1952Z-5/8	7314151057541	5	16,97	45
1952Z-7/16	7314151057510	5	12,28	45
1952Z-7/8	7314151057589	5	28,07	45
1952Z-9/16	7314151057534	5	14,95	45
1952Z/11T	7314151057725	1	185,30	47
1976TORX-T10	7314150123438	5	7,94	234
1976TORX-T15	7314150123452	5	8,17	234
1976TORX-T20	7314150123469	5	8,26	234
1976TORX-T25	7314150123476	5	8,37	234
1976TORX-T27	7314150123490	5	9,28	234
1976TORX-T30	7314150123506	5	9,73	234
1976TORX-T40	7314150123513	5	10,39	234
1976TORX-T6	7314150122240	5	7,85	234
1976TORX-T7	7314150123384	5	7,85	234
1976TORX-T8	7314150123391	5	7,85	234
1976TORX-T9	7314150123414	5	7,61	234
1976TORX/5T	7314150126927	1	42,46	234
1986TORX-T10	7314150123537	5	9,00	233
1986TORX-T15	7314150123544	5	9,23	233
1986TORX-T20	7314150123551	5	9,35	233



1986TORX-T25	7314150123568	5	9,52	233
1986TORX-T27	7314150123575	5	9,59	233
1986TORX-T30	7314150123582	5	9,98	233
1986TORX-T40	7314150123599	5	10,65	233
1986TORX-T9	7314150122233	5	8,69	233
1986TORX/7T	7314150123735	1	70,86	233
1995LM-1.5	7314150122172	10	0,72	230
1995LM-10	7314150123254	10	5,01	230
1995LM-12	7314150123261	10	7,51	230
1995LM-14	7314150123278	10	9,27	230
1995LM-2	7314150122189	10	0,53	230
1995LM-2.5	7314150123162	10	0,63	230
1995LM-3	7314150123179	10	0,82	230
1995LM-4	7314150123186	10	0,95	230
1995LM-5	7314150123209	10	1,39	230
1995LM-6	7314150123216	10	2,08	230
1995LM-7	7314150123223	10	2,74	230
1995LM-8	7314150123230	10	3,56	230
1995LM-9	7314150123247	10	4,45	230
1995M-0.9	7314150216291	10	0,82	229
1995M-1.5	7314150122158	10	0,52	229
1995M-10	7314150122912	10	2,44	229
1995M-12	7314150122943	10	3,94	229
1995M-14	7314150122967	10	5,56	229
1995M-17	7314150122974	10	8,92	229
1995M-19	7314150122981	10	13,44	229
1995M-2	7314150122745	10	0,57	229
1995M-2.5	7314150122752	10	0,59	229
1995M-22	7314150122998	10	20,03	229
1995M-3	7314150122769	10	0,78	229
1995M-4	7314150122776	10	0,89	229
1995M-5	7314150122790	10	0,84	229
1995M-6	7314150122813	10	1,06	229
1995M-7	7314150122837	10	1,51	229
1995M-8	7314150122851	10	1,90	229
1995M-9	7314150122875	10	2,18	229
1995M/10T	7314150123643	1	17,21	229
1995M/11T	7314150123650	1	21,17	229
1995M/15T	7314150123667	1	72,53	229
1995M/6T	7314150123629	1	5,76	229
1995M/8T	7314150123636	1	10,65	229
1995TORX-T10	7314150123308	5	5,22	232
1995TORX-T15	7314150123322	5	5,33	232
1995TORX-T20	7314150123339	5	5,54	232
1995TORX-T25	7314150123346	5	5,56	232
1995TORX-T27	7314150123353	5	5,69	232
1995TORX-T30	7314150123360	5	5,78	232
1995TORX-T40	7314150123377	5	6,06	232
1995TORX-T45	7314150123407	5	6,31	232
1995TORX-T50	7314150123421	5	7,17	232
1995TORX-T55	7314150216963	5	10,19	232
1995TORX-T6	7314150122196	5	6,45	232
1995TORX-T60	7314150216970	5	12,36	232
1995TORX-T7	7314150123285	5	6,45	232
1995TORX-T8	7314150123292	5	6,45	232
1995TORX-T9	7314150122219	5	6,11	232
1995TORX/11T	7314150123742	1	69,34	232
1995TORX/13T	7314150123759	1	83,25	232
1995TORX/4T	7314150123674	1	25,38	232
1995TORX/7T	7314150123711	1	41,39	232
1995Z-1/16	7314150122165	10	0,56	229
1995Z-1/2	7314150123117	10	5,58	229
1995Z-1/4	7314150123070	10	1,23	229
1995Z-1/8	7314150123025	10	0,62	229
1995Z-3/16	7314150123056	10	0,87	229
1995Z-3/32	7314150123018	10	0,48	229
1995Z-3/4	7314150123155	10	17,02	229
1995Z-3/8	7314150123094	10	2,98	229
1995Z-5/16	7314150123087	10	2,06	229
1995Z-5/32	7314150123049	10	0,76	229
1995Z-5/64	7314150123001	10	0,45	229
1995Z-5/8	7314150123131	10	10,08	229
1995Z-7/16	7314150123100	10	4,56	229
1995Z-7/32	7314150123063	10	1,00	229
1995Z/10T	7314150215980	1	14,20	230
1995Z/12T	7314150215997	1	23,12	230
1996M-1.5	7314150122202	10	1,67	231
1996M-10	7314150122721	10	9,67	231
1996M-12	7314150122738	5	10,34	231
1996M-2	7314150122653	10	1,85	231
1996M-2.5	7314150122660	10	1,68	231
1996M-3	7314150122677	10	1,73	231
1996M-4	7314150122684	10	2,06	231
1996M-5	7314150122691	10	3,37	231
1996M-6	7314150122707	10	3,83	231
1996M-8	7314150122714	10	5,40	231
1996TORX-T10	7314150122783	5	9,15	233
1996TORX-T15	7314150122806	5	9,45	233
1996TORX-T20	7314150122820	5	9,59	233
1996TORX-T25	7314150122844	5	9,74	233
1996TORX-T27	7314150122868	5	9,81	233
1996TORX-T30	7314150122882	5	10,27	233
1996TORX-T40	7314150122899	5	10,95	233
1996TORX-T45	7314150122905	5	11,47	233
1996TORX-T50	7314150122929	5	13,00	233
1996TORX-T9	7314150122226	5	7,93	233

\* Hasta agotar existencias



1996TORX/5T	7314150123698	1	48,30	233
1998M-1.5	7314150185719	10	0,62	228
1998M-10	7314150185801	10	3,03	228
1998M-12	7314150185818	5	4,45	228
1998M-14	7314150185825	1	6,02	228
1998M-17	7314150185832	1	9,52	228
1998M-19	7314150185849	1	14,28	228
1998M-2	7314150185726	10	0,64	228
1998M-2.5	7314150185733	10	0,68	228
1998M-22	7314150185856	1	21,17	228
1998M-3	7314150185740	10	0,89	228
1998M-4	7314150185757	10	0,79	228
1998M-5	7314150185764	10	1,10	228
1998M-6	7314150185863	10	1,35	228
1998M-7	7314150185771	10	1,90	228
1998M-8	7314150185788	10	2,17	228
1998M-9	7314150185795	5	2,90	228
1998M/10T	7314150186228	1	18,43	228
1998M/11T	7314150186235	1	23,88	228
1998M/15T	7314150186242	1	78,12	228
1998M/6T	7314150186204	1	7,51	228
1998M/8T	7314150186211	1	12,07	228
1999M/7H*	73141501801076	1	33,75	228
1999MV-10	7314150121496	3	20,57	490
1999MV-12	7314150121502	3	23,12	490
1999MV-3	7314150121427	5	15,86	490
1999MV-4	7314150121434	5	16,43	490
1999MV-5	7314150121441	5	16,26	490
1999MV-6	7314150121458	5	16,58	490
1999MV-7	7314150121465	5	17,37	490
1999MV-8	7314150121472	5	18,34	490
1999MV-9	7314150121489	5	18,97	490
1RM-10	7314153000576	60	26,52	47
1RM-11	7314153000583	60	28,15	47
1RM-12	7314153000590	60	30,23	47
1RM-13	7314153000606	60	31,31	47
1RM-14	7314153000613	30	32,67	47
1RM-15	7314153000620	30	33,59	47
1RM-16	7314153000637	30	36,62	47
1RM-17	7314153000644	30	36,94	47
1RM-18	7314153000651	30	39,96	47
1RM-19	7314153000668	30	40,30	47
1RM-21	7314150214495	30	43,04	47
1RM-22	73141530005915	30	43,41	47
1RM-24	73141530005922	30	46,91	47
1RM-27	7314153014177	20	54,75	47
1RM-30	7314153014184	20	66,23	47
1RM-32	7314153014191	20	72,06	47
1RM-6	7314153014146	60	23,23	47
1RM-7	7314153014153	60	23,23	47
1RM-8	7314153000552	60	24,53	47
1RM-9	7314153000569	60	24,84	47
1RM/S5	7314150225514	10	159,88	48
1RM/SH12	7314150219780	10	399,21	48
1RM/SH6	7314150219773	20	188,96	48
1RM/SH8	7314150223015	1	270,43	48
1RMA-10-1/4-BIT	7314153014634	1	7,86	50
1RMA-10-1/4-SQ	7314153014603	1	10,01	50
1RMA-13-10-BIT	7314150223008	1	12,39	50
1RMA-13-3/8-SQ	7314153014610	1	10,53	50
1RMA-13-5/16-BIT	7314153014641	1	8,62	50
1RMA-19-1/2-SQ	7314153014627	1	11,38	50
1RMA-19-1/4-SQ	7314150190638	100	11,13	50
1RMA/S4	7314153014658	30	39,45	50
1RMA/S8	7314153014665	1	143,94	48
1RZ-1/2	7314153014245	60	34,28	47
1RZ-1/4	7314150153725	50	26,68	47
1RZ-11/16	7314153014269	30	41,93	47
1RZ-11/32	7314150358915	60	23,23	47
1RZ-15/16	7314150358939	30	60,26	47
1RZ-3/4	7314153014276	30	45,55	47
1RZ-3/8	7314153014214	60	27,89	47
1RZ-5/16	7314153014207	60	26,96	47
1RZ-5/8	7314153014252	30	39,42	47
1RZ-7/16	7314153014221	60	30,78	47
1RZ-7/8	7314150358922	30	50,09	47
1RZ-9/16	7314153014238	30	35,62	47
1RZ/SH8	7314150223022	1	291,44	48
1Z-1	7314150375189	10	17,33	43
1Z-1/2	7314150375103	10	6,49	43
1Z-11/16	7314150375134	10	8,04	43
1Z-11/32*	7314150375073	10	5,49	43
1Z-13/16	7314150375158	10	10,74	43
1Z-15/16	7314150375172	5	17,09	43
1Z-3/16	7314150375028	20	7,68	43
1Z-3/4	7314150375141	10	9,28	43
1Z-3/8	7314150375080	10	5,49	43
1Z-5/16	7314150375066	10	4,78	43
1Z-5/8	7314150375127	10	7,77	43
1Z-7/16	7314150375097	10	5,87	43
1Z-7/32*	7314150375035	20	7,68	43
1Z-7/8	7314150375165	10	10,74	43
1Z-9/16	7314150375110	10	6,87	43
1Z-9/32	7314150375059	10	7,40	43
2-21-51	7315962500011	5	16,84	619
2-300-14-0-0	7311518044138	10	7,96	33







2-300-14-2-0	7311518044145	10	7,96	33
2-300-14-4-0	7311518108786	10	8,39	33
2-300-14-D-1P	7311518189105	10	55,51	36
2-300-16-0-0	7311518020491	10	8,64	33
2-300-16-1-0	7311518020507	10	8,64	33
2-300-16-2-0	7311518020514	10	8,64	33
2-300-16-4-0	7311518020521	10	9,17	33
2-300-16-D-1P	7311518189129	10	74,48	36
2-300-18-0-0	7311518190545	10	10,05	33
2-300-18-2-0	7311518190552	10	10,05	33
2-301-14-0-0	7311518190569	10	9,17	33
2-301-14-2-0	7311518108748	10	9,17	33
2-301-14-D-1P	7311518189136	1	55,51	36
2-301-16-0-0	7311518108755	10	10,05	33
2-301-16-1-0	7311518020538	10	10,05	33
2-301-16-2-0	7311518020545	10	10,05	33
2-302-14-0-0	7311518044152	10	9,17	34
2-302-14-2-0	7311518044169	10	9,17	34
2-302-14-4-0	7311518108793	10	9,56	34
2-302-14-D-1P	7311518189150	10	61,08	36
2-302-16-0-0	7311518108762	10	10,05	34
2-302-16-1-0	7311518020552	10	10,05	34
2-302-16-2-0	7311518020569	10	10,05	34
2-302-16-4-0	7311518108809	10	10,44	34
2-302-16-D-1P	7311518189167	10	81,68	36
2-302-18-0-0	7311518190613	10	11,52	34
2-302-18-2-0	7311518190620	10	11,52	34
2-303-14-2-0	7311518044176	10	9,17	34
2-303-14-D-1P	7311518189174	10	55,51	36
2-303-16-0-0	7311518108779	10	10,05	34
2-303-16-1-0	7311518020576	10	10,05	34
2-303-16-2-0	7311518020583	10	10,05	34
2-303-16-4-0	7311518108830	10	10,44	34
2-303-16-D-1P	7311518189198	1	74,48	36
2-303-18-0-0	7311518190644	10	11,52	34
2-303-18-2-0	7311518190668	10	11,52	34
2-304-14-0-0	7311518044183	10	10,44	33
2-304-14-2-0	7311518044190	10	10,44	33
2-304-14-4-0	7311518108878	10	11,26	33
2-304-14-D-1P	7311518189204	10	61,08	36
2-304-16-0-0	7311518020590	10	11,52	33
2-304-16-1-0	7311518020606	10	11,52	33
2-304-16-2-0	7311518020613	10	11,52	33
2-304-16-4-0	7311518020620	10	12,16	33
2-304-16-D-1P	7311518189211	10	81,68	36
2-304-18-0-0	7311518190712	10	13,31	33
2-304-18-2-0	7311518190736	10	13,31	33
2-305-16-1-0	7311518020637	10	11,52	34
2-305-16-2-0	7311518108908	10	11,52	34
2-306-14-D-1P	7311518189228	1	61,08	36
2-306-16-1-0	7311518020644	10	11,52	34
2-306-16-2-0	7311518108854	10	11,52	34
2-307-14-0-0	7311518044206	10	7,96	34
2-307-14-2-0	7311518044213	10	7,96	34
2-307-14-4-0	7311518108885	10	8,39	34
2-307-14-D-1P	7311518189235	10	55,51	36
2-307-16-0-0	7311518020651	10	8,64	34
2-307-16-1-0	7311518020668	10	8,64	34
2-307-16-2-0	7311518020675	10	8,64	34
2-307-16-4-0	7311518020682	10	9,17	34
2-307-16-D-1P	7311518189242	10	74,48	36
2-307-18-0-0	7311518190965	10	10,05	34
2-307-18-2-0	7311518190972	10	10,05	34
2-308-14-2-0	7311518044220	10	10,44	34
2-308-14-D-1P	7311518189259	1	61,08	36
2-308-16-0-0	7311518108861	10	11,52	34
2-308-16-1-0	7311518020699	10	11,52	34
2-308-16-2-0	7311518020705	10	11,52	34
2-309-16-2-0	7311518108946	10	10,05	34
2-309-16-4-0	7311518191054	10	10,44	34
2-313-16-0-0	7311518191177	10	11,52	34
2-470-14-0-0	7311518191191	10	49,36	34
2-470-14-2-0	7311518109080	10	48,15	35
2-470-14-4-0	7311518191207	10	52,56	35
2-470-16-1-0	7311518010942	10	50,69	35
2-470-16-2-0	7311518109097	10	52,27	35
2-471-16-1-0	7311518010959	5	86,03	35
2-472-14-0-0	7311518191214	5	93,94	35
2-472-14-2-0	7311518109103	5	93,94	36
2-472-16-0-0	7311518191238	5	101,37	36
2-472-16-1-0	7311518010966	5	101,37	36
2-472-16-2-0	7311518108922	5	101,37	36
204030150	8413345400855	12	16,05	538
204030160	8413345400862	12	17,12	538
204030180	8413345400879	12	18,04	538
204530140	8413345097918	12	19,14	538
204550130	8413345097956	6	29,44	538
2045A3000	8413345097932	12	20,86	539
2047-0-8-4	7314151060459	5	6,56	234
2047-1-5-5	7314151060473	5	8,00	234
2047-1-2-8	7314151060480	5	10,25	234
2047-1-6-10	7314151060497	1	14,07	234
2047-2-12	7314151060503	1	20,51	234
2047PR-1-2	7314151060558	5	8,24	234
2047PR-3-4	7314151060565	5	13,62	234
2047PZ-1-2	7314150216390	5	8,44	234



2058/S26	7314151849276	30	38,89	174
2058/S26-2	7314151849283	1	38,90	175
2058/S26AF	7314150516308	1	24,95	175
208	7311518017545	5	17,03	544
209027040	8413345400947	12	16,69	538
209227060	8413345400961	12	16,20	538
209228100	8413345099233	12	17,12	538
209250100	8413345099585	6	29,00	538
210	7315965100379	10	32,75	544
2100PD-150	7314150205691	5	32,30	238
2101D-125	7314150106387	5	20,67	236
2101D-125IP	7314150106431	5	19,03	236
2101D-140	7314150106394	5	20,67	236
2101D-140IP	7314150106325	5	19,03	236
2101D-160	7314150106400	5	21,02	236
2101D-160IP	7314150106318	5	19,36	236
2101D-180	7314150106417	5	22,87	236
2101D-180IP	7314150106448	5	21,22	236
2101G-125	7314150106462	5	24,72	236
2101G-125IP	7314150106516	5	23,09	236
2101G-125IPD	7314150335039	5	23,09	236
2101G-140	7314150106479	5	25,15	236
2101G-140IP	7314150106288	5	23,51	236
2101G-140IPD	7314150335053	5	23,51	236
2101G-160	7314150106486	5	25,67	236
2101G-160IP	7314150106295	5	24,07	236
2101G-160IPD	7314150335060	5	24,07	236
2101G-180	7314150106493	5	27,46	236
2101G-180IP	7314150106523	5	25,79	236
2101G-180IPD	7314150335077	5	25,79	236
2101GC-125IP	7314150106547	5	23,46	236
2101GC-140IP	7314150106554	5	23,59	236
2101GC-160IP	7314150106561	5	24,57	236
2101GC-180IP	7314150106578	5	26,77	236
2101PG-160	7314150113972	5	55,61	236
2101S-140	7314150106592	3	26,89	486
2101S-160	7314150106608	3	28,98	486
2101S-180	7314150106615	3	32,41	486
2101S-200	7314150106622	3	39,96	487
211035180	8413345000147	5	8,26	539
211042210	8413345000154	5	10,80	539
212027180	8413345000178	5	6,39	539
212033220	8413345129435	8	6,92	539
212202500	8413345110266	10	21,60	539
212302900	8413345110280	10	16,07	540
212502150	8413345110303	10	12,96	540
212602150	8413345110327	10	15,19	540
212602800	8413345129404	1	19,91	540
212704350	8413345122184	6	42,91	539
213026140	8413345000185	5	5,29	539
2145020D0	8413345097994	1	13,41	539
2145020L0	8413345098045	1	13,41	539
2145025C0	8413345098083	1	14,00	539
2145025D0	8413345098007	1	13,55	539
2145025L0	8413345098052	1	13,55	539
2145030D0	8413345098014	1	13,73	539
2145030L0	8413345098069	1	13,73	539
2145035D0	8413345098021	1	14,00	539
2145035L0	8413345098076	1	14,00	539
2145039C0	8413345098090	1	14,35	539
2145PD-150	7314150114009	5	52,06	239
215-150	7311518017576	1	7,23	546
215000030	8413345131971	12	4,66	537
215000040	8413345131988	12	4,83	537
215000050	8413345131995	12	5,02	537
215000060	8412243557944	12	5,15	537
215000070	8413345132008	12	5,55	537
215000080	8413345132015	12	5,87	537
215000090	8413345132022	12	6,32	537
215000100	8413345132039	12	7,10	537
215000120	8413345132046	12	8,70	537
215500300	7314150220120	12	7,64	537
215500400	8413345122627	12	8,31	537
215500500	8413345122641	12	8,53	537
215500600	8413345122665	12	8,69	537
215500700	8413345122689	12	8,90	537
215500800	8413345122702	12	9,31	537
215500900	8413345137478	12	9,51	537
215501000	8413345122726	12	9,92	537
216-150-R	7311518017583	1	7,23	546
216-300-R	7311518017798	1	10,65	546
216000300	8413345403658	12	3,96	537
216000400	8413345403665	12	4,07	537
216000500	8413345403672	12	4,27	537
216000600	8413345403689	12	4,39	537
216000700	8413345403696	12	4,73	537
216000800	8413345403702	12	4,96	537
216000900	8413345403719	12	5,24	537
216001000	8413345403726	12	6,02	537
216001200	8413345403740	12	7,05	537
216100040	8413345132053	12	8,60	537
216100060	8413345132091	12	10,08	537
216100080	8413345132060	12	11,33	537
216100100	8413345132077	12	11,99	537
216100120	8413345132084	12	12,96	537
216500300	8413345407274	12	7,54	537



216500500	8413345407281	12	7,98	537
216500750	8413345407298	12	10,08	537
216501000	8413345407304	12	11,33	537
2171G-140	7314150116232	5	19,44	238
2171G-160	7314150116133	5	20,05	238
2171G-180	7314150116140	5	22,13	238
2171V-160	7314150126798	2	42,73	487
2171V-180	7314150126804	2	45,82	487
2171V-200	7314150466009	2	49,49	487
218	7311518017521	10	4,26	545
218-BULK	7311518140946	150	2,97	545
219	7311518140953	120	5,56	545
219001000	8413345029865	5	6,78	537
219001200	8413345029872	5	7,50	537
219001400	8413345029889	5	8,38	537
219001600	8413345029896	5	9,13	537
219002000	8413345029902	5	11,98	537
2190PD-150	7314150114016	5	55,03	241
219201000	8413345029667	5	10,98	537
219201200	8413345029674	5	12,02	537
219201400	8413345029681	5	14,75	537
219201600	8413345029698	5	16,36	537
219202000	8413345029704	5	20,54	537
219302500	8413345129466	10	19,26	537
219303000	8413345129473	10	20,67	537
219303500	8413345129480	10	22,05	537
21HDD-140	7314150231256	5	23,62	237
21HDD-140IP	7314150231263	5	21,98	237
21HDD-160	7314150231270	5	24,24	237
21HDD-160IP	7314150231287	5	22,63	237
21HDD-180	7314150231294	5	26,50	237
21HDD-180IP	7314150231300	5	24,85	237
21HDD-200	7314150231317	5	29,02	237
21HDD-200IP	7314150231324	5	27,37	237
21HDG-140	7314150231331	5	27,80	236
21HDG-140A	7314150237654	5	29,49	237
21HDG-140IP	7314150231348	5	26,16	236
21HDG-160	7314150231355	5	28,53	236
21HDG-160A	7314150237661	5	30,65	237
21HDG-160IP	7314150231362	5	26,89	236
21HDG-180	7314150231379	5	31,27	236
21HDG-180A	7314150237678	5	33,59	237
21HDG-180IP	7314150231386	5	29,63	236
21HDG-200	7314150231409	5	33,26	236
21HDG-200A	7314150238439	5	35,81	237
21HDG-200IP	7314150231416	5	31,63	236
21HDGC-140IP	7314150231423	5	27,38	237
21HDGC-160IP	7314150231430	5	28,49	237
21HDGC-180IP	7314150231447	5	30,94	237
21HDGC-200IP	7314150231454	5	32,54	237
221 D	7314150037070	5	15,16	251
221201200	8413345029711	5	5,67	538
221202000	8413345029728	5	6,91	538
221303000	8413345029735	5	10,09	538
221301200	8413345029742	5	5,67	538
221302000	8413345029759	5	6,73	538
221303000	8413345029766	5	10,09	538
222 D	7314150037087	5	15,68	251
22209004B	8413345401333	1	19,85	343
2223 D-150	7314150033591	5	29,99	255
2223 G-150	7314150113651	5	29,47	255
2223 S-150	7314150032983	3	34,02	488
2223V-160	7314150134113	2	53,57	489
223 D	7314150037094	5	16,71	251
2233 D-160	7314150114023	5	34,36	241
2233 D-200	7314150114030	5	42,21	241
2233 D-240	7314150114047	5	47,62	241
2233D-160IP	7314150114054	5	33,66	241
2233D-200IP	7314150114061	5	41,50	241
2233D-240IP	7314150114078	5	46,92	241
2235-160	7314150179695	1	51,97	242
224 D	7314150037100	5	18,84	251
225 D	7314150037117	5	28,82	251
225-PLUS	7311518029708	5	32,01	544
2250V-170	7314150128730	2	112,39	487
2250V-230	7314150128747	2	130,96	487
227-22	7314150419845	1	207,59	126
227-24	7314150419852	1	213,76	126
227-27	7314150419869	1	220,03	126
227-30	7314150419876	1	229,02	126
227-32	7314150419883	1	233,40	126
227-34	7314150419890	1	257,63	126
227-36	7314150419906	1	264,20	126
227-41	7314150419913	1	286,34	126
227-46	7314150419920	1	343,51	126
228	7311518014995	80	11,83	545
228-15-5P	7311518031442	10	4,26	546
228-22	7314150420070	1	231,24	127
228-24	7314150420087	1	231,24	127
228-27	7314150420094	1	231,24	127
228-30	7314150420100	1	240,43	127
228-32	7314150420117	1	245,16	127
228-32-100P	7311518150990	1	29,54	546
228-32-10P	7311518010867	10	5,05	546
228-32-5P	7311518031459	10	4,26	546
228-34	7314150420124	1	263,64	127

\* Hasta agotar existencias



228-36	7314150420131	1	277,48	127
228-41	7314150420148	1	300,58	127
228-46	7314150420155	1	360,71	127
228-BULK	7311518009069	5	10,77	545
228-SD	7311518277048	24	24,39	159
228-SET-SD	7314150217946	1	134,18	160
229-SD	7311518277055	24	33,43	159
22F-3/4	7314150419821	1	258,51	125
22R-3/4	7314150419838	1	264,22	125
23-15	7311518274665	10	2,81	619
23-21	7311518012274	10	4,97	619
23-24	7311518003852	10	5,31	619
23-30	7311518003869	10	5,95	619
23-32	7311518003876	10	6,18	619
23-36	7311518003883	10	6,57	619
230-SD	7311518280956	25	75,12	159
2308B0000*	8413345091626	6	19,95	538
232-SD	7314150214839	1	127,77	160
233-300	7311518044015	5	19,44	553
233-300-A	7311518044039	5	26,64	553
233-400	7311518044022	5	28,34	553
2339 D	7314150032792	3	20,79	240
2339 DIP	7314150103508	5	20,10	240
2339-220	7314150442461	3	16,57	240
2339-220IP	7314150101061	5	15,97	240
2339-250IP	7314150101078	5	17,95	240
2339-280IP	7314150101948	5	20,42	240
2339-300IP	7314150123865	6	27,30	240
2339D-300	7314150411245	5	25,17	240
2339D-300IP	7314150411238	6	24,57	240
234-A1	7311518013653	1	21,14	553
234-A2	7311518013660	1	22,32	553
234-SD	7314150214846	25	142,95	160
234-W1	7311518013608	10	8,98	553
234-W2	7311518013615	10	11,19	553
234-W3	7311518013622	10	14,46	553
238	7311518011314	60	12,06	545
239	7311518010874	150	5,98	545
2420 G-125	7314150102525	5	27,15	248
2420G-125IP	7314150447091	5	21,98	248
2421 D-140IP	7314150101979	5	23,49	248
2421 D-160IP	7314150101986	5	25,89	248
2421 D-180IP	7314150101993	5	30,89	248
2421 G-140	7314150102532	5	28,70	248
2421 G-140IP	7314150102006	5	27,97	248
2421 G-160	7314150102549	5	31,54	248
2421 G-160 IP	7314150100576	5	30,80	248
2421 G-180	7314150102556	5	37,88	248
2421 G-180 IP	7314150100583	5	37,16	248
2421GC-140IP	7314150447107	5	23,46	248
2421GC-160IP	7314150447114	5	25,79	248
2421GC-180IP	7314150233229	5	26,15	248
2421S-140	7314150447121	3	33,58	488
2421S-160	7314150447138	3	33,58	488
2421S-180	7314150447145	3	44,62	488
2421V-160	7314150126774	2	39,86	488
2427 D-160	7314150032846	5	27,82	246
2427 D-200	7314150169030	5	30,08	246
2427 G-160	7314150100408	5	30,35	246
2427 G-160 IP	7314150100743	5	29,63	246
2427 G-200	7314150100415	5	34,71	246
2427 G-200 IP	7314150100750	5	34,02	246
2427 GC-160IP	7314150102051	5	25,30	246
2427 GC-200IP	7314150102075	5	28,98	246
2427 S-200	7314150033027	3	35,00	488
2427S-160	7314150447008	3	34,73	488
2427V-200	7314150126903	2	53,57	488
2430 D-140	7314150032853	5	24,68	245
2430 D-140 IP	7314150100774	5	24,00	245
2430 D-160	7314150032860	5	26,63	245
2430 D-160 IP	7314150100781	5	25,88	245
2430 D-200	7314150032884	5	28,86	245
2430 D-200 IP	7314150100804	5	28,15	245
2430 G-140	7314150102563	5	27,90	244
2430 G-140 IP	7314150102143	5	27,20	244
2430 G-160	7314150024070	5	29,47	244
2430 G-160 IP	7314150100811	5	28,75	244
2430 G-200	7314150100422	5	33,80	244
2430 G-200 IP	7314150100835	5	33,09	244
2430 GC-140 IP	7314150102150	5	23,26	245
2430 GC-160 IP	7314150102167	5	24,32	245
2430 GC-200 IP	7314150102174	5	28,00	245
2430 S-160	7314150206742	3	28,59	488
2430 S-200	7314150033010	3	31,34	488
2430S-140	7314150446995	3	27,92	488
2430V-160	7314150126880	2	47,51	488
2430V-200	7314150126897	2	47,84	488
2431G-125	7314150447015	5	26,35	245
2431G-125IP	7314150447053	5	25,85	245
2431G-140	7314150447022	5	26,89	245
2431G-140IP	7314150447060	5	26,32	245
2431G-160	7314150447039	5	27,38	245
2431G-160IP	7314150447077	5	26,77	245
2431G-180	7314150447046	5	28,38	245
2431G-180IP	7314150447084	5	27,62	245
244-20-U7/8-HP	7311518012519	10	25,17	551



# 244-22-U7/8-HP



244-22-U7/8-HP	7311518012526	10	26,18	551
2446	7314150128648	15	11,42	569
2446-BL	7314150508242	15	9,65	570
2446-EL	7314150270736	12	9,66	570
2446-EL-HELP	7314150394500	12	10,56	570
2446-ELL	7314150370153	12	9,66	570
2446-ELR	7314150370146	12	9,66	570
2446-LAP	7314150500828	15	8,59	569
2446-LINO	7314150270750	12	8,98	570
2446-OV	7314150313662	15	11,42	570
2446-SAFE	7314150453078	15	9,40	570
2448	7314150136049	12	30,81	560
2449	7314150194056	12	28,31	560
244P-20-U7-HP	7311518235499	4	28,31	553
244P-22-U7-HP	7311518235482	10	29,41	553
2460	7314151063467	1	54,44	254
2461 C19	7314151063498	1	76,17	253
2461 C40	7314151063504	1	87,61	253
2461 C8	7314151063481	1	73,50	253
2463 D19	7314151063511	1	78,13	253
2463 D40	7314151063528	1	89,81	253
2463 D8	7314151588878	1	64,16	253
2464 A10	7314151063535	1	79,41	253
2464 A19	7314151063542	1	86,39	253
2464 A3	7314151406516	1	79,41	253
2464 A40	7314151063559	1	94,78	253
2465D-200	7314150120826	1	60,57	254
2466 B10	7314151063573	1	80,96	254
2466 B19	7314151063580	1	88,48	254
2466 B3	7314151406868	1	80,96	254
2466 B40	7314151063597	1	99,63	254
247-24	7314150367078	1	197,46	123
247-27	7314150367085	1	197,46	123
247-30	7314150367092	1	200,05	123
247-32	7314150367108	1	200,05	123
247-34	7314150367115	1	200,05	123
247-36	7314150367122	1	205,20	123
247-41	7314150367139	1	205,20	123
247-46	7314150367146	1	209,06	123
247-50	7314150367153	1	214,22	123
247-55	7314150367160	1	220,69	123
247-60	7314150367177	1	224,55	123
2470 G-160	7314150116188	5	18,85	246
2470 G-200	7314150116195	5	20,94	246
2471 G-160	7314150116225	5	17,25	249
2471 G-180	7314150134939	5	18,55	249
2477 G-200	7314150116201	5	23,34	247
2477G-160	7314150134977	5	18,42	247
248-24	7314150367818	1	201,32	124
248-27	7314150367825	1	201,32	124
248-30	7314150367832	1	206,48	124
248-32	7314150367849	1	206,48	124
248-34	7314150367856	1	206,48	124
248-36	7314150367863	1	210,36	124
248-41	7314150367870	1	220,69	124
248-46	7314150367887	1	215,53	124
248-50	7314150367894	1	215,53	124
248-55	7314150367900	1	263,26	124
248-60	7314150367917	1	263,26	124
2484-20	7314150233250	1	10,16	364
2484-30	7314150233267	1	13,06	364
2484-45	7314150233274	1	20,30	364
2484-60	7314150233281	1	24,66	364
2484/S4	7311518276553	10	50,78	364
2484T-20	7314150455102	1	13,60	364
2484T-30	7314150455119	1	19,43	364
2484T-45	7314150455126	1	26,53	364
2484T-60	7314150455133	1	31,36	364
2484T/S4	7314150455096	1	81,85	364
2485	7314150242382	1	9,59	342
2487	7311518276058	12	17,88	524
2488	7311518276072	12	19,77	538
2489	7311518276065	12	24,30	538
24A-14	7314150368235	1	114,86	125
24A-27	7314150368242	1	181,97	125
24F-1	7314150366231	1	277,46	122
24F-3/4	7314150366224	1	237,46	122
24R-1	7314150366951	1	309,72	121
24R-3/4	7314150366944	1	187,13	121
24T-1	7314150366156	1	374,26	122
24T-3/4	7314150366149	1	283,91	122
24W	7314150368266	1	70,99	125
2500-16-XT-HP	7311518160159	4	45,52	551
2500-19-XT-HP	7311518160722	4	46,92	551
2500-22-XT-HP	7311518140922	4	48,29	551
2500-24-XT7-HP	7311518181338	4	50,18	551
250400010	73141503144430	1	42,11	540
250400020	7314150393008	1	74,27	540
250400030	7314150393015	1	139,53	540
250501800	8413345128964	50	67,85	540
2509	7314151064280	50	79,63	365
2520	7314150023752	1	180,74	241
2521 G-140	7314150100293	5	28,48	249
2521 G-160 IP	7314150100620	5	29,45	249
2521D-140IP	7314150447176	5	20,58	249
2521D-160IP	7314150447183	5	24,25	249



2521G-140IP	7314150447169	5	28,86	249
2521G-160	7314150447152	5	31,38	249
2521S-140	7314150447190	3	33,31	488
2521S-160	7314150447206	3	35,05	488
2521V-160	7314150126781	2	40,50	488
2530	7314150326761	1	6,85	365
2530-40	7314151317294	5	48,22	524
2535F0	7314150402236	1	18,41	365
2535F1	7314151064495	1	40,57	365
2535F2	7314150233854	1	36,76	365
2535F3	7314150180233	1	66,59	365
2535L	7314150125357	12	28,11	365
255-17/34	7314150272372	2	58,55	549
255-34	7314150272365	2	66,79	549
2555	7311518276041	1	8,44	305
256-26	7311518000080	4	71,47	549
2600-16-XT11-HP	7311518239527	4	58,28	550
2600-19-XT-HP	7311518160760	4	60,51	551
2600-22-XT-HP	7311518160777	4	62,37	551
2620-80	7311518200947	1	292,17	241
2628 D-160	7314150123193	5	21,43	243
2628 D-180	7314150042661	5	24,51	243
2628 D-200	7314150123315	5	25,79	243
2628 G-160	7314150042999	5	25,50	243
2628 G-160IP	7314150055357	5	24,78	243
2628 G-180	7314150042678	5	27,99	243
2628 G-180IP	7314150044030	5	27,30	243
2628 G-200	7314150110359	5	29,85	243
2628 GC-160IP	7314150101863	5	19,78	243
2628 GC-180IP	7314150101870	5	21,36	243
2628 GC-200IP	7314150101887	5	23,49	243
2628 S-160	7314150206735	3	30,70	487
2628 S-180	7314150044054	3	34,02	487
2628 S-200	7314150043002	3	37,20	487
2628G-200IP	7314150101085	5	29,15	243
2629G-160	7314150446933	5	25,50	243
2629G-160IP	7314150446964	5	24,78	243
2629G-180	7314150446940	5	27,90	243
2629G-180IP	7314150446971	5	27,30	243
2629G-200	7314150446957	5	29,85	243
2629G-200IP	7314150446988	5	29,15	243
2630DC-160IP	7314150446896	5	18,43	244
2630DC-180IP	7314150446902	5	19,65	244
2630DC-200IP	7314150446919	5	22,59	244
2630GC-160IP	7314150180165	5	20,38	243
2630GC-180IP	7314150180172	5	20,54	243
2630GC-200IP	7314150180189	5	23,49	243
2630SC-180	7314150446926	3	26,03	487
2632	7314151065706	1	23,72	364
2633/S4	7311518276942	12	26,65	523
2633HD/S6	7314150205783	1	136,84	311
2633HD1	7314150230464	1	44,41	311
2633HD2	7314150230471	1	19,64	311
2633HD3	7314150230488	1	17,04	311
2633HD4	7314150230495	1	13,15	311
2633HD5	7314150230501	1	12,40	311
2633HD6	7314150230518	1	7,16	311
2633L/S4	7311518276959	12	27,15	523
2635	7311518276348	1	62,46	595
2640D-160	7314150123766	10	19,80	244
2640D-180	7314150123773	5	22,43	244
2640D-200	7314150123797	5	25,20	244
2646	7314151304638	1	84,23	239
2646 A	7314151304645	1	95,86	239
2646 AK	7314151396619	1	91,99	239
2646 K	7314151495862	1	95,39	239
2646 M	7314151487928	1	93,35	238
2646 MF	7314151573683	1	72,71	249
2646 MS	7314151573768	1	80,61	250
2646 R	7314151304706	1	79,12	238
2646 RA	7314151834838	1	93,49	238
2646 RK	7314151496678	1	119,63	238
2648	7314151304713	1	79,60	239
2648 A	7314151304720	1	113,64	239
2649	7314150058013	1	90,23	238
2650	7314151065829	1	74,88	252
2650 B	7314151065843	1	6,66	252
2656	7314151304737	1	87,53	241
2656 R	7314151473976	1	83,79	247
2656 S	7314150058044	1	67,10	246
2666	7314150058006	1	84,23	238
2666 FK	7314151066079	1	98,88	239
2674 NB	7314151066321	1	84,86	238
2674 NVDE	7314151498535	1	88,74	487
2676 B	7314151066390	1	87,80	238
2678 B	7314151066468	1	98,08	238
2678 G-160	7314150116157	5	16,56	244
2678 G-180	7314150116164	5	17,61	244
2678 G-200	7314150116171	5	19,03	244
2678V-160	7314150126835	2	43,03	487
2678V-180	7314150126842	2	46,92	487
2678V-200	7314150126859	2	50,46	487
268	7311518017538	5	13,58	545
2681	7311518276706	12	41,69	266
2681-1	7314150116980	1	3,56	267
2688D-250	7314150123520	3	42,81	244





2690	7314150411108	10	60,05	267
26S-1216	7314151830236	8	27,27	61
26S-16	7314150345588	5	7,78	61
26S-610	7314151830229	10	11,68	61
2700-22-XT7-HP	7311518191672	4	63,56	553
2700-24-XT7-HP	7311518191665	4	64,48	553
2704A	7314151066963	1	36,61	566
2705R	7314151821470	1	31,65	566
2720	7314150179701	1	250,35	242
2720-SH	7314150179718	1	191,44	242
277-30	7314150367184	1	220,69	123
277-32	7314150367191	1	220,69	123
277-34	7314150367207	1	220,69	123
277-36	7314150367214	1	225,84	123
277-41	7314150367221	1	247,78	123
277-46	7314150367238	1	252,94	123
277-50	7314150367245	1	259,41	123
277-55	7314150367252	1	267,13	123
277-60	7314150367269	1	272,30	123
278-30	7314150367924	1	250,35	124
278-32	7314150367931	1	250,35	124
278-34	7314150367948	1	250,35	124
278-36	7314150367955	1	254,22	124
278-41	7314150367962	1	267,13	124
278-46	7314150367979	1	260,68	124
278-50	7314150367986	1	260,68	124
278-55	7314150367993	1	263,26	124
278-60	7314150368006	1	263,26	124
2784-2.5	7314150215607	1	36,85	221
2784-3.5	7314150215614	1	36,85	221
2784-4.5	7314150215621	1	36,85	221
2787 F	7314151474270	1	123,97	239
2787 G	7314150058020	1	135,36	239
27A-24	7314150368259	1	215,53	125
27F-1	7314150366248	1	329,10	122
27M-10-11	7314150180523	10	14,67	60
27M-12-13	7314150180547	10	17,32	60
27M-13-17	7314150180790	10	23,08	60
27M-14-15	7314150180554	10	19,36	60
27M-16-17	7314150180561	10	22,46	60
27M-16-18	7314150180806	10	23,89	60
27M-18-19	7314150180578	10	26,83	60
27M-20-22	7314150180585	10	30,61	60
27M-21-23	7314150180592	5	34,04	60
27M-21-24	7314150180813	5	35,56	60
27M-24-26	7314150180608	5	36,36	60
27M-24-27	7314150180820	5	37,00	60
27M-25-28	7314150180622	5	41,82	60
27M-27-29	7314150180639	5	47,76	60
27M-30-32	7314150180646	5	53,52	60
27M-6-7	7314150180509	10	13,67	60
27M-8-9	7314150180516	10	13,81	60
27M/10	7314150180677	1	229,09	61
27M/12	7314150180684	1	324,45	61
27M/12T	7314150180783	1	330,91	60
27M/6	7314150180653	1	101,30	60
27M/8	7314150180660	1	158,71	61
27M/8T	7314150180776	1	163,03	60
27R-1	7314150365968	1	354,90	121
27T-1	7314150366163	1	412,97	122
28-29/S4	7314150179688	1	110,56	254
2800 N	7314151318338	1	72,08	242
2800-140	7314150121632	3	20,28	252
2800-150	7314150034567	3	20,28	252
2800-180	7314150034581	3	23,15	252
2800-225	7314150034604	3	29,15	252
2800-300	7314150122622	1	39,96	252
2801 N	7314151318352	1	88,82	242
2804	7314151692698	1	449,35	242
2805-280	7314151826123	1	525,52	242
2820EF1	7314150122042	12	9,87	572
2820EF2	7314150122059	8	12,69	572
2820EF3	7314150122066	1	16,43	572
2820EF4	7314150122073	1	20,53	572
2820EK	7314150122035	6	7,91	572
2820EK-01	7314150270743	12	6,20	571
2820VBC	7314150121915	1	234,14	487
2820VDE	7314151605476	10	25,06	491
2820VFP	7314150121922	1	125,86	491
2820VG05	7314150121953	1	70,58	491
2820VG10	7314150121960	1	84,88	491
2820VGCOT	7314150121977	1	5,04	491
2820VM	7314150121946	1	234,74	491
2820VP	7314150121885	2	30,98	490
2820VPC	7314150121892	2	33,61	491
2820VTEE	7314150121939	1	33,26	491
2855	7314151825805	1	159,00	268
2855 D	7314151822569	1	201,28	268
2856-10*	7314150437214	1	323,95	268
2856-8*	7314150437207	1	323,95	268
2890-125	7314150122639	3	17,58	252
2890-140	7314150034550	3	20,60	252
2890-180	7314150034574	3	23,90	253
2890-210	7314150034598	3	30,08	253
2890-300	7314150122646	1	44,93	253
28M-10	7314151834678	5	13,61	58

\* Hasta agotar existencias



28M-11	7314151834685	5	14,21	58
28M-12	7314151834692	5	15,07	58
28M-13	7314151834708	5	16,18	58
28M-14	7314151834715	5	18,54	58
28M-15	7314151834722	5	19,64	58
28M-16	7314151834739	5	20,71	58
28M-17	7314151834746	5	21,56	58
28M-18	7314151834753	3	26,01	58
28M-19	7314151834760	3	27,45	58
28M-20	7314150122561	3	29,42	58
28M-21	7314151834777	3	31,98	58
28M-22	7314151834784	3	37,14	58
28M-23	7314150122578	3	38,68	58
28M-24	7314151834791	3	40,99	58
28M-25	7314150122585	3	46,78	58
28M-26	7314150122592	3	50,81	58
28M-27	7314151834807	3	55,49	58
28M-28	7314150122608	1	63,89	58
28M-29	7314150122615	1	72,85	58
28M-30	7314151834814	1	82,68	58
28M-32	7314151834821	1	98,54	58
28M-6	7314151834630	5	15,19	58
28M-7	7314151834647	5	15,82	58
28M-8	7314151834654	5	13,02	58
28M-9	7314151834661	5	12,90	58
28M/11	7314151838126	1	206,05	59
28M/12	7314151838133	1	215,62	59
28M/15	7314151838140	1	325,75	59
28M/8	7314151838119	1	150,06	59
28MV-10	7314150121298	2	37,96	489
28MV-11	7314150121304	2	38,44	489
28MV-12	7314150121311	2	38,78	489
28MV-13	7314150121328	2	39,11	489
28MV-14	7314150121335	2	43,82	489
28MV-15	7314150121342	2	44,32	489
28MV-16	7314150121359	2	45,51	489
28MV-17	7314150121366	2	46,15	489
28MV-18	7314150121373	2	47,45	489
28MV-19	7314150121380	2	47,45	489
28MV-20	7314150121397	2	47,30	489
28MV-21	7314150121403	2	47,63	489
28MV-22	7314150121410	2	49,90	489
28MV-8	7314150121274	2	37,61	489
28MV-9	7314150121281	2	37,61	489
29-B	7311518277703	1	33,29	323
2900-140	7314150121045	3	21,63	253
2900-150	7314150034499	3	21,63	253
2900-180	7314150034512	3	23,61	253
2900-215	7314150034536	3	29,15	253
2900-300	7314150121076	1	45,55	253
2928-1	7314150056583	1	15,84	254
2928-160	7314150056514	1	58,85	254
2928-2	7314150056590	1	15,84	254
2928-200	7314150056521	1	83,08	254
2928-250	7314150056538	1	118,82	254
2928-3	7314150056606	1	15,84	254
2928-4	7314150056613	1	15,84	254
2949-190IP	7314150123926	1	64,18	266
2949-200IP	7314150123940	1	68,08	266
2949-240IP	7314150123957	1	71,36	266
2949-250IP	7314150123971	1	88,65	266
2949-L075	7314150440559	1	5,89	266
2949-L120	7314150440566	1	6,14	266
2949-L200	7314150440573	1	7,55	266
2950-250	7314150124039	1	35,00	262
2951-140	7314150124084	1	18,67	262
2951-180	7314150102204	1	25,52	262
2951-250	7314150102211	1	29,40	262
2951-300	7314150102228	1	49,48	262
2951-S05	7314150447299	1	3,73	265
2951-S07	7314150447305	1	3,73	265
2951-S10	7314150447312	1	3,73	265
2951-S12	7314150447329	1	3,73	265
2952-165	7314150103836	1	22,23	263
2952-235	7314150103843	1	31,74	263
2953-140	7314150124046	1	17,44	262
2953-200	7314150124053	1	23,19	262
2953-250	7314150124060	1	26,46	262
2953-300	7314150124077	1	45,73	262
2955-250	7314150102235	1	33,44	263
2956-290	7314150413690	1	46,05	265
2957-250	7314150102259	1	27,84	263
2958-140	7314150124107	1	18,51	263
2958-200	7314150124114	1	25,52	263
2958-250	7314150102242	1	29,40	263
296	7311518034146	1	155,86	555
2960-280	7314150412808	1	55,88	264
2962-8-150	7314150412815	1	58,58	265
2962-8-230	7314150413706	1	75,28	265
2962-8-300	7314150413713	1	81,66	265
2963-280	7314150102280	1	39,05	264
2963-450	7314150124138	1	64,09	264
2963-630	7314150124145	1	77,07	264
2964-160	7314150124183	1	32,20	264
2964-280	7314150102297	1	42,46	264
2964-450	7314150124190	1	71,70	264



# 2964-600



2964-600	7314150124206	1	83,98	264
2965-200	7314150124152	1	33,60	265
2965-280	7314150102266	1	44,50	265
2966-280	7314150102273	1	45,57	265
2967-180	7314150102396	1	40,45	263
2968-190	7314150124091	1	25,52	263
2968-235	7314150103850	1	29,40	263
2970G-200	7314150134946	5	17,76	244
2971G-250	7314150117154	5	16,00	251
2979 D-180	7314150034246	5	42,31	249
2990-125	7314150121250	3	22,16	253
2990-140	7314150034482	3	22,16	253
2990-180	7314150034505	3	24,90	253
2990-200	7314150034529	3	30,08	253
2990-300	7314150121267	1	44,34	253
2997-250	7314150124237	1	70,01	266
2997-300	7314150124244	5	77,14	265
2998-250	7314150124213	1	94,73	264
2998-SHN	7314150447275	1	55,26	264
2999-250	7314150124169	1	50,08	264
2999-SHN	7314150447282	1	14,74	264
29M-10	7314150122318	5	13,61	59
29M-11	7314150122325	5	14,12	59
29M-12	7314150122332	5	15,30	59
29M-13	7314150122349	5	15,86	59
29M-14	7314150122356	5	18,54	59
29M-15	7314150122363	5	19,64	59
29M-16	7314150122370	5	20,71	59
29M-17	7314150122387	5	20,90	59
29M-18	7314150122394	3	26,01	59
29M-19	7314150122400	3	27,45	59
29M-20	7314150122417	3	29,42	59
29M-21	7314150122424	3	31,98	59
29M-22	7314150122431	3	37,14	59
29M-23	7314150122448	3	38,68	59
29M-24	7314150122455	3	40,99	59
29M-25	7314150122462	3	46,78	59
29M-26	7314150122479	3	50,81	59
29M-27	7314150122486	3	55,49	59
29M-28	7314150122493	1	63,89	59
29M-29	7314150122509	1	72,85	59
29M-30	7314150122516	1	82,68	59
29M-32	7314150122523	1	98,54	59
29M-6	7314150122271	5	15,19	59
29M-7	7314150122288	5	15,82	59
29M-8	7314150122295	5	13,62	59
29M-9	7314150122301	5	13,52	59
29M/10	7314150122547	1	183,46	59
29M/14	7314150122554	1	318,79	59
29M/8	7314150122530	1	163,55	59
2M-10-11	7314151001223	5	12,39	54
2M-10-13	7314151001513	5	15,71	54
2M-12-13	7314151001230	5	13,32	54
2M-13-17	7314151343972	5	14,53	54
2M-14-15	7314151001247	5	14,12	54
2M-16-17	7314151001254	5	16,87	54
2M-16-18	7314151001575	5	20,16	54
2M-17-19	7314151000844	5	19,66	54
2M-18-19	7314151001261	5	19,66	54
2M-19-22	7314151000868	5	23,25	54
2M-20-22	7314151001278	5	24,12	54
2M-21-23	7314151001285	5	25,75	54
2M-22-24	7314151001612	5	28,09	54
2M-24-26	7314151001292	5	31,83	54
2M-24-27	7314151000899	5	32,32	54
2M-25-28	7314151001308	5	37,12	54
2M-27-29	7314150205332	5	38,18	54
2M-27-30	7314151001636	5	45,40	54
2M-27-32	7314151001322	5	45,40	54
2M-30-32	7314151000929	5	45,27	54
2M-32-36	7314151001667	1	66,51	54
2M-36-41	7314151001681	1	78,99	54
2M-41-46	7314151001704	1	104,41	54
2M-46-50	7314151001711	1	128,87	54
2M-6-7	7314151001209	5	10,69	54
2M-8-10	7314151001506	5	13,58	54
2M-8-9	7314151001216	5	11,71	54
2M/10T	7314150212996	1	185,93	54
2M/12T	7314151001414	1	267,21	55
2M/8T	7314151001391	1	125,71	54
2M/S8	7314151827335	1	121,40	54
2MV-10	7314150121113	5	31,65	489
2MV-11	7314150121120	5	31,94	489
2MV-12	7314150121137	5	31,94	489
2MV-13	7314150121144	5	34,26	489
2MV-14	7314150121151	5	35,22	489
2MV-15	7314150121168	5	36,52	489
2MV-16	7314150121175	5	37,03	489
2MV-17	7314150121182	3	38,16	489
2MV-18	7314150121199	3	38,84	489
2MV-19	7314150121205	3	40,14	489
2MV-21	7314150121212	3	42,24	489
2MV-22	7314150121229	3	42,56	489
2MV-23	7314150121236	3	45,34	489
2MV-24	7314150121243	3	46,80	489
2MV-6	7314150121069	5	29,56	489



2MV-7	7314150121083	5	29,56	489
2MV-8	7314150121090	5	31,13	489
2MV-9	7314150121106	5	31,74	489
2Z-1-1.1/8	7314151001827	1	37,93	54
2Z-1.1/16-1.1/4	7314151001834	1	41,97	54
2Z-1/2-9/16	7314151001445	1	13,54	54
2Z-1/4-5/16	7314151001421	1	12,21	54
2Z-13/16-7/8	7314151001797	1	23,25	54
2Z-15/16-1	7314151001810	1	32,01	54
2Z-3/4-7/8	7314151001773	1	23,25	54
2Z-3/8-7/16	7314151001438	1	13,65	54
2Z-5/16-3/8	7314151001728	1	11,93	54
2Z-5/8-11/16	7314151001452	1	17,31	54
2Z-9/16-5/8	7314151001735	1	14,53	54
2Z/7T	7314150217373	1	111,48	55
3-24-51	7315962500028	5	19,00	619
3-330-12-1-0	7311518020712	5	27,39	33
3-330-12-2-0	7311518020729	5	29,24	33
3-330-14-1-0	7311518020736	5	29,43	33
3-330-14-2-0	7311518020743	5	33,78	33
3-331-14-1-0	7311518020750	5	29,98	33
300-14-F15/16-HP	7311518005955	4	20,62	549
301	7311518001384	50	19,37	555
301-16	7314150456048	12	28,18	272
301-22	7311518293673	12	26,90	272
302	7311518013349	30	18,92	554
302-15-95	7314150486632	100	6,55	273
302-35	7311518293680	6	42,77	272
302-511W-12P	7311518207786	1	4,70	555
302-51W-12P	7311518013356	1	3,23	555
302-53W-12P	7311518013363	1	3,23	555
302-55W-12P	7311518013370	1	3,23	555
302-57W-12P	7311518013387	1	3,82	555
302-59W-12P	7311518207779	1	4,34	555
302-6X4P	7311518017590	1	10,31	555
302-71M-12P	7311518013394	1	5,38	555
302-73M-12P	7311518013400	1	5,39	555
302-75M-12P	7311518013417	1	6,48	555
302-76-95*	7314150188345	1	6,30	272
302-76N	7314150456307	6	97,38	272
302-77M-12P	7311518207793	1	7,00	555
302-81S-12P	7311518013677	1	4,57	555
302-83S-12P	7311518013684	1	4,57	555
302-85S-12P	7311518207809	1	5,17	555
302-95-SET	7314150456321	1	25,62	273
303-5P	7311518031435	10	5,20	555
304	7311518265533	10	8,13	544
3045/1VDE	7314151783815	1	456,82	492
3045V-1	7314150128785	1	312,74	492
3045V-2	7314150128792	1	782,42	492
3046-REF	7311518276966	1	137,31	305
306	7311518265540	10	15,59	544
306-10	7314150120246	1	32,30	272
306-12	7314150120253	1	34,13	272
306-15	7311518297107	12	35,94	272
306-15-95	7311518297329	1	12,42	273
306-22	7311518297114	12	39,52	272
306601500	8413345098700	5	22,74	574
306602000	8413345098717	5	24,45	574
306603000	8413345217033	5	27,51	574
306604000	8413345217095	5	30,26	574
306703000	8413345217194	5	29,64	574
306704000	8413345098755	5	32,09	574
306705000	8413345098762	5	34,99	574
306706000	8413345098779	5	37,29	574
306708000	8413345098786	5	42,78	574
306710000	8413345098793	5	48,61	574
306712000	8413345123334	2	54,70	574
306715000	8413345123341	2	62,64	574
306803000	8413345098809	5	53,02	574
306804000	8413345098816	5	56,55	574
306805000	8413345098823	2	59,78	574
306806000	8413345098830	2	62,56	574
306808000	8413345098847	2	68,59	574
306810000	8413345098854	2	73,86	574
306812000	8413345098861	2	78,37	574
306815000	8413345098878	1	85,21	574
306820000	8413345098885	1	93,58	574
306903000	8413345123402	2	85,25	574
306904000	8413345123419	2	88,46	574
306905000	8413345123426	2	91,66	574
306906000	8413345123433	2	94,74	574
306908000	8413345123457	2	101,00	574
306910000	8413345123471	2	107,11	574
307401B	7314150254958	1	35,18	271
307411B	7314150254965	1	52,60	271
307421B	7314150254972	1	84,82	271
307431B	7314150254989	1	140,93	271
307441	7314150235933	1	192,19	271
307451	7314150235940	1	281,87	271
308504000	8413345035156	1	368,36	532
308505000	8413345035194	1	21,57	532
308506000	8413345035163	1	24,92	532
308508000	8413345035170	1	30,31	532
308510000	8413345035187	1	34,03	532
3090-20-XT11-HP	7311518181369	4	57,15	551





31	7314150004942	5	38,37	42
31 IP	7314150004959	50	36,95	42
31-T	7314150483709	5	36,95	42
31-T IP	7314150483723	50	36,95	42
3100TB	7314150125364	1	51,18	452
310M-24	7314151829612	1	57,81	58
310M-27	7314151829629	1	57,81	58
310M-30	7314151829636	1	57,81	58
310M-32	7314151829643	1	61,38	58
310M-36	7314151829650	1	70,20	58
310M-38	7314151829667	1	84,47	58
310M-41	7314151829674	1	86,27	58
310M-46	7314151829681	1	96,19	58
310M-50	7314151829698	1	115,82	58
310M-55	7314151829704	1	129,64	58
310M-60	7314151829711	1	159,47	58
310M-65	7314151829728	1	180,32	58
310M-70	7314151829735	1	196,57	58
310M-75	7314151829742	1	214,42	58
310M-80	7314151829759	1	235,55	58
310M-85	7314151829766	1	253,43	58
310M-90	7314151829773	1	503,60	58
310M-95	7314151829780	1	545,83	58
311-32	7314150120215	6	22,28	273
3115	7314150055326	1	368,36	358
3149-OR	7311518292249	1	46,49	447
3149-ORFF1	7314150292479	1	578,27	447
3149-ORTS1	7314150292066	1	383,55	447
3150-12-XT9-HP	7311518181406	4	36,73	548
315M-27	7314150133291	1	77,70	58
315M-30	7314150133307	1	79,18	58
315M-32	7314150133314	1	77,70	58
315M-36	7314150133321	1	107,56	58
315M-41	7314150133345	1	110,58	58
315M-46	7314150133352	1	143,46	58
315M-50	7314150133369	1	161,37	58
315M-55	7314150133376	1	185,29	58
315M-60	7314150133383	1	239,06	58
315M-65	7314150133390	1	271,93	58
315M-70	7314150133406	1	316,77	58
315M-75	7314150133413	1	328,73	58
315M-80	7314150133420	1	379,51	58
315Z-1.1/16	7314150133437	1	71,72	58
315Z-1.1/2	7314150133505	1	97,04	58
315Z-1.1/4	7314150133468	1	77,70	58
315Z-1.1/8	7314150133444	1	71,72	58
315Z-1.11/16	7314150133529	1	116,57	58
315Z-1.13/16	7314150133543	1	128,49	58
315Z-1.15/16	7314150133567	1	140,43	58
315Z-1.3/16	7314150133451	1	74,72	58
315Z-1.3/4	7314150133536	1	125,52	58
315Z-1.3/8	7314150133482	1	101,59	58
315Z-1.5/16	7314150133475	1	80,69	58
315Z-1.5/8	7314150133512	1	113,57	58
315Z-1.7/16	7314150133499	1	95,37	58
315Z-1.7/8	7314150133550	1	137,46	58
315Z-2	7314150133574	1	140,43	58
315Z-2.1/16	7314150133581	1	143,46	58
315Z-2.1/2	7314150133642	1	212,17	58
315Z-2.1/4	7314150133611	1	164,36	58
315Z-2.1/8	7314150133598	1	144,85	58
315Z-2.15/16	7314150133697	1	265,96	58
315Z-2.3/16	7314150133604	1	156,93	58
315Z-2.3/4	7314150133673	1	221,15	58
315Z-2.3/8	7314150133635	1	173,34	58
315Z-2.5/16	7314150133628	1	167,34	58
315Z-2.5/8	7314150133666	1	221,15	58
315Z-2.7/8	7314150133680	1	262,98	58
315Z-2.9/16	7314150133659	1	218,15	58
315Z-3	7314150133703	1	271,93	58
315Z-3.1/8	7314150133840	1	277,91	58
316-1	7311518296216	12	13,78	274
316-2	7311518296223	12	20,65	274
316-2-95	7311518296278	1	10,88	275
317	7311518240936	10	20,09	544
317-40	7311518296230	12	13,88	275
318-38	7311518296247	1	86,70	275
318-54	7311518296254	1	138,91	275
3180-14-XT11-HP	7311518181390	4	51,71	550
319	7311518240943	5	27,72	544
320	7311518265557	10	23,07	544
321	7311518001841	5	36,71	544
321-18-SB	7311518129125	10	19,56	546
321-24-SB	7311518129132	10	19,88	546
321-7-SB	7311518129149	10	18,34	546
322500300	8413345012829	1	45,36	522
322500500	8413345012836	1	48,07	522
322500800	8413345012843	1	51,13	522
322510300	8413345015899	1	8,87	522
322510500	8413345015905	1	8,87	522
322510600	8413345137393	1	8,87	522
322510700	8413345137409	1	8,87	522
322510800	8413345015912	1	8,87	522
3240-14-XT11-HP	7311518243005	4	43,61	550
325	7311518214852	5	49,68	544
325001000	8413345000505	1	85,92	522

\* Hasta agotar existencias



3250010SH	8413345137492	1	4,82	522
326000200	8413345000529	1	52,79	522
326000300	8413345012881	1	57,25	522
326010200	8413345016100	1	7,71	522
326020200	8413345016117	1	7,78	522
326030200	8413345016124	1	7,78	522
327020500	7314150330584	1	109,09	522
327020500-SH1	7314150361021	1	8,26	523
327020500-SH2	7314150361038	1	8,26	523
327020500-SH3	7314150361045	1	8,26	523
327020500-SH4	7314150361052	1	8,26	523
3280M	7314151071318	1	17,47	52
329000330	8413345000741	1	4,66	523
329000500	8413345000758	1	5,75	523
331-15-23	7311518274658	5	14,91	619
331-21-51-KP	7311518003814	5	15,95	619
332-21-51	7311518229337	5	18,89	619
333	7311518005832	5	30,33	619
333-5	7311518005849	10	7,51	620
339-6T	7311518128371	4	18,16	616
33H	7314150266791	5	68,37	42
340-6T	7311518002008	4	19,37	616
341	7314150113729	1	54,45	270
3416 A	7314150216260	6	45,41	255
3416 A SH	7314150410941	1	17,18	255
3416 B	7314150411160	10	157,29	255
3417 A	7314150216277	12	30,02	257
3418 A	7314150216284	1	36,25	256
3419 B	7314151812416	1	122,89	257
3419 B SH	7314150504381	1	37,27	257
342	7314150113736	1	61,26	270
343	7314150113743	1	82,40	270
344	7314150113750	1	123,32	270
349	7311518018924	4	12,00	620
3517 A	7314150410910	1	35,94	256
3518 A	7314150216376	1	25,06	256
3518 A SH	7314150216383	1	5,87	256
3518 B	7314150410927	1	45,68	256
3520 A	7314150410934	1	34,75	256
3520 A SH	7314150410958	1	5,84	256
3520 B	7314150411177	10	106,72	256
3520 B SH	7314150411207	10	30,58	256
3524	7314151073336	1	35,93	524
3524L-K	7314151339807	1	17,25	524
3525HB	7314151073350	5	27,84	524
36	7314150223381	5	47,00	579
361-10	7311518295202	1	34,17	271
361-12	7311518295219	1	39,85	271
361-14	7311518295226	1	42,72	271
361-18	7311518295233	1	59,78	271
361-24	7311518295240	1	99,35	271
361-36	7311518295257	1	191,26	271
361-8	7311518295196	1	30,72	271
3619 A	7314150411184	10	53,91	257
3619 A SH	7314150411214	10	14,62	257
3625AR-35	7314150214723	34	35,32	582
3625AR-50	7314150214730	18	58,34	582
3625AR-60	7314150214747	12	75,90	582
3625ARL-35	7314150214754	6	1,44	582
3625ARL-50	7314150214761	6	5,71	582
3625ARL-60	7314150214778	6	9,55	582
3625ARLH-35	7314150218677	80	4,74	583
3625ARLH-50	7314150218684	50	5,01	583
3625ARLH-60	7314150218691	16	5,27	583
3625N-22	7314151073602	6	46,26	583
3625N-32	7314151073640	6	49,97	583
3625N-40	7314151073688	6	84,08	583
3625N-50	7314151073701	6	101,88	583
3625NL-22	7314151073831	20	12,97	584
3625NL-32	7314151073855	20	22,10	584
3625NL-40	7314151073879	20	38,41	584
3625NL-50	7314151073886	20	64,13	584
3625NLH-32*	7314150247585	1	14,72	583
3625PU-105	7314150170098	4	257,88	583
3625PU-30	7311518276119	12	31,57	583
3625PU-50	7311518276126	6	52,11	583
3625PU-60	7311518276133	6	78,60	583
3625RM-55	7314150120758	50	11,24	584
3625RM-65	7314150120765	40	12,13	584
3625RM-75	7314153019820	30	14,54	584
3625RM-90	7314150120390	20	17,66	584
3625S-28	7314150183906	50	24,21	584
3625S-35	7314150183913	30	32,28	584
3625S-44	7314150183920	18	45,70	584
3625W-22	7314150120406	120	11,34	584
3625W-28	7314150120413	1	16,21	584
3625W-35	7314150120420	1	20,42	584
3625W-44	7314150120437	1	29,81	584
3625W-55	7314150120444	12	57,33	584
3625WL-22	7314150120451	10	4,32	584
3625WL-28	7314150120468	10	4,79	584
3625WL-35	7314150120475	10	5,83	584
3625WL-44	7314150120482	10	6,38	584
3625WL-55	7314150120499	6	8,44	584
3625WLH-22	7314150219025	50	3,49	584
3625WLH-28	7314150218981	50	3,68	584



# 3625WLH-35



3625WLH-35	7314150218998	80	3,94	584
3625WLH-44	7314150219001	50	4,61	584
3625WLH-55	7314150219018	16	4,88	584
3625Y-22	7314151074074	6	43,49	583
3625Y-32	7314151074098	6	62,38	583
3625Y-40	7314151074111	6	86,20	583
3625Y-50	7314151074128	6	121,49	583
3625YL-22	7314151074159	20	17,55	583
3625YL-32	7314151074173	20	30,48	583
3625YL-35*	7314151074180	1	36,90	583
3625YL-40	7314151074197	20	54,25	583
3625YL-50	7314151074203	20	89,94	583
363-32	7311518295578	1	48,44	271
3640-150-C	7314150180691	25	16,93	590
3640-175-C*	7314150180707	6	14,63	590
3640-200-C	7314150180714	25	19,51	590
3640-250-C	7314150180721	20	23,15	590
3640-300-C	7314150180738	25	29,66	590
3643-100	7314151074654	50	18,43	592
3643-120	7314151074678	50	20,74	592
3643-150	7314151074685	50	26,52	592
3644-120	7314151074708	50	15,45	592
3644-125	7314151074722	50	18,23	592
3644-130	7314151074746	50	22,04	592
3644-150	7314151074760	50	23,70	592
3644-165	7314151074777	50	24,43	592
3644-180	7314151074791	50	32,65	592
3644-200	7314151074807	50	37,01	592
3646-115	7314151074937	250	18,43	593
3646-125	7314151074944	250	18,43	593
3646-150	7314151074951	125	18,51	593
3646-165	7314151074968	125	18,68	593
3646-180	7314151074975	50	21,37	593
3646-200	7314151074982	50	25,67	593
3646/6	7314151074999	25	147,10	593
3649-125	7314150472413	50	9,88	590
3654BMS/7	7314150220816	1	102,95	596
3654R	7314151075132	1	163,22	593
3656-125	7314150472352	50	9,88	590
3656-150	7314150472376	50	13,95	590
3656-175	7314150472390	1	9,88	590
3656/10	7314151075279	1	269,88	594
3658A-2	7314151075293	125	18,72	593
3658A-3	7314151075309	125	18,91	593
3658A-4	7314151075316	125	18,91	593
3658A-5	7314151075323	125	18,98	593
3658A-6	7314151075330	125	18,98	593
3658A-8	7314151075347	50	18,98	593
3658A/6	7314151075354	30	139,87	594
3659-0-9	7314151075507	5	12,49	593
3659-1-4	7314151075514	5	12,72	593
3659-1-8	7314151597351	5	13,08	593
3659-2-4	7314151075538	5	14,06	593
3659-2-8	7314151597436	5	14,82	593
3659-3-4	7314151075552	5	15,13	593
3659-3-9	7314151075569	5	13,95	593
3659-6-0	7314151075576	5	15,41	593
3659/8	7314151075583	1	117,19	594
3659/8T	7314151472573	1	112,12	594
3680	7314151075835	1	66,26	364
3681-11	7314150132980	1	32,88	365
3681-16	7314150132997	1	39,47	365
3681-20	7314150133000	1	49,33	365
3683	7314151075866	1	54,87	364
3684-16	7314150133017	1	25,27	364
3684-18	7314150133024	1	34,72	364
3684-24	7314150133031	1	45,06	364
3684-30	7314150133048	1	75,73	364
369-BLADE	7311518016531	20	20,14	549
370-4	7311518296193	1	48,44	271
3717 A	7314150489916	1	28,39	257
3718 A	7314150489930	12	52,72	257
3719 A	7314150489954	12	40,55	257
372-1.1/2	7314150133239	1	116,73	271
372-12	7314150133284	1	1.101,39	271
372-2.1/2	7314150133246	1	215,97	271
372-4	7314150133253	1	275,33	271
372-6	7314150133260	1	473,05	271
372-8	7314150133277	1	640,24	271
3733-2	7314151834371	50	5,20	593
3733-3	7314151834388	50	5,20	593
3733-4	7314151834395	50	5,10	593
3733-5	7314151834401	50	5,10	593
3733-6	7314151834418	50	5,10	593
3733S/5	7314150220809	25	27,61	594
3734-2	7314151834296	50	8,80	593
3734-3	7314151834319	50	8,80	593
3734-4	7314151834326	50	8,80	593
3734-5	7314151834333	50	8,80	593
3734-6	7314151834340	50	8,80	593
3734-8	7314151834357	50	8,99	593
3734BMS/7	7314150220755	1	100,33	596
3734N-10-150	7314150218110	10	7,80	593
3734N-2-150	7314150218042	10	6,32	593
3734N-3-150	7314150218059	10	6,32	593
3734N-4-150	7314150218066	10	6,53	593



3734N-5-150	7314150218073	10	6,53	593
3734N-6-150	7314150218080	10	7,80	593
3734N-7-150	7314150218097	10	7,80	593
3734N-8-150	7314150218103	10	7,80	593
3734N-9-150	7314150218127	10	7,80	593
3734NS/9	7314150218134	10	64,02	594
3734S/6	7314151834470	5	69,24	594
3735-4-120	7314151834265	50	5,48	592
3735-5-120	7314151834272	50	6,76	592
3735-5-150	7314151834289	50	8,99	592
3735N-2-100	7314150217953	10	5,71	592
3735N-4-120	7314150217960	10	6,34	592
3735N-5-120	7314150217977	10	7,17	592
3735N-6-150	7314150217984	10	7,80	592
3735N-8-150	7314150217991	10	7,80	592
3735NS/4	7314150218004	25	28,45	592
3736M-200	7314150220878	30	16,25	591
3736M-250	7314151834142	25	21,36	591
3736M-300	7314151834159	10	28,31	591
3736M-400	7314151834166	10	37,34	591
3736MH-250	7314151834173	10	29,44	591
3736MH-300	7314151834180	10	36,18	591
3736MH-400	7314151834197	5	45,28	591
3736S/6	7314151834463	5	62,18	591
3739-250	7314151834203	25	21,47	591
3739-300	7314151834210	10	28,43	591
3739-400	7314151834227	10	37,54	591
3739H-250	7314151834234	15	29,60	591
3739H-300	7314151834241	10	36,38	591
3739H-400	7314151834258	10	45,51	591
3740-100	7314151834005	50	9,45	590
3740-125	7314151834012	50	11,38	590
3740-150	7314151834029	50	13,01	590
3740-175	7314151834036	25	13,77	590
3740-200	7314151834043	25	14,94	590
3740-250	7314151834050	10	15,72	590
3740-300	7314151834067	10	16,81	590
3745-150	7314151834081	50	14,05	590
3745-175	7314151834098	25	17,95	590
3745-200	7314151834104	20	19,04	590
3745-250	7314151834111	10	26,83	590
3749-125	7314150457915	50	7,06	590
375-8	7311518296209	1	48,44	271
3750	7314151834128	25	18,61	590
3750H	7314151834135	25	27,11	591
3756-125	7314150457892	50	7,06	590
3756-150	7314150457908	50	8,76	590
38-12	7314151831264	5	20,81	326
38-16	7314151831271	5	26,36	326
38-20	7314151831288	2	33,29	326
38-24	7314151831295	1	41,60	326
38-8	7314151831257	5	16,63	326
380-10	7314150133178	1	46,49	271
380-14	7314150133185	1	61,80	271
380-18	7314150133192	1	88,28	271
380-24	7314150133208	1	147,08	271
380-36	7314150133215	1	284,48	271
380-48	7314150133222	1	418,87	271
3802-300-25-1.25-10	7311518111229	10	12,25	20
3802-300-25-1.25-14	7311518111236	10	12,30	20
3802-300-25-1.25-6	7311518143299	10	12,25	20
3802-300-32-1.60-10	7311518111274	10	17,92	20
3802-300-32-1.60-6	7311518111298	10	17,66	20
3802-350-25-1.25-10	7311518111335	10	14,39	20
3802-350-25-1.25-14	7311518111342	10	14,39	20
3802-350-25-1.25-6	7311518111359	10	14,39	20
3802-350-32-1.60-10	7311518111397	10	18,97	20
3802-350-32-1.60-14	7311518111403	10	18,97	20
3802-350-32-1.60-4	7311518111410	10	18,97	20
3802-350-32-1.60-6	7311518111427	10	18,97	20
3802-350-32-1.60-8	7311518140908	10	18,97	20
3802-400-25-1.25-10	7311518111496	10	18,34	20
3802-400-25-1.25-14	7311518111502	10	18,34	20
3802-400-25-1.25-6	7311518111519	10	18,34	20
3802-400-32-1.60-10	7311518111557	10	23,95	20
3802-400-32-1.60-14	7311518111564	10	23,95	20
3802-400-32-1.60-4	7311518111571	10	23,95	20
3802-400-32-1.60-6	7311518111588	10	23,95	20
3802-400-32-1.60-8	7311518111595	10	23,95	20
3802-400-38-2.00-10	7311518111649	10	31,98	20
3802-400-38-2.00-4	7311518111656	10	31,98	20
3802-400-38-2.00-6	7311518111663	10	31,98	20
3802-425-32-1.60-10	7311518111694	10	28,92	20
3802-425-32-1.60-6	7311518111700	10	28,42	20
3802-450-32-1.60-10	7311518111731	10	29,93	20
3802-450-32-1.60-14	7311518111748	10	29,93	20
3802-450-32-1.60-4	7311518111755	10	29,93	20
3802-450-32-1.60-6	7311518111762	10	29,93	20
3802-450-38-2.00-10	7311518111816	10	40,15	20
3802-450-38-2.00-10-KA	7311518111823	10	40,15	20
3802-450-38-2.00-4	7311518111830	10	40,15	20
3802-450-38-2.00-4-KA	7311518111847	10	40,15	20
3802-450-38-2.00-6	7311518111854	10	40,15	20
3802-450-38-2.00-6-KA	7311518111861	10	40,15	20
3802-450-38-2.00-8	7311518111878	10	40,15	20
3802-450-38-2.00-8-KA	7311518111885	10	40,15	20



3802-475-38-2.00-8	7311518113117	10	42,96	20
3802-500-38-2.00-10	7311518111953	10	47,15	20
3802-500-38-2.00-4	7311518111960	10	47,15	20
3802-500-38-2.00-6	7311518111977	10	47,15	20
3802-500-38-2.00-8	7311518113070	10	47,15	20
3802-500-45-2.25-10	7311518111984	10	66,42	20
3802-500-50-2.50-4	7311518112028	10	71,12	20
3802-500-50-2.50-4-KA	7311518112035	10	71,12	20
3802-500-50-2.50-6	7311518112042	10	71,12	20
3802-500-50-2.50-6-KA	7311518112059	10	71,12	20
3802-525-38-2.00-10	7311518112073	10	49,53	20
3802-525-38-2.00-6	7311518112097	10	49,06	20
3802-525-38-2.00-8	7311518112103	10	43,92	20
3802-550-38-2.00-6	7311518112158	10	46,15	20
3802-550-50-2.50-10	7311518112196	10	80,18	20
3802-550-50-2.50-4	7311518112202	10	78,21	20
3802-550-50-2.50-4-KA	7311518112219	10	78,60	20
3802-550-50-2.50-6	7311518112226	10	78,60	20
3802-550-50-2.50-8	7311518112240	5	80,18	20
3802-550-50-2.50-8-KA	7311518113315	10	78,60	20
3802-575-50-2.50-3-KA	7311518112301	10	82,17	20
3802-575-50-2.50-4	7311518112318	10	82,17	20
3802-575-50-2.50-4-KA	7311518112325	10	82,17	20
3802-575-50-2.50-6	7311518112332	10	82,17	20
3802-575-50-2.50-6-KA	7311518112349	10	82,17	21
3802-600-50-2.50-4	7311518112417	10	87,53	20
3802-600-50-2.50-6	7311518112431	10	87,53	20
3802-600-50-2.50-8	7311518112455	10	87,53	20
3802-650-50-2.50-4	7311518112509	5	97,34	20
3802-650-50-2.50-4-KA	7311518112523	5	97,34	21
3802-650-50-2.50-6	7311518112530	5	97,34	20
3802-650-50-2.50-6-KA	7311518112554	5	88,85	21
3802-700-50-2.50-2-KA	7311518112578	5	105,96	21
3802-700-50-2.50-3	7311518112585	5	93,51	20
3802-700-50-2.50-4	7311518112608	5	106,40	20
3802-700-50-2.50-4-KA	7311518112615	5	106,40	21
3802-700-50-2.50-6	7311518112622	5	106,40	20
3802-700-50-2.50-6-KA	7311518112639	5	106,40	21
3802-750-50-2.50-4	7311518112660	5	124,10	20
3802-750-50-2.50-6	7311518112677	5	113,34	20
3806-600-32	7311518018092	10	26,94	545
3809-300-25-1.25-10	7311518113711	10	11,03	19
3809-300-25-1.25-14	7311518113728	10	11,09	19
3809-300-32-1.60-10	7311518113735	10	15,90	19
3809-300-32-1.60-6	7311518113742	10	15,78	19
3809-350-25-1.25-10	7311518113759	10	12,88	19
3809-350-25-1.25-14	7311518113766	10	12,88	19
3809-350-25-1.25-6	7311518113773	10	12,88	19
3809-350-32-1.60-10	7311518113780	10	16,97	19
3809-350-32-1.60-14	7311518113797	10	16,97	19
3809-350-32-1.60-4	7311518113803	10	16,97	19
3809-350-32-1.60-6	7311518113810	10	16,97	19
3809-350-32-1.60-8	7311518113827	10	16,97	19
3809-350-32-2.00-10	7311518113834	10	22,74	19
3809-350-32-2.00-4	7311518113841	10	22,74	19
3809-350-32-2.00-6	7311518113858	10	22,74	19
3809-350-38-2.00-10	7311518113865	10	28,49	19
3809-350-38-2.00-6	7311518113889	10	28,49	19
3809-400-25-1.25-10	7311518178666	10	16,39	19
3809-400-32-1.60-10	7311518113896	10	21,57	19
3809-400-32-1.60-14	7311518113902	10	21,57	19
3809-400-32-1.60-4	7311518113919	10	21,57	19
3809-400-32-1.60-6	7311518113933	10	21,57	19
3809-400-32-1.60-8	7311518113940	10	21,57	19
3809-400-32-2.00-10	7311518113957	10	25,30	19
3809-400-32-2.00-4	7311518113964	10	25,30	19
3809-400-32-2.00-6	7311518113971	10	25,30	19
3809-400-32-2.00-6-KA	7311518158248	10	25,33	20
3809-400-32-2.00-8	7311518114152	10	25,80	19
3809-400-38-2.00-10	7311518113988	10	28,84	19
3809-400-38-2.00-4	7311518113995	10	28,84	19
3809-400-38-2.00-6	7311518114008	10	28,84	19
3809-425-32-1.60-10	7311518114015	10	28,84	19
3809-425-32-1.60-6	7311518197759	10	25,47	19
3809-450-32-1.60-10	7311518114022	10	26,94	19
3809-450-32-1.60-14	7311518114039	10	26,94	19
3809-450-32-1.60-4	7311518114046	10	26,94	19
3809-450-32-1.60-6	7311518114053	10	26,94	19
3809-450-32-2.00-10	7311518114060	10	31,75	19
3809-450-32-2.00-4	7311518114077	10	31,75	19
3809-450-32-2.00-6	7311518114084	10	31,75	19
3809-450-38-2.00-10	7311518114091	10	36,11	19
3809-450-38-2.00-10-KA	7311518114107	10	36,11	20
3809-450-38-2.00-4	7311518114114	10	36,11	19
3809-450-38-2.00-4-KA	7311518114121	10	36,11	20
3809-450-38-2.00-6	7311518114138	10	36,11	19
3809-450-38-2.00-6-KA	7311518114145	10	36,11	20
3809-450-38-2.00-8	7311518114176	10	36,11	19
3809-450-45-2.25-4	7311518114206	10	45,24	19
3809-450-45-2.25-6	7311518114213	10	45,24	19
3809-475-45-2.25-6	7311518114237	10	52,27	19
3809-500-38-2.00-10	7311518114244	10	42,19	19
3809-500-38-2.00-4	7311518114251	10	42,19	19
3809-500-38-2.00-6	7311518114268	10	42,19	19
3809-500-45-2.25-4	7311518114275	10	54,04	19
3809-500-45-2.25-6	7311518114299	10	54,04	19

\* Hasta agotar existencias



3809-500-45-2.25-6-KA	7311518114305	10	54,04	20
3809-500-50-2.50-4	7311518114312	10	63,87	19
3809-500-50-2.50-4-KA	7311518114329	10	63,87	20
3809-500-50-2.50-6	7311518114336	10	63,87	19
3809-500-50-2.50-6-KA	7311518114343	10	63,87	20
3809-500-50-2.50-8	7311518114350	10	64,82	19
3809-525-38-2.00-10	7311518114367	10	44,09	19
3809-525-38-2.00-6	7311518114374	10	44,09	19
3809-525-45-2.25-4	7311518114381	10	56,50	19
3809-525-45-2.25-6	7311518114398	10	56,50	19
3809-550-45-2.25-4	7311518114411	10	59,42	19
3809-550-45-2.25-6	7311518114428	10	59,42	19
3809-550-50-2.50-4	7311518114435	10	70,81	19
3809-550-50-2.50-4-KA	7311518114442	10	70,81	20
3809-550-50-2.50-6	7311518114459	10	70,81	19
3809-550-50-2.50-6-KA	7311518114466	10	70,81	20
3809-575-45-2.25-4	7311518114473	10	64,73	19
3809-575-50-2.50-10-KA	7311518114497	10	73,84	20
3809-575-50-2.50-3	7311518114602	10	73,84	19
3809-575-50-2.50-3-KA	7311518114503	10	73,84	20
3809-575-50-2.50-4	7311518114510	10	73,84	19
3809-575-50-2.50-4-KA	7311518114527	10	73,84	20
3809-575-50-2.50-6	7311518114534	10	73,84	19
3809-575-50-2.50-6-KA	7311518114541	10	73,84	20
3809-600-38-2.00-6	7311518227579	10	52,49	19
3809-600-45-2.25-4	7311518172275	10	64,94	19
3809-600-45-2.25-6	7311518114558	10	64,94	19
3809-600-50-2.50-3	7311518114565	10	78,54	19
3809-600-50-2.50-4	7311518114572	10	78,54	19
3809-600-50-2.50-4-KA	7311518114589	10	78,54	20
3809-600-50-2.50-6	7311518114596	10	78,54	19
3809-600-50-2.50-6-KA	7311518114626	10	78,54	20
3809-650-50-2.50-3-KA	7311518114640	5	87,45	20
3809-650-50-2.50-4	7311518114657	5	87,45	19
3809-650-50-2.50-4-KA	7311518114664	5	87,45	20
3809-650-50-2.50-6	7311518114671	5	87,45	19
3809-650-50-2.50-6-KA	7311518114688	5	87,45	20
3809-700-50-2.50-3-KA	7311518114695	5	95,54	20
3809-700-50-2.50-4	7311518114701	5	95,54	19
3809-700-50-2.50-4-KA	7311518114718	5	95,54	20
3809-700-50-2.50-6	7311518114725	5	95,54	19
3809-700-50-2.50-6-KA	7311518114732	5	95,54	20
3809-750-50-2.50-4	7311518114749	5	111,50	19
3809-750-50-2.50-6	7311518234409	5	111,50	19
3815-200-2.0-32-1-03BW	7311518160258	1	85,44	18
3815-200-2.0-32-1-04BW	7311518160241	1	106,80	18
3815-225-2.0-32-1-03BW	7311518160319	1	129,36	18
3815-225-2.0-32-1-04BW	7311518158347	1	129,36	18
3815-225-2.0-32-1-05BW	7311518160302	1	129,36	18
3815-225-2.0-32-1-06C	7311518160296	1	129,36	18
3815-250-2.0-32-1-03BW	7311518160586	1	141,91	18
3815-250-2.0-32-1-04BW	7311518160579	1	141,91	18
3815-250-2.0-32-1-05BW	7311518158354	1	141,91	18
3815-250-2.0-32-1-06C	7311518160362	1	141,91	18
3815-250-2.0-40-2-03BW	7311518160540	1	141,91	18
3815-250-2.0-40-2-04BW	7311518174446	1	141,91	18
3815-250-2.0-40-2-05BW	7311518160333	1	141,91	18
3815-275-2.5-32-1-04BW	7311518160593	1	196,55	18
3815-275-2.5-32-1-05BW	7311518158361	1	196,55	18
3815-275-2.5-32-1-06C	7311518174590	1	196,55	18
3815-275-2.5-32-1-08C	7311518174583	1	196,55	18
3815-275-2.5-40-2-03BW	7311518176433	1	196,55	18
3815-275-2.5-40-2-04BW	7311518160623	1	196,55	18
3815-275-2.5-40-2-05BW	7311518158378	1	196,55	18
3815-275-2.5-40-2-06C	7311518160616	1	196,55	18
3815-275-2.5-40-2-08C	7311518160609	1	196,55	18
3815-300-2.5-32-1-04BW	7311518160630	1	242,34	18
3815-300-2.5-32-1-05BW	7311518158385	1	242,34	18
3815-300-2.5-32-1-05C	7311518174699	1	242,34	18
3815-300-2.5-32-1-06C	7311518174705	1	242,34	18
3815-300-2.5-32-1-08C	7311518174712	1	242,34	18
3815-315-2.5-32-1-04BW	7311518160210	1	292,42	18
3815-315-2.5-32-1-05BW	7311518160203	1	292,42	18
3815-315-2.5-32-1-06C	7311518160197	1	292,42	18
3815-315-2.5-32-1-08C	7311518160401	1</		



# 3830-114-VIP



3830-114-VIP	7311518042073	4	57,25	130
3830-121-C	7311518225643	1	63,75	130
3830-121-VIP	7311518042080	1	63,75	130
3830-127-C	7311518225650	1	69,60	130
3830-127-VIP	7311518042097	1	69,60	130
3830-133-C	7311518228545	1	74,80	130
3830-133-VIP	7311518042103	1	74,80	130
3830-14-C	7311518228347	1	12,23	130
3830-14-VIP	7311518041618	6	12,23	130
3830-140-C	7311518228552	1	80,00	130
3830-140-VIP	7311518042110	1	80,00	130
3830-146-C	7311518228569	1	83,25	130
3830-146-VIP	7311518042127	1	83,25	130
3830-152-C	7311518225667	1	91,06	130
3830-152-VIP	7311518042134	1	91,06	130
3830-16-C	7311518225353	1	12,23	130
3830-16-VIP	7311518041625	6	12,23	130
3830-168	7311518040659	1	118,29	130
3830-17-C	7311518228354	1	12,23	130
3830-17-VIP	7311518041632	6	12,23	130
3830-177-HIGH	7311518101329	1	162,84	130
3830-19-4P	7314150428557	1	18,05	130
3830-19-C	7311518225360	1	12,23	130
3830-19-VIP	7311518041649	6	12,23	130
3830-20-4P	7314150428601	1	19,23	130
3830-20-C	7311518225377	1	12,23	130
3830-20-VIP	7311518041656	6	12,23	130
3830-21-C	7311518228361	1	12,23	130
3830-21-VIP	7311518041663	6	12,23	130
3830-210	7311518040666	1	177,44	130
3830-22-4P	7314150428649	1	31,90	130
3830-22-C	7311518225384	1	12,23	130
3830-22-VIP	7311518041670	6	12,23	130
3830-24-C	7311518228378	1	12,23	130
3830-24-VIP	7311518041687	6	12,23	130
3830-25-4P	7314150428663	1	35,15	130
3830-25-C	7311518225391	1	12,35	130
3830-25-VIP	7311518041694	6	12,35	130
3830-27-4P	7314150428670	1	33,42	130
3830-27-C	7311518225407	1	13,01	130
3830-27-VIP	7311518041700	6	13,01	130
3830-29-4P	7314150428922	1	33,70	130
3830-29-C	7311518225414	1	13,01	130
3830-29-VIP	7311518041717	6	13,01	130
3830-30-4P	7314150433483	1	33,99	130
3830-30-C	7311518225421	1	13,01	130
3830-30-VIP	7311518041724	6	13,01	130
3830-32-4P	7314150428687	1	36,09	130
3830-32-C	7311518225438	1	13,01	130
3830-32-VIP	7311518041731	6	13,01	130
3830-33-C	7311518228385	1	13,01	130
3830-33-VIP	7311518041748	6	13,01	130
3830-35-4P	7314150428700	1	36,89	130
3830-35-C	7311518225445	1	14,71	130
3830-35-VIP	7311518041755	6	14,71	130
3830-37-C	7311518228392	1	14,71	130
3830-37-VIP	7311518041762	6	14,71	130
3830-38-C	7311518225452	1	14,71	130
3830-38-VIP	7311518041779	6	14,71	130
3830-40-C	7311518228408	1	14,71	130
3830-40-VIP	7311518041786	6	14,71	130
3830-41-C	7311518225469	1	14,71	130
3830-41-VIP	7311518041793	6	14,71	130
3830-43-C	7311518228415	1	14,71	130
3830-43-VIP	7311518041809	6	14,71	130
3830-44-C	7311518225476	1	16,79	130
3830-44-VIP	7311518041816	6	16,79	130
3830-46-C	7311518228422	1	16,79	130
3830-46-VIP	7311518041823	6	16,79	130
3830-48-C	7311518225483	1	16,79	130
3830-48-VIP	7311518041830	6	16,79	130
3830-50-C	7311518260873	1	16,79	130
3830-50-VIP	7311518260866	6	16,79	130
3830-51-C	7311518225490	1	16,79	130
3830-51-VIP	7311518041847	6	16,79	130
3830-52-C	7311518228439	1	20,29	130
3830-52-VIP	7311518041854	4	20,29	130
3830-54-C	7311518225506	1	20,29	130
3830-54-VIP	7311518041861	4	20,29	130
3830-55-C	7311518270919	1	20,29	130
3830-55-VIP	7311518270902	4	20,29	130
3830-56-C	7311518228446	1	20,29	130
3830-56-VIP	7311518152703	4	20,29	130
3830-57-C	7311518225513	1	20,29	130
3830-57-VIP	7311518041878	4	20,29	130
3830-59-C	7311518228453	1	20,29	130
3830-59-VIP	7311518041885	4	20,29	130
3830-60-C	7311518225520	1	20,29	130
3830-60-VIP	7311518041892	4	20,29	130
3830-62-VIP	7311518234645	4	22,09	130
3830-64-C	7311518225537	1	22,38	130
3830-64-VIP	7311518041908	4	22,38	130
3830-65-C	7311518228460	1	22,38	130
3830-65-VIP	7311518041915	4	22,38	130
3830-67-C	7311518225544	1	22,38	130
3830-67-VIP	7311518041922	4	22,38	130



3830-68-C	7311518228477	1	22,38	130
3830-68-VIP	7311518196530	4	22,38	130
3830-70-C	7311518225551	1	22,38	130
3830-70-VIP	7311518041939	4	22,38	130
3830-73-C	7311518228484	1	22,38	130
3830-73-VIP	7311518041946	4	22,38	130
3830-76-C	7311518225568	1	25,37	130
3830-76-VIP	7311518041953	4	25,37	130
3830-79-C	7311518228491	1	25,37	130
3830-79-VIP	7311518041960	4	25,37	130
3830-83-C	7311518225575	1	25,37	130
3830-83-VIP	7311518041977	4	25,37	130
3830-86-C	7311518228507	1	25,37	130
3830-86-VIP	7311518041984	4	25,37	130
3830-89-C	7311518225582	1	25,37	130
3830-89-VIP	7311518041991	4	25,37	130
3830-92-C	7311518225599	1	29,40	130
3830-92-VIP	7311518042004	4	29,40	130
3830-95-C	7311518225605	1	31,87	130
3830-95-VIP	7311518042011	4	31,87	130
3830-98-C	7311518228514	1	33,31	130
3830-98-VIP	7311518042028	4	33,31	130
3832-102	7311518558567	4	62,90	137
3832-102-C	7314150474394	1	73,69	137
3832-105	7311518558581	4	67,39	137
3832-108	7311518558604	4	79,02	137
3832-111	7311518558611	4	91,39	137
3832-114	7311518558628	4	101,50	137
3832-114-C	7314150474424	1	118,87	137
3832-121	7311518558642	1	112,74	137
3832-127	7311518558666	1	123,98	137
3832-127-C	7314150474431	1	131,62	137
3832-133	7311518558673	1	134,47	137
3832-14	7311518557744	6	20,60	137
3832-140	7311518558680	1	145,70	137
3832-146	7311518558697	1	153,17	137
3832-152	7311518558703	1	166,65	137
3832-16	7311518557768	6	20,60	137
3832-16-C	7314150474448	1	20,60	137
3832-17	7311518557782	6	20,60	137
3832-19	7311518557805	6	20,60	137
3832-19-C	7314150474455	1	20,60	137
3832-20	7311518557812	6	20,60	137
3832-20-C	7314150474462	1	20,60	137
3832-21	7311518557829	6	20,60	137
3832-22	7311518557843	6	20,60	137
3832-22-C	7314150474479	1	20,60	137
3832-24	7311518557867	6	20,60	137
3832-24-C	7314150479054	1	20,60	137
3832-25	7311518557881	6	21,72	137
3832-25-C	7314150474486	1	21,73	137
3832-27	7311518557904	6	23,22	137
3832-29	7311518557928	6	23,22	137
3832-29-C	7314150474493	1	23,22	137
3832-30	7311518557942	6	23,22	137
3832-30-C	7314150479061	1	23,22	137
3832-32	7311518557966	6	23,22	137
3832-32-C	7314150474509	1	23,22	137
3832-33	7311518557980	6	23,22	137
3832-35	7311518558000	6	25,83	137
3832-35-C	7314150474516	1	25,83	137
3832-37	7311518558024	6	25,83	137
3832-38	7311518558048	6	25,83	137
3832-38-C	7314150474523	1	25,83	137
3832-40	7311518558062	6	25,83	137
3832-41	7311518558086	6	25,83	137
3832-41-C	7314150474530	1	25,83	137
3832-43	7311518558109	6	25,83	137
3832-44	7311518558123	6	29,96	137
3832-44-C	7314150474547	1	29,96	137
3832-46	7311518558147	6	29,96	137
3832-46-C	7314150479078	1	29,96	137
3832-48	7311518558161	6	29,96	137
3832-48-C	7314150474554	1	29,96	137
3832-51	7311518558185	6	29,96	137
3832-51-C	7314150474561	1	29,96	137
3832-52	7311518558208	4	36,34	137
3832-54	7311518558222	4	36,34	137
3832-54-C	7314150474578	1	36,34	137
3832-56	7311518558239	4	36,34	137
3832-57	7311518558246	4	36,34	137
3832-57-C	7314150474585	1	36,34	137
3832-59	7311518558260	4	36,34	137
3832-60	7311518558284	4	36,34	137
3832-60-C	7314150474615	1	36,34	137
3832-64	7311518558307	4	40,07	137
3832-64-C	7314150474622	1	40,08	137
3832-65	7311518558321	4	40,07	137
3832-67	7311518558345	4	40,07	137
3832-68	7311518558352	4	40,07	137
3832-70	7311518558369	4	40,07	137
3832-73	7311518558383	4	40,07	137
3832-73-C	7314150474639	1	40,08	137
3832-76	7311518558406	4	44,58	137
3832-76-C	7314150474646	1	44,58	137
3832-79	7311518558420	4	44,58	137



3832-83	7311518558444	4	44,58	137
3832-83-C	7314150474653	1	44,58	137
3832-86	7311518558468	4	44,58	137
3832-86-C	7314150474660	1	44,58	137
3832-89	7311518558482	4	44,58	137
3832-92	7311518558505	4	51,68	137
3832-92-C	7314150474677	1	51,68	137
3832-95	7311518558529	4	56,56	137
3832-98	7311518558543	4	59,93	137
3832-SET-164-ES	7314150487349	1	394,87	138
3832-SET-84-ES	7314150498932	1	238,70	138
3833-102-C	7314150263899	1	33,06	135
3833-105-C	7314150263905	1	33,37	135
3833-108-C	7314150263912	1	33,52	135
3833-109-C	7314150263929	1	36,50	135
3833-111-C	7314150263936	1	33,76	135
3833-114-C	7314150263943	1	36,59	135
3833-121-C	7314150263950	1	37,04	135
3833-127-C	7314150263967	1	39,05	135
3833-133-C	7314150401581	1	39,98	135
3833-140-C	7314150263974	1	40,62	135
3833-152-C	7314150263981	1	43,68	135
3833-159-C	7314150263998	1	50,07	135
3833-168	7314150413546	1	55,98	135
3833-177	7314150413539	1	59,98	135
3833-19-C	7314150263561	1	13,62	135
3833-20-C	7314150263578	1	13,45	135
3833-210	7314150413522	1	69,57	135
3833-22-C	7314150263585	1	13,59	135
3833-225	7314150413515	1	73,11	135
3833-25-C	7314150263592	1	14,02	135
3833-27-C	7314150263608	1	14,63	135
3833-29-C	7314150263615	1	15,46	135
3833-30-C	7314150263622	1	15,27	135
3833-32-C	7314150263639	1	15,57	135
3833-35-C	7314150263646	1	17,48	135
3833-38-C	7314150263653	1	17,48	135
3833-40-C	7314150263660	1	17,79	135
3833-41-C	7314150263677	1	17,79	135
3833-44-C	7314150263684	1	20,92	135
3833-48-C	7314150263691	1	20,92	135
3833-51-C	7314150263707	1	21,43	135
3833-54-C	7314150263714	1	23,22	135
3833-56-C	7314150314676	1	24,18	135
3833-57-C	7314150263721	1	24,18	135
3833-60-C	7314150263738	1	24,18	135
3833-62-C	7314150314683	1	24,18	135
3833-64-C	7314150263745	1	24,32	135
3833-65-C	7314150263752	1	24,32	135
3833-67-C	7314150263769	1	24,32	135
3833-68-C	7314150263776	1	24,58	135
3833-70-C	7314150263783	1	24,77	135
3833-71-C	7314150314690	1	24,77	135
3833-73-C	7314150263790	1	24,77	135
3833-74-C	7314150314706	1	24,77	135
3833-76-C	7314150263806	1	25,69	135
3833-77-C	7314150263813	1	28,20	135
3833-78-C	7314150314713	1	28,20	135
3833-79-C	7314150263820	1	28,20	135
3833-83-C	7314150263837	1	28,75	135
3833-86-C	7314150263844	1	28,95	135
3833-89-C	7314150263851	1	29,09	135
3833-92-C	7314150263868	1	29,92	135
3833-95-C	7314150263875	1	30,78	135
3833-98-C	7314150263882	1	31,30	135
3833-PROMO-42	7314150464951	1	140,12	135
3833-SET-101	7314150315383	1	320,87	135
3833-SET-201	7314150315406	1	364,48	135
3833-SET-202	7314150315420	1	359,39	135
3833-SET-203	7314150315444	1	359,39	136
3833-SET-204	7314150315468	1	323,87	136
3833-SET-205	7314150330874	1	271,36	136
3833-SET-207	7314150330898	1	363,88	136
3833-SET-208	7314150330904	1	371,34	136
3833-SET-301	7314150315376	1	344,22	136
3833-SET-302	7314150315390	1	224,94	137
3833-SET-303	7314150315413	1	288,84	137
3833-SET-304	7314150315437	1	357,64	137
3834-ADP	7311518454425	1	6,61	139
3834-ARBR-11152	7311518015596	1	25,47	139
3834-ARBR-11152-C	7311518225698	1	26,76	139
3834-ARBR-11152QC	7311518167967	1	21,72	139
3834-ARBR-11152QC-C	7311518225711	1	22,82	139
3834-ARBR-1130	7311518015572	4	14,04	139
3834-ARBR-1130-C	7311518228583	1	14,74	139
3834-ARBR-16152	7311518015602	1	25,47	139
3834-ARBR-16152QC	7311518453152	1	23,80	139
3834-ARBR-630	7311518015558	1	12,16	139
3834-ARBR-630-C	7311518228576	1	12,76	139
3834-ARBR-730	7311518167974	1	9,72	139
3834-ARBR-730-C	7311518225674	1	10,23	139
3834-ARBR-9100	7311518015589	1	25,47	139
3834-ARBR-9100-C	7311518228590	1	26,76	139
3834-ARBR-9100EL	7314150265077	1	43,87	138
3834-ARBR-9100ESM	7314150390458	1	44,55	138
3834-ARBR-9100QC	7311518249830	1	21,72	139

\* Hasta agotar existencias



3834-ARBR-9100QC-C	7311518225704	1	23,05	139
3834-ARBR-930	7311518015565	1	12,16	139
3834-ARBR-930-C	7311518225681	1	12,76	139
3834-ARBR-930EL	7314150265053	1	43,12	138
3834-ARBR-930ESM	7314150390465	1	42,50	138
3834-ARBR-930QC-C	7314150472239	1	15,55	139
3834-ARBR-SD152QC	7311518203825	1	26,98	139
3834-ARBR-SD30	7311518203818	1	14,98	139
3834-CP-20/25	7314150312092	1	64,77	130
3834-DRL	7311518234638	1	5,82	139
3834-DRL-CT	7311518953201	1	16,87	139
3834-DRL-EL	7314150265114	1	9,68	138
3834-DRL-ES	7314150265091	1	9,28	138
3834-DRL-HSS-ES	7314150339396	1	16,36	138
3834-DRL-L	7314150265138	1	9,41	139
3834-ES	7311518454418	1	2,20	139
3834-EXT-1	7311518040673	1	21,42	139
3834-EXT-2	7311518168070	1	21,42	139
3834-M6X29-SET	7314150383450	1	2,75	140
3834-M8X10-SET	7314150383429	1	1,94	140
3834-M8X5-SET	7314150383443	1	1,72	140
3834-M8X6-SET	7314150383436	1	1,82	140
3834-PROMO-122	7314150432059	1	113,30	131
3834-PROMO-122-76	7314150459193	1	123,68	131
3834-PROMO-82	7314150432042	1	93,93	131
3834-SET-103	7314150134908	1	148,43	134
3834-SET-152	7314150255658	1	264,46	134
3834-SET-42	7311518241988	1	154,40	131
3834-SET-53	7314150127153	1	224,92	131
3834-SET-61	7311518266431	1	188,65	132
3834-SET-62	7311518228040	1	126,13	132
3834-SET-62-16/50	7311518258887	1	120,55	132
3834-SET-65-16/51	7311518159900	1	140,64	132
3834-SET-65-22/64	7311518159917	1	156,51	132
3834-SET-72	7311518044992	1	168,14	132
3834-SET-72-35/83	7314150444229	1	128,94	131
3834-SET-73	7311518254339	1	209,04	133
3834-SET-73-22/68	7314150134809	1	155,97	133
3834-SET-77	7314150235919	1	206,31	133
3834-SET-84-ES	7314150470587	1	126,29	133
3834-SET-86	7311518224295	1	276,86	133
3834-SET-87	7311518181772	1	193,51	133
3834-SET-92	7311518044985	1	193,52	134
3834-SET-93	7314150414741	1	168,00	134
3834-SET-94	7311518166458	1	179,46	134
3834-SET-95	7311518159894	1	189,74	134
3834-UPSIZO	7314150344567	1	4,56	139
3835-SET-64	7314150423309	1	260,51	138
3835-SET-711	7314150465835	1	273,52	138
384-5T	7311518159795	4	19,37	616
384-6T	7311518002039	4	19,37	616
3845-18-10P	7311518101602	1	41,83	141
3845-24-10P	7311518101619	1	41,83	141
3845-32-10P	7311518101626	1	41,83	141
385-6T	7311518002053	4	20,58	616
3851-10-0.6-10/14	7311518182717	1	9,25	12
3851-10-0.6-H-4	7311518282776	1	9,25	12
3851-10-0.6-H-6	7311518282806	1	9,25	12
3851-10-0.6-HA-4	7314150139309	1	9,25	12
3851-10-0.9-10/14	7311518182823	1	9,25	12
3851-10-0.9-H-4	7311518282851	1	9,25	12
3851-10-0.9-H-6	7311518282868	1	9,25	12
3851-10-0.9-R-14	7314150312399	1	9,25	12
3851-13-0.5-10/14	7311518282813	1	9,25	12
3851-13-0.5-14/18	7311518282790	1	9,25	12
3851-13-0.5-H-4	7311518292072	1	9,25	12
3851-13-0.5-R-10	7311518331306	1	9,25	12
3851-13-0.5-R-14	7311518331320	1	9,25	12
3851-13-0.5-R-18	7311518331344	1	9,25	12
3851-13-0.5-R-24	7311518282820	1	9,25	12
3851-13-0.6-10/14	7311518183271	1	9,25	12
3851-13-0.6-5/8	7311518183233	1	9,25	12
3851-13-0.6-6/10	7311518183240	1	9,25	12
3851-13-0.6-8/12	7311518185572	1	9,25	12
3851-13-0.6-H-3	7311518282769	1	9,25	12
3851-13-0.6-H-4	7311518282745	1	9,25	12
3851-13-0.6-H-6	7311518282738	1	9,25	12
3851-13-0.6-HA-4	7311518282752	1	9,25	12
3851-13-0.6-HA-6	7311518282561	1	9,25	12
3851-13-0.6-R-10	7311518183110	1	9,25	12
3851-13-0.6-R-14	7311518183158	1	9,25	12
3851-13-0.6-R-18	7311518183196	1	9,25	12
3851-13-0.9-10/14	7311518183868	1	9,25	12
3851-13-0.9-6/10	7311518183585	1	9,25	12
3851-13-0.9-H-3	7311518282936	1	9,25	12
3851-13-0.9-H-4	7311518282943	1	9,25	12
3851-13-0.9-H-6	7311518286125	1	9,25	12
3851-13-0.9-HA-4	7311518281052	1	9,25	12
3851-13-0.9-R-14	7311518182359	1	9,25	12
3851-13-0.9-R-6	7311518183301	1	9,25	12
3851-20-0.9-10/14	7311518282585	1	9,42	12
3851-20-0.9-4/6	7311518183905	1	9,42	12
3851-20-0.9-5/8	7311518183929	1	9,42	12
3851-20-0.9-6/10	7311518183936	1	9,42	12
3851-20-0.9-8/12	7311518282578	1	9,42	12
3851-20-0.9-H-3	7314150398515	1	9,42	12





# 3851-20-0.9-H-4



3851-20-0.9-H-4	7314150398294	1	9,42	12
3851-20-0.9-HA-3	7311518282646	1	9,42	12
3851-20-0.9-HA-4	7311518282653	1	9,42	12
3851-20-0.9-R-18	7311518332587	1	9,42	12
3851-27-0.9-10/14	7311518165475	1	9,58	13
3851-27-0.9-2/3	7311518126377	1	9,58	13
3851-27-0.9-3/4	7311518126384	1	9,58	13
3851-27-0.9-4/6	7311518126391	1	9,58	13
3851-27-0.9-5/8	7311518126407	1	9,58	13
3851-27-0.9-6/10	7311518126414	1	9,58	13
3851-27-0.9-8/12	7311518160692	1	9,58	13
3851-27-0.9-HA-3	7311518282684	1	9,58	12
3851-27-0.9-HA-4	7314150398317	1	9,58	12
3851-27-0.9-P-3	7311518157135	1	9,58	12
3851-27-0.9-P-4	7311518157661	1	9,58	12
3851-27-0.9-R-6	7311518126353	1	9,58	12
3851-34-1.1-2/3	7311518126476	1	14,08	13
3851-34-1.1-3/4	7311518126483	1	14,08	13
3851-34-1.1-4/6	7311518126490	1	14,08	13
3851-34-1.1-5/8	7311518126506	1	14,08	13
3851-34-1.1-6/10	7311518165505	1	14,08	13
3851-34-1.1-P-2	7311518157715	1	14,08	12
3851-34-1.1-P-3	7311518157753	1	14,08	12
3851-41-1.3-1.4/2	7311518211837	1	18,24	13
3851-41-1.3-2/3	7311518126568	1	18,24	13
3851-41-1.3-3/4	7311518126575	1	18,24	13
3851-41-1.3-4/6	7311518126582	1	18,24	13
3851-41-1.3-5/8	7311518262488	1	18,24	13
3851-54-1.3-1.4/2	7314150459360	1	20,84	13
3851-54-1.3-2/3	7311518163716	1	20,86	13
3851-54-1.3-3/4	7311518163723	1	23,41	13
3851-54-1.3-4/6	7311518168025	1	20,86	13
3851-54-1.6-1.4/2	7311518211431	1	20,86	13
3851-54-1.6-1/1.4	7311518188542	1	20,86	13
3851-54-1.6-2/3	7311518126636	1	20,86	13
3851-54-1.6-3/4	7311518126643	1	20,86	13
3851-54-1.6-4/6	7314150398539	1	20,86	13
3851-54-1.6-P-1.25	7311518158026	1	20,86	13
3851-6-0.6-10/14	7311518180652	1	8,92	12
3851-6-0.6-H-6	7311518282707	1	8,92	12
3851-6-0.9-10/14	7311518180768	1	8,92	12
3851-6-0.9-H-6	7311518282714	1	8,92	12
3851-67-1.6-7/1	7311518200909	1	36,13	13
3851-67-1.6-1.4/2	7314150273317	1	36,13	13
3851-67-1.6-1/1.4	7311518178840	1	36,13	13
3851-67-1.6-2/3	7311518335243	1	36,13	13
3851-67-1.6-3/4	7311518285997	1	36,13	13
3851-67-1.6-4/6	7311518194963	1	36,13	13
3851-80-1.6-7/1	7311518255367	1	54,27	13
3851-80-1.6-1.4/2	7311518255350	1	54,27	13
3851-80-1.6-1/1.4	7311518197377	1	54,27	13
3852-27-0.9-INS-3	7311518358204	1	13,79	18
3852-34-1.1-INS-3	7311518359188	1	14,85	18
3853-20-0.9-5/7-VS	7311518331689	1	10,34	14
3853-20-0.9-8/11-VS	7311518331702	1	10,34	14
3853-27-0.9-3/4	7311518285395	1	10,74	14
3853-27-0.9-4/6	7311518183998	1	10,74	14
3853-27-0.9-5/7-VS	7311518331115	1	10,74	14
3853-27-0.9-5/8	7311518202118	1	10,74	14
3853-27-0.9-8/11-VS	7311518331122	1	10,74	14
3853-34-1.1-2/3	7311518282875	1	13,30	14
3853-34-1.1-3/4	7311518184094	1	13,30	14
3853-34-1.1-4/6	7311518184087	1	13,30	14
3853-34-1.1-5/7-VS	7311518331726	1	13,30	14
3853-34-1.1-5/8	7311518202149	1	13,30	14
3853-34-1.1-8/11-VS	7311518331719	1	13,30	14
3853-41-1.3-2/3	7311518282882	1	20,60	14
3853-41-1.3-2/3-W	7314150370115	1	20,60	14
3853-41-1.3-2/3-WS	7314150415113	1	53,41	14
3853-41-1.3-3/4	7311518185770	1	20,60	14
3853-41-1.3-3/4-W	7311518338053	1	20,60	14
3853-41-1.3-3/4-WS	7314150415120	1	50,34	14
3853-41-1.3-4/6	7311518184100	1	20,60	14
3853-41-1.3-5/7-VS	7311518331733	1	20,60	14
3853-41-1.3-5/8	7311518202286	1	20,60	14
3853-54-1.3-3/4	7311518184124	1	25,30	14
3853-54-1.3-3/4-W	7314150352876	1	25,30	14
3853-54-1.3-5/8	7311518197568	1	25,30	14
3853-54-1.6-2/3	7311518282899	1	25,30	14
3853-54-1.6-2/3-W	7311518338077	1	25,30	14
3853-54-1.6-2/3-WS	7314150415151	1	58,85	14
3853-54-1.6-3/4	7311518216757	1	25,30	14
3853-54-1.6-3/4-W	7311518338091	1	25,30	14
3853-54-1.6-3/4-WS	7314150415168	1	55,07	14
3853-54-1.6-4/6	7311518222055	1	25,30	14
3853-67-1.6-2/3	7311518282905	1	35,95	14
3853-67-1.6-2/3-W	7311518338114	1	35,95	14
3853-67-1.6-2/3-WS	7314150415175	1	65,61	14
3853-67-1.6-3/4	7311518282912	1	35,95	14
3853-67-1.6-3/4-W	7311518338138	1	35,95	14
3853-67-1.6-3/4-WS	7314150415182	1	63,87	14
3853-67-1.6-5/8-W	7311518338152	1	35,95	14
3854-27-0.9-PHX-2/3	7314150440603	1	10,76	13
3854-27-0.9-PHX-3/4	7314150440610	1	10,76	13
3854-27-0.9-PHX-4/6	7314150440627	1	10,76	13
3854-27-0.9-PQ-3/4	7314150137480	1	15,01	13



3854-27-0.9-PQ-4/6	7314150197828	1	15,01	13
3854-34-1.1-PHX-1.4/2	7314150440634	1	15,07	13
3854-34-1.1-PHX-2/3	7314150440641	1	15,07	13
3854-34-1.1-PHX-3/4	7314150440658	1	15,07	13
3854-34-1.1-PHX-4/6	7314150440665	1	15,07	13
3854-34-1.1-PQ-2/3	7311518287276	1	17,09	13
3854-34-1.1-PQ-3/4	7314150135813	1	17,09	13
3854-34-1.1-PQ-4/6	7314150197835	1	17,09	13
3854-41-1.3-PHX-1.4/2	7314150440672	1	19,52	13
3854-41-1.3-PHX-2/3	7314150440689	1	19,52	13
3854-41-1.3-PHX-3/4	7314150440696	1	19,52	13
3854-41-1.3-PHX-4/6	7314150440702	1	19,52	13
3854-41-1.3-PQ-1.4/2	7314150129355	1	20,34	13
3854-41-1.3-PQ-2/3	7311518280604	1	20,34	13
3854-41-1.3-PQ-3/4	7311518282950	1	20,34	13
3854-41-1.3-PQ-4/6	7314150197842	1	20,34	13
3854-54-1.3-PHX-1.4/2	7314150440719	1	27,18	13
3854-54-1.3-PHX-2/3	7314150440733	1	27,18	13
3854-54-1.3-PHX-3/4	7314150440740	1	27,18	13
3854-54-1.6-PHX-7/1	7314150440757	1	30,79	13
3854-54-1.6-PHX-1.4/2	7314150440771	1	30,79	13
3854-54-1.6-PHX-1/1.4	7314150440764	1	30,79	13
3854-54-1.6-PHX-2/3	7314150440788	1	30,79	13
3854-54-1.6-PHX-3/4	7314150440795	1	30,79	13
3854-54-1.6-PQ-9/1.2	7314150133857	1	31,04	13
3854-54-1.6-PQ-1.4/2	7314150127092	1	31,04	13
3854-54-1.6-PQ-2/3	7311518265137	1	31,04	13
3854-54-1.6-PQ-3/4	7311518282929	1	31,04	13
3854-54-1.6-PQ-4/6	7311518330637	1	31,04	13
3854-67-1.6-PHX-7/1	7314150440801	1	38,67	13
3854-67-1.6-PHX-1.4/2	7314150440825	1	38,67	13
3854-67-1.6-PHX-1/1.4	7314150440818	1	38,67	13
3854-67-1.6-PHX-2/3	7314150440832	1	38,67	13
3854-67-1.6-PQ-9/1.2	7314150133888	1	40,30	13
3854-67-1.6-PQ-1.4/2	7314150133901	1	40,30	13
3854-67-1.6-PQ-2/3	7311518290160	1	40,30	13
3854-80-1.6-PHX-7/1	7314150440849	1	58,07	13
3854-80-1.6-PHX-1.4/2	7314150440863	1	58,07	13
3854-80-1.6-PHX-1/1.4	7314150440856	1	58,07	13
3854-80-1.6-PQ-9/1.2	7314150133895	1	59,60	13
3854-80-1.6-PQ-1.4/2	7314150215966	1	58,07	13
3857-13-0.6-EZ-L	7311518264789	1	10,10	12
3857-13-0.6-EZ-M	7311518264772	1	10,10	12
3857-13-0.6-EZ-M-3P1140	7314150321100	1	28,62	149
3857-13-0.6-EZ-M-3P690	7314150325641	1	28,62	149
3857-13-0.6-EZ-M-3P730	7314150325658	1	28,62	149
3857-13-0.6-EZ-M-3P835	7314150325665	1	28,62	149
3857-13-0.6-EZ-M-3P900	7314150321094	1	28,62	149
3857-13-0.6-EZ-S	7311518264765	1	10,10	12
3857-13-0.6-EZ-S-3P1140	7314150345731	1	28,62	149
3857-13-0.6-EZ-S-3P690	7314150345694	1	28,62	149
3857-13-0.6-EZ-S-3P730	7314150345700	1	28,62	149
3857-13-0.6-EZ-S-3P835	7314150345717	1	28,62	149
3857-13-0.6-EZ-S-3P900	7314150345724	1	28,62	149
3857-20-0.9-EZ-L	7311518264819	1	11,24	12
3857-20-0.9-EZ-M	7311518264802	1	11,24	12
3857-20-0.9-EZ-S	7311518264796	1	11,24	12
3857-27-0.9-EZ-L	7311518264840	1	12,80	12
3857-27-0.9-EZ-M	7311518264833	1	12,80	12
3857-27-0.9-EZ-S	7311518264826	1	12,80	12
3857-34-1.1-EZ-L	7311518264871	1	15,72	12
3857-34-1.1-EZ-M	7311518264864	1	15,72	12
3857-34-1.1-EZ-S	7311518264857	1	15,72	12
3858-34-1.1-PHX-1.4/2	7314150441198	1	15,97	14
3858-34-1.1-PHX-2/3	7314150441204	1	15,97	14
3858-34-1.1-PHX-3/4	7314150441211	1	15,97	14
3858-41-1.3-PHX-1.4/2	7314150441013	1	21,37	14
3858-41-1.3-PHX-2/3	7314150441020	1	21,37	14
3858-41-1.3-PHX-3/4	7314150441037	1	21,37	14
3858-41-1.3-PQ-1.4/2	7314150395583	1	26,40	14
3858-41-1.3-PQ-2/3	7314150395590	1	26,40	14
3858-41-1.3-PQ-3/4	7314150395606	1	26,40	14
3858-54-1.3-PHX-1.4/2	7314150441068	1	27,66	14
3858-54-1.3-PHX-2/3	7314150441044	1	27,66	14
3858-54-1.3-PHX-3/4	7314150441051	1	27,66	14
3858-54-1.6-PHX-7/1	7314150441075	1	27,66	14
3858-54-1.6-PHX-1.4/2	7314150441099	1	27,66	14
3858-54-1.6-PHX-1/1.4	7314150441082	1	27,66	14
3858-54-1.6-PHX-2/3	7314150441105	1	27,66	14
3858-54-1.6-PHX-3/4	7314150441112	1	27,66	14
3858-54-1.6-PQ-9/1.2	7314150395613	1	40,23	14
3858-54-1.6-PQ-1.4/2	7314150395620	1	40,23	14
3858-54-1.6-PQ-2/3	7314150395637	1	40,23	14
3858-67-1.6-PHX-7/1	7314150441129	1	37,72	14
3858-67-1.6-P				



3859-34-1.1-EZX-3/4	7314150517589	1	41,59	15
3859-34-1.1-EZX-4/6	7314150517596	1	44,98	15
3859-41-1.3-EZX-1.4/2	7314150517602	1	31,30	15
3859-41-1.3-EZX-2/3	7314150517619	1	35,33	15
3859-41-1.3-EZX-3/4	7314150517626	1	45,52	15
3859-41-1.3-EZX-4/6	7314150517633	1	47,64	15
3859-54-1.6-EZX-1.4/2	7314150517640	1	44,45	15
3859-54-1.6-EZX-1/1.25	7314150517657	1	40,42	15
3859-54-1.6-EZX-2/3	7314150517664	1	46,04	15
3859-54-1.6-EZX-3/4	7314150517671	1	49,44	15
3859-54-1.6-EZX-4/6	7314150517688	1	58,45	15
3859-67-1.6-EZX-7/1	7314150517695	1	40,63	15
3859-67-1.6-EZX-1.4/2	7314150517701	1	48,06	15
3859-67-1.6-EZX-1/1.25	7314150517718	1	44,03	15
3859-67-1.6-EZX-2/3	7314150517725	1	58,89	15
3859-80-1.6-EZX-7/1	7314150517732	1	42,76	15
3859-80-1.6-EZX-1.4/2	7314150517749	1	50,71	15
3859-80-1.6-EZX-1/1.25	7314150517756	1	79,57	15
386-6T	7311518152017	4	21,78	616
3860-100-1.1-TMC-1.4/2	731415033968	1	120,44	16
3860-27-0.9-TCA-3	7311518330750	1	72,81	17
3860-27-0.9-TCD-3	7314150413010	1	99,35	16
3860-27-0.9-TCD-3/4	7314150413027	1	94,18	16
3860-27-0.9-TCZ-3/4	7314150263493	1	92,14	17
3860-34-1.1-TCA-2/3	7311518330781	1	59,90	17
3860-34-1.1-TCA-3	7311518330774	1	79,16	17
3860-34-1.1-TCD-2/3	7314150413034	1	72,85	16
3860-34-1.1-TCD-3/4	7314150413041	1	103,99	16
3860-34-1.1-TCD-3/4-W	7314150413058	1	103,99	16
3860-34-1.1-TCZ-2/3	7311518330880	1	72,88	17
3860-34-1.1-TCZ-3/4	7311518330897	1	103,98	17
3860-41-1.3-TCA-1.4/2	7311518330620	1	54,36	17
3860-41-1.3-TCA-2/3	7311518330675	1	68,93	17
3860-41-1.3-TCD-1.4/2	7314150413065	1	65,84	16
3860-41-1.3-TCD-1.9/2.1	7314150413072	1	70,56	16
3860-41-1.3-TCD-2/3	7314150413089	1	73,49	16
3860-41-1.3-TCD-3/4	7314150413096	1	109,81	16
3860-41-1.3-TCZ-2/3	7311518330903	1	71,75	17
3860-41-1.3-TCZ-3/4	7311518330910	1	109,81	17
3860-41-1.3-TMC-1.4/2	7314150129379	1	100,02	16
3860-41-1.3-TMC-2/3	7311518330224	1	117,03	16
3860-54-1.3-TMC-1.4/2	7314150288748	1	118,42	16
3860-54-1.3-TMC-2/3	7311518335267	1	137,04	16
3860-54-1.6-TCA-8/1	7314150502998	1	76,22	17
3860-54-1.6-TCA-1.4/2	7311518330798	1	68,93	17
3860-54-1.6-TCA-1/1.25	7311518330934	1	56,02	17
3860-54-1.6-TCD-1.4/2	7314150413119	1	83,83	16
3860-54-1.6-TCD-1.9/2.1	7314150413133	1	68,40	16
3860-54-1.6-TCD-2/3	7314150413140	1	100,64	16
3860-54-1.6-TCD-3/4	7314150413157	1	139,75	16
3860-54-1.6-TMC-7/1	7314150263431	1	92,70	16
3860-54-1.6-TMC-1.4/2	7314150137978	1	110,02	16
3860-54-1.6-TMC-1.4/2S	7314150395316	1	122,23	17
3860-54-1.6-TMC-1/1.25	7314150154340	1	117,53	16
3860-54-1.6-TMC-1/1.25S	7314150395309	1	118,74	17
3860-54-1.6-TMC-2/3	7314150189366	1	151,06	16
3860-54-1.6-TMC-2/3S	7314150395323	1	133,87	17
3860-67-1.6-TCD-1.4/2	7314150413164	1	89,64	16
3860-67-1.6-TCD-1/1.25	7314150413171	1	63,27	16
3860-67-1.6-TMC-1.4/2	7314150137985	1	125,03	16
3860-67-1.6-TMC-1.4/2S	7314150395347	1	133,87	17
3860-67-1.6-TMC-1/1.25	7314150154364	1	130,03	16
3860-67-1.6-TMC-1/1.25S	7314150395330	1	128,05	17
3860-67-1.6-TMC-2/3	7314150189359	1	154,21	16
3860-80-1.1-TMC-1.4/2	7314150382767	1	116,67	16
3860-80-1.6-TCA-8/1	7314150353651	1	81,18	17
3860-80-1.6-TCD-5/0.8	7314150413188	1	96,68	16
3860-80-1.6-TMC-7/1	7314150154371	1	140,04	16
3860-80-1.6-TMC-1.4/2	7314150182992	1	153,79	16
3860-80-1.6-TMC-1/1.25	7314150182336	1	146,90	16
3860-80-1.6-TMC-2/3	7314150215959	1	155,64	16
3861-20-0.6-H-4	7311518331351	1	2,97	17
3861-27-0.9-H-1.33	7311518329716	1	3,94	17
3861-34-0.9-H-1.15	7311518258894	1	8,98	17
3861-34-1.1-H-1.15	7311518258900	1	8,98	17
3861-41-1.1-H-1.15	7314150129294	1	11,92	17
3861-54-1.1-H-1.15	7314150129270	1	13,47	17
3862-33-0.9-H-1.15	7314150320325	1	14,54	18
3862-33-1.1-H-1.15	7311518331269	1	14,54	18
3862-40-1.1-H-1.15	7311518331283	1	15,54	18
3868-27-0.9-TSS-3/4	7314150447633	1	90,11	15
3868-27-0.9-TSX-3/4	7311518329693	1	90,11	15
3868-34-1.1-TSS-2/3	7311518329266	1	73,35	15
3868-34-1.1-TSS-3/4	7314150447640	1	87,40	15
3868-34-1.1-TSX-2	7311518203016	1	59,05	15
3868-34-1.1-TSX-2/3	7311518255343	1	71,91	15
3868-34-1.1-TSX-3/4	7311518232375	1	88,67	15
3868-41-1.3-TSS-1.4/2	7311518243142	1	79,95	15
3868-41-1.3-TSS-2/3	7311518270643	1	79,10	15
3868-41-1.3-TSX-1.4/2	7311518214210	1	72,61	15
3868-41-1.3-TSX-1.6	7311518203092	1	63,11	15
3868-41-1.3-TSX-2	7311518203085	1	62,01	15
3868-41-1.3-TSX-2/3	7311518232382	1	77,12	15
3868-41-1.3-TSX-3/4	7311518232399	1	94,89	15
3868-54-1.3-TSX-1.4/2	7311518214876	1	94,22	15
3868-54-1.3-TSX-2/3	7314150416394	1	95,80	15

\* Hasta agotar existencias



3868-54-1.6-TSS-1.4/2	7311518243166	1	115,31	15
3868-54-1.6-TSS-1/1.25	7311518243173	1	117,41	15
3868-54-1.6-TSS-2/3	7311518280383	1	121,64	15
3868-54-1.6-TSX-1.4/2	7311518214869	1	104,92	15
3868-54-1.6-TSX-1.6	7311518203108	1	91,23	15
3868-54-1.6-TSX-1/1.25	7311518213114	1	95,95	15
3868-54-1.6-TSX-2/3	7311518232405	1	96,08	15
3868-54-1.6-TSX-3/4	7311518270360	1	96,08	15
3868-67-1.6-TSS-7/1	7311518274115	1	126,10	15
3868-67-1.6-TSS-1.4/2	7311518243197	1	134,21	15
3868-67-1.6-TSS-1/1.25	7311518243180	1	134,21	15
3868-67-1.6-TSS-2/3	7311518328825	1	134,21	15
3868-67-1.6-TSX-7/1	7311518212865	1	126,10	15
3868-67-1.6-TSX-1.4/2	7311518265496	1	134,21	15
3868-67-1.6-TSX-1/1.25	7311518213084	1	131,25	15
3868-67-1.6-TSX-2/3	7314150203536	1	134,21	15
3868-80-1.1-TSX-3/4	7311518330200	1	211,20	15
3868-80-1.6-TSS-7/1	7314150216253	1	134,21	15
3868-80-1.6-TSS-1.4/2	7314150203529	1	160,92	15
3868-80-1.6-TSS-2/3	7314150398553	1	186,06	15
3868-80-1.6-TSX-7/1	7311518212872	1	134,21	15
3868-80-1.6-TSX-1.4/2	7314150342167	1	133,28	15
3868-80-1.6-TSX-1/1.25	7314150277278	1	143,32	15
3868-80-1.6-TSX-2/3	7314150203543	1	186,06	15
3869-13-0.9-TS-3	7311518200589	1	55,61	15
3869-20-0.9-TS-3	7311518177300	1	57,50	15
3869-20-0.9-TS-4	7311518197742	1	83,89	15
3869-27-0.9-TS-3	7311518177348	1	57,50	15
3869-27-0.9-TS-4	7311518182595	1	83,89	15
3869-34-1.1-TS-2	7314150330508	1	36,33	15
3869-34-1.1-TS-3	7311518177355	1	61,27	15
3870-BRUSH-100-10	7311518269876	4	34,28	21
3870-BRUSH-100-10-HEX	7311518333935	4	34,28	21
3870-BRUSH-100-12	7311518269883	4	25,36	21
3870-BRUSH-100-13	7314150321131	4	34,28	21
3870-BRUSH-60-6	7311518279523	4	23,09	21
3870-BRUSH-80-10	7311518278311	4	26,78	21
3870-BRUSH-80-6	7311518269906	4	26,78	21
3870-BRUSH-80-8	7311518269890	4	26,78	21
3870-REFRACTOMETER	7311518192129	1	73,68	21
3870-TENSION METER	7311518145637	1	297,32	21
3870-WEDGE-3	7311518262747	1	4,66	21
3870-WHEEL	7314150398652	1	62,86	21
3875-BP2	7314150187744	10	131,64	460
3875-HB10*	7314150349777	1	9,15	459
3875-HB100	7314150289783	1	189,99	459
3875-HB30	7314150187720	1	94,00	459
3875-HB60	7314150187713	6	117,54	459
3875-LY10*	7314150315062	1	70,37	459
3875-LY2	7314150191260	8	40,43	458
3875-LY3	7314150191284	8	40,43	458
3875-LY600	731415051521	1	26,10	458
3875-LY70	7314150442751	1	25,62	458
3875-LY8*	7314150309689	1	59,10	458
3875-MHP6	7314150187812	1	93,52	460
3875-QL1	7314150191307	8	15,46	458
3875-QRL1	7314150194797	1	20,15	458
3875-RL1	7314150194780	1	70,11	458
3875-RL2	7314150312948	1	70,37	458
3875-SB70	7314150326839	1	260,36	460
3875-SL1	7314150220106	1	0,70	459
3875-WL1	7314150191291	8	26,39	458
3881-100-1.6-THS-7/1	7311518029617	1	78,07	16
3881-34-1.1-THQ-2/3	7311518265793	1	82,52	16
3881-41-1.3-THQ-1.4/2	7314150129447	1	83,61	16
3881-41-1.3-THQ-2/3	7314150129454	1	88,67	16
3881-41-1.3-THS-1.4/2	7311518273712	1	91,95	16
3881-54-1.6-THQ-1.4/2	7314150128860	1	110,46	16
3881-54-1.6-THQ-1/1.25	7314150342181	1	110,59	16
3881-54-1.6-THQ-2/3	7314150138739	1	110,48	16
3881-54-1.6-THS-1.4/2	7314150138784	1	121,49	16
3881-54-1.6-THS-1/1.25	7311518269050	1	121,49	16
3881-67-1.6-THQ-1.4/2	7314150120369	1	137,54	16
3881-67-1.6-THQ-1/1.25	7314150180097	1	137,54	16
3881-67-1.6-THQ-2/3	7311518328832	1	85,70	16
3881-67-1.6-THS-1.4/2	7314150138791	1	150,04	16
3881-67-1.6-THS-1/1.25	7311518269043	1	150,04	16
3881-67-1.6-THS-2/3	7311518328849	1	150,62	16
3881-80-1.6-THQ-7/1	7311518332938	1	143,32	16
3881-80-1.6-THQ-1.4/2	7311518328856	1	143,32	16
3881-80-1.6-THQ-1/1.25	7314150133918	1	150,04	16
3881-80-1.6-THQ-2/3	7311518328863	1	198,64	16





3905-300-24-100	7311518292225	100	2,37	546
3905-300-24-2P	7311518299248	10	6,17	546
3905-300-32-100	7311518292232	100	2,21	546
3906-250-18-100	7311518250997	100	1,99	545
3906-250-18-5P	7314150265534	10	10,48	545
3906-250-24-100	7311518251000	100	1,99	545
3906-250-24-5P	7314150265541	10	10,48	545
3906-250-32-100	7311518251017	100	1,99	545
3906-250-32-5P	7314150265558	10	10,48	545
3906-300-14-100	7311518233563	100	2,24	545
3906-300-14-10P	7311518233693	10	34,88	545
3906-300-14-5P	7314150265565	10	11,79	545
3906-300-18-100	7311518233570	100	2,24	545
3906-300-18-10P	7311518233723	10	22,33	545
3906-300-18-2P	7311518233617	10	6,17	545
3906-300-18-5P	7314150265572	10	14,47	545
3906-300-24-100	7311518233587	100	2,24	545
3906-300-24-10P	7311518233730	10	28,42	545
3906-300-24-2P	7311518233624	10	6,17	545
3906-300-24-5P	7311518237417	10	14,47	545
3906-300-32-100	7311518233594	100	2,24	545
3906-300-32-10P	7311518233747	10	28,42	545
3906-300-32-2P	7311518233631	10	6,17	545
3906-300-32-5P	7311518237424	10	14,47	545
3906-300-3P	7311518233754	10	8,96	545
3911-115-T41-AL	7314150485642	25	1,01	148
3911-115-T41-I	7314150454570	25	1,01	148
3911-115-T41-IM	7314150454587	50	0,96	148
3911-115-T42-M	7314150454679	25	0,91	148
3911-115T41-IM	7314150460599	25	0,96	148
3911-125-T41-AL	7314150485666	25	1,01	148
3911-125-T41-I	7314150454594	25	1,16	148
3911-125-T41-IM	7314150454600	50	1,16	148
3911-125-T42-M	7314150454686	25	1,01	148
3911-125T1T41-IM	7314150485444	25	1,01	148
3911-150-T41-I	7314150454624	50	2,11	148
3911-150-T42-M	7314150454709	25	1,70	148
3911-180-T41-I	7314150454631	50	2,49	148
3911-180-T41-IM	7314150454655	50	2,22	148
3911-180-T42-M	7314150454693	25	2,22	148
3911-180T1T41-IM	7314150485468	50	1,74	148
3911-230-T41-I	7314150454648	50	3,17	148
3911-230-T41-IM	7314150454662	50	3,17	148
3911-230-T42-M	7314150454716	50	3,17	148
3911-2301922XDT	7314150522439	50	2,64	148
3911-230T1T41-IM	7314150485482	50	2,40	148
3911-2302522XDT	7314150522415	50	2,51	148
3911-2303T41-IM	7314150485628	50	2,86	148
3911-350-X2TM	7314150486366	35	5,84	148
3911-400-F2TM	7314150485963	15	12,04	148
3911-400-X2TM	7314150502967	15	12,62	148
3911-751010XTM	7314150522392	10	1,15	148
3912-115-T41-IM	7314150454808	25	0,84	148
3912-115-T42-ST	7314150454723	25	0,96	148
3912-125-T41-IM	7314150454815	25	0,91	148
3912-125-T42-ST	7314150454730	25	1,28	148
3912-180-T42-ST	7314150454747	25	1,38	148
3912-230-T42-ST	7314150454754	50	2,22	148
3916-115-10P-CE	7314150455348	100	17,51	149
3916-115-10S-UE	7314150455270	100	11,99	149
3916-125-10P-CE	7314150455355	100	21,64	149
3916-125-10S-UE	7314150455287	100	14,75	149
3916-150-10S-UE	7314150455294	50	17,56	149
3916-180-10S-UE	7314150455300	50	18,62	149
3916-230-10L-RC	7314150455232	25	46,36	149
3916-230-10S-UE	7314150455317	25	26,15	149
3917-115-7S-C	7314150455324	100	6,68	149
3917-115-7S-U	7314150455249	100	6,47	149
3917-125-7S-C	7314150455331	100	8,38	149
3917-125-7S-U	7314150455256	100	8,59	149
3917-230-7S-U	7314150455263	25	19,10	149
3921-115-T27-IM	7314150454617	25	1,43	148
3921-125-T27-IM	7314150454761	25	1,80	148
3921-150-T27-IM	7314150454778	25	2,49	148
3921-180-T27-IM	7314150454785	25	2,86	148
3921-230-T27-IM	7314150454792	25	4,35	148
3926-115IM-C120	7314150454860	20	3,40	148
3926-115IM-C40	7314150454839	20	3,40	148
3926-115IM-C60	7314150454846	20	3,40	148
3926-115IM-C80	7314150454853	20	3,40	148
3926-125IM-C120	7314150454914	20	4,03	148
3926-125IM-C40	7314150454884	20	4,03	148
3926-125IM-C60	7314150454891	20	4,03	148
3926-125IM-C80	7314150454907	20	4,03	148
3927-115IM-P120	7314150454952	20	2,34	149
3927-115IM-P40	7314150454921	20	2,34	149
3927-115IM-P60	7314150454938	20	2,34	149
3927-115IM-P80	7314150454945	20	2,34	149
3927-125-120-3P	7314150499007	12	8,30	149
3927-125-40-3P	7314150498949	12	8,30	149
3927-125-60-3P	7314150498963	12	8,30	149
3927-125-80-3P	7314150498987	12	8,30	149
3927-125IM-P120	7314150455010	20	2,71	149
3927-125IM-P40	7314150454976	20	2,71	149
3927-125IM-P60	7314150454983	20	2,71	149
3927-125IM-P80	7314150455003	20	2,71	149



3940-100-14-SC-2P	7314150364466	10	5,55	140
3940-100-14-SC-5P	7314150364473	5	13,86	140
3940-100-14-ST-10P	7314150364336	1	26,50	140
3940-100-14-ST-2P	7314150364312	10	5,55	140
3940-100-14-ST-5P	7314150364329	5	13,86	140
3940-100-18-SC-2P	7314150364442	10	5,55	140
3940-100-18-SC-5P	7314150364459	5	13,86	140
3940-100-18-ST-10P	7314150364367	1	26,50	140
3940-100-18-ST-2P	7314150364343	10	5,55	140
3940-100-18-ST-5P	7314150364350	5	13,86	140
3940-100-24-SC-2P	7314150364558	10	5,55	140
3940-100-24-SC-5P	7314150364565	5	13,86	140
3940-100-24-ST-10P	7314150364435	1	26,50	140
3940-100-24-ST-2P	7314150364411	10	5,55	140
3940-100-24-ST-5P	7314150364428	5	13,86	140
3940-150-10-HST-10P	7314150364039	1	37,39	140
3940-150-10-HST-2P	7314150364015	10	8,25	140
3940-150-10-HST-5P	7314150364022	5	20,64	140
3940-150-10-ST-100P	7314150362196	1	329,59	140
3940-150-10-ST-10P	7314150362189	1	34,74	140
3940-150-10-ST-2P	7314150362165	5	7,29	140
3940-150-10-ST-5P	7314150362172	5	18,23	140
3940-150-14-HST-10P	7314150362370	1	37,80	140
3940-150-14-HST-2P	7314150362325	10	8,37	140
3940-150-14-HST-5P	7314150362363	5	20,94	140
3940-150-14-ST-100P	7314150364183	1	329,59	140
3940-150-14-ST-10P	7314150364176	1	34,74	140
3940-150-14-ST-2P	7314150364152	10	7,29	140
3940-150-14-ST-5P	7314150364169	5	18,23	140
3940-150-18-HST-10P	7314150364060	1	37,80	140
3940-150-18-HST-2P	7314150364046	10	8,37	140
3940-150-18-HST-5P	7314150364053	5	20,94	140
3940-150-18-ST-100P	7314150364107	1	329,59	140
3940-150-18-ST-10P	7314150364091	1	34,74	140
3940-150-18-ST-2P	7314150364077	10	7,29	140
3940-150-18-ST-5P	7314150364084	5	18,23	140
3940-150-24-ST-100P	7314150364404	1	329,59	140
3940-150-24-ST-10P	7314150364398	1	34,74	140
3940-150-24-ST-2P	7314150364374	5	7,29	140
3940-150-24-ST-5P	7314150364381	5	18,23	140
3940-150-4/6-SC-10P	7314150361847	1	34,74	141
3940-150-4/6-SC-2P	7314150361823	10	9,55	141
3940-150-4/6-SC-5P	7314150361830	5	18,23	141
3940-150-5/8-DSL-10P	7314150361991	1	36,36	141
3940-150-5/8-DSL-2P	7314150361977	5	11,05	141
3940-150-5/8-DSL-5P	7314150361984	5	19,10	141
3940-150-5/8-SL-100P	7314150361724	1	329,59	141
3940-150-5/8-SL-10P	7314150361717	1	34,74	141
3940-150-5/8-SL-2P	7314150361687	10	9,55	141
3940-150-5/8-SL-5P	7314150361700	5	18,23	141
3940-150-6-ST-10P	7314150361786	1	34,74	141
3940-150-6-ST-2P	7314150361762	10	9,55	141
3940-150-6-ST-5P	7314150361779	5	18,23	141
3940-150-8/12-ST-100P	7314150362158	1	329,59	140
3940-150-8/12-ST-10P	7314150362141	1	34,74	140
3940-150-8/12-ST-2P	7314150362127	10	7,29	140
3940-150-8/12-ST-5P	7314150362134	5	18,23	140
3940-228-10-DSL-100P	7314150362035	1	627,76	141
3940-228-10-DSL-10P	7314150362028	1	62,77	141
3940-228-10-DSL-2P	7314150362004	10	13,93	141
3940-228-10-DSL-5P	7314150362011	5	34,79	141
3940-228-10-HST-100P	7314150362417	1	644,25	140
3940-228-10-HST-10P	7314150362400	1	47,42	140
3940-228-10-HST-2P	7314150362387	10	9,46	140
3940-228-10-HST-5P	7314150362394	5	25,73	140
3940-228-10-PR09-100P	7314150361625	1	426,72	141
3940-228-10-ST-100P	7314150362110	1	424,98	140
3940-228-10-ST-10P	7314150362103	1	44,62	140
3940-228-10-ST-2P	7314150362080	10	13,16	140
3940-228-10-ST-5P	7314150362097	5	23,64	140
3940-228-10/14-PR09-100P	7314150361526	1	321,12	141
3940-228-10/14-PR09-10P	7314150361519	1	32,13	141
3940-228-10/14-PR13-100P	7314150361649	1	441,93	141
3940-228-10/14-PR13-10P	7314150451265	1	44,19	141
3940-228-14-HST-10P	7314150362226	1	48,43	140
3940-228-14-HST-2P	7314150362202	10	10,54	140
3940-228-14-HST-5P	7314150362219	5	26,37	140
3940-228-14-ST-100P	7314150364145	1	424,98	140
3940-228-14-ST-10P	7314150364138	1	44,62	140
3940-228-14-ST-2P	7314150364114	10	9,46	140
3940-228-14-ST-5P	7314150364121	5	23,64	140
3940-228-18-HST-10P	7314150362271	1	51,91	140
3940-228-18-HST-2P	7314150362233	10	10,38	140
3940-228-18-HST-5P	7314150362264			

			€	
3940-228-8/12-ST-10P	7314150362066	1	44,62	140
3940-228-8/12-ST-2P	7314150362042	5	9,46	140
3940-228-8/12-ST-5P	7314150362059	5	23,64	140
3940-300-10-HST-10P	7314150362448	1	55,66	140
3940-300-10-HST-2P	7314150362424	10	12,49	140
3940-300-10-HST-5P	7314150362431	5	31,26	140
3940-300-14-HST-10P	7314150362301	1	55,66	140
3940-300-14-HST-2P	7314150362288	10	12,55	140
3940-300-14-HST-5P	7314150362295	5	31,34	140
3940-300-14-ST-100P	7314150364268	1	528,83	140
3940-300-14-ST-10P	7314150364251	1	55,63	140
3940-300-14-ST-2P	7314150364237	10	11,65	140
3940-300-14-ST-5P	7314150364244	5	29,14	140
3940-300-18-HST-10P	7314150364008	1	54,55	140
3940-300-18-HST-2P	7314150363988	10	12,33	140
3940-300-18-HST-5P	7314150363995	5	30,86	140
3940-300-18-ST-100P	7314150364305	1	527,78	140
3940-300-18-ST-10P	7314150364299	1	55,63	140
3940-300-18-ST-2P	7314150364275	10	11,65	140
3940-300-18-ST-5P	7314150364282	5	29,14	140
3940-300-5/8-DSL-10P	7314150361960	1	58,39	141
3940-300-5/8-DSL-2P	7314150361946	10	12,27	141
3940-300-5/8-DSL-5P	7314150361953	5	30,62	141
3940-300-6-SL-10P	7314150361816	1	55,63	141
3940-300-6-SL-2P	7314150361793	10	11,05	141
3940-300-6-SL-5P	7314150361809	5	29,14	141
3940-300-8/12-SL-100P	7314150361908	1	517,19	141
3940-300-8/12-SL-10P	7314150361892	1	55,63	141
3940-300-8/12-SL-2P	7314150361878	5	11,05	141
3940-300-8/12-SL-5P	7314150361885	5	29,14	141
3940-HDD-SET-5P	7314150401703	5	34,53	143
3940-METAL-SET-12P	7314150511488	6	54,38	143
3940-METAL-SET-5P	7314150401673	5	22,66	142
3940-MIX-SET-10P	7314150401666	4	46,39	143
3940-MIX-SET-12P	7314150511501	6	55,66	143
3940-MIX-SET-5P	7314150401659	5	25,88	143
3942-150-7-SL-10P	7314150364534	1	36,87	142
3942-150-7-SL-2P	7314150364510	10	19,82	142
3942-150-7-SL-5P	7314150364527	5	19,82	142
3942-228-11-HSL-10P	7314150364831	1	31,77	142
3942-228-11-HSL-2P	7314150364817	10	9,00	142
3942-228-11-HSL-5P	7314150364824	5	18,99	142
3942-228-5-HSL-10P	7314150364657	1	47,43	142
3942-228-5-HSL-2P	7314150364633	10	12,63	142
3942-228-5-HSL-5P	7314150364640	5	25,75	142
3942-228-7-HSL-10P	7314150364749	1	44,62	141
3942-228-7-HSL-2P	7314150364725	10	12,41	141
3942-228-7-HSL-5P	7314150364732	5	24,16	141
3942-228-7-SL-10P	7314150364503	1	44,83	142
3942-228-7-SL-2P	7314150364480	10	9,59	142
3942-228-7-SL-5P	7314150364497	5	23,97	142
3942-300-5-HSL-10P	7314150364688	1	53,28	142
3942-300-5-HSL-2P	7314150364664	10	15,72	142
3942-300-5-HSL-5P	7314150364671	5	30,60	142
3942-300-7-HSL-10P	7314150364770	1	51,10	141
3942-300-7-HSL-2P	7314150364756	10	20,78	141
3942-300-7-HSL-5P	7314150364763	5	27,44	141
3942-300-7-SL-10P	7314150364619	1	49,65	142
3942-300-7-SL-2P	7314150364596	10	14,98	142
3942-300-7-SL-5P	7314150364602	5	28,78	142
3942-WOOD-SET-12P	7314150511525	6	72,51	143
3942-WOOD-SET-5P	7314150401680	5	30,21	143
3943-C30-JT-F	7314150422869	10	19,69	142
3943-C30-JT-M	7314150422876	10	19,69	142
3943-C35-JT-C	7314150422937	10	21,32	142
3943-C35-JT-M	7314150422883	10	22,01	142
3943-R28-UT-C-2P	7314150422951	10	17,38	142
3943-S20-JT-F	7314150422944	10	16,22	142
3944-300-3-MEAT-1P	7314150364862	10	11,77	143
3946-100-DG-ST-2P	7314150478644	10	9,40	141
3946-150-10-HST-1P	7314150478156	10	9,40	141
3946-150-6-DSL-1P	7314150478101	10	9,40	141
3946-150-6-SL-1P	7314150364916	5	25,24	143
3946-150-8-HST-1P	7314150478132	10	22,92	140
3946-150-DG-ST-2P	7314150478668	10	16,45	141
3946-228-10-HST-1P	7314150478255	10	36,44	141
3946-228-3-ST-1P	7314150364886	5	24,59	143
3946-228-6-DSL-1P	7314150478217	10	29,09	141
3946-228-8-HST-1P	7314150478231	10	31,73	140
3946-300-10-HST-1P	7314150478323	10	49,36	141
3946-300-2-CB-1P	7314150478354	10	35,26	143
3946-300-6-DSL-1P	7314150478286	10	32,91	141
3946-300-8-HST-1P	7314150478309	10	41,01	140
3946-457-2-CB-1P	7314150478378	10	47,01	143
396-BLADE	7311518299057	100	16,36	620
396-BLADE-1P	7311518330613	1	14,96	620
396-HP	7311518152284	4	20,58	620
396-HP-BLADE	7311518156404	200	13,31	621
396-INS	7314150422708	10	26,74	549
396-JS	7311518223250	4	24,21	620
396-JS-BLADE	7311518223267	200	21,78	621
396-JT	7311518168056	4	24,21	620
396-JT-BLADE	7311518168063	200	21,78	621
396-LAP	7311518172367	10	39,59	620
4-138-06-1-0	7311518020927	10	7,83	29
4-138-06-1-2	7311518000592	5	11,11	29

\* Hasta agotar existencias

			€	
4-138-08-1-0	7311518020934	10	10,07	29
4-138-08-1-2	7311518000615	5	13,40	29
4-138-10-1-0	7311518020958	10	12,40	29
4-138-10-1-2	7311518000646	5	15,54	29
4-138-12-1-0	7311518020965	5	17,32	29
4-138-12-1-2	7311518194734	5	20,06	29
4-140-06-1-0	7311518020989	10	8,19	29
4-140-08-1-0	7311518020996	10	10,22	29
4-140-08-1-2	7311518028169	5	13,40	29
4-140-10-1-0	7311518022488	10	12,55	29
4-140-10-1-2	7311518194741	5	15,80	29
4-142-06-1-0	7311518021016	10	7,55	29
4-142-08-1-0	7311518021023	10	8,73	29
4-142-10-1-0	7311518021030	10	11,42	29
4-144-08-2-0	7311518021054	10	10,56	29
4-144-08-2-2	7311518201319	5	13,79	30
4-152-08-2-2	7311518000691	5	16,93	30
4-153-08-1-2	7311518000707	5	16,93	30
4-154-08-2-2	7311518000714	10	32,12	30
4-155-08-2-0	7311518116194	10	12,59	30
4-155-10-2-0	7311518116200	5	16,67	30
4-183-04-2-0	7311518021108	10	4,53	30
4-183-04-2-2	7311518201401	5	6,38	30
4-183-05-2-0	7311518021122	10	5,24	30
4-183-05-2-2	7311518201418	5	7,82	30
4-183-06-2-0	7311518021139	10	6,24	30
4-183-06-2-2	7311518000769	5	8,01	30
4-183-07-2-0	7311518021146	10	7,41	30
4-183-07-2-2	7311518194710	5	9,49	30
4-183-08-2-0	7311518021153	10	9,87	30
4-183-08-2-2	7311518194727	5	11,29	30
4-183-10-2-0	7311518021160	10	12,34	30
4-186-04-2-0	7311518021191	10	5,29	30
4-186-04-2-2	7311518201425	5	6,79	30
4-186-05-2-0	7311518021214	10	5,29	30
4-186-05-2-2	7311518028213	5	7,54	30
4-186-06-2-0	7311518021221	10	5,29	30
4-186-06-2-2	7311518000837	5	8,01	30
4-186-07-2-0	7311518021238	10	7,49	30
4-186-08-2-0	7311518021245	10	8,46	30
4-186-45-2-0*	7311518021207	10	5,29	30
4-187-04-2-0	7311518021269	10	5,59	31
4-187-05-2-0	7311518021283	10	6,04	31
4-187-05-2-2	7311518201449	5	8,17	31
4-187-06-2-0	7311518021290	10	6,39	31
4-187-06-2-2	7311518022464	5	9,75	31
4-187-07-2-0	7311518021306	10	9,09	31
4-187-45-2-0*	7311518021276	10	6,04	31
4-188-05-2-0	7311518021337	10	7,33	31
4-188-05-2-2	7311518201456	5	9,37	31
4-188-06-2-0	7311518021344	10	8,19	31
4-188-06-2-2	7311518000899	5	8,03	31
4-190-07-2-0	7311518021375	10	7,41	31
4-190-07-2-2	7311518000905	5	9,66	31
4-190-08-2-0	7311518021382	10	7,91	31
4-190-08-2-2	7311518000912	5	8,92	31
4-192-06-2-0	7311518021412	10	8,66	31
4-192-06-2-2	7311518201463	5	11,99	31
4-192-07-2-0	7311518021429	10	9,87	31
4-192-08-2-0	7311518021436	10	10,56	31
4-192-08-2-2	7311518201487	5	13,79	31
4-202-85-2-0	7311518021474	10	10,78	31
4-204-85-2-0	7311518021498	10	13,75	31
4-272-05-3-2	7311518201500	5	11,99	32
4-272-06-3-0	7311518021597	10	8,73	32
4-272-06-3-2	7311518001025	5	11,99	32
400.002.050	7314150249848	1	494,20	595
400.003.020	8412814403205	1	89,67	595
400.003.030	8412814403304	1	214,40	595
401-16	7314150400270	12	32,01	271
401-28	7314150384082	12	32,01	272
402-15-95	7314150485604	1	9,73	273
402-35	7314150384099	6	57,50	272
402-76*	7314150384105	6	117,63	272
402-95-SET	7314150400997	1	37,89	273
4020L-M-3.2	7314151405038	5	20,18	45
4020L-M-3.5	7314151077709	5	20,18	45
4020L-M-4	7314151077716	5	19,06	45
4020L-M-4.5	7314151077723	5	19,06	45
4020L-M-5	7314151077730	5	19,06	45
4020L-M-5.5	7314151077747	5	19,06	45
4040M-10-11	7314151078287	1	41,98	61
4040M-10-13	7314153000750	1	46,63	61
4040M-12-13	7314151078294	1	43,72	61
4040M-13-17*	7314151804565	1	45,58	61
4040M-14-15	7314151078300	1	45,84	61
4040M-16-17	7314151078317	1	50,02	61
4040M-16-18*	7314151839635	1	51,52	61
4040M-18-19	7314151078324	1	57,00	61
4040M-20-22*	7314151078331	1	67,71	61
4040M-21-23*	7314151078348	1	70,54	61
4040M-24-27	7314151831974	1	73,85	61
4040M-				

# 4040Z-1/2-9/16\*



4040Z-1/2-9/16*	7314151831998	1	45,01	61
4040Z-13/16-7/8*	7314150355099	1	58,83	61
4040Z-3/8-7/16*	7314151831981	1	40,53	61
4040Z-5/8-11/16*	7314151832001	1	47,98	61
4040Z-5/8-3/4*	7314153001023	1	51,21	61
405-1000	7314150399758	5	62,64	528
405-1000-M	7314150399765	5	66,53	528
405-400	7314150399673	5	30,65	528
405-400-M	7314150399680	5	34,54	528
405-600	7314150399697	5	36,66	528
405-600-M	7314150399703	5	40,65	528
405-800	7314150399710	10	46,65	528
405-800-M	7314150399741	5	50,53	528
405L-400	7314150400461	10	28,00	528
405L-400-M	7314150400492	5	31,32	528
405L-600	7314150400478	10	34,00	528
405L-600-M	7314150400485	5	38,00	528
406-300	7314150183678	1	36,63	528
406-300-M	7314150186358	5	50,33	528
406-400	7314150183685	5	41,50	528
406-400-M	7314150183838	5	55,33	528
406-500	7314150183692	5	50,07	528
406-500-M	7314150186365	5	60,67	528
406-600	7314150245819	5	49,08	528
406-600-M	7314150245840	5	59,47	528
406-800	7314150245826	5	58,05	528
406P-400	7314150302574	10	10,51	528
406P-600	7314150302581	10	13,30	528
406T-225	7314150315130	10	7,00	529
407-1000*	7314150369928	6	17,62	581
407-1400*	7314150373703	6	19,70	581
407-700*	7314150369911	5	15,87	581
407F-1000	7314150383801	6	20,35	581
407F-1400	7314150383818	6	23,24	581
407F-700	7314150383795	6	18,45	581
40B-115-165	7314153011879	25	62,63	62
40B-115-165-SP	7314153024459	1	4,40	62
40B-150-230	7314153024534	10	63,68	62
40B-165-230*	7314150214587	1	100,89	62
40B-19-50	7314153011848	25	24,96	62
40B-19-50-SP	7314153024473	1	3,72	62
40B-22-35*	7314150214563	1	39,06	62
40B-32-75	7314153011855	25	36,53	62
40B-32-75-SP	7314153024497	1	3,72	62
40B-50-120	7314153011862	20	46,07	62
40B-50-120-SP	7314153024510	1	4,40	62
4106-115-165	7314153024572	25	40,60	62
4106-150-230	7314153024596	10	90,75	62
4106-19-50	7314153011886	10	28,18	62
4106-20-35*	7314150213764	1	36,77	62
4106-32-75	7314153011893	25	41,08	62
4106-50-120	7314153024558	25	42,02	62
411-26	7314150412068	4	47,00	273
411-26-95	7314150412259	50	17,45	273
411-35	7314150412082	4	61,48	273
411-35-95	7314150412266	50	27,36	273
411-42	7314150412112	6	80,62	273
411-42-95	7314150412273	50	32,34	273
411-63	7314150412136	5	118,60	273
411-63-95	7314150412280	30	61,17	273
412-26-MULTI	7314150412174	5	88,14	273
412-26-MULTI-95	7314150412303	150	20,93	274
412-28-PEX	7314150412150	5	60,27	273
412-28-PEX-95	7314150412297	30	20,83	274
4124-JT-H	7311518267803	4	24,21	620
4128-JT-H	7311518267810	4	29,06	620
4130	7314150100019	3	49,31	237
413005000	8413345011860	12	65,69	584
413010000	8413345011877	12	108,23	584
413015000	8413345011884	12	142,14	584
413020000	8413345011891	6	186,25	584
413030000	8413345119986	1	189,06	584
413040000	8413345119993	1	250,99	584
4131	7314150100026	3	49,31	237
414-10	7311518238148	4	15,88	559
414-12	7311518238155	4	16,93	559
414-14	7311518238162	4	17,27	559
414-15	7311518238179	4	17,42	559
414-16	7311518238186	4	17,61	559
414-18	7311518238193	4	18,09	559
414-20	7311518238209	4	18,43	559
414-22	7311518238216	4	18,90	559
414-25	7311518238223	4	19,41	559
414-28	7311518238230	4	20,06	559
414-30	7311518238247	4	20,38	559
414-32	7311518238254	4	20,72	559
414-35	7311518238261	4	21,37	559
414-38	7311518238278	4	21,87	559
414-6	7311518238117	4	15,71	559
414-8	7311518238131	4	16,07	559
414-S3-EUR	7311518249205	1	54,41	559
416-1000	7314150314027	10	27,49	528
416-1200	7314150308798	10	31,17	528
416-1500	7314150314034	10	35,23	528
416-1800	7314150308804	10	40,96	528
416-2000	7314150308811	10	48,80	528



416-400	7314150314003	10	16,45	528
416-600	7314150308781	10	19,29	528
416-800	7314150314010	10	22,25	528
416-SET-1	7314150308828	5	70,31	529
416-SET-2	7314150308835	5	73,25	529
416-SET+BAG	73141503065470	1	104,10	528
41RM-10	7314153014429	60	24,76	47
41RM-11	7314153014436	60	26,03	47
41RM-12	7314153014443	60	28,10	47
41RM-13	7314153014450	60	28,91	47
41RM-14	7314153014467	30	30,31	47
41RM-17	7314153014474	30	34,27	47
41RM-19	7314153014481	30	38,72	47
41RM-21	7314150219742	30	40,38	47
41RM-8	7314153014412	60	22,73	47
41RM/SH8	7314150220656	10	241,62	48
41RZ-1/2	7314150359011	1	24,39	47
41RZ-11/16	7314150359042	1	30,18	47
41RZ-13/16	7314150359066	30	46,66	47
41RZ-3/4	7314150359059	1	32,26	47
41RZ-3/8	7314150358991	1	21,58	47
41RZ-5/16	7314150358984	1	20,39	47
41RZ-5/8	7314150359035	30	28,92	47
41RZ-7/16	7314150359004	1	22,31	47
41RZ-7/8	7314150359073	1	46,66	47
41RZ-9/16	7314150359028	1	25,76	47
420SC-25	7314150169825	10	5,89	575
420SC-50	7314150169832	5	8,79	575
420SH-100-200	7314150359691	10	38,08	574
420SH-120-1000	7314150359790	6	69,08	574
420SH-120-1250	7314150359806	6	78,49	574
420SH-120-1500	7314150359813	6	82,39	574
420SH-120-250	7314150359707	8	45,13	574
420SH-120-300	7314150359745	8	48,99	574
420SH-120-400	7314150359752	6	51,45	574
420SH-120-500	7314150359769	6	54,92	574
420SH-120-600	7314150359776	6	59,37	574
420SH-120-800	7314150359783	6	65,31	574
420SH-140-400	7314150359820	6	65,31	574
420SH-175-400	7314150359837	6	69,65	574
420SH-50-100	7314150359646	10	14,90	574
420SH-50-200	7314150359653	10	16,50	574
420SH-60-120	7314150359660	12	24,45	574
420SH-60-300	7314150359677	12	29,14	574
420SH-80-160	7314150359684	12	32,41	574
4211-11-6T	7311518152000	4	18,16	620
4211-14-6T	7311518128883	4	20,58	620
4212-11-6T	7311518002060	4	18,16	620
4212-14-6T	7311518002077	4	20,58	620
422P-10	7311518248369	4	37,97	560
422P-12	7311518248376	4	37,97	560
422P-16	7311518248383	4	37,97	560
422P-20	7311518248390	4	40,23	560
422P-25	7311518248406	4	47,79	560
422P-6	7311518248352	4	37,50	560
4231	7314150100033	3	67,78	239
4239	7314150100088	3	66,48	239
424P-10	7311518238315	4	19,67	558
424P-12	7311518238322	4	20,14	558
424P-14	7311518238339	4	20,61	558
424P-15	7311518238346	4	20,83	558
424P-16	7311518238353	4	21,07	558
424P-18	7311518238360	4	21,54	558
424P-20	7311518238377	4	22,00	558
424P-22	7311518238384	4	22,45	558
424P-24	7311518238391	4	22,93	558
424P-25	7311518238407	4	23,13	558
424P-26	7311518238414	4	23,39	558
424P-28	7311518238421	4	23,87	558
424P-30	7311518238438	4	24,33	558
424P-32	7311518238445	4	24,78	558
424P-35	7311518238452	4	25,48	558
424P-38	7311518238469	4	26,18	558
424P-4	7311518238285	4	18,28	558
424P-40	7311518238476	4	26,65	558
424P-6	7311518238292	4	18,75	558
424P-8	7311518238308	4	19,21	558
424P-S3-EUR	7311518249199	1	64,84	558
424P-S6-EUR	7311518269968	1	149,03	559
424P-S6-GER	7311518280086	1	138,60	559
424P-S6-LR	7314150423804	1	141,79	558
424P-S6-PP	7314150326662	1	100,92	559
424P-S8-EUR	7311518276393	1	203,23	559
425-081	7311518010669	1	49,39	560
425-082	7311518010676	1	78,68	560
425-083	7311518010683	1	103,90	560
425-10	7311518004613	4	14,98	560
425-12	7311518004620	4	15,34	560
425-14	7311518004637	4	15,69	560
425-15	7311518011767	4	15,87	560
425-16	7311518004644	4	16,05	560
425-18	7311518004651	4	16,42	560
425-20	7311518004668	4	16,76	560
425-22	7311518004675	4	17,10	560
425-24	7311518005993	4	17,48	560
425-25	7311518004682	4	17,64	560





425-26	7311518006006	4	17,82	560
425-28	7311518004699	4	18,17	560
425-30	7311518004705	4	18,55	560
425-32	7311518004712	4	18,87	560
425-35	7311518017774	4	19,43	560
425-38	7311518004729	4	19,98	560
425-4	7311518030810	4	13,92	560
425-40	7311518017781	4	20,28	560
425-6	7311518004590	4	14,43	560
425-8	7311518004606	4	14,64	560
426-1000	7311518004309	1	48,68	527
426-1200	7311518004316	1	57,26	527
426-400	7311518004255	1	32,56	527
426-600	7311518004279	1	36,72	527
426-800	7311518004293	1	41,01	527
426TOR9	7314150125319	10	23,72	529
427-13*	7314150403578	4	21,72	578
427-16	7311518025410	4	29,96	578
427-20	7311518025427	4	30,98	578
427-24*	7314150402878	4	33,58	578
427-700*	7314150338092	6	24,74	578
427-8*	7314150402854	4	19,72	578
427S-16*	7314150404247	4	23,12	578
427S-20*	7314150404261	4	25,50	578
428-16	7311518012380	4	28,18	578
428-700*	7314150338108	6	32,03	579
428F-13	7314150436392	4	28,35	578
428F-16	7314150436408	4	31,57	578
428F-20	7314150436422	4	33,60	578
428F-24	7314150436439	4	46,01	578
428F-8	7314150436378	4	25,48	578
428S-16*	7314150424030	4	31,57	578
428S-20*	7314150424047	4	33,60	578
429-13	7311518012250	4	27,66	578
429-16	7311518012403	4	30,15	578
429-20	7311518012410	4	31,02	578
429-8	7311518040703	4	19,00	578
42RM/S12	7314150384785	1	353,26	48
4307	7314151079444	1	78,85	62
4310	7314151079451	1	106,55	62
434-10	7311518238506	4	24,66	558
434-12	7311518238513	4	25,25	558
434-14	7311518238520	4	25,83	558
434-15	7311518238537	4	26,10	558
434-16	7311518238544	4	26,54	558
434-18	7311518238551	4	26,98	558
434-20	7311518238568	4	27,53	558
434-22	7311518238575	4	28,25	558
434-25	7311518238582	4	28,97	558
434-28	7311518238599	4	30,01	558
434-30	7311518238605	4	30,45	558
434-32	7311518238612	4	31,02	558
434-35	7311518238629	4	31,87	558
434-38	7311518238636	4	32,89	558
434-50	7311518285388	4	37,75	558
434-6	7311518238483	4	23,53	558
434-8	7311518238490	4	24,27	558
434-S3-EUR	7311518249212	1	81,21	558
434-S6-EUR	7311518267544	1	160,69	558
434-S6-LR	7314150423811	1	181,00	558
434-S6-PP	7314150326655	1	162,79	558
434-S8-EUR	7311518295110	1	183,53	558
439000000	8413345129282	1	13,14	459
439000001	7314150268788	1	13,30	459
439000003*	7314150309719	1	24,12	459
439000004*	7314150427666	1	7,32	459
4400-11	7311518200596	10	11,79	621
4400-11-BULK	7311518200633	10	10,29	621
4400-14	7311518200602	10	13,31	621
4400-14-BULK	7311518200640	10	11,49	621
440102500	8413345098977	10	6,21	581
440103000*	8413345098991	10	6,53	581
4411-1.00	7314150372744	1	4,86	157
4411-1.50	7314150372768	1	4,53	157
4411-10.00	7314150372973	1	9,83	157
4411-10.20	7314150372980	1	13,93	157
4411-10.50	7314150470488	1	14,60	157
4411-11.00	7314150372997	1	15,32	157
4411-11.50	7314150470495	1	17,46	157
4411-12.00	7314150373000	1	19,64	157
4411-12.50	7314150470501	1	22,02	157
4411-13.00	7314150373017	1	24,49	157
4411-2.00	7314150372775	1	4,75	157
4411-2.50	7314150372782	1	4,26	157
4411-3.00	7314150372799	1	4,10	157
4411-3.25	7314150372805	1	4,96	157
4411-3.30	7314150372812	1	4,96	157
4411-3.50	7314150372829	1	4,86	157
4411-4.00	7314150372836	1	5,29	157
4411-4.20	7314150372843	1	2,91	157
4411-4.25	7314150372850	1	2,91	157
4411-4.50	7314150372867	1	3,02	157
4411-5.00	7314150372874	1	3,13	157
4411-5.50	7314150372881	1	3,93	157
4411-6.00	7314150372898	1	4,10	157
4411-6.50	7314150372904	1	4,86	157

\* Hasta agotar existencias



4411-6.80	7314150372911	1	4,65	157
4411-7.00	7314150372928	1	5,29	157
4411-7.50	7314150372935	1	5,73	157
4411-8.00	7314150372942	1	6,68	157
4411-8.50	7314150372959	1	7,01	157
4411-9.00	7314150372966	1	8,85	157
4411-9.50	7314150394463	1	8,96	157
4413-1.00	7314150371754	1	3,55	158
4413-1.50	7314150371761	1	2,81	158
4413-10.00	7314150372034	1	6,13	158
4413-10.20	7314150372041	1	7,87	158
4413-10.50	7314150470556	25	8,19	158
4413-11.00	7314150372058	1	9,01	158
4413-11.50	7314150470563	25	9,76	158
4413-12.00	7314150372065	1	10,65	158
4413-12.50	7314150470570	25	11,62	158
4413-13.00	7314150372072	1	12,18	158
4413-2.00	7314150371785	1	2,81	158
4413-2.50	7314150371792	1	2,81	158
4413-3.00	7314150371815	1	2,85	158
4413-3.25	7314150371822	1	2,85	158
4413-3.30	7314150371877	1	2,85	158
4413-3.50	7314150371884	1	2,85	158
4413-4.00	7314150371891	1	3,06	158
4413-4.20	7314150371907	1	1,91	158
4413-4.25	7314150371914	1	1,91	158
4413-4.50	7314150371921	1	2,01	158
4413-5.00	7314150371938	1	2,17	158
4413-5.50	7314150371945	1	2,99	158
4413-6.00	7314150371952	1	2,99	158
4413-6.50	7314150371969	1	3,49	158
4413-6.80	7314150371976	1	3,93	158
4413-7.00	7314150371983	1	4,10	158
4413-7.50	7314150371990	1	4,40	158
4413-8.00	7314150372003	1	4,68	158
4413-8.50	7314150372010	1	5,08	158
4413-9.00	7314150372027	1	6,46	158
4413-9.50	7314150394456	1	5,99	158
4415-1.00	7314150394210	1	0,94	159
4415-1.50	7314150394227	1	0,94	159
4415-10.00	7314150394401	1	2,28	159
4415-10.50	7314150470525	1	2,47	159
4415-11.00	7314150394418	1	3,02	159
4415-11.50	7314150470532	1	3,24	159
4415-12.00	7314150394425	1	3,56	159
4415-12.50	7314150470549	1	3,79	159
4415-13.00	7314150394432	1	4,00	159
4415-13.50	7314150441495	1	5,34	159
4415-14.00	7314150441501	1	5,72	159
4415-14.50	7314150441518	1	6,47	159
4415-15.00	7314150441525	1	6,98	159
4415-15.50	7314150441532	1	7,75	159
4415-16.00	7314150441549	1	8,30	159
4415-16.50	7314150441556	1	8,87	159
4415-17.00	7314150441563	1	9,38	159
4415-17.50	7314150441570	1	10,36	159
4415-18.00	7314150441587	1	10,72	159
4415-18.50	7314150441594	1	11,67	159
4415-19.00	7314150441600	1	12,18	159
4415-19.50	7314150441617	1	12,68	159
4415-2.00	7314150394234	1	0,94	159
4415-2.50	7314150394241	1	0,94	159
4415-20.00	7314150441624	1	13,32	159
4415-3.00	7314150394258	1	0,94	159
4415-3.25	7314150394265	1	1,07	159
4415-3.50	7314150394272	1	1,15	159
4415-4.00	7314150394289	1	1,15	159
4415-4.25	7314150394296	1	0,78	159
4415-4.50	7314150394302	1	0,85	159
4415-5.00	7314150394319	1	0,85	159
4415-5.50	7314150394326	1	0,94	159
4415-6.00	7314150394333	1	0,98	159
4415-6.50	7314150394340	1	1,07	159
4415-7.00	7314150394357	1	1,15	159
4415-7.50	7314150394364	1	1,35	159
4415-8.00	7314150394371	1	1,63	159
4415-8.50	7314150394388	1	1,83	159
4415-9.00	7314150394395	1	1,94	159
442	7311518002848	10	14,52	536
442 B	7314150008957	1	69,91	270
442-3P	7314150309610	10	23,54	536
4420-11	7311518200619	10	11,79	621
4420-11-BULK	7311518200657	10	10,29	621
4420-14	7311518200626	10	13,31	621
4420-14-BULK	7311518200664	10	11,49	621
443 B	7314150008971	1	82,64	270
4430	7314150100040	3	42,31	248
4435-12.4	7314150465163	1	7,84	160
444 B	7314150009008	1	111,20	270
4480/2-ZD	7311518276911	1	160,35	274
4480IM	7314150263165	1	61,49	274
4480MM	7314150263158	1	61,49	274
449	7311518005337	10	13,70	536
44Z-1/2-9/16	7314150375233	10	34,91	55
44Z-1/4-5/16	7314150375196	10	22,00	55
44Z-11/16-13/16	7314150375264	5	54,20	55





44Z-11/16-3/4	7314150375257	5	43,20	55
44Z-3/8-7/16	7314150375219	10	25,35	55
44Z-5/16-3/8	7314150375202	10	22,00	55
44Z-5/8-3/4	7314150375240	5	43,20	55
44Z-7/16-1/2	7314150375226	10	29,41	55
451	7311518014506	10	15,99	536
4511-0.50-10P	7314150373079	1	27,40	157
4511-0.75-10P	7314150373062	1	24,76	157
4511-1.00-10P	7314150373055	1	20,06	157
4511-1.50-10P	7314150373086	1	19,11	157
4511-1.75-10P	7314150373093	1	23,95	157
4511-10.00-5P	7314150373444	1	45,87	157
4511-10.20-5P	7314150373468	1	64,74	157
4511-10.30-5P	7314150373475	1	77,14	157
4511-10.50-5P	7314150373482	1	64,94	157
4511-10.80-5P	7314150373499	1	89,76	157
4511-11.00-5P	7314150373505	1	71,75	157
4511-11.50-5P	7314150373512	1	85,78	157
4511-12.00-5P	7314150373529	1	91,93	157
4511-12.50-5P	7314150373536	1	111,93	157
4511-12.80-5P	7314150373543	1	127,84	157
4511-13.00-5P	7314150373550	1	114,36	157
4511-13.50-1P	7314150373567	1	25,25	157
4511-14.00-1P	7314150373574	1	24,93	157
4511-14.50-1P	7314150373581	1	35,39	157
4511-15.00-1P	7314150373598	1	35,94	157
4511-15.50-1P	7314150373604	1	41,64	157
4511-16.00-1P	7314150373611	1	43,05	157
4511-16.50-1P	7314150373628	1	49,19	157
4511-17.00-1P	7314150373635	1	49,19	157
4511-17.50-1P	7314150373642	1	54,59	157
4511-18.00-1P	7314150373659	1	59,45	157
4511-18.50-1P	7314150373673	1	65,59	157
4511-19.00-1P	7314150373680	1	65,71	157
4511-19.50-1P	7314150373697	1	72,83	157
4511-2.00-10P	7314150373109	1	20,06	157
4511-2.50-10P	7314150373116	1	18,23	157
4511-2.70-10P	7314150373123	1	22,60	157
4511-2.90-10P	7314150373130	1	22,60	157
4511-20.00-1P	7314150373666	1	78,01	157
4511-3.00-10P	7314150373147	1	17,81	157
4511-3.10-10P	7314150373185	1	21,78	157
4511-3.25-10P	7314150373192	1	21,78	157
4511-3.30-10P	7314150373208	1	21,78	157
4511-3.50-10P	7314150373215	1	21,78	157
4511-3.80-10P	7314150373222	1	27,40	157
4511-4.00-10P	7314150373239	1	23,09	157
4511-4.20-10P	7314150373246	1	25,68	157
4511-4.50-10P	7314150373253	1	25,88	157
4511-4.80-10P	7314150373260	1	30,43	157
4511-5.00-10P	7314150373277	1	27,40	157
4511-5.20-10P	7314150373284	1	33,12	157
4511-5.50-10P	7314150373291	1	34,74	157
4511-6.00-10P	7314150373307	1	36,89	157
4511-6.20-10P	7314150373314	1	46,17	157
4511-6.50-10P	7314150373321	1	44,34	157
4511-6.80-10P	7314150373338	1	51,69	157
4511-7.00-10P	7314150373345	1	48,66	157
4511-7.20-10P	7314150373352	1	70,39	157
4511-7.50-10P	7314150373369	1	51,69	157
4511-7.80-10P	7314150373376	1	84,70	157
4511-8.00-10P	7314150373383	1	60,84	157
4511-8.50-10P	7314150373390	1	63,01	157
4511-8.60-10P	7314150373406	1	103,04	157
4511-8.80-10P	7314150373413	1	103,04	157
4511-9.00-10P	7314150373420	1	80,92	157
4511-9.20-10P	7314150373437	1	114,26	157
4511-9.50-10P	7311518339081	1	83,62	157
4511-9.60-10P	7314150373451	1	134,32	157
4511-SET-19	7314150373031	1	85,13	157
4511-SET-25	7314150373048	1	199,58	157
4511-SET-6	7314150373024	1	20,94	157
4513-1.00-10P	7314150372119	1	17,81	158
4513-1.50-10P	7314150372126	1	13,28	158
4513-1.75-10P	7314150372133	1	14,78	158
4513-10.00-5P	7314150391998	1	31,03	158
4513-10.20-5P	7314150392001	1	39,04	158
4513-10.30-5P	7314150392018	1	49,50	158
4513-10.50-5P	7314150392025	1	40,61	158
4513-10.80-5P	7314150392032	1	61,06	158
4513-11.00-5P	7314150392049	1	44,36	158
4513-11.50-5P	7314150392056	1	48,54	158
4513-12.00-5P	7314150392063	1	52,99	158
4513-12.50-5P	7314150392070	1	58,00	158
4513-12.80-5P	7314150392087	1	101,54	158
4513-13.50-1P	7314150392100	1	20,93	158
4513-14.00-1P	7314150392117	1	22,53	158
4513-14.50-1P	7314150392124	1	24,16	158
4513-15.00-1P	7314150392131	1	24,47	158
4513-15.50-1P	7314150392148	1	27,96	158
4513-16.00-1P	7314150392155	1	29,81	158
4513-16.50-1P	7314150392162	1	32,97	158
4513-17.00-1P	7314150392179	1	32,97	158
4513-17.50-1P	7314150392186	1	37,95	158
4513-18.00-1P	7314150392193	1	40,14	158
4513-18.50-1P	7314150392209	1	44,54	158



4513-19.00-1P	7314150392216	1	44,54	158
4513-19.50-1P	7314150392223	1	47,78	158
4513-2.00-10P	7314150372140	1	12,51	158
4513-2.50-10P	7314150372157	1	12,84	158
4513-2.70-10P	7314150372164	1	15,54	158
4513-2.90-10P	7314150372171	1	15,54	158
4513-3.00-10P	7314150372188	1	11,33	158
4513-3.10-10P	7314150372195	1	13,28	158
4513-3.25-10P	7314150372201	1	13,28	158
4513-3.30-10P	7314150372218	1	13,28	158
4513-3.50-10P	7314150372225	1	13,28	158
4513-3.80-10P	7314150372232	1	18,88	158
4513-4.00-10P	7314150372249	1	16,83	158
4513-4.20-10P	7314150372256	1	18,56	158
4513-4.50-10P	7314150372263	1	19,42	158
4513-4.80-10P	7314150372270	1	21,26	158
4513-5.00-10P	7314150372287	1	21,31	158
4513-5.20-10P	7314150372294	1	23,74	158
4513-5.50-10P	7314150372300	1	27,61	158
4513-6.00-10P	7314150372317	1	28,48	158
4513-6.20-10P	7314150372324	1	32,36	158
4513-6.50-10P	7314150372331	1	33,23	158
4513-6.80-10P	7314150372348	1	37,98	158
4513-7.00-10P	7314150372355	1	40,14	158
4513-7.20-10P	7314150372362	1	50,71	158
4513-7.50-10P	7314150372379	1	42,72	158
4513-7.80-10P	7314150372386	1	62,07	158
4513-8.00-10P	7314150372393	1	48,34	158
4513-8.50-10P	7314150372409	1	52,64	158
4513-8.60-10P	7314150372416	1	83,39	158
4513-8.80-10P	7314150372423	1	85,16	158
4513-9.00-10P	7314150372430	1	63,86	158
4513-9.20-10P	7314150372447	1	86,56	158
4513-9.50-10P	7314150372454	1	61,55	158
4513-9.60-10P	7314150372461	1	97,86	158
4513-SET-19	7314150372096	1	58,82	158
4513-SET-25	7314150372102	1	125,47	158
4513-SET-6	7314150372089	1	16,37	158
4515-1.00-10P	7314150441228	1	3,77	159
4515-1.50-10P	7314150441235	1	3,77	159
4515-10.00-10P	7314150441426	1	23,74	159
4515-10.50-5P	7314150441433	1	13,08	159
4515-11.00-5P	7314150441440	1	15,26	159
4515-11.50-5P	7314150441457	1	16,24	159
4515-12.00-5P	7314150441464	1	16,72	159
4515-12.50-5P	7314150441471	1	17,90	159
4515-13.00-5P	7314150441488	1	19,09	159
4515-2.00-10P	7314150441242	1	3,77	159
4515-2.50-10P	7314150441259	1	3,77	159
4515-3.00-10P	7314150441266	1	3,77	159
4515-3.25-10P	7314150441273	1	5,18	159
4515-3.50-10P	7314150441280	1	5,64	159
4515-4.00-10P	7314150441297	1	5,64	159
4515-4.25-10P	7314150441303	1	6,97	159
4515-4.50-10P	7314150441310	1	6,97	159
4515-5.00-10P	7314150441327	1	7,47	159
4515-5.50-10P	7314150441334	1	8,47	159
4515-6.00-10P	7314150441341	1	8,96	159
4515-6.50-10P	7314150441358	1	9,46	159
4515-7.00-10P	7314150441365	1	13,08	159
4515-7.50-10P	7314150441372	1	14,43	159
4515-8.00-10P	7314150441389	1	15,44	159
4515-8.50-10P	7314150441396	1	18,88	159
4515-9.00-10P	7314150441402	1	21,20	159
4515-9.50-10P	7314150441419	1	23,55	159
4515-SET-19	7314150394449	1	23,30	159
4515-SET-25	7314150441709	1	45,54	159
4518-3	7314151716547	1	262,08	361
4518-4	7314151716622	1	320,22	361
4518-5	7314151716899	1	331,13	361
4519-1	7314151716974	1	278,46	360
4519-1/S	7314151843762	1	63,36	359
4519-2	7314151717193	1	365,62	360
4519-3	7314151717278	1	417,21	360
4521N-0	7314151837723	1	77,89	361
4521N-00	7314151837716	1	77,90	361
4521N-A	7314151837730	1	74,24	361
4521N-B	7314151837747	1	74,24	361
4521N-C	7314151837754	1	76,54	361
4521N-D	7314151837761	1	76,54	361
4521N-E	7314151837778	1	76,54	361
4521N-F	7314151837785	1	87,06	361
4521N-G	7314151837792	1	87,06	361
4521N-H	7314151837808	1	89,56	361
4521N-I	7314151837815	1	99,45	361
4521N-K	7314151837822	1	122,54	361
4521N-L	7314151837839	1	122,54	361
4521N-M	7314151837846	1	152,88	361
4521N-S	7314151839789	1	366,69	361
4521N-T	7314151839796	1	437,52	361
4521N/7	7314151839802	1	1.232,44	361
4522-1	7314151081591	1	66,50	361
4522-2	7314151081614	1	105,08	361
4523G	7314151846695	1	78,73	361
45				

			€	
4528M1	7314151718916	1	127,68	359
4528M2	7314151719050	1	227,28	359
4528M3	7314151719135	1	338,69	359
4528M4	7314151719210	1	408,99	359
4528M5	7314151719487	1	419,44	359
4529-15	7314151719647	1	275,38	358
4529-8	7314151719562	1	228,67	358
4530	7314150100095	3	44,65	250
4532-0	7314151719722	1	126,19	358
4532-A	7314151082109	1	112,08	358
4532-AL	7314150221912	1	120,50	358
4532-B	7314151082116	1	117,10	358
4532-BL	7314150221929	1	127,65	358
4532-C	7314151082123	1	194,07	358
4532-CD/S	7314151818067	1	51,39	358
4532-CL	7314150221936	1	214,27	358
4532-D	7314151082130	1	200,74	358
4532-E	7314151082147	1	313,53	358
4532-EFG/S	7314151838386	1	91,91	358
4532-F	7314151082154	1	347,94	358
4532-G	7314151082161	1	581,43	358
4532-G-SO	7314151841003	1	673,00	358
4532-H	7314151719999	1	1.064,37	358
4532-H/S	7314151838393	1	144,01	358
4532-OAB/S	7314151818050	1	27,14	358
4532K1	7314151082185	1	60,65	358
4532K2	7314151082192	1	102,64	358
4532K3	7314151082208	1	170,39	358
4532K4	7314151720148	1	298,26	358
4532LK1	7314151082215	1	81,98	358
4532LK2	7314151082222	1	137,03	358
4532LK3	7314151082239	1	229,71	358
4532LK4	7314151082246	1	275,78	358
4532LK5	7314151720223	1	288,79	358
4532ST/5	7314151720490	1	948,48	358
4533HP	7314151793043	1	2.793,05	358
4533HP/S	7314150224487	1	603,48	358
4533HPK	7314150224500	1	658,08	358
4533M	7314151793050	1	2.548,85	358
4533M/S	7314150224494	1	200,54	358
4533MK	7314150224517	1	473,14	358
4537-1	7314151720650	1	100,99	359
4537-2	7314151720735	1	180,70	359
4537-3	7314151720810	1	261,42	359
4537-4	7314151721039	1	308,01	359
4540-17	7314150125005	1	266,38	360
4540-17/S	7314150225248	1	40,69	360
4540-25	7314150125012	1	393,71	360
4540-25/S	7314150225286	1	50,83	360
4541-A	7314151082413	1	113,17	359
4541-B	7314151082420	1	189,95	359
4542-A	7314151082451	1	146,33	359
4542-B	7314151082468	1	241,91	359
4543-1	7314151082499	1	36,71	359
4543-1/S	7314151818623	1	15,51	359
4543-10	7314151721466	1	50,80	359
4543-2	7314151082505	1	38,77	359
4543-2/S	7314151818661	1	15,52	359
4543-20	7314151721541	1	54,91	359
4543-3	7314151721381	1	67,60	359
4543-3/S	7314151818708	1	18,57	359
4543-30	7314151721626	1	77,74	359
4544-1	7314151844004	1	83,46	359
4544-10	7314151844042	1	120,24	359
4544-110/S	7314150224777	1	20,10	359
4544-2	7314151844011	1	132,10	359
4544-20	7314151844059	1	179,72	359
4544-220/S	7314150224784	1	39,60	359
4544-3	7314151844028	1	198,05	359
4544-30	7314151844066	1	264,26	359
4544-4	7314151844035	1	270,30	359
4544-440/S	7314150224791	1	48,13	359
4545-1	7314151082543	1	60,34	362
4545-2	7314151082550	1	82,03	362
4545-3	7314151082567	1	106,66	362
4545-4	7314151722272	1	140,39	362
4545-5	7314151722357	1	171,48	362
4545-N1	7314151722432	1	123,40	361
4545-N11	7314150249169	1	289,89	361
4545-N2	7314151804947	1	169,56	361
4545-N21	7314150249176	1	212,33	361
4551-A	7314151082628	1	93,03	360
4551-B	7314151722784	1	118,17	360
4551-C	7314151082642	1	192,68	360
4551-D	7314151082659	1	301,21	360
4552-1	7314151722944	1	147,25	360
4552-2	7314151723088	1	212,76	360
4552-3	7314151723163	1	328,21	360
4553	7314151830649	1	66,24	362
4559-12	7314150113132	1	89,96	242
4559-12A JC	7314150223909	1	55,38	242
4559-18	7314150024513	8	111,86	242
4559-18B JC	7314150113880	1	71,60	242
4559-24	7314150024520	6	133,27	242
4559-24B JC	7314150113897	1	85,29	242
4559-30	7314150024537	5	160,25	242

\* Hasta agotar existencias

			€	
4559-30B JC	7314150113903	1	102,56	242
4559-36	7314150024544	3	210,34	242
4559-36B JC	7314150113910	1	134,62	242
4559-42	7314150024551	2	294,73	242
4559-42A JC	7314150208876	1	130,28	242
4560-210	7314150178995	1	57,40	243
4574	7314151799014	1	1.187,90	360
4577	7314151838348	1	1.527,19	362
4578	7314150222308	1	615,67	361
4579	7314150222018	1	244,93	362
4580N/7	7314151301361	1	1.573,09	360
4581N-1	7314151724139	1	63,93	360
4581NA	7314151301200	1	84,88	360
4581NB	7314151301217	1	91,42	360
4581NB2	7314151724726	1	97,80	360
4581NC	7314151301224	1	98,03	360
4582N-1	7314151724214	1	63,93	360
4582N-2	7314151724481	1	80,14	360
4582NA	7314151301248	1	104,78	360
4582NB	7314151301255	1	109,34	360
4583N-1	7314151724566	1	100,99	360
4583N-2	7314151724641	1	120,76	360
4583NA	7314151301279	1	167,22	360
4583NB	7314151301286	1	274,13	360
4590SHS5	7314150384822	4	206,62	362
4591	7314151804039	1	67,23	362
4592	7314151804046	1	78,39	362
4593	7314151804053	1	96,16	362
4594VWT4*	7314150403639	5	366,58	330
45S/H1.5	7314150218530	1	18,09	172
45S/H1.5-2P	7314150261505	50	7,23	172
45S/H2	7314150218547	1	18,09	172
45S/H2-2P	7314150261512	50	7,23	172
45S/H2.5	7314150218554	1	18,09	172
45S/H2.5-2P	7314150261529	50	7,23	172
45S/H3	7314150218561	1	18,09	172
45S/H3-2P	7314150261536	50	7,23	172
45S/PH1	7314150218516	1	17,40	172
45S/PH1-2P	7314150261482	50	6,95	172
45S/PH2	7314150218523	1	19,50	172
45S/PH2-2P	7314150261499	50	7,80	172
4610-1	7314151724993	1	243,56	362
4611-2	7314151725372	1	81,48	362
4611-3	7314150125043	1	159,61	362
4614-1	7314151725457	1	159,52	360
4614-2	7314151725532	1	194,95	360
4626-10.0	7314150457670	1	9,53	161
4626-4.0	7314150457632	1	5,71	161
4626-5.0	7314150457649	1	6,28	161
4626-6.0	7314150457656	1	6,59	161
4626-8.0	7314150457663	1	7,87	161
4629-10.0	7314150465385	1	8,50	162
4629-4.0	7314150465347	1	5,46	162
4629-5.0	7314150465354	1	5,72	162
4629-6.0	7314150465361	1	6,34	162
4629-8.0	7314150465378	1	7,62	162
4629-SET-5	7314150467204	10	36,62	162
4630	7314150216154	1	24,31	596
4641-10-120	7314150383085	1	5,65	156
4641-10-200	7314150383115	1	8,74	156
4641-10-400	7314150383207	1	14,37	156
4641-10-600	7314150383221	1	15,91	156
4641-11-150	7314150383122	1	6,54	156
4641-12-150	7314150383139	1	7,68	156
4641-12-200	7314150383146	1	10,85	156
4641-12-400	7314150383238	1	15,26	156
4641-12-600	7314150383245	1	17,31	156
4641-13-150	7314150383153	1	10,85	156
4641-14-150	7314150383160	1	12,63	156
4641-14-400	7314150383252	1	18,75	156
4641-14-600	7314150383269	1	21,00	156
4641-16-150	7314150383177	1	13,96	156
4641-16-400	7314150383276	1	20,83	156
4641-16-600	7314150383283	1	26,80	156
4641-18-400	7314150383290	1	30,41	156
4641-18-600	7314150383306	1	36,08	156
4641-20-400	7314150383313	1	32,23	156
4641-20-600	7314150383320	1	41,81	156
4641-22-400	7314150383337	1	37,04	156
4641-24-400	7314150383344	1	38,40	156
4641-25-400	7314150383351	1	43,86	156
4641-3-60	7314150382859	1	3,37	156
4641-4-75	7314150382866	1	3,54	156
4641-5-150	7314150382880	1	4,89	156
4641-5-85	7314150382873	1	3,71	156
4641-5-5-85	7314150382897	1	3,71	156
4641-6-100	7314150383016	1	3,82	156
4641-6-150	7314150383023	1	5,08	156
4641-6-400	7314150383184	1	12,69	156
4641-6-5-100	7314150383030	1	3,82	156
4641-7-100	7314150383047	1	4,32	156
4641-8-120	7314150383054	1	5,01	156
4641-8-200	7314150383061	1	7,36	156
4641-8-400	7314150383191	1	13,45	156
4641-9-120	7314150383078	1	5,01	156
4641-PB	7314150383368	1	22,15	156







4643-PB	7314150441679	1	13,01	156
4651-10-1000	7314150386413	1	103,35	155
4651-10-110	7314150386345	1	12,08	155
4651-10-160	7314150386352	1	12,84	155
4651-10-160-10P	7314150475483	1	128,45	155
4651-10-210	7314150386369	1	15,32	155
4651-10-210-10P	7314150475513	1	161,18	155
4651-10-260	7314150386376	1	19,85	155
4651-10-310	7314150386383	1	25,25	155
4651-10-450	7314150386390	1	34,53	155
4651-10-600	7314150386406	1	44,01	155
4651-12-1000	7314150386581	1	103,78	155
4651-12-160	7314150386529	1	16,09	155
4651-12-160-10P	7314150475490	1	160,81	155
4651-12-210	7314150386536	1	19,21	155
4651-12-210-10P	7314150475520	1	192,03	155
4651-12-260	7314150386543	1	23,21	155
4651-12-310	7314150386550	1	30,11	155
4651-12-450	7314150386567	1	37,67	155
4651-12-600	7314150386574	1	45,22	155
4651-14-1000	7314150386659	1	139,17	155
4651-14-160	7314150386598	1	18,56	155
4651-14-210	7314150386604	1	24,82	155
4651-14-260	7314150386611	1	27,51	155
4651-14-310	7314150386628	1	35,50	155
4651-14-450	7314150386635	1	44,67	155
4651-14-600	7314150386642	1	62,36	155
4651-15-160	7314150386666	1	28,59	155
4651-15-260	7314150386673	1	37,22	155
4651-15-450	7314150386680	1	48,23	155
4651-16-1000	7314150386765	1	165,07	155
4651-16-160	7314150386697	1	35,50	155
4651-16-210	7314150386710	1	39,81	155
4651-16-260	7314150386727	1	46,07	155
4651-16-310	7314150386734	1	48,01	155
4651-16-450	7314150386741	1	60,31	155
4651-16-600	7314150386758	1	80,92	155
4651-18-250	7314150386789	1	61,72	155
4651-18-450	7314150386796	1	72,49	155
4651-20-250	7314150386802	1	70,12	155
4651-20-450	7314150386819	1	82,97	155
4651-22-250	7314150386826	1	84,05	155
4651-22-450	7314150386833	1	100,01	155
4651-24-250	7314150386840	1	85,41	155
4651-24-450	7314150386857	1	105,83	155
4651-25-250	7314150386864	1	87,75	155
4651-25-450	7314150386871	1	107,35	155
4651-28-250	7314150386888	1	101,41	155
4651-28-450	7314150386895	1	122,99	155
4651-30-250	7314150386901	1	129,71	155
4651-30-450	7314150386918	1	134,86	155
4651-32-450	7314150386925	1	174,78	155
4651-5-110	7314150385683	1	8,10	154
4651-5-110-10P	7314150475407	1	80,97	154
4651-5-160	7314150385690	1	9,06	154
4651-5-160-10P	7314150475438	1	90,62	154
4651-5-260	7314150385713	1	16,83	154
4651-5-5-110	7314150385720	1	11,01	154
4651-5-5-110-10P	7314150475414	10	110,05	154
4651-5-5-160	7314150385737	1	11,44	154
4651-5-5-160-10P	7314150475445	1	114,36	154
4651-6-110	7314150385744	1	8,10	155
4651-6-110-10P	7314150475421	1	80,97	155
4651-6-160	7314150385751	1	8,85	155
4651-6-160-10P	7314150475452	1	77,41	155
4651-6-210	7314150385768	1	11,99	155
4651-6-260	7314150385775	1	14,23	155
4651-6-310	7314150385782	1	21,04	155
4651-6-5-110	7314150475391	50	11,42	155
4651-6-5-160	7314150385799	1	11,56	155
4651-6-5-160-10P	7314150475469	1	114,36	155
4651-6-5-210	7314150385805	1	15,54	155
4651-6-5-260	7314150385812	1	20,72	155
4651-6-5-310	7314150385829	1	25,25	155
4651-7-110	7314150385836	1	10,91	155
4651-7-160	7314150386253	1	11,56	155
4651-8-110	7314150386277	1	10,57	155
4651-8-160	7314150386284	1	10,68	155
4651-8-160-10P	7314150475476	1	106,87	155
4651-8-210	7314150386291	1	13,28	155
4651-8-210-10P	7314150475506	1	132,76	155
4651-8-260	7314150386307	1	14,57	155
4651-8-310	7314150386314	1	18,67	155
4651-8-460	7314150386321	1	30,86	155
4651-SET-5	7314150475537	1	45,06	155
4651-SET-7	7314150475544	1	68,40	155
4652-10-110	7314150385119	1	6,38	155
4652-10-160	7314150385126	1	7,12	155
4652-10-160-10P	7314150475322	1	71,20	155
4652-10-210	7314150385133	1	8,53	155
4652-10-210-10P	7314150475353	1	85,29	155
4652-10-260	7314150385140	1	12,51	155
4652-10-310	7314150385164	1	14,57	155
4652-10-450	7314150385171	1	23,64	155
4652-10-600	7314150385188	1	33,02	155
4652-11-160	7314150385195	1	9,39	155



4652-11-260	7314150385218	1	14,57	155
4652-12-1000	7314150385287	1	81,68	155
4652-12-160	7314150385225	1	7,54	155
4652-12-160-10P	7314150475339	1	75,40	155
4652-12-210	7314150385232	1	9,61	155
4652-12-210-10P	7314150475360	1	96,08	155
4652-12-260	7314150385249	1	13,71	155
4652-12-310	7314150385256	1	18,23	155
4652-12-450	7314150385263	1	21,48	155
4652-12-600	7314150385270	1	34,21	155
4652-13-310	7314150385300	1	17,69	155
4652-14-1000	7314150385379	1	88,80	155
4652-14-160	7314150385317	1	10,36	155
4652-14-210	7314150385324	1	15,15	155
4652-14-260	7314150385331	1	18,23	155
4652-14-310	7314150385348	1	19,21	155
4652-14-450	7314150385355	1	25,25	155
4652-14-600	7314150385362	1	37,44	155
4652-15-260	7314150385393	1	18,88	155
4652-16-1000	7314150385478	1	100,88	155
4652-16-210	7314150385416	1	17,59	155
4652-16-260	7314150385423	1	18,99	155
4652-16-310	7314150385430	1	20,28	155
4652-16-450	7314150385447	1	29,98	155
4652-16-600	7314150385454	1	40,35	155
4652-18-1000	7314150385515	1	103,69	155
4652-18-200	7314150385485	1	22,56	155
4652-18-300	7314150385492	1	30,11	155
4652-18-450	7314150385508	1	34,31	155
4652-20-1000	7314150385560	1	104,65	155
4652-20-200	7314150385522	1	31,40	155
4652-20-300	7314150385539	1	35,29	155
4652-20-450	7314150385546	1	44,44	155
4652-20-600	7314150385553	1	65,82	155
4652-22-1000	7314150385607	1	105,73	155
4652-22-250	7314150385577	1	40,35	155
4652-22-450	7314150385584	1	56,09	155
4652-22-600	7314150385591	1	67,22	155
4652-24-250	7314150385614	1	46,94	155
4652-24-450	7314150385621	1	61,07	155
4652-25-1000	7314150385652	1	117,60	155
4652-25-250	7314150385638	1	50,92	155
4652-25-450	7314150385645	1	65,37	155
4652-26-250	7314150385669	1	63,65	155
4652-26-450	7314150385676	1	72,29	155
4652-3-110	7314150475216	50	8,63	155
4652-3-5-110	7314150475223	50	8,63	155
4652-4-110	7314150384365	1	5,93	155
4652-4-160	7314150384372	1	7,12	155
4652-5-110	7314150384815	1	4,30	155
4652-5-5-110-10P	7314150475247	1	43,03	155
4652-5-160	7314150384839	1	5,61	155
4652-5-160-10P	7314150475278	1	56,09	155
4652-5-210	7314150384846	1	8,85	155
4652-5-5-110	7314150384853	1	5,08	155
4652-5-5-110-10P	7314150475254	10	50,77	155
4652-5-5-160	7314150384860	1	6,38	155
4652-5-5-160-10P	7314150475285	1	63,72	155
4652-5-5-210	7314150475230	50	8,63	155
4652-6-110	7314150384877	1	4,43	155
4652-6-110-10P	7314150475261	1	44,30	155
4652-6-160	7314150384891	50	5,18	155
4652-6-160-10P	7314150475292	1	51,79	155
4652-6-210	7314150384907	1	8,42	155
4652-6-260	7314150384969	1	10,77	155
4652-6-5-110	7314150384976	1	5,08	155
4652-6-5-160	7314150384990	1	5,93	155
4652-6-5-160-10P	7314150475308	1	59,40	155
4652-7-110	7314150385003	1	6,38	155
4652-7-160	7314150391981	1	6,81	155
4652-8-110	7314150385034	1	5,29	155
4652-8-160	7314150385058	1	5,61	155
4652-8-160-10P	7314150475315	1	56,09	155
4652-8-210	7314150385065	1	7,54	155
4652-8-210-10P	7314150475346	1	75,40	155
4652-8-260	7314150385072	1	10,68	155
4652-8-460	7314150385089	1	22,56	155
4652-9-160	7314150385096	1	8,53	155
4652-9-210	7314150385102	1	9,28	155
4652-SET-5	7314150475377	1	19,03	156
4652-SET-7	7314150475384	1	29,69	156
4655-FLAT-250	7314150387823	1	11,44	156
4655-HOLLOW-240	7314150387847	1	23,51	156
4655-POINT-250	7314150387816	1	11,44	156
4655-SLOT-25032	7314150387885	1	151,04	156
4655-TILE-20040	7314150387861	1	22,23	156
4655-WIDE-20040	7314150387830	1	19,42	156
4655-WING-C-250	7314150387854	1	56,64	156
4656-12-340	7314150386932	1	65,28	154
4656-12-540	7314150387021	1	76,59	154
4656-14-340	7314150387069	1	70,12	154
4656-14-540	7314150387076	1	80,38	154
4656-15-340	7314150387083	1	80,92	154
4656-16-1320	7314150387137	1	280,50	154
4656-16-340	7314150387106	1	83,62	154
4656-16-540	7314150387113			



4656-16-940	7314150387120	1	161,82	154
4656-18-1320	7314150387175	1	296,68	154
4656-18-340	7314150387144	1	85,78	154
4656-18-540	7314150387151	1	102,50	154
4656-18-940	7314150387168	1	156,44	154
4656-20-1320	7314150387212	1	350,62	154
4656-20-320	7314150387182	1	80,92	154
4656-20-520	7314150387199	1	104,65	154
4656-20-920	7314150387205	1	148,88	154
4656-22-1320	7314150387250	1	377,60	154
4656-22-320	7314150387229	1	99,25	154
4656-22-520	7314150387236	1	118,67	154
4656-22-920	7314150387243	1	161,82	154
4656-24-320	7314150387267	1	96,03	154
4656-24-520	7314150387274	1	118,67	154
4656-25-1320	7314150387311	1	408,89	154
4656-25-320	7314150387281	1	105,73	154
4656-25-520	7314150387298	1	129,46	154
4656-25-920	7314150387304	1	192,03	154
4656-26-520	7314150387328	1	129,46	154
4656-28-370	7314150387434	1	127,30	154
4656-28-570	7314150387458	1	139,17	154
4656-28-670	7314150387489	1	175,85	154
4656-28-920	7314150387526	1	210,38	154
4656-30-370	7314150387540	1	139,17	154
4656-30-570	7314150387571	1	148,88	154
4656-32-1320	7314150387649	1	420,74	154
4656-32-370	7314150387595	1	145,65	154
4656-32-570	7314150387618	1	181,25	154
4656-32-920	7314150387632	1	247,06	154
4656-35-370	7314150387656	1	160,75	154
4656-35-570	7314150387663	1	193,11	154
4656-35-670	7314150387670	1	226,56	154
4656-37-370	7314150387687	1	161,82	154
4656-37-570	7314150387694	1	193,11	154
4656-37-920	7314150387700	1	291,28	154
4656-38-370	7314150387717	1	280,50	154
4656-38-570	7314150387724	1	193,11	154
4656-40-1320	7314150387762	1	507,06	154
4656-40-370	7314150387731	1	188,80	154
4656-40-570	7314150387748	1	231,96	154
4656-40-920	7314150387755	1	302,08	154
4656-45-570	7314150387779	1	312,86	154
4656-45-920	7314150387786	1	430,46	154
4656-50-570	7314150387793	1	377,60	154
4656-52-570	7314150387809	1	442,32	154
4659-FLAT -28	7314150387922	1	17,81	156
4659-FLAT -40	7314150387939	1	20,61	156
4659-FLAT -60	7314150387946	1	26,76	156
4659-POINT-28	7314150387892	1	17,26	156
4659-POINT-40	7314150387908	1	20,61	156
4659-POINT-60	7314150387915	1	27,84	156
4659-TILE-30-5	7314150388042	1	48,77	156
4659-TILE-30-8	7314150388059	1	51,25	156
4659-WIDE-30-8	7314150387953	1	46,17	156
4659-WIDE-36-5	7314150387984	1	30,76	156
466-1000	7314150128327	4	49,55	527
466-1000-M	7314150186105	4	61,40	527
466-1200	7314150128334	4	59,99	527
466-1200-M	7314150186129	4	73,07	527
466-1800	7314150128341	4	77,36	527
466-2000	7314150129836	4	94,37	527
466-250	7314150128655	10	30,12	529
466-400	7314150128297	4	33,57	527
466-400-M	7314150128358	4	42,19	527
466-600	7314150128303	4	40,86	527
466-600-M	7314150128365	4	49,56	527
466-800	7314150128310	4	44,32	527
466-800-M	7314150186082	4	53,56	527
466-BE1	7314150215218	12	6,62	529
466-LINE	7314150215249	12	5,50	529
466-POST	7314150215232	6	9,29	529
4724-JT	7311518265847	1	18,16	621
4728-JT	7311518265854	1	18,76	621
474-125-0.60	7311518029050	10	10,16	537
474-125-0.80	7311518029869	10	10,31	537
474-150-0.60	7311518029876	10	10,66	537
474-150-0.80	7311518029883	10	10,84	537
4750-2PP-1	7314153014733	1	39,97	455
4750-3PB-1	7314153014719	1	89,34	454
4750-3PB-2	7314150187782	1	133,21	460
4750-BWC-1	7314153018809	1	24,30	456
4750-DHO-3	7314150289530	1	32,67	455
4750-EP-1	7314153014726	1	52,35	456
4750-FOLTC-1	7314153019271	1	148,88	454
4750-HDB-2	7314150289486	1	51,58	455
4750-HDBS-2	7314150289479	1	143,28	455
4750-HDLB-1	7314153014757	1	36,86	455
4750-HDLB-TAH	7314150303892	1	63,43	460
4750-HHO-2	7314153014863	1	22,11	460
4750-JU3PB-1	7314153015747	1	32,86	455
4750-KNHO-1	7314153015839	1	16,44	456
4750-KP-1	7314153014771	1	45,76	456
4750-LV-1	7314150358052	1	10,11	453
4750-LV-2	7314150393800	1	10,11	453
4750-MPH-1	7314150291625	1	24,37	456

\* Hasta agotar existencias



4750-MTHO-TAH	7314150319589	1	15,58	460
4750-QRFB-1	7314150289455	1	21,21	455
4750-ROCO-1	7314153015273	1	20,72	456
4750-TOCST-1	7314153018779	1	56,42	454
4750-UP-2	7314150187768	1	62,61	460
4750-VDEC	7314150222377	1	197,96	454
4750-VMPH-1	7314153014818	1	17,67	456
4750ALC01FF1	7314150508884	1	832,81	429
4750BMC10	7314150264032	1	23,10	449
4750BMC10FF1	7314150500673	1	509,23	450
4750BMC3	7314150359639	1	5,21	449
4750BMC4	7314150426256	1	9,38	449
4750BMC5	7314150264001	1	12,76	449
4750BMC5.5	7314150326167	1	14,16	449
4750BMC7	7314150277605	1	16,90	449
4750BMC9	7314150264025	1	17,26	449
4750BMC11	7314150541294	1	27,58	127
4750FB1-19A	7314150277612	1	70,50	452
4750FB1-19B	7314150277629	4	97,52	452
4750FB2-19A	7314150277636	4	61,09	452
4750FB2-19TS001	7314150302772	1	577,50	450
4750FB2-24A	7314150277643	2	88,12	452
4750FB2W-24A	7314150277650	1	173,88	453
4750FB2W-TS001	7314150302765	1	690,39	450
4750FB3-12	7314150277667	1	72,11	453
4750FB4-18	7314150277674	4	105,74	453
4750FB4-18TS001	7314150302758	1	767,65	450
4750FB5-FG1	7314150401796	1	18,36	454
4750FB5-FG2	7314150401819	1	20,52	454
4750FB5A	7314150277704	1	10,57	453
4750FB5ATS001	7314150302727	1	135,71	451
4750FB5B	7314150277698	1	18,21	453
4750FB5BFF1	7314150302734	1	200,62	451
4750FB5C	7314150277681	8	22,91	453
4750FB6-13	7314150393091	1	16,91	453
4750FB6-19	7314150393114	1	22,55	453
4750FB7-01	7314150465668	60	22,68	454
4750FB7-02	7314150465675	60	27,00	454
4750FB7ORBG	7314150465682	120	9,18	455
4750FB7ORLT	7314150465699	120	8,10	455
4750FB8	7314150465651	4	96,12	452
4750PTB50	7314150275007	3	49,59	449
4750PTB60	7314150275014	3	57,04	449
4750PTB65	7314150345809	2	64,04	449
4750PTB65TS5	7314150456260	1	230,13	449
4750PTBW47	7314150275021	1	80,61	449
4750PTBW67	7314150289189	1	101,69	449
4750RC01	7314150220151	1	223,38	430
4750RCHD-AC1	7314150229857	1	39,11	431
4750RCHD00*	7314150271603	1	228,79	430
4750RCHD01*	7314150227426	1	290,00	430
4750RCHD011	7314150229802	1	472,10	430
4750RCHD01AC1	7314150229819	1	53,95	431
4750RCHD01AC2	7314150229826	1	128,15	431
4750RCHD01FF1	7314150247578	1	2.832,35	428
4750RCHD01FF2	7314150227433	1	335,19	430
4750RCHD01FF3	7314150229833	1	53,95	431
4750RCHD01FF4	7314150229840	1	128,15	431
4750RCHD01FF9	7314150247561	1	4.274,90	427
4750RCHD01RED	7314150249183	1	3.089,35	427
4750RCHD02	7314150249190	1	2.751,16	428
4750RCHD02FF1	7314150309580	1	1.933,21	428
4750RCHD02FF2	7314150345533	1	2.919,89	428
4750RCHD02FF4	7314150407538	1	335,19	430
4750RCHD02FF15	7314150227440	1	526,07	430
4750RCHD02RF1V	7314150267422	1	2.566,81	426
4750RCWD-AC1	7314150347698	1	3.771,53	427
4750RCWD-AC2	7314150306787	1	2.891,35	426
4750RCWD-AC3	7314150309559	1	4.078,11	427
4750RCWD-AC4	7314150407545	1	526,07	430
4750RCWD4	7314150422081	1	3.127,39	425
4750RCWD4FF1	7314150277179	1	82,62	430
479-08	7314150277186	1	76,26	430
479-12	7314150277193	1	76,26	431
479-16	7314150277209	1	57,21	431
479-24	7314150277124	1	800,80	430
479F-08	7314150302413	1	2.249,20	425
479F-12	7311518025441	6	18,89	579
479F-16	7311518025458	6	20,15	579
479F-20	7311518025465	6	23,07	579
479F-24	7314150319862	6	24,70	579
479F-32	7311518025472	6	26,42	579
480-08	7311518025489	6	28,53	579
480-10	7314150441952	6	21,86	579
480-12	7314150441976	6	23,19	579
480-14	7314150441983	6	26,53	579
480-18	7314150441990	6	28,41	579
480-20	7314150442003	6	30,39	579
480-24	7314150442010	6	32,81	579
480-28	7311518025496	4	23,74	580
480-32	7311518025502	6	25,67	580
480-36	7311518025519	6	27,74	580
480-40	7311518025526	6	37,90	580
481-100	7314150319763	4	31,20	580
481-1000	7311518005030	6	12,75	579
	7311518005092	6	31,44	579





# 481-1500



481-1500	7311518025533	6	42,92	579
481-200	7311518005047	6	14,31	579
481-2000	7314150319855	6	63,18	579
481-300	7311518005054	6	16,87	579
481-400	7311518005061	6	18,64	579
481-500	7311518005078	6	21,44	579
481-800	7311518025540	6	28,60	579
481F-100	7314150442072	6	14,67	579
481F-1000	7314150442133	6	36,14	579
481F-1500	7314150442140	4	49,36	579
481F-200	7314150442089	4	16,45	579
481F-2000	7314150442157	4	72,67	579
481F-300	7314150442096	6	19,41	579
481F-400	7314150442102	6	21,44	579
481F-500	7314150442119	6	24,66	579
481F-800	7314150442126	6	32,90	579
482-25	7311518025557	6	16,56	579
482-28	7311518025564	6	18,04	579
482-30	7311518025571	6	20,96	579
482-35	7311518025595	6	24,62	579
482-40	7311518025601	6	27,30	579
482-45	7311518027551	6	28,57	579
482F-25	7314150442225	4	19,06	579
482F-28	7314150442232	4	20,74	579
482F-30	7314150442249	6	24,11	579
482F-35	7314150442256	4	28,31	579
482F-40	7314150442263	2	31,38	579
482F-45	7314150442270	4	32,85	579
483-16	7311518024314	6	10,23	580
483-20	7311518024321	6	11,38	580
483-22	7311518005108	6	12,32	580
483-25	7311518005115	6	13,88	580
483-28	7311518024284	6	15,43	580
4830	7314150100057	3	44,03	245
4831	7314150103393	3	46,82	245
4833	7314150100064	3	48,41	247
483F-16	7314150442164	6	11,76	580
483F-20	7314150442171	6	13,09	580
483F-22	7314150442188	6	14,17	580
483F-25	7314150442195	6	15,97	580
483F-28	7314150442201	6	17,74	580
483F-30	7314150442218	4	19,37	580
484-1000	7311518005122	6	31,39	580
484-1250	7311518005139	6	35,51	580
484-1500	7311518005146	6	40,18	580
484-2000	7311518024338	4	44,27	580
484F-1000	7314150442027	6	36,10	580
484F-1250	7314150442034	6	40,84	580
484F-1500	7314150442041	6	46,21	580
484F-2000	7314150442058	4	50,90	580
485	7311518005153	6	32,31	580
485W-650	7314150319770	6	29,60	580
485W-750	7314150319787	6	31,39	580
486	7311518005160	4	31,17	581
486-1800	7314150315307	5	60,61	529
486-1800WH	7314150315338	5	60,61	529
486-2000	7314150315314	5	66,46	529
486-2000WH	7314150315345	5	66,46	529
486-2400	7314150315321	5	78,00	529
486-2400WH	7314150315352	5	78,00	529
486-700*	7314150338078	6	23,61	581
486F-700*	7314150338085	6	30,25	581
486W-500	7314150319794	4	23,74	581
486W-600	7314150319800	4	24,46	581
488-2000	7314150337972	2	36,28	581
488-3000	7314150337989	2	43,86	581
488-4000	7314150337996	2	50,83	581
488-5000	7314150338009	2	60,80	581
488-6000	7314150338016	1	66,82	581
488F-2000	7314150338023	2	40,86	581
488F-3000	7314150338030	2	47,68	581
488F-4000	7314150338047	2	53,97	581
488F-5000	7314150338054	4	64,08	581
488F-6000	7314150338061	2	69,55	581
489-1100	7314150133055	8	114,41	583
489-1800	7314150133062	8	114,77	583
489-2700	7314150133079	4	215,30	583
489-3600	7314150133086	4	256,47	583
489-4500	7314150133093	4	277,74	583
489-5400	7314150133109	4	308,95	583
490-3.5*	7311518025373	4	22,89	580
491-3000	7314150345199	4	38,00	583
491-4000	7314150345205	4	42,31	583
491-5000	7314150345212	4	50,01	583
491-6000	7314150345229	4	55,28	583
492-3.5*	7311518025380	6	29,34	580
493-500*	7314150338139	6	23,57	582
493-600*	7314150338146	6	25,28	582
493F-500*	7314150338153	6	28,26	582
493F-600*	7314150338160	1	30,75	582
494-600	7311518025397	6	32,15	582
495-500*	7314150338191	6	24,05	582
495-600*	7314150338207	6	25,07	582
495F-500*	7314150338184	6	27,52	582
495F-600*	7314150338177	1	30,25	582
496-1500	7314150315147	5	75,62	529



496-1800	7314150315154	5	88,24	529
496-SPARE	7314150329304	1	7,68	530
4M-10-11	7314151829438	10	11,53	55
4M-12-13	7314151829445	10	12,60	55
4M-14-15	7314151829476	10	13,81	55
4M-16-17	7314151829490	10	14,85	55
4M-17-19	7314151829506	10	15,44	55
4M-18-19	7314151829513	10	15,44	55
4M-20-22	7314151829520	10	17,83	55
4M-21-23	7314150205363	5	19,53	55
4M-24-26	7314150205370	1	21,91	55
4M-24-27	7314151829551	1	21,91	55
4M-25-28	7314150205387	1	24,75	55
4M-27-29	7314150205394	1	29,69	55
4M-30-32	7314151829575	1	31,21	55
4M-6-7	7314151829407	10	10,04	55
4M-8-9	7314151829414	10	10,37	55
4M/10C	7314150212972	1	165,83	55
4M/10T	7314151829605	1	184,19	55
4M/12C	7314150212989	1	222,66	56
4M/8	7314150180493	1	123,78	56
5-600-21-D-1P	7311518189341	10	141,07	36
5-610-21-D-1P	7311518189358	5	139,96	36
5-630-21-D-1P	7311518189365	1	99,94	36
5-670-21-D-1P*	7311518189389	1	148,40	36
500-12	7314150390977	1	124,15	274
500-14	7314150414505	1	133,10	274
500-15	7314150390984	1	137,23	274
500-16	7314150414512	1	143,76	274
500-18	7314150414543	1	169,26	274
500-22	7314150414567	1	193,96	274
502	7311518130589	25	10,33	554
502-SET2	7311518130664	35	5,99	554
502-SET6	7311518130633	10	26,84	554
5050	7314151083359	1	104,09	354
51-12	7311518044565	10	3,69	619
51-21	7311518003906	10	4,97	619
51-24	7311518003913	10	5,31	619
51-30	7311518003920	10	5,95	619
51-32	7311518003937	10	6,18	619
51-36	7311518003944	10	6,42	619
510031	7314150216338	5	38,14	221
510033	7314150216345	5	25,14	221
510034	7314150216314	10	17,89	221
5124-JS-H	7311518219352	4	23,50	620
5128-JS-H	7311518219369	4	28,21	620
52	7311518276027	12	4,46	304
5226 DC*	7314150120352	1	56,39	252
527 D-160	7314150032723	5	27,21	240
527 D-200	7314150032730	5	32,51	240
527 GC-160	7314150205653	3	33,92	240
527 GC-200	7314150205660	3	40,50	240
527V-160	7314150126811	2	50,20	487
527V-200	7314150126828	2	55,07	487
528-700	7311518188993	1	49,98	561
528-COM	7311518188986	1	41,82	561
529-16-L	7314150198139	4	39,80	578
529-16-XL	7314150198146	4	41,94	578
529-20-L	7314150198160	4	41,94	578
529-20-XL*	7314150198153	4	44,06	578
529S-16-XL	7314150340330	4	40,92	578
529S-20-XL	7314150340347	4	42,99	578
541 D-150	7314150032754	5	17,12	240
541 D-200	7314150032761	5	19,46	240
541 D-250	7314150032778	5	25,51	240
5418	7314151084370	1	48,19	523
5419/6T	7314151821562	1	56,34	523
541D-180	7314150127160	5	18,34	240
541D-225	7314150127290	5	22,42	240
5463 R	7314151085063	5	58,67	522
5463-120	7314151085001	5	35,05	522
54640	7314150215720	1	20,17	176
5465 AMT	7314151085148	5	58,67	520
5468-112	7314151085247	5	26,84	520
5469 B	7314151085322	5	25,19	520
5469 BI	7314151085346	5	26,97	520
5469 I	7314151085407	5	29,30	520
5469 R	7314151085421	5	40,61	520
5469-127	7314151085285	5	26,08	520
5471 F-120	7314151085681	5	21,54	520
5471 F-145	7314151085704	5	23,34	520
5471 F-200	7314151085728	5	47,39	520
5471 F-250	7314151085742	5	60,59	520
5471 F-300	7314151085766	5	83,30	520
5471 FI-120	7314151085780	5	22,68	520
5471 FI-200	7314151085827	5	45,62	520
5471 FR-120	7314151085889	5	37,09	520
5471 FR-145	7314151085902	5	42,08	520
5475 K	7314151086244	5	28,07	520
5475 R	7314151086268	5	50,95	520
5476 H	7314151086305	5	65,88	522
5488 AM	7314151821166	5	43,02	521
5490 AM	7314151821180	5	43,02	521
5493-115	7314151821234	5	68,50	522
5515B	7314151086978	25	26,51	354
5515FL	7314150504077	10	39,19	354



5515FUV	7314150540143	1	52,07	354
5515GV	7314151481483	1	36,79	354
5515L	7314151481568	1	27,97	355
5515M	7314151086985	1	36,66	355
5515T	7314151589172	25	32,38	355
5515T-52	73141553021939	25	13,77	354
5516	7314151086992	5	24,75	520
5516 I	7314151087029	5	27,15	520
5517	7314151573843	5	28,61	520
5517 I	7314151573928	5	28,05	520
5518	7314151087043	5	31,26	520
5521	7314150215713	1	54,73	176
5540 AM	7314151821319	5	43,02	520
5541 AM	7314151821326	5	43,02	520
5544 AM	7314151821357	5	43,02	521
5545 AM	7314151821364	5	43,02	521
5546 AM	7314151821371	5	43,02	521
5547 AM	7314151821388	5	43,02	521
5549 AM	7314151821401	5	43,02	521
5550-3.2	7314151475673	10	19,32	523
5550-4.5	7314151475758	10	21,76	523
5552*	7314151378554	1	20,21	523
5553*	7314151378639	1	20,21	523
5554*	7314151378714	1	20,21	523
5578-115	7314151547769	5	46,56	521
5579-115	7314151547844	5	46,56	521
5588 AM	7314151821432	5	43,02	521
5589 AM	7314151821449	5	43,02	521
5590 AM	7314151821456	5	43,02	521
5600/4*	7314151436773	1	94,41	524
5724-JS	7311518216085	1	16,45	621
5728-JS	7311518216092	1	19,75	621
5750	7311518280949	1	18,85	338
5770	7314150504466	12	76,02	338
59/S100BC	7314150337637	1	46,61	174
59/S100BC-IP	7314150337644	8	46,61	174
59/S10BC	7314150413003	1	4,66	172
59/S28-4	7314151847173	1	120,85	173
59/S31B	7314150325788	6	16,18	173
59/S31B-IP	7314150325795	12	15,86	173
59/S35BC	7314150412990	1	66,28	174
59/S36BCR	7314150413232	6	56,17	217
59/S54BC	7314150337613	20	35,60	174
59/S54BC-IP	7314150337620	8	35,60	174
59S/0.5-3.0-3P	7314150259205	50	3,92	167
59S/0.5-4.0	7314150199822	1	13,06	167
59S/0.5-4.0-3P	7314150259212	50	3,92	167
59S/0.6-3.5	7314150199839	1	13,06	167
59S/0.6-3.5-3P	7314150259229	50	3,92	167
59S/0.6-4.5	7314150199801	1	13,06	167
59S/0.6-4.5-3P	7314150201600	1	3,92	167
59S/0.8-5.5	7314150199849	1	13,06	167
59S/0.8-5.5-3P	7314150201624	1	3,92	167
59S/1.0-5.5	7314150199863	1	13,06	167
59S/1.0-5.5-3P	7314150259293	50	3,92	167
59S/1.2-6.5	7314150199887	1	13,06	167
59S/1.2-6.5-3P	7314150258970	50	3,92	167
59S/1.2-8.0	7314150199890	1	21,22	167
59S/1.2-8.0-3P	7314150258987	1	6,38	167
59S/1.6-10	7314150199846	1	21,22	167
59S/1.6-10-3P	7314150259236	50	6,38	167
59S/1.6-9.0	7314150199853	1	21,22	167
59S/1.6-9.0-3P	7314150259243	50	6,38	167
59S/125PH1-2P	7314150260553	25	14,15	171
59S/125PH2-2P	7314150260560	25	14,15	171
59S/125PH2-IP	7314150342433	100	2,66	171
59S/125PH2COMBI-2P	7314150531530	40	16,87	171
59S/125PH3	7314150204304	1	35,39	171
59S/125PH3-2P	7314150260577	25	14,15	171
59S/125PZ1	7314150200733	1	35,39	171
59S/125PZ1-2P	7314150260522	25	14,15	171
59S/125PZ2	7314150200740	1	35,39	171
59S/125PZ2-2P	7314150260539	25	14,15	171
59S/125PZ3	7314150200757	1	35,39	171
59S/125PZ3-2P	7314150260546	25	14,15	171
59S/150T15	7314150200764	1	53,08	171
59S/150T15-2P	7314150260584	1	21,23	171
59S/150T20-2P	7314150260591	1	21,23	171
59S/150T25-2P	7314150260607	1	21,23	171
59S/150T30-2P	7314150260614	1	21,23	171
59S/17-1	7314150191499	1	22,34	172
59S/17-2	7314150191505	1	23,35	173
59S/17-3*	7314150191512	1	22,65	173
59S/22-1	7314150204229	12	31,69	173
59S/22-2	7314150204236	12	31,69	173
59S/31-1	7314150191451	12	24,76	174
59S/31-2	7314150191468	1	25,46	174
59S/50/0.6-3.5-5P	7314150531554	50	17,69	169
59S/50/0.8-4.0-5P	7314150531578	50	17,69	169
59S/50/0.8-5.5-5P	7314150531592	50	17,69	169
59S/50/1.0-6.0-5P	7314150531615	50	17,69	169
59S/50/1.2-6.5-5P	7314150531639	50	17,69	169
59S/50/3.5-2P	7314150260027	50	7,08	169
59S/50/4.0-2P	7314150260041	50	7,08	169
59S/50/5.5-2P	7314150260065	50	7,08	169
59S/50/6.0-2P	7314150260089	1	7,08	169

\* Hasta agotar existencias



59S/50/6.5-2P	7314150260102	50	7,08	169
59S/50H1/16	7314150248926	1	21,09	170
59S/50H1/4	7314150249015	1	21,09	170
59S/50H1/8	7314150248964	1	21,09	170
59S/50H2	7314150200160	1	21,77	170
59S/50H2-2P	7314150259298	50	5,44	170
59S/50H2.5-2P	7314150259304	50	5,44	170
59S/50H2.5-5P	7314150531653	50	9,01	170
59S/50H3-2P	7314150259335	50	5,44	170
59S/50H3-5P	7314150531677	50	21,78	170
59S/50H3/16	7314150248995	1	21,09	170
59S/50H3/32	7314150248940	1	21,09	170
59S/50H3/8	7314150249039	1	21,09	170
59S/50H4-2P	7314150259359	50	5,44	170
59S/50H4-5P	7314150531691	50	9,01	170
59S/50H5-2P	7314150259373	50	5,44	170
59S/50H5-5P	7314150531714	50	9,01	170
59S/50H5/16	7314150249022	1	21,09	170
59S/50H5/32	7314150248988	1	21,09	170
59S/50H5/64	7314150248933	1	21,09	170
59S/50H6-2P	7314150259397	50	5,44	170
59S/50H6-5P	7314150531738	50	21,78	170
59S/50H7/32	7314150249008	1	21,09	170
59S/50H7/64	7314150248957	1	21,09	170
59S/50H8-2P	7314150259410	50	5,44	170
59S/50H8-5P	7314150531752	50	21,77	170
59S/50PH1-2P	7314150203642	1	7,09	169
59S/50PH1-5P	7314150531776	50	14,29	169
59S/50PH2-2P	7314150203758	1	7,09	169
59S/50PH2-5P	7314150531790	50	9,01	169
59S/50PH3-2P	7314150203802	1	7,09	169
59S/50PH3-5P	7314150531813	50	14,30	169
59S/50PZ1-2P	7314150204007	1	7,09	170
59S/50PZ1-5P	7314150531837	50	14,29	170
59S/50PZ2-2P	7314150204014	1	7,09	170
59S/50PZ2-5P	7314150531851	50	14,30	170
59S/50PZ3-2P	7314150204021	1	7,09	170
59S/50PZ3-5P	7314150531875	50	14,30	170
59S/50R1	7314150200238	1	28,57	170
59S/50R1-2P	7314150259441	50	11,44	170
59S/50R2	7314150200245	1	28,57	170
59S/50R2-2P	7314150259472	50	11,44	170
59S/50R3	7314150200252	1	28,57	170
59S/50R3-2P	7314150259502	50	11,44	170
59S/50T10-2P	7314150201723	1	10,07	170
59S/50T10-5P	7314150531899	50	19,06	170
59S/50T15-2P	7314150201730	1	10,07	170
59S/50T15-5P	7314150531912	50	19,06	170
59S/50T20-2P	7314150201747	1	10,07	170
59S/50T20-5P	7314150531936	50	9,58	170
59S/50T25-2P	7314150201754	1	10,07	170
59S/50T25-5P	7314150531950	50	19,06	170
59S/50T27	7314150200139	1	19,04	170
59S/50T30-2P	7314150201761	1	10,07	170
59S/50T30-5P	7314150531974	50	19,06	170
59S/50T40-2P	7314150259281	50	10,07	170
59S/50T40-5P	7314150531998	50	19,06	170
59S/50T8	7314150200085	1	19,04	170
59S/50T8-2P	7314150262809	50	10,07	170
59S/60PEN/DISP*	7314150459032	1	189,84	175
59S/7-1*	7314150191536	1	12,76	172
59S/7-2	7314150191543	1	13,47	172
59S/7-3	7314150191550	1	23,89	172
59S/7-4	7314150191567	1	13,95	172
59S/70PH1-2P	7314150259526	1	9,53	170
59S/70PH1-5P	7314150532018	25	23,81	170
59S/70PH2-2P	7314150259557	25	9,53	170
59S/70PH2-5P	7314150532032	25	23,81	170
59S/70PZ1-2P	7314150259564	1	9,53	170
59S/70PZ1-5P	7314150532056	25	23,81	170
59S/70PZ2-2P	7314150260331	1	9,53	170
59S/70PZ2-5P	7314150532070	25	23,81	170
59S/70PZ3	7314150200306	1	23,81	170
59S/70PZ3-2P	7314150260348	1	9,53	170
59S/70T10-2P	7314150260355	1	11,44	171
59S/70T10-5P	7314150532094	25	28,57	171
59S/70T15-2P	7314150260362	25	11,44	171
59S/70T15-5P	7314150532117	25	28,57	171
59S/70T20-2P	7314150201839	25	11,44	171
59S/70T20-5P	7314150532131	25	28,57	171
59S/70T25-2P	7314150260379	25	11,44	171
59S/70T25-5P	7314150532155	25	28,57	171
59S/70T27	7314150200597	1	28,57	171
59S/70T27-2P	7314150260386	1	11,44	171
59S/70T30-2P	7314150260393	1	11,44	171
59S/70T30-5P	7314150532179	25	28,57	171
59S/70T40-2P	7314150260409	1	11,44	171
59S/70T40-5P	7314150532193	25	28,57	171
59S/70TR15	7314150200627	1	42,18	171
59S/70TR15-2P	7314150260416	1	16,86	171
59S/70TR20	7314150200634	1	42,18	171
59S/70TR20-2P	7314150260423	25	16,86	171
59S/70TR25	7314150200641	1	42,18	171
59S/70TR25-2P	7314150260430	25	16,86	171
59S/70TR27	7314150200658	1	42,18	171
59S/70TR27-2P	7314150260447	25	16,86	171



# 59S/70TR30



59S/70TR30	7314150200665	1	42,18	171
59S/70TR30-2P	7314150260454	25	16,86	171
59S/70TR40	7314150200672	1	42,18	171
59S/70TR40-2P	7314150260461	25	16,86	171
59S/H1.5-3P	7314150258994	50	8,17	168
59S/H1.5-5P	7314150532216	50	13,59	168
59S/H1/16-3P	7314150259021	50	8,17	169
59S/H1/16-5P	7314150532230	50	13,59	169
59S/H1/4	7314150199266	1	13,59	169
59S/H1/4-3P	7314150259120	50	8,17	169
59S/H1/8-3P	7314150259069	50	8,17	169
59S/H1/8-5P	7314150532254	50	13,59	169
59S/H10-3P	7311518333638	25	10,62	168
59S/H10-5P	7314150532278	50	17,69	168
59S/H2	7314150198955	1	13,59	168
59S/H2-3P	7314150259007	50	8,17	168
59S/H2.5-3P	7314150259014	50	8,17	168
59S/H2.5-5P	7314150532315	50	13,59	168
59S/H3-3P	7314150201662	1	9,82	168
59S/H3-5P	7314150532339	50	13,59	168
59S/H3/16-5P	7314150532353	50	13,59	169
59S/H3/32-3P	7314150259045	50	8,17	169
59S/H3/32-5P	7314150532377	50	13,59	169
59S/H3/8	7314150204212	1	8,17	169
59S/H3/8-3P	7314150259144	25	10,62	169
59S/H3BALL	7314150200689	1	42,18	171
59S/H3BALL-2P	7314150260478	1	16,86	171
59S/H4-3P	7314150201679	1	9,82	168
59S/H4-5P	7314150532391	50	13,59	168
59S/H4-IPB	7314150225767	500	0,64	168
59S/H4BALL-2P	7314150260485	1	16,86	171
59S/H5-3P	7314150201686	1	9,82	168
59S/H5-5P	7314150532414	50	13,59	168
59S/H5/16-3P	7314150259137	50	8,17	169
59S/H5/16-5P	7314150532438	50	13,59	169
59S/H5/32-3P	7314150259083	50	8,17	169
59S/H5/32-5P	7314150532452	50	13,59	169
59S/H5/64-3P	7314150259038	50	8,17	169
59S/H5/64-5P	7314150532476	50	13,59	169
59S/H5BALL	7314150200702	1	42,18	171
59S/H5BALL-2P	7314150260492	1	16,86	171
59S/H6-3P	7314150201693	1	9,82	168
59S/H6-5P	7314150532490	50	13,59	168
59S/H6BALL	7314150200719	1	42,18	171
59S/H6BALL-2P	7314150260508	1	16,86	171
59S/H7/32-3P	7314150259113	50	8,17	169
59S/H7/32-5P	7314150532513	50	13,59	169
59S/H7/64-3P	7314150259052	50	8,17	169
59S/H7/64-5P	7314150532537	50	13,59	169
59S/H8-3P	7314150201709	50	10,62	168
59S/H8-5P	7314150532551	50	17,69	168
59S/H8BALL	7314150200726	1	42,18	171
59S/H8BALL-2P	7314150260515	1	16,86	171
59S/HBALL-3P	7314150201716	1	25,25	171
59S/M3	7314150199730	1	35,39	169
59S/M3-3P	7314150259151	50	10,62	169
59S/M4	7314150199754	1	35,39	169
59S/M4-3P	7314150259168	50	10,62	169
59S/M5	7314150199778	1	35,39	169
59S/M5-3P	7314150259175	50	10,62	169
59S/M6	7314150199792	1	35,39	169
59S/M6-3P	7314150259182	50	10,62	169
59S/M8	7314150199808	1	39,46	169
59S/M8-3P	7314150259199	50	11,83	169
59S/PH0	7314150198177	1	6,82	167
59S/PH0-3P	7314150258819	50	2,62	167
59S/PH1-10P	7314150532575	50	6,82	167
59S/PH1-30P	7314150200801	1	19,12	167
59S/PH1-3P	7314150201396	1	3,41	167
59S/PH1-IP	7314150206780	100	0,54	167
59S/PH1-IPB	7314150225743	500	0,48	167
59S/PH1COMBI-2P	7314150215669	1	16,86	171
59S/PH2-10P	7314150532599	50	6,82	167
59S/PH2-30P	7314150200818	1	19,12	167
59S/PH2-3P	7314150201402	1	3,41	167
59S/PH2-IP	7314150206797	100	0,54	167
59S/PH2-IPB	7314150204038	500	0,48	167
59S/PH2G-10P	7314150532612	50	13,35	168
59S/PH2G-30P	7314150200832	1	36,50	168
59S/PH2G-3P	7314150259250	50	4,00	168
59S/PH2PEN*	7314150458950	10	3,16	175
59S/PH3-10P	7314150532636	50	6,82	167
59S/PH3-30P	7314150200825	1	19,12	167
59S/PH3-3P	7314150201419	1	3,41	167
59S/PH3-IPB	7314150225750	500	0,48	167
59S/PH3COMBI-2P	7314150203611	1	16,86	171
59S/PH4	7314150198368	1	13,85	167
59S/PH4-3P	7314150258826	25	4,45	167
59S/PZ0-3P	7314150258833	50	2,62	168
59S/PZ1-10P	7314150532650	50	6,82	168
59S/PZ1-30P	7314150200849	1	19,12	168
59S/PZ1-3P	7314150201426	1	3,41	168
59S/PZ1-IP	7314150206803	100	0,63	168
59S/PZ1-IPB	7314150204373	500	0,48	168
59S/PZ2-10P	7314150532674	50	6,82	168
59S/PZ2-30P	7314150200856	1	19,12	168



59S/PZ2-3P	7314150201433	1	3,41	168
59S/PZ2-IP	7314150206810	100	0,54	168
59S/PZ2-IPB	7314150204380	500	0,48	168
59S/PZ2PEN*	7314150458974	10	3,16	175
59S/PZ3-10P	7314150532698	50	6,82	168
59S/PZ3-30P	7314150200863	1	19,12	168
59S/PZ3-3P	7314150201440	1	3,41	168
59S/PZ3-IPB	7314150225736	500	0,48	168
59S/PZ4	7314150198436	1	13,85	168
59S/R1	7314150199310	1	29,94	169
59S/R1-3P	7314150201631	1	11,99	169
59S/R2-3P	7314150201648	1	11,99	169
59S/R3	7314150199365	1	29,94	169
59S/R3-3P	7314150201655	1	11,99	169
59S/R4	7314150232109	1	29,94	169
59S/T10-10P	7314150532711	50	11,43	168
59S/T10-30P	7314150200870	1	31,84	168
59S/T10-3P	7314150201457	1	5,72	168
59S/T10CS	7314150444014	20	9,27	168
59S/T15-10P	7314150532759	50	10,30	168
59S/T15-30P	7314150200887	1	31,84	168
59S/T15-3P	7314150201464	1	5,72	168
59S/T15CS	7314150444021	20	9,27	168
59S/T15PEN*	7314150458929	10	3,69	175
59S/T20-10P	7314150532797	50	11,43	168
59S/T20-30P	7314150200894	1	31,84	168
59S/T20-3P	7314150201471	1	5,72	168
59S/T20CS	7314150444038	20	9,27	168
59S/T20PEN*	7314150458936	10	3,69	175
59S/T25-10P	7314150532834	50	11,43	168
59S/T25-30P	7314150200900	1	31,84	168
59S/T25-3P	7314150201488	1	5,72	168
59S/T25CS-10P	7314150532858	50	9,27	168
59S/T25PEN*	7314150458943	10	3,69	175
59S/T27-10P	7314150532872	50	11,43	168
59S/T27-3P	7314150201495	1	5,72	168
59S/T27CS	7314150444052	20	9,27	168
59S/T3	7314150198443	1	9,54	168
59S/T3-3P	7314150258840	50	5,72	168
59S/T30-10P	7314150251988	50	10,30	168
59S/T30-30P	7314150200924	1	35,52	168
59S/T30-3P	7314150201501	1	7,65	168
59S/T30CS	7314150444069	20	30,61	168
59S/T4-3P	7314150258857	50	5,72	168
59S/T40-10P	7314150532933	50	12,75	168
59S/T40-30P	7314150200931	1	35,51	168
59S/T40-3P	7314150201518	1	7,65	168
59S/T40CS	7314150444076	20	30,61	168
59S/T45-3P	7314150258918	50	10,62	168
59S/T45-5P	7314150532971	50	17,69	168
59S/T5	7314150198467	1	9,54	168
59S/T5-3P	7314150258864	50	5,72	168
59S/T50-3P	7314150258925	50	10,62	168
59S/T50-5P	7314150532995	50	17,69	168
59S/T6-3P	7314150258871	50	5,72	168
59S/T7	7314150198498	1	11,44	168
59S/T7-3P	7314150258888	50	5,72	168
59S/T8	7314150198504	1	11,44	168
59S/T8-3P	7314150258895	50	5,72	168
59S/T9	7314150198511	1	11,44	168
59S/T9-3P	7314150258901	50	5,72	168
59S/TCS11-1	7314150444083	10	19,03	172
59S/TR10-3P	7314150201525	1	8,42	168
59S/TR10-5P	7314150533015	50	14,03	168
59S/TR15	7314150198719	1	14,03	168
59S/TR15-3P	7314150201532	1	8,42	168
59S/TR20-3P	7314150201549	1	8,42	168
59S/TR20-5P	7314150533053	50	14,03	168
59S/TR25-3P	7314150201556	1	8,42	168
59S/TR25-5P	7314150533077	50	14,03	168
59S/TR27	7314150198757	1	14,03	168
59S/TR27-3P	7314150201570	1	8,42	168
59S/TR30-3P	7314150201587	1	8,42	168
59S/TR30-5P	7314150533091	50	14,03	168
59S/TR40	7314150198795	1	14,03	168
59S/TR40-3P	7314150201594	1	8,42	168
59S/TR7	7314150198672	1	14,03	168
59S/TR7-3P	7314150258932	50	8,42	168
59S/TR8	7314150198689	1	14,03	168
59S/TR8-3P	7314150258949	50	8,42	168
59S/TR9	7314150198696	1	14,03	168
59S/TR9-3P	7314150258956	50	8,42	168
59S/TS-0	7314150199389	1	37,42	169
59S/TS-1	7314150199396	1	37,42	169
59S/TS-10-5P	7314150533138	50	37,42	169
59S/TS-4-5P	7314150533152	50	37,42	169
59S/TS-5-5P	7314150533176	50	10,30	169
59S/TS-6-5P	7314150533190	50	37,42	169
59S/TS-8-5P	7314150533220	50	37,42	169
59S/TW0	7314150199610	1	34,02	169
59S/TW1	7314150199631	1	34,02	169
59S/TW2	7314150199655	1	34,02	169
59S/TW3	7314150199679	1	34,02	169
59S/TW4	7314150199693	1	34,02	169
59S/TW5	7314150199716	1	34,02	169
6	8412814220048	1	18,14	225



			€	
6-342-06-2-0	7311518021719	10	8,93	32
6-342-06-2-2	7311518244170	5	12,42	32
6-342-08-1-0	7311518021726	10	10,31	32
6-342-08-1-2	7311518028282	5	13,94	32
6-342-08-2-0	7311518021733	10	11,99	32
6-342-08-2-2	7311518005375	5	16,74	32
6-342-10-1-0	7311518021757	10	14,08	32
6-342-10-1-2	7311518005382	5	17,30	32
6-342-10-2-0	7311518021764	10	15,19	32
6-342-10-2-2	7311518005399	5	20,51	32
6-343-08-2-0	7311518021801	10	15,88	32
6-343-08-2-2	7311518001070	5	18,49	32
6-343-08-3-0	7311518021818	10	18,13	32
6-343-10-2-0	7311518021825	10	20,22	32
6-343-10-2-2	7311518001094	5	22,60	32
6-343-10-3-0	7311518021832	10	23,15	32
6-344-08-2-0	7311518021887	10	10,78	32
6-344-08-2-2	7311518005344	5	14,91	32
6-344-10-2-0	7311518021900	10	12,22	32
6-344-10-2-2	7311518005351	5	18,13	32
6-345-08-1-2	7311518028312	5	11,24	33
6-345-08-2-0	7311518021948	10	9,88	32
6-345-08-2-2	7311518005412	5	11,46	33
6-345-10-1-2	7311518005429	5	14,22	33
6-345-10-2-0	7311518021955	10	11,95	32
6-470-08-2-2	7311518242008	5	55,07	33
600-3	7314150124787	1	13,23	214
600.003.010	8412814600000	1	31,26	366
600.005.012	8412814600017	1	40,38	366
601000800	8413345202299	1	246,27	575
601001000	8413345202305	1	328,34	575
601001250	8413345202312	1	452,24	575
601001500	8413345202329	1	642,79	575
6010H0800	8413345015769	1	50,14	576
6010H1000	8413345015776	1	59,65	576
6010H1250	8413345015783	1	81,32	576
6010H1500	8413345015790	1	138,29	576
6010M0800	8413345015806	1	25,56	575
6010M1000	8413345116619	1	26,18	575
6010M1250	8413345015820	1	38,72	575
6010M1500	8413345015837	1	47,39	575
602-4-LA	7314150224357	1	18,64	214
604-5	7314150124800	1	24,77	214
6040M0630	8413345124126	1	21,38	576
605-10-PC-AU	7314150186334	1	57,80	216
605-6	7314150153770	1	30,11	215
606-6	7314150124824	1	29,13	215
6070H1000	8413345030656	1	45,05	575
6070H1250	8413345084833	1	64,12	575
6070H1500	8413345030663	1	114,62	575
6070H1750	8413345030670	1	147,43	575
607201000	8413345030533	1	255,55	575
607201250	8413345030540	1	357,77	575
607201500	8413345030557	1	459,99	575
607201750	8413345030564	1	613,32	575
6072M1000	8413345015813	1	30,52	575
6072M1500	8413345137454	1	47,33	575
6072M1750	8413345030687	1	58,40	575
607/7-1	7314150191529	1	29,75	164
607/7-1	7314150191574	1	18,12	164
607/PH1	7314150199488	1	11,19	163
607/PH2	7314150199495	1	11,19	163
607/PH3	7314150199501	1	11,19	163
607/PZ3	7314150199563	1	11,19	164
607/T15	7314150199662	1	17,39	164
607/T20	7314150199686	1	17,39	164
607/T25	7314150199709	1	17,39	164
607/T27	7314150199723	1	17,39	164
607/T40	7314150199761	1	17,39	164
607/T7	7314150199587	1	17,39	164
607/T9	7314150199624	1	17,39	164
610-6	7314150124848	1	29,96	215
611-10-200	7314150124428	10	10,56	216
611-3-5-100	7314150124336	10	3,36	216
611-3-5-75	7314150124329	10	3,20	216
611-4-100	7314150124350	10	4,27	216
611-4-75	7314150124343	10	3,83	216
611-5-5-100	7314150124367	10	5,10	216
611-5-5-125	7314150124381	10	5,38	216
611-6-5-125	7314150124374	10	6,50	216
611-6-5-150	7314150124398	10	6,81	216
611-6-5-25	7314150124602	10	6,48	216
611-8-150	7314150124404	10	8,26	216
611-8-175	7314150124411	10	8,74	216
612-5	7314150124817	1	29,74	215
613-3-100	7314150124442	10	3,25	216
613-3-75	7314150124435	10	3,19	216
613-3-5-100	7314150124459	10	3,37	216
613-4-100	7314150124466	10	3,78	216
613-4-125	7314150124473	10	4,17	216
613-5-5-150	7314150124497	10	5,58	216
613-6-5-150	7314150124503	10	7,07	216
615-0-75	7314150124558	10	3,50	216
615-1-100	7314150124565	10	5,12	216
615-2-125	7314150124572	10	6,60	216
615-2-25	7314150124596	10	6,48	216

\* Hasta agotar existencias

			€	
615-3-150	7314150124589	10	10,03	216
6151	7314150539185	10	23,68	628
6152	7314150539192	10	24,62	628
6152SS	7314150539215	10	33,89	628
6159	7314150539208	10	28,74	628
616-0-75	7314150124510	10	4,55	216
616-1-100	7314150124527	10	5,51	216
616-2-125	7314150124534	10	7,09	216
616-3-150	7314150124541	10	10,63	216
618-10-75	7314150124619	10	5,30	217
618-15-100	7314150124626	10	5,58	217
618-20-100	7314150124633	10	5,58	217
618-25-125	7314150124640	10	6,48	217
618-27-125	7314150124657	10	6,48	217
618-30-150	7314150124664	10	7,97	217
618-40-150	7314150124671	10	9,05	217
61H/50PH1	7314150200382	1	15,16	164
61H/50PZ1	7314150200412	1	15,16	164
61H/50PZ3	7314150200436	1	15,16	164
61H/50T10	7314150200443	1	19,24	164
61H/50T15	7314150200450	1	19,24	164
61H/50T25	7314150200474	1	19,24	164
61H/PH2	7314150199020	1	11,93	164
61H/PH3	7314150199044	1	5,96	164
61H/PZ3	7314150199105	1	5,96	164
61H/T10	7314150199129	1	18,36	165
61H/T15	7314150199143	1	18,36	165
61H/T20	7314150199167	1	18,36	165
61H/T25	7314150199181	1	18,36	165
61H/T40	7314150199235	1	9,20	165
620-6	7314150128594	1	51,03	485
622-3P	7314150427727	1	94,43	252
6221D	7314150421596	10	21,49	251
6221D IP	7314150440368	10	21,12	251
6222D	7314150421589	10	22,84	251
6222D IP	7314150437702	10	22,43	251
6223D	7314150421558	8	23,34	251
6223D IP	7314150421794	8	22,97	251
6224	7314150421619	4	33,16	251
6224D	7314150421565	5	20,88	251
6224D IP	7314150421800	5	20,48	251
6225D	7314150421572	10	36,86	251
6225D IP	7314150421817	5	36,44	251
623-3-100	7314150128518	10	6,08	485
623-3-5-100	7314150128525	10	6,61	485
623-4-100	7314150128532	10	6,90	485
623-5-5-125	7314150128549	10	9,58	485
623-6-5-150	7314150128556	10	11,41	485
625	7311518221614	5	31,00	536
625-0-100	7314150128563	10	4,24	485
625-1-150	7314150128570	10	7,90	485
625-2-175	7314150128587	10	11,00	485
625-DROP	7311518221638	10	13,70	536
625-PEAR	7311518221621	10	13,70	536
625-ROUND	7311518221645	10	13,70	536
6258	7314150539222	10	28,74	628
62TIN/50PH1	7314150200504	1	22,97	163
62TIN/50PH3	7314150200528	1	22,97	163
62TIN/50PZ1	7314150200535	1	22,97	163
62TIN/50PZ2	7314150200542	1	22,97	163
62TIN/50PZ3	7314150200559	1	22,97	163
62TIN/7-1	7314150203505	1	23,64	163
62TIN/PH1	7314150199259	1	21,13	163
62TIN/PZ1	7314150199327	1	21,13	163
62TIN/PZ2	7314150199334	1	21,13	163
62TIN/PZ3	7314150199358	1	21,13	163
62TIN/T15	7314150199402	1	26,08	163
62TIN/T20	7314150199426	1	26,08	163
62TIN/T25	7314150199440	1	26,08	163
62TIN/T30	7314150199464	1	26,08	163
63D/50PZ1	7314150200320	1	27,33	162
63D/50PZ2	7314150200337	1	27,33	162
63D/50PZ3	7314150200344	1	27,33	162
63D/7-1	7314150191604	1	29,72	162
63D/PH3	7314150198948	1	17,39	162
63D/PZ1	7314150198856	1	17,39	162
63D/PZ2	7314150198870	1	17,39	162
63D/T10	7314150198665	1	19,88	162
63D/T15	7314150198733	1	19,88	162
63D/T40	7314150198832	1	19,88	162
64A/PH1	7314150198481	1	15,40	163
64A/PH3	7314150198573	1	15,40	163
64A/PZ1	7314150198603	1	15,40	163
64A/PZ3	7314150198634	1	15,40	163
650	7311518221591	5	30,30	536
65I/7-1*	7314150204113	1	27,15	517
65I/PH1*	7314150199785	1	28,89	517
65I/PH1-2P*	7314150207985	1	6,82	517
65I/PH2-2P*	7314150201259	1	6,82	517
65I/PH3*	7314150199907	1	28,89	517
65I/PH3-2P*	7314150201266	1	6,82	517
65I/PZ1*	7314150199921	1	28,89	517
65I/PZ1-2P*	7314150201273	1	6,82	517
65I/PZ2-2P*	7314150201280	1	6,82	517
65I/PZ3*	7314150199969	1	28,89	517
65I/PZ3-2P*	7314150201297	1	6,82	517



65I/T15\*



65I/T15*	7314150199990	1	16,52	517
65I/T40*	7314150200078	1	16,52	517
65I/T40-2P*	7314150201358	1	7,51	517
665	7311518221607	5	43,87	536
66IM/10C-1	7314150450732	40	22,77	167
66IM/11C-1	7314150450718	40	18,21	167
66IM/150PH2-2P	7314150550173	40	7,20	166
66IM/150PZ2-2P	7314150550197	40	7,20	166
66IM/150T20C-2P	7314150550210	40	7,20	166
66IM/150T25C-2P	7314150550234	40	7,20	166
66IM/150T30C-2P	7314150550258	40	7,20	166
66IM/150T40C-2P	7314150550272	40	7,20	166
66IM/31C-1	7314150528158	6	29,27	167
66IM/40C-1	7314150548385	10	91,67	167
66IM/50PH1-10P	7314150550470	50	15,44	165
66IM/50PH1-2P	7314150446056	80	4,00	165
66IM/50PH2-10P	7314150550494	50	15,44	165
66IM/50PH2-2P	7314150446063	80	4,00	165
66IM/50PH3-10P	7314150550517	50	15,44	165
66IM/50PH3-2P	7314150446087	80	4,00	165
66IM/50PZ1-10P	7314150550531	50	15,44	165
66IM/50PZ1-2P	7314150446094	80	4,00	165
66IM/50PZ2-10P	7314150550555	50	15,44	165
66IM/50PZ2-2P	7314150446100	80	4,00	165
66IM/50PZ3-10P	7314150550579	50	15,44	165
66IM/50PZ3-2P	7314150446117	80	4,00	165
66IM/50T10C-10P	7314150550593	50	15,44	165
66IM/50T10C-2P	7314150446131	80	4,05	165
66IM/50T15C-10P	7314150550616	50	15,44	165
66IM/50T15C-2P	7314150446148	80	4,05	165
66IM/50T20C-10P	7314150550630	50	15,44	165
66IM/50T20C-2P	7314150446155	80	4,05	165
66IM/50T25C-10P	7314150550654	50	15,44	165
66IM/50T25C-2P	7314150446162	80	4,05	165
66IM/50T27C-10P	7314150550678	50	15,44	165
66IM/50T27C-2P	7314150446179	80	4,05	165
66IM/50T30C-10P	7314150550692	50	15,44	165
66IM/50T30C-2P	7314150446186	80	4,05	165
66IM/50T40C-10P	7314150550715	50	15,44	165
66IM/50T40C-2P	7314150446193	80	4,05	165
66IM/90PH2-2P	7314150550296	40	5,14	166
66IM/90PH3-2P	7314150550319	40	5,14	166
66IM/90PZ2-2P	7314150550333	40	5,14	166
66IM/90PZ3-2P	7314150550357	40	5,14	166
66IM/90T15C-2P	7314150550371	40	5,14	166
66IM/90T20C-2P	7314150550395	40	5,14	166
66IM/90T25C-2P	7314150550418	40	5,14	166
66IM/90T30C-2P	7314150550432	40	5,14	166
66IM/90T40C-2P	7314150550456	40	5,14	166
66IM/K50-1/2-1P	7314150549917	20	9,26	167
66IM/K50-1/4-1P	7314150549931	20	9,26	167
66IM/K50-3/8-1P	7314150549955	20	9,26	167
66IM/KM150-1P	7314150549979	20	13,38	166
66IM/KM300-1P	7314150549993	20	16,47	166
66IM/KM75-1P	7314150550012	20	8,23	166
66IM/KM75QR-1P	7314150550036	20	13,38	166
66IM/M50-10-1P	7314150550050	20	7,20	166
66IM/M50-11-1P	7314150550074	20	7,20	166
66IM/M50-13-1P	7314150550098	20	8,23	166
66IM/M50-6-1P	7314150550111	20	7,20	166
66IM/M50-7-1P	7314150550135	20	7,20	166
66IM/M50-8-1P	7314150550159	20	7,20	166
66IM/PH1-10P	7314150550739	50	9,26	165
66IM/PH1-2P	7314150445929	80	3,14	165
66IM/PH2-10P	7314150550753	50	9,26	165
66IM/PH2-25P	7314150550777	25	16,47	165
66IM/PH2-2P	7314150445936	80	3,14	165
66IM/PH3-10P	7314150550791	50	9,26	165
66IM/PH3-2P	7314150445943	80	3,14	165
66IM/PZ1-10P	7314150550814	50	9,26	165
66IM/PZ1-2P	7314150445950	80	3,14	165
66IM/PZ2-10P	7314150550838	50	9,26	165
66IM/PZ2-25P	7314150550852	25	16,47	165
66IM/PZ2-2P	7314150445967	80	3,14	165
66IM/PZ3-10P	7314150550876	50	9,26	165
66IM/PZ3-2P	7314150445974	80	3,14	165
66IM/T10C-10P	7314150550913	50	9,26	165
66IM/T10C-2P	7314150445981	80	3,23	165
66IM/T15C-10P	7314150550937	50	9,26	165
66IM/T15C-2P	7314150445998	80	3,23	165
66IM/T20C-10P	7314150550951	50	9,26	165
66IM/T20C-25P	7314150550975	25	16,47	165
66IM/T20C-2P	7314150446001	80	3,23	165
66IM/T25C-10P	7314150550999	50	9,26	165
66IM/T25C-25P	7314150551019	25	16,47	165
66IM/T25C-2P	7314150446018	80	3,23	165
66IM/T27C-10P	7314150551033	50	9,26	165
66IM/T27C-2P	7314150446025	80	3,23	165
66IM/T30C-10P	7314150551057	50	9,26	165
66IM/T30C-25P	7314150551071	25	16,47	165
66IM/T30C-2P	7314150446032	80	3,23	165
66IM/T40C-10P	7314150550890	50	9,26	165
66IM/T40C-2P	7314150446049	80	3,23	165
6700SM-10	7314151088026	5	5,28	81
6700SM-11	7314151088033	5	5,28	81
6700SM-12	7314151088040	5	5,28	81



6700SM-13	7314151088057	5	5,28	81
6700SM-14	7314151088064	5	5,28	81
6700SM-4	7314151087944	5	5,28	81
6700SM-4.5	7314151087951	5	5,28	81
6700SM-5	7314151087968	5	5,28	81
6700SM-5.5	7314151087975	5	5,28	81
6700SM-6	7314151087982	5	5,28	81
6700SM-7	7314151087999	5	5,28	81
6700SM-8	7314151088002	5	5,28	81
6700SM-9	7314151088019	5	5,28	81
6700SZ-1/2	7314151088194	5	5,37	81
6700SZ-1/4	7314151088132	5	5,37	81
6700SZ-1/8	7314150346349	5	5,37	81
6700SZ-11/32	7314151088163	5	5,37	81
6700SZ-3/16	7314151088118	5	5,37	81
6700SZ-3/8	7314151088170	5	5,37	81
6700SZ-5/16	7314151088156	5	5,37	81
6700SZ-5/32	7314151808556	5	5,37	81
6700SZ-7/16	7314151088187	5	5,37	81
6700SZ-7/32	7314151088125	5	5,37	81
6700SZ-9/16	7314151088200	5	5,37	81
6700SZ-9/32	7314151088149	5	5,37	81
6700TORX-E10	7314153011725	5	7,08	81
6700TORX-E4	7314153011671	5	7,08	81
6700TORX-E5	7314153011688	5	7,08	81
6700TORX-E6	7314153011695	5	7,08	81
6700TORX-E7	7314153011701	5	7,08	81
6700TORX-E8	7314153011718	5	7,08	81
6706TE	7314150220199	1	48,41	71
6708DMB	7314150220205	1	97,43	71
6709-IP10	7314150354498	1	9,03	86
6709-IP15	7314150354504	1	9,03	86
6709-IP20	7314150354511	1	9,03	86
6709-IP25	7314150354528	1	9,37	86
6709-IP27	7314150354535	1	9,03	86
6709-IP30	7314150354542	1	8,64	86
6709-IP40	7314150354559	1	10,77	86
6709-IP45	7314150354566	1	10,77	86
6709-IP6	7314150460373	1	8,64	86
6709-IP7	7314150460366	1	8,64	86
6709-IP8	7314150460359	1	8,97	86
6709-IP9	7314150460342	1	8,97	86
6709F-4.5	7314151830762	5	7,01	85
6709F-5.5	7314151830779	5	7,01	85
6709F-6.5	7314150220397	5	7,01	85
6709F-8	7314151830786	5	7,01	85
6709HL	7314150128457	100	9,99	84
6709M-10	7314150430833	5	6,93	86
6709M-3	7314151830656	5	6,94	86
6709M-4	7314151830663	5	6,94	86
6709M-5	7314151830670	5	6,94	86
6709M-6	7314151830687	5	6,94	86
6709M-8	7314151830694	5	6,94	86
6709PH-1	7314151830700	5	7,67	85
6709PH-2	7314151830717	5	7,67	85
6709PH-3	7314151830724	5	7,67	85
6709PH-4	7314150489725	5	7,67	85
6709PZ-1	7314151830731	5	8,15	85
6709PZ-2	7314151830748	5	8,15	85
6709PZ-3	7314151830755	5	8,15	85
6709TORX-R-T10	7314153002471	1	9,05	86
6709TORX-R-T15	7314153002488	1	9,05	86
6709TORX-R-T20	7314153002495	1	9,05	86
6709TORX-R-T25	7314153002501	1	9,38	86
6709TORX-R-T8	7314153002464	1	9,05	86
6709TORX-T10	7314151811679	5	8,64	86
6709TORX-T15	7314151811686	5	8,64	86
6709TORX-T20	7314151811693	5	8,64	86
6709TORX-T25	7314151811709	5	8,93	86
6709TORX-T27	7314151811716	5	8,93	86
6709TORX-T30	7314151811723	5	8,93	86
6709TORX-T40	7314153002457	5	8,93	86
6709TORX-T6	7314150460540	5	8,33	86
6709TORX-T7	7314150460557	5	8,33	86
6709TORX-T8	7314153002440	5	8,64	86
6709TORX-T9	7314151811662	5	8,64	86
671002600*	8413345128971	50	153,13	541
671002850*	8413345128988	1	116,98	541
6711MB	7314150220298	1	61,54	71
6712RN	7314151838232	1	123,98	67
6713MH	7314150220212	1	70,70	71
6715GE	7314151831370	1	230,19	69
6715GJ	7314151831363	1	263,84	69
6715MG	7314151831349	1	211,65	69
6715MGS	7314151831332	1	171,89	67
6715MZ	7314153003218	1	213,07	70
6715PZ	7314151837525	1	262,88	69
6717MBP	7314150218806	1	179,21	68
6719MHR	7314150218783	1	185,03	68
6719SM	7314151820817	1	175,31	68
6720NM	7314151088262	1	320,71	70
6721NM	7314151088309	1	286,40	69
6722M	7314151594411	1	233,63	69
6729MHP	7314150218752	1	198,88	68
6729MHR	7314150218769	1	195,45	68
6729SM	7314153003225	1	82,06	70



€		€		
6729SZ	7314153003232	1	54,86	70
6730MBP	7314150218776	1	203,52	68
677-10	7314150362486	1	33,61	53
677-13	7314150362493	1	33,61	53
677-3/8	7314150362509	1	33,25	53
677-7	7314150362455	1	33,61	53
677-8	7314150362462	1	33,61	53
677-9	7314150362479	1	33,61	53
679-1/2	7314150363384	1	44,15	56
679-10	7314150357345	1	51,56	56
679-11	7314150357352	1	46,37	56
679-12	7314150357369	1	51,98	56
679-13	7314150357376	1	52,23	56
679-14	7314150357383	1	56,24	56
679-3/8	7314150363360	1	44,15	56
679-7	7314150357536	1	46,37	56
679-7/16	7314150363377	1	44,15	56
679-8	7314150357079	1	46,37	56
679-9	7314150357338	1	47,35	56
679-9/16	7314150363391	1	44,15	56
6852-5	7314150125463	1	279,33	117
6852-5/S17	7314150135875	1	306,60	118
6852P-5	7314150416585	1	314,54	118
6876N	7314151845575	1	281,78	118
6878N	7314151845582	1	288,81	118
6880N	7314151845599	1	319,92	118
690000160	8413345008068	1	62,46	596
690000200	8413345008082	1	78,30	596
690000220	8413345008099	1	78,30	596
690000250	8413345008105	1	88,92	596
690000300	8413345008129	1	96,25	596
690000320	8413345087476	1	96,25	596
690000350	8413345008136	1	123,26	596
690000400	8413345008143	1	132,14	596
690000500	8413345008167	1	162,15	596
690000630	8413345111065	1	375,84	596
69079019P	8413345111089	1	1.016,28	596
690900080	8413345016209	4	13,04	596
690900100	8413345016216	4	19,25	596
690900120	8413345016223	2	19,25	596
690900140	8413345016230	2	28,72	596
690900200	8413345016247	1	56,74	596
6950	7314151089641	1	42,04	87
6950-SPARE	7314150187867	1	18,67	88
6950CBR	7314150535781	10	11,72	88
6950MH	7314150535101	10	13,95	87
6950MHS	7314150535118	10	13,95	87
6950QR	7314150540198	10	22,78	87
6950QRS	7314150540211	10	22,81	87
6950RN	7314151831189	1	38,10	87
6950RN-SPARE	7314150209149	1	17,93	88
6950SL	7314150197668	1	42,45	87
6950SL-SPARE	7314150210251	1	18,16	88
6951	7314151089764	1	82,84	88
6954-5	7314150489183	10	11,98	83
6956	7314151089825	10	12,38	83
6956MH	7314150537365	10	12,57	83
6957-6	7314150537341	10	8,55	83
6958-6	7314150476329	1	22,23	83
6960-14	7314150489343	1	16,97	84
6960-3	7314150489381	10	9,55	84
6960-6	7314150489428	10	2,71	84
6960F-6	7314150489206	20	10,16	84
6960W-2	7314150470860	10	11,35	84
6960W-4	7314150470877	1	13,25	84
6960W-6	7314150470884	10	15,14	84
6966	7314151089986	10	24,34	84
6968	7314150128426	100	30,99	84
6969	7314150489268	1	1,38	85
696EX-01	7314150386192	1	7,94	84
696EX-06*	7314150386239	1	9,58	84
696EX-11	7314150386208	1	14,56	84
6972H	7314151215934	1	23,27	84
6973A	7314150339495	10	7,51	84
6973M	7314150339501	1	6,89	84
6973N	7314151845605	1	305,91	117
6976N	7314151845612	1	313,02	117
6978N	7314151845629	1	319,93	117
6M-10-11	7314151832094	10	6,14	50
6M-10-13	7314151832117	10	7,54	50
6M-12-13	7314151832131	10	7,47	50
6M-12-14	7314151832148	10	7,99	50
6M-13-14	7314151832155	10	7,92	50
6M-13-15	7314151832162	10	8,79	50
6M-13-16	7314151832179	10	9,52	50
6M-13-17	7314151832186	10	9,34	50
6M-14-15	7314151832193	10	7,92	50
6M-14-17	7314151832209	10	9,19	50
6M-16-17	7314151832216	10	9,19	50
6M-16-18	7314151832223	10	10,05	50
6M-17-19	7314151832230	10	10,35	50
6M-18-19	7314151832247	10	10,35	50
6M-19-22	7314151832261	10	12,52	50
6M-19-24	7314151832278	10	13,29	50
6M-20-22	7314151832285	10	12,27	50
6M-21-23	7314151832292	10	13,37	50

\* Hasta agotar existencias

€		€		
6M-21-24	7314151838072	10	14,76	50
6M-22-24	7314151832308	10	13,35	50
6M-24-26	7314151832315	10	15,53	50
6M-24-27	7314151832322	10	15,83	50
6M-24-30	7314151832339	5	18,32	50
6M-25-28	7314151832353	5	18,05	50
6M-27-29	7314150189861	5	21,49	50
6M-27-30	7314151832360	5	22,42	50
6M-27-32	7314151832377	5	24,53	50
6M-30-32	7314151832384	5	24,23	50
6M-30-36	7314151832407	5	40,33	50
6M-32-36	7314151832414	5	42,41	50
6M-34-36	7314151832421	1	44,52	50
6M-36-41	7314151832438	1	48,34	50
6M-38-42	7314151832445	1	57,47	50
6M-4-5	7314151832018	10	5,60	50
6M-4-5-5-5	7314151832025	10	7,18	50
6M-41-46	7314151832452	1	68,03	50
6M-46-50	7314151832469	1	88,69	50
6M-5-5-5	7314151832032	10	7,25	50
6M-5-5-7	7314151832049	10	5,61	50
6M-6-7	7314151832056	10	5,61	50
6M-7-8	7314151832063	10	5,95	50
6M-8-10	7314151832087	10	6,07	50
6M-8-9	7314151832070	10	5,64	50
6M/10C	7314150212934	1	95,86	52
6M/12C	7314150212941	1	139,44	52
6M/6C	7314150212910	1	43,06	52
6M/8C	7314150212927	1	66,23	52
6M/S8	7314151832483	1	64,97	51
6M/SH12	7314153013439	1	149,30	51
6M/SH8	7314150201365	1	80,80	51
6MV-10	7314150120871	5	24,18	489
6MV-11	7314150120888	5	24,34	489
6MV-12	7314150120895	5	25,55	489
6MV-13	7314150120901	5	26,85	489
6MV-14	7314150120918	5	26,85	489
6MV-15	7314150120925	5	26,74	489
6MV-16	7314150120932	5	28,17	489
6MV-17	7314150120949	3	28,70	489
6MV-18	7314150120956	3	29,36	489
6MV-19	7314150120963	3	30,46	489
6MV-20	7314150120970	3	31,94	489
6MV-21	7314150120987	3	34,43	489
6MV-22	7314150120994	3	35,93	489
6MV-23	7314150121007	3	40,04	489
6MV-24	7314150121014	3	41,56	489
6MV-27	7314150121021	2	47,92	489
6MV-30	7314150121038	2	53,43	489
6MV-32	7314150121052	2	54,73	489
6MV-6	7314150120833	5	24,81	489
6MV-7	7314150120840	5	25,14	489
6MV-8	7314150120857	5	22,85	489
6MV-9	7314150120864	5	23,91	489
6MV/10T	7314150213023	1	291,12	492
6MV/8T	7314150122141	1	217,17	492
6Z-1-1-1/8	7314151832674	1	18,53	51
6Z-1-1/16-1-1/4	7314151832681	1	24,54	51
6Z-1-1/4-1-3/8	7314151832698	1	42,60	51
6Z-1/2-9/16	7314151832568	5	8,15	51
6Z-1/4-5/16	7314151832520	5	5,76	51
6Z-11/16-3/4	7314151832612	5	10,61	51
6Z-13/16-7/8	7314151832643	5	12,65	51
6Z-15/16-1	7314151832667	5	16,00	51
6Z-19/32-11/16	7314151832582	5	10,22	51
6Z-25/32-13/16	7314151832636	5	14,61	51
6Z-3/4-7/8	7314151832629	5	12,65	51
6Z-3/8-7/16	7314151832544	5	6,44	51
6Z-5/16-11/32	7314151832537	5	5,76	51
6Z-5/8-3/4	7314151832605	5	10,61	51
6Z-7/16-1/2	7314151832551	5	7,69	51
6Z-7/8-15/16	7314151832650	5	16,36	51
6Z-9/16-5/8	7314151832575	5	8,15	51
6Z/8C	7314150212958	1	77,07	52
700-1-50	7314153017673	5	7,90	220
700-1-2-50	7314153017680	5	7,90	220
700-1-5-50	7314153017697	5	7,90	220
700-1-8-50	7314153017703	5	7,90	220
700-2-50	7314153017710	5	6,91	220
700-2-5-50	7314153017741	5	6,91	220
700-3-100	7314153017772	5	6,61	220
700-3-200	7314153017789	5	7,60	220
700-3-50	7314153017765	5	6,61	220
700-3-5-75	7314153017796	5	6,91	220
700-4-250	7314153017819	5	8,92	220
700-4-75	7314153017802	5	7,16	220
701-0-200	7314153017857	5	8,69	220
701-0-50	7314153017840	5	6,91	220
701-00-50	7314153017833	5	8,20	220
701-1-250	7314153017871	5	8,21	220
701-1-75	7314153017864	5	7,74	220
702-0-50	7314153017888	5	7,79	220
702-1-75	7314153017895	5	8,28	220
703-10-50	7314153017963	5	7,57	220
703-15-75	7314153017970	5	7,57	220
703-20-75	7314153017987	5	7,57	220





703-4-50	7314153017901	5	9,46	220
703-5-50	7314153017918	5	9,46	220
703-6-50	7314153017925	5	7,57	220
703-7-50	7314153017932	5	7,57	220
703-8-50	7314153017949	5	7,57	220
703-9-50	7314153017956	5	7,57	220
704-1.5-50	7314153017994	5	8,69	221
704-2-50	7314153018007	5	8,69	221
704-2.5-50	7314153018014	5	8,69	221
704-3-75	7314153018021	5	8,69	221
704Z-3/32	7314150137428	5	8,68	221
706-1	7314153018045	1	47,03	219
706-2	7314153018052	1	49,03	219
706-3	7314153018069	1	49,03	219
706-4	7314153018076	1	55,24	219
706-5	7314153018083	1	187,04	220
70S/1.2-8.0-2P	7314150262823	25	8,63	175
70S/1.6-10.0-2P	7314150261017	25	12,26	175
70S/1.6-9.0	7314150218400	1	21,58	175
70S/1.6-9.0-2P	7314150261024	25	8,63	175
70S/2.0-12.0	7314150218417	1	33,49	175
70S/2.0-12.0-2P	7314150261086	25	13,39	175
70S/2.5-14.0	7314150218424	1	37,78	175
70S/2.5-14.0-2P	7314150261147	25	15,12	175
70S/H10*	7314150218486	1	22,93	176
70S/H10-2P	7314150261451	25	9,17	176
70S/H12	7314150218493	1	24,42	176
70S/H12-2P	7314150261468	25	9,75	176
70S/H14	7314150218509	1	24,42	176
70S/H14-2P	7314150261475	25	9,75	176
70S/H4	7314150218431	1	18,96	176
70S/H4-2P	7314150261352	25	7,59	176
70S/H5-2P	7314150261406	25	7,59	176
70S/H6-2P	7314150261437	25	7,59	176
70S/H7	7314150218462	1	18,96	176
70S/H7-2P	7314150261444	25	7,59	176
70S/H8-2P	7314150262847	25	7,59	176
70S/PH1	7314150217557	1	18,96	176
70S/PH1-2P	7314150260621	25	7,59	176
70S/PH2	7314150217564	1	18,96	176
70S/PH2-2P	7314150260638	25	7,59	176
70S/PH3	7314150217571	1	18,96	176
70S/PH3-2P	7314150260645	25	7,59	176
70S/PH4	7314150217588	1	18,96	176
70S/PH4-2P	7314150260652	25	7,59	176
70S/PZ1	7314150217595	1	18,96	176
70S/PZ1-2P	7314150260683	25	7,59	176
70S/PZ2	7314150217601	1	18,96	176
70S/PZ2-2P	7314150260706	25	7,59	176
70S/PZ3	7314150217724	1	18,96	176
70S/PZ3-2P	7314150260720	25	7,59	176
70S/PZ4	7314150217731	1	18,96	176
70S/PZ4-2P	7314150260737	25	7,59	176
70S/T20	7314150217748	1	23,77	176
70S/T20-2P	7314150260744	25	9,51	176
70S/T25-2P	7314150260812	25	9,51	176
70S/T25-5P	7314150538508	50	23,77	176
70S/T27-2P	7314150260867	1	9,51	176
70S/T30-2P	7314150260881	25	9,51	176
70S/T40-5P	7314150538560	50	23,77	176
70S/T45	7314150217793	1	23,77	176
70S/T45-2P	7314150260904	25	9,51	176
70S/T50	7314150217809	1	23,77	176
70S/T50-2P*	7314150260911	25	9,51	176
70S/T55	7314150217816	1	32,90	176
70S/T55-2P	7314150260928	25	13,14	176
70S/TS1/4	7314150218349	1	39,61	176
70S/TS1/4-2P	7314150260935	25	15,84	176
70S/TS10	7314150218356	1	44,42	176
70S/TS10-2P	7314150260942	25	17,77	176
70S/TS5/16	7314150218363	1	44,42	176
70S/TS5/16-2P	7314150260959	25	17,77	176
70S/TS8	7314150218370	1	44,42	176
70S/TS8-2P	7314150260966	25	17,77	176
7106J*	7314150339518	1	8,79	92
7154TC	7314150475148	10	200,85	634
7190	7314150052479	10	54,08	630
7190 CO	7314150052790	10	54,08	630
7191	7314150052509	10	56,65	630
7191 CO	7314150052806	10	56,65	630
7223	7314150237722	4	34,32	251
7223D*	7314150421527	8	33,16	251
7223D IP*	7314150440306	8	31,93	251
7223IP	7314150421855	8	32,54	251
7224	7311518274733	4	35,46	251
7224-622XD-3P	7314150426973	1	90,67	252
7224IP	7314150421831	4	33,77	251
7224S	7314150421657	4	40,52	489
7225	7314150237739	8	44,65	251
7225D*	7314150421541	4	43,60	251
7225D IP*	7314150440320	4	42,61	251
7225IP	7314150421848	4	42,97	251
7280	7314150052523	10	56,65	632
7285	7314150052530	10	56,65	632
7290	7314150052547	10	56,65	631
7291	7314150052554	10	59,23	631



7292	7314150052578	10	51,50	631
7292G	7314150434701	10	66,95	633
7293	7314150052592	10	61,80	631
7372I-2-63	7314151398668	10	13,57	225
7372I-2.5-75	7314151399047	10	13,57	225
7372I-3-80	7314151341602	10	13,57	225
7400SM-10	7314151092955	5	6,30	88
7400SM-11	7314151092962	5	6,39	88
7400SM-12	7314151092979	5	6,48	88
7400SM-13	7314151092986	5	6,64	88
7400SM-14	7314151092993	5	7,10	88
7400SM-15	7314151093006	5	7,37	88
7400SM-16	7314151831127	5	7,79	88
7400SM-17	7314151093020	5	7,97	88
7400SM-18	7314151831134	5	8,16	88
7400SM-19	7314151093044	5	8,49	88
7400SM-20	7314153002570	5	8,71	88
7400SM-21	7314153002587	5	8,97	88
7400SM-22	7314153002594	5	9,12	88
7400SM-6	7314151092917	5	5,75	88
7400SM-7	7314151092924	5	5,75	88
7400SM-8	7314151092931	5	5,85	88
7400SM-9	7314151092948	5	6,08	88
7400SR/S12	7314153003294	1	84,69	73
7400SZ-1/2	7314150385942	1	7,56	89
7400SZ-1/4	7314150385959	1	7,44	89
7400SZ-11/16	7314150385966	1	7,67	89
7400SZ-11/32	7314150385973	1	7,67	89
7400SZ-13/16	7314150385980	1	7,67	89
7400SZ-3/4	7314150385997	1	7,67	89
7400SZ-3/8	7314150386000	1	7,44	89
7400SZ-5/16	7314150386017	1	7,44	89
7400SZ-5/8	7314150386024	1	7,67	89
7400SZ-7/16	7314150386031	1	7,56	89
7400SZ-7/8	7314150386048	1	7,67	89
7400SZ-9/16	7314150386055	1	7,56	89
7400TORX-E10	7314153003058	5	11,21	90
7400TORX-E11	7314153003065	5	11,21	90
7400TORX-E12	7314153003072	5	11,21	90
7400TORX-E14	7314153003089	5	12,25	90
7400TORX-E16	7314153003096	5	12,25	90
7400TORX-E18	7314153003102	5	12,85	90
7400TORX-E8	7314150118243	5	11,21	90
7400TORX-ER/S7	7314153003300	1	82,62	73
7402GPR-16	7314150503087	120	3,03	303
7402GPR-18	7314150503094	120	5,20	303
7402GPR-21	7314150503100	100	3,56	303
7406ZZ-16	7314153011992	1	32,93	303
7406ZZ-21	7314153012005	1	32,93	303
7407H	7314151218249	1	25,99	180
7408H	7314151218300	1	25,99	180
7408MD	7314150220328	1	121,67	73
7409BH-10	7314153002112	5	14,43	94
7409BH-4	7314153002075	5	11,74	94
7409BH-5	7314153002082	1	11,74	94
7409BH-6	7314153002099	5	11,74	94
7409BH-8	7314153002105	5	12,73	94
7409F-10	7314153002143	5	6,74	93
7409F-6.5	7314153002129	5	6,74	93
7409F-8	7314153002136	5	6,74	93
7409H	7314151218355	1	30,12	180
7409M-10	7314153001962	5	11,98	94
7409M-3	7314153002235	5	10,94	94
7409M-4	7314153001900	5	10,94	94
7409M-5	7314153001917	5	10,94	94
7409M-6	7314153001924	5	10,94	94
7409M-7	7314153001931	5	10,94	94
7409M-8	7314153001948	5	11,98	94
7409MB	7314150220236	1	71,57	73
7409MR/S7	7314153003256	1	79,49	94
7409PH-1	7314153002150	5	7,10	93
7409PH-2	7314153002167	5	7,10	93
7409PH-3	7314153002174	5	7,10	93
7409TORX-R-T27	7314153001856	5	13,39	93
7409TORX-R-T30	7314153001863	5	13,39	93
7409TORX-R-T40	7314153001870	5	15,75	93
7409TORX-R-T45	7314153001887	5	16,07	93
7409TORX-R-T50	7314153001894	5	16,72	93
7409TORX-T20	7314150220403	5	12,07	93
7409TORX-T25	7314153001771	5	12,07	93
7409TORX-T25-L	7314153011237	5	19,62	94
7409TORX-T27	7314153001788	5	12,07	93
7409TORX-T30	7314153001795	5	12,07	93
7409TORX-T30-L	7314153011244	5	19,62	94
7409TORX-T40	7314153001801	5	14,64	93
7409TORX-T40-L	7314153011251	5	22,95	94
7409TORX-T45	7314153001818	5	14,64	93
7409TORX-T45-L	7314153011268	5	22,95	94
7409TORX-T50	7314153001825	5	14,64	93
7409TORX-T50-L	7314153011275	5	22,95	94
7409TORX-TRR/S5	7314153003263	1	72,36	93
7409Z-1/4	7314150386062	1	9,86	94
7409Z-1/8	7314150386079	1	9,86	94
7409Z-3/16	7314150386086	1	9,86	94
7409Z-3/8	7314150386093	1	10,79	94
7409Z-5/32	7314150386109	1	9,86	94

			€	
7409Z-7/32	7314150386116	1	9,86	94
7422MBR	7314150218844	1	256,19	73
7422MHR	7314150218868	1	249,11	73
7444SG-M-100	7314151830014	1	489,12	57
7444SG-M-105	7314151830021	1	551,78	57
7444SG-M-110	7314151830038	1	608,39	57
7444SG-M-115	7314151830045	1	700,24	57
7444SG-M-120	7314151830052	1	1.019,38	57
7444SG-M-125	7314151830069	1	1.318,72	57
7444SG-M-130	7314151830076	1	1.434,20	57
7444SG-M-135	7314151830083	1	1.479,39	57
7444SG-M-140	7314151830090	1	1.677,78	57
7444SG-M-145	7314151830106	1	2.329,45	57
7444SG-M-150	7314151830113	1	2.452,30	57
7444SG-M-155	7314151830120	1	2.662,55	57
7444SG-M-160	7314150132508	1	2.821,47	57
7444SG-M-165	7314150132515	1	2.997,25	57
7444SG-M-170	7314150132522	1	3.294,40	57
7444SG-M-175	7314150132539	1	3.534,01	57
7444SG-M-24	7314150205400	1	37,37	57
7444SG-M-27	7314151829834	1	40,64	57
7444SG-M-30	7314151829841	1	41,88	57
7444SG-M-32	7314151829858	1	41,88	57
7444SG-M-34	7314151838560	1	61,35	57
7444SG-M-36	7314151829865	1	53,47	57
7444SG-M-38	7314150180936	1	62,92	57
7444SG-M-41	7314151829872	1	68,27	57
7444SG-M-42	7314151829889	1	68,27	57
7444SG-M-46	7314151829896	1	74,82	57
7444SG-M-50	7314151829919	1	84,12	57
7444SG-M-55	7314151829926	1	96,20	57
7444SG-M-60	7314151829933	1	101,40	57
7444SG-M-65	7314151829940	1	135,90	57
7444SG-M-70	7314151829957	1	157,16	57
7444SG-M-75	7314151829964	1	168,76	57
7444SG-M-80	7314151829971	1	224,52	57
7444SG-M-85	7314151829988	1	300,67	57
7444SG-M-90	7314151829995	1	393,10	57
7444SG-M-95	7314151830007	1	434,33	57
7444SG-Z-1.1/16	7314150132546	1	44,71	57
7444SG-Z-1.1/4	7314150132577	1	46,07	57
7444SG-Z-1.1/8	7314150132553	1	46,07	57
7444SG-Z-1.11/16	7314150132638	1	75,09	57
7444SG-Z-1.13/16*	7314150132652	1	82,31	57
7444SG-Z-1.3/16	7314150132560	1	46,07	57
7444SG-Z-1.3/4	7314150132645	1	82,31	57
7444SG-Z-1.3/8	7314150132591	1	67,51	57
7444SG-Z-1.5/16	7314150132584	1	67,51	57
7444SG-Z-1.5/8	7314150132621	1	75,09	57
7444SG-Z-1.7/16	7314150132607	1	67,51	57
7444SG-Z-1.7/8	7314150132669	1	92,52	57
7444SG-Z-2	7314150132676	1	92,52	57
7444SG-Z-2.1/16	7314150132683	1	105,83	57
7444SG-Z-2.1/4	7314150132713	1	111,57	57
7444SG-Z-2.1/8	7314150132690	1	111,57	57
7444SG-Z-2.3/16	7314150132706	1	111,57	57
7444SG-Z-2.3/4	7314150132768	1	172,89	57
7444SG-Z-2.3/8	7314150132720	1	137,80	57
7444SG-Z-2.5/8	7314150132751	1	172,89	57
7444SG-Z-2.9/16	7314150132744	1	172,89	57
7444SG-Z-3	7314150132775	1	185,64	57
7444SG-Z-3.1/2	7314150132805	1	432,41	57
7444SG-Z-3.1/8	7314150132782	1	293,92	57
7444SG-Z-3.3/4	7314150132812	1	477,78	57
7444SG-Z-3.3/8	7314150132799	1	330,73	57
7444SG-Z-3.7/8	7314150132829	1	538,05	57
7444SG-Z-4	7314150132836	1	606,95	57
7444SG-Z-4.1/2	7314150132850	1	770,26	57
7444SG-Z-4.1/8	7314150132843	1	606,95	57
7454-1400*	7314150119592	1	2.411,07	115
7454-1400E*	7314150119615	1	3.929,34	115
7454-140A*	7314150509515	1	479,53	114
7454-17*	7314150509492	1	336,31	114
7454-230*	7314150509522	1	488,01	114
7454-3.5*	7314150509478	1	336,31	114
7454-32*	7314150509508	1	251,63	114
7454-480*	7314150119578	1	1.058,50	115
7454-70A*	7314150509577	1	357,52	114
7454-8.4*	7314150509485	1	336,31	114
7454-800A*	7314150509584	1	859,33	114
7454-800E*	7314150119608	1	1.764,18	115
7455-100	7314150125111	1	259,45	113
7455-1000	7314150368303	1	1.122,77	113
7455-100A	7314150340156	1	245,19	113
7455-15	7314150119646	1	259,44	112
7455-1500	7314150125166	1	2.049,57	113
7455-20	7314150125074	1	259,44	112
7455-200	7314150125128	1	285,38	113
7455-25	7314150125081	1	259,44	112
7455-2500	7314150125173	1	5.811,44	113
7455-300	7314150125104	1	320,33	113
7455-340	7314150125135	1	320,33	113
7455-5	7314150119639	1	259,44	112
7455-500	7314150125142	1	648,60	113
7455-60	7314150125098	1	259,45	112
7455-800	7314150125159	1	843,20	113

\* Hasta agotar existencias

			€	
7456-80LB	7314150119783	1	324,32	113
7465-100	7314150340200	1	245,19	113
7465-15	7314150340170	1	232,30	113
7465-1500	7314150340248	1	1.793,83	113
7465-200	7314150340217	1	277,46	113
7465-30	7314150340187	1	238,75	113
7465-340	7314150340224	1	303,27	113
7465-5	7314150340163	1	227,13	113
7465-60	7314150340194	1	245,19	113
7465-800	7314150340231	1	774,31	113
747-1	7314150362899	1	50,16	53
747-1.1/16	7314150362905	1	50,16	53
747-1.1/2	7314150362974	1	61,94	53
747-1.1/4	7314150362936	1	50,16	53
747-1.1/8	7314150362912	1	48,33	53
747-1.11/16	7314150363001	1	87,70	53
747-1.13/16	7314150363025	1	100,57	53
747-1.15/16	7314150363049	1	100,66	53
747-1.3/16	7314150362929	1	50,16	53
747-1.3/4	7314150363018	1	92,61	53
747-1.3/8	7314150362950	1	50,16	53
747-1.5/16	7314150362943	1	51,40	53
747-1.5/8	7314150362998	1	83,40	53
747-1.7/16	7314150362967	1	61,94	53
747-1.7/8	7314150363032	1	100,57	53
747-1.9/16	7314150362981	1	63,80	53
747-1/2	7314150362813	1	33,25	53
747-10	7314150362516	1	33,79	53
747-11	7314150362523	1	35,33	53
747-11/16	7314150362844	1	39,62	53
747-12	7314150362530	1	32,74	53
747-13	7314150362547	1	32,74	53
747-13/16	7314150362868	1	43,17	53
747-14	7314150362554	1	30,42	53
747-15	7314150362561	1	39,01	53
747-15/16	7314150362882	1	50,16	53
747-16	7314150362578	1	39,73	53
747-17	7314150362585	1	36,68	53
747-18	7314150362592	1	43,17	53
747-19	7314150362608	1	36,68	53
747-2	7314150363056	1	103,64	53
747-2.1/16	7314150363063	1	105,25	53
747-2.1/2	7314150363131	1	154,30	53
747-2.1/4	7314150363094	1	137,36	53
747-2.1/8	7314150363070	1	133,68	53
747-2.3/16	7314150364893	1	137,36	53
747-2.3/4	7314150363162	1	160,79	53
747-2.3/8	7314150363117	1	144,38	53
747-2.5/16	7314150363100	1	137,36	53
747-2.5/8	7314150363155	1	160,79	53
747-2.7/16	7314150363124	1	154,30	53
747-2.7/8	7314150363179	1	201,64	53
747-2.9/16	7314150363148	1	154,30	53
747-20	7314150362615	1	49,56	53
747-21	7314150362622	1	49,56	53
747-22	7314150362639	1	49,56	53
747-23	7314150362646	1	50,16	53
747-24	7314150362653	1	50,66	53
747-25	7314150362660	1	50,96	53
747-26	7314150362677	1	51,40	53
747-27	7314150362684	1	50,16	53
747-28	7314150362691	1	54,33	53
747-3/4	7314150362851	1	39,62	53
747-3/8	7314150362790	1	32,52	53
747-30	7314150362707	1	50,16	53
747-32	7314150362714	1	50,16	53
747-34	7314150362721	1	54,71	53
747-36	7314150362738	1	61,94	53
747-40	7314150362745	1	76,66	53
747-41	7314150362752	1	89,54	53
747-42	7314150362769	1	89,54	53
747-46	7314150362776	1	106,09	53
747-5/8	7314150362837	1	39,62	53
747-50	7314150362783	1	106,09	53
747-7/16	7314150362806	1	33,96	53
747-7/8	7314150362875	1	50,16	53
747-9/16	7314150362820	1	33,26	53
749-1	7314150363506	1	56,42	56
749-1.1/16	7314150363513	1	56,42	56
749-1.1/2	7314150363582	1	103,52	56
749-1.1/4	7314150363544	1	65,11	56
749-1.1/8	7314150363520	1	56,42	56
749-1.11/16	7314150363612	1	109,91	56
749-1.13/16	7314150363636	1	127,34	56
749-1.15/16	7314150363650	1	136,66	56
749-1.3/16	7314150363537	1	61,67	56
749-1.3/4	7314150363629	1	124,14	56
749-1.3/8	7314150363568	1	87,24	56
749-1.5/16	7314150363551	1	84,32	56
749-1.5/8	7314150363605	1	109,91	56
749-1.7/16	7314150363575	1	88,96	56
749-1.7/8	7314150363643	1	127,34	56
749-1.9/16	7314150363599	1	105,56	56
749-1/2	7314150363421	1	52,44	56
749-10	7314150538386	10	16,13	56
749-11	7314150538362	10	16,13	56







749-11/16	7314150363452	1	55,57	56
749-13	73141503538348	10	4,67	56
749-13/16	7314150363476	1	55,57	56
749-14	73141503538324	10	17,51	56
749-15	7314150357543	1	59,49	56
749-15/16	7314150363490	1	56,42	56
749-16	7314150357550	1	52,74	56
749-17	7314150357567	1	66,38	56
749-18	7314150357574	1	52,74	56
749-19	7314150357581	1	66,38	56
749-2	7314150363667	1	141,32	56
749-2.1/4	7314150363698	1	147,70	56
749-2.1/8	7314150363674	1	147,70	56
749-2.3/16	7314150363681	1	147,70	56
749-2.3/4	7314150363728	1	172,72	56
749-2.3/8	7314150363704	1	154,71	56
749-2.5/8	7314150363711	1	172,72	56
749-20	7314150357598	1	55,19	56
749-21	7314150357604	1	67,75	56
749-22	7314150357611	1	67,75	56
749-23	7314150357628	1	60,72	56
749-24	7314150357635	1	61,51	56
749-25	7314150357642	1	61,94	56
749-26	7314150357659	1	76,75	56
749-27	7314150357666	1	75,72	56
749-3.1/8	7314150363735	1	247,14	56
749-3/4	7314150363469	1	55,57	56
749-3/8	7314150363407	1	51,50	56
749-5/8	7314150363445	1	55,57	56
749-7/16	7314150363414	1	51,50	56
749-7/8	7314150363483	1	55,06	56
749-9/16	7314150363438	1	55,34	56
7490	7314150052646	10	51,50	635
7490 CO	7314150052875	10	51,50	635
74P14-200	7314150416318	1	195,02	116
74P14-300	7314150416325	1	301,97	116
74P14-400	7314150416332	1	314,54	116
74P9-100	7314150416301	1	195,02	116
74P9-20	7314150416288	1	201,31	116
74P9-60	7314150416295	1	201,31	116
74PR-100	7314150416189	1	216,40	115
74PR-100A	7314150416196	1	216,40	115
74PR-20	7314150416158	1	201,31	115
74PR-200	7314150416202	1	220,18	115
74PR-300	7314150416219	1	264,22	115
74PR-400	7314150416226	1	308,25	115
74PR-60	7314150416165	1	211,37	115
74PR-60A	7314150416172	1	211,37	115
74PS-100	7314150416257	1	195,02	116
74PS-20	7314150416233	1	201,31	116
74PS-200	7314150416264	1	195,02	116
74PS-300	7314150416271	1	301,97	116
74PS-60	7314150416240	1	201,31	116
74S/H10	7314150218622	1	43,72	171
74S/H10-2P	7314150261635	25	17,49	171
74S/H12	7314150218639	1	58,26	171
74S/H12-2P	7314150261659	25	23,30	171
74S/H14	7314150218646	1	58,26	171
74S/H14-2P	7314150261666	1	23,30	171
74S/H17	7314150218653	1	58,26	171
74S/H17-2P	7314150261673	25	23,30	171
74S/H4	7314150218578	1	43,72	171
74S/H4-2P	7314150261543	25	17,49	171
74S/H5-2P	7314150261550	25	17,49	171
74S/H6	7314150218592	1	43,72	171
74S/H6-2P	7314150261567	25	17,49	171
74S/H7	7314150218608	1	43,72	171
74S/H7-2P	7314150261574	25	17,49	171
74S/H8	7314150218615	1	43,72	171
74S/H8-2P	7314150261611	25	17,49	171
74W14-200	7314150415700	1	301,97	112
74W14-300	7314150415717	1	339,70	112
74W14-400	7314150415724	1	402,62	112
74W9-100	7314150415687	1	237,80	112
74W9-15	7314150415656	1	251,64	112
74W9-200	7314150415694	1	301,97	112
74W9-25	7314150415663	1	250,38	112
74W9-50	7314150415670	1	237,80	112
74WR-100	7314150415540	1	251,38	112
74WR-100B	7314150469871	1	251,38	112
74WR-15	7314150415519	1	264,22	112
74WR-200	7314150415557	1	251,38	112
74WR-25	7314150415526	1	264,22	112
74WR-300	7314150415564	1	264,22	112
74WR-340	7314150415571	1	289,38	112
74WR-400	7314150415588	1	349,78	112
74WR-50	7314150415533	1	246,60	112
74WS-100	7314150415625	1	237,80	112
74WS-15	7314150415595	1	251,64	112
74WS-200	7314150415632	1	301,97	112
74WS-25	7314150415601	1	250,38	112
74WS-300	7314150415649	1	339,70	112
74WS-50	7314150415618	1	237,80	112
7590	7314150052660	10	51,50	635
7590 CO	7314150052882	10	51,50	635
7591	7314150197491	1	56,65	635



75EXT	7314150415311	1	245,35	117
75P1-1500	7314150415298	1	1.623,05	116
75P3-1000	7314150415281	1	1.497,23	116
75P3-650	7314150415267	1	1.119,79	116
75P3-800	7314150415274	1	1.226,73	116
75PS-650	7314150415328	1	1.094,62	116
75R1-1500	7314150415236	1	1.400,80	113
75R3-1000	7314150415229	1	1.497,23	113
75R3-650	7314150415205	1	1.119,79	113
75R3-800	7314150415212	1	1.251,89	113
75S-650	7314150415243	1	1.107,21	114
76R1-2000	7314150522378	1	2.111,50	114
76R3-1000	7314150422128	1	748,61	114
76R3-1500	7314150422135	1	1.581,38	114
76R3-600	7314150423118	1	692,01	114
76R3-800	7314150422111	1	717,17	114
76S-600	7314150423125	1	704,58	114
7710	7314151551445	1	79,13	93
7710-SO/1*	7314151809744	1	28,12	92
7750	7314151096427	1	57,00	95
7750-SPARE	7314150187874	1	21,04	95
7750MH	7314150537761	5	29,82	92
7750QR	7314150540174	10	31,78	92
7750RN	7314151831240	1	54,02	92
7750RN-SPARE	7314150209361	1	18,15	95
7750SL	7314150197675	1	60,28	92
7750SL-SPARE	7314150210268	1	19,14	95
7751	7314150386949	10	45,29	94
7752	7314151096533	1	48,27	90
7754-8	7314150539871	10	17,40	90
7755-SO/1	7314153010728	1	29,19	94
7756	7314150489152	6	18,91	90
7756MH	7314150537785	10	19,83	91
7758-10	7314150470891	1	29,90	90
7759	7314151096601	1	41,81	91
7760-3	7314150539949	32	7,21	91
7760-5	7314150539963	10	13,79	91
7760W-3	7314150470907	10	11,53	91
7760W-6	7314150470914	10	12,81	91
7766	7314151096694	1	30,22	91
7767	7314153003577	1	24,90	85
7768	7314150128433	50	42,79	91
776EX-01*	7314150386130	1	12,57	91
776EX-03*	7314150386154	1	12,57	91
776EX-04*	7314150386161	1	14,47	91
776EX-08*	7314150386185	1	16,38	91
7771	7314150539895	5	13,05	91
7772	7314150539918	40	12,66	91
7772H	7314150476336	10	3,20	98
7773A	7314150512270	20	3,08	92
7800DM-10	7314151096991	10	6,59	96
7800DM-11	7314151097011	10	6,72	96
7800DM-12	7314151097035	10	7,11	96
7800DM-13	7314151097059	10	7,42	96
7800DM-14	7314151097073	10	7,81	96
7800DM-15	7314151097097	10	8,09	96
7800DM-16	7314151097110	10	8,24	96
7800DM-17	7314151097134	10	8,57	96
7800DM-18	7314151097158	10	8,57	96
7800DM-19	7314151097172	10	8,90	96
7800DM-20	7314151097196	10	9,15	96
7800DM-21	7314151097219	10	9,39	96
7800DM-22	7314151097233	10	9,73	96
7800DM-23	7314151097257	10	10,23	96
7800DM-24	7314151097271	10	10,97	96
7800DM-25	7314151097295	10	11,14	96
7800DM-26	7314151097318	10	11,37	96
7800DM-27	7314151097332	10	11,68	96
7800DM-28	7314151097356	10	12,54	96
7800DM-29	7314151097363	10	12,86	96
7800DM-30	7314151097370	10	13,02	96
7800DM-31	7314150464548	10	13,24	96
7800DM-32	7314151097387	10	13,53	96
7800DM-33	7314150169351	10	11,92	96
7800DM-34	7314150169405	10	16,98	96
7800DM-36	7314151097400	10	25,64	96
7800DM-8	7314151830854	10	6,59	96
7800DM-9	7314151830861	10	6,59	96
7800DMV-10	7314150121656	10	25,42	490
7800DMV-11	7314150121663	10	25,42	490
7800DMV-12	7314150121670	10	25,42	490
7800DMV-13	7314150121687	10	25,42	490
7800DMV-14	7314150121694	10	25,28	490
7800DMV-15	7314150121700	10	25,28	490
7800DMV-16	7314150121717	10	25,99	490
7800DMV-17	7314150121724	10	26,15	490
7800DMV-18	7314150121731	10	25,75	490
7800DMV-19	7314150121748	10	26,49	490
7800DMV-20	7314150121755	10	26,88	490
7800DMV-21	7314150121762	10	26,48	490
7800DMV-22	7314150121779	10	26,65	490
7800DMV-24	7314150121786	5	28,06	490
7800DMV-27	7314150121793	5	28,92	490
7800DMV-30	7314150121809	5	31,50	490
7800DMV-32	7314150121816	5	32,68	490
7800DMV-8	7314150121649	10	24,70	490

			€	
7800DZ-1	7314151097561	10	11,37	96
7800DZ-1.1/16	7314151097578	10	12,03	96
7800DZ-1.1/2	7314150464562	10	11,56	96
7800DZ-1.1/4	7314151097608	10	13,69	96
7800DZ-1.1/8	7314151097585	10	12,79	96
7800DZ-1.3/16	7314151097592	10	13,52	96
7800DZ-1.3/8	7314150464586	10	12,00	96
7800DZ-1.5/16	7314150166077	10	12,00	96
7800DZ-1.7/16	7314150464609	1	12,48	96
7800DZ-1/2	7314151097455	10	7,61	96
7800DZ-11/16	7314151097493	10	8,81	96
7800DZ-11/32	7314150465712	10	8,33	96
7800DZ-13/16	7314151097523	10	9,73	96
7800DZ-13/32	7314150464623	10	8,33	96
7800DZ-15/16	7314151097554	10	11,29	96
7800DZ-19/32	7314151097479	10	8,33	96
7800DZ-25/32	7314151097516	10	9,39	96
7800DZ-3/4	7314151097509	10	9,24	96
7800DZ-3/8	7314151097431	10	6,75	96
7800DZ-5/16	7314150464647	10	8,33	96
7800DZ-5/8	7314151097486	10	8,57	96
7800DZ-7/16	7314151097448	10	6,93	96
7800DZ-7/8	7314151097530	10	10,06	96
7800DZ-9/16	7314151097462	10	8,11	96
7800SM-10	7314151097851	10	6,72	95
7800SM-11	7314151097868	10	6,72	95
7800SM-12	7314151097875	10	7,11	95
7800SM-13	7314151097882	10	7,42	95
7800SM-14	7314151097899	10	7,81	95
7800SM-15	7314151097905	10	8,09	95
7800SM-16	7314151097912	10	8,24	95
7800SM-17	7314151097929	10	8,57	95
7800SM-18	7314151097936	10	8,57	95
7800SM-19	7314151097943	10	8,90	95
7800SM-20	7314150166206	10	9,34	95
7800SM-21	7314151097967	10	9,39	95
7800SM-22	7314151097974	10	9,73	95
7800SM-23	7314151097981	10	10,23	95
7800SM-24	7314151097998	10	10,97	95
7800SM-25	7314151098001	10	11,14	95
7800SM-26	7314151830823	10	11,37	95
7800SM-27	7314151098025	10	11,68	95
7800SM-28	7314151830830	10	12,54	95
7800SM-29	7314150166213	10	13,02	95
7800SM-30	7314151098056	10	13,02	95
7800SM-32	7314151098063	10	13,28	95
7800SM-33	7314150167319	10	11,92	95
7800SM-34	7314153011305	10	17,77	95
7800SM-36	7314151098087	10	25,17	95
7800SM-8	7314151830793	10	6,59	95
7800SM-9	7314151830809	10	6,72	95
7800SPL-10	7314150549023	10	6,72	97
7800SPL-11	7314150549030	10	6,72	97
7800SPL-12	7314150549641	10	7,11	97
7800SPL-13	7314150549665	10	7,42	97
7800SPL-14	7314150549689	10	7,81	97
7800SPL-15	7314150549702	10	8,09	97
7800SPL-16	7314150549726	10	8,24	97
7800SPL-17	7314150549740	10	8,57	97
7800SPL-18	7314150551224	10	8,57	97
7800SPL-19	7314150551231	10	8,90	97
7800SPL-20	7314150551262	10	9,34	97
7800SPL-21	7314150551286	10	9,39	97
7800SPL-22	7314150551309	10	9,73	97
7800SPL-23	7314150551323	10	10,23	97
7800SPL-24	7314150551347	10	10,97	97
7800SPL-27	7314150551361	10	11,68	97
7800SPL-30	7314150551385	10	7,78	97
7800SPL-32	7314150551408	10	13,28	97
7800SZ-1	7314150542659	10	7,21	96
7800SZ-1.1/16	7314150542673	10	7,02	96
7800SZ-1.1/4	7314150542697	10	8,02	96
7800SZ-1.1/8	7314150542710	10	8,19	96
7800SZ-1.3/16	7314150528387	10	8,02	96
7800SZ-1/2	7314150528400	10	7,61	96
7800SZ-11/16	7314150528424	10	5,57	96
7800SZ-13/16	7314150528448	10	5,88	96
7800SZ-15/16	7314150542734	10	6,90	96
7800SZ-3/4	7314150528462	10	5,78	96
7800SZ-3/8	7314150528486	10	4,54	96
7800SZ-5/8	7314150542758	10	8,56	96
7800SZ-7/16	7314150528509	10	4,72	96
7800SZ-7/8	7314150528523	10	6,23	96
7800SZ-9/16	7314150528547	10	4,78	96
7800TORX-E10	7314150166084	1	10,71	97
7800TORX-E11	7314150220359	1	10,71	97
7800TORX-E12	7314153011800	1	10,71	97
7800TORX-E14	7314153011756	1	10,71	97
7800TORX-E16	7314153011763	1	10,88	97
7800TORX-E18	7314153011770	1	10,88	97
7800TORX-E20	7314153011787	1	11,46	97
7800TORX-E24	7314153011794	1	12,60	97
7800TORX-E8	7314150166091	1	9,53	97
7800TORX/9	7314150469741	1	95,80	100
7805DM-10	7314151822101	10	17,65	96
7805DM-12	7314151098452	10	17,65	96

\* Hasta agotar existencias

			€	
7805DM-13	7314151098469	10	17,65	96
7805DM-14	7314151098476	10	18,46	96
7805DM-15	7314151098483	10	19,39	96
7805DM-16	7314151098490	10	19,95	97
7805DM-17	7314151098506	10	19,95	97
7805DM-18	7314151098513	10	19,95	97
7805DM-19	7314151098520	10	19,95	97
7805DM-21	7314151098544	10	22,17	97
7805DM-22	7314151098551	10	22,38	97
7805DM-23	7314150313532	10	22,45	97
7805DM-24	7314151098568	10	23,05	97
7805DM-26	7314151098582	10	23,05	97
7805DM-27	7314151098599	10	25,54	97
7805DM-30	7314151098605	10	27,32	97
7805DM-32	7314150220281	10	28,00	97
7805DM-34	7314150488537	10	28,00	97
7805DZ-1*	7314150357758	10	20,95	97
7805DZ-1.1/16*	7314150357765	10	22,15	97
7805DZ-1.1/2*	7314150357833	10	46,12	97
7805DZ-1.1/4*	7314150357796	10	25,12	97
7805DZ-1.1/8*	7314150357772	10	24,83	97
7805DZ-1.3/16*	7314150357789	10	23,68	97
7805DZ-1.3/8*	7314150357819	10	28,88	97
7805DZ-1.5/16*	7314150357802	10	27,12	97
7805DZ-1.7/16*	7314150357826	10	46,12	97
7805DZ-11/16*	7314150357703	10	17,27	97
7805DZ-13/16*	7314150357727	10	19,21	97
7805DZ-15/16*	7314150357741	10	19,99	97
7805DZ-3/4*	7314150357710	10	17,27	97
7805DZ-5/8*	7314150357697	10	17,27	97
7805DZ-7/8*	7314150357734	10	19,38	97
7805GPR-16	7314150503117	120	5,02	303
7805GPR-21	7314150503124	100	5,46	303
7805SM-10	7314153011312	10	17,99	95
7805SM-11	7314150475926	10	17,99	95
7805SM-12	7314153011329	10	17,99	95
7805SM-13	7314153011336	10	17,99	95
7805SM-14	7314153011343	10	18,75	95
7805SM-15	7314153011350	10	19,73	95
7805SM-16	7314153011367	10	20,25	95
7805SM-17	7314153011374	10	20,25	95
7805SM-18	7314153011381	10	20,25	95
7805SM-19	7314153011398	10	20,25	95
7805SM-20	7314153011404	10	20,71	95
7805SM-21	7314153011411	10	22,57	95
7805SM-22	7314153011428	10	22,74	95
7805SM-23	7314153011435	10	23,46	95
7805SM-24	7314153011442	10	23,46	95
7805SM-25	7314153011459	10	22,66	95
7805SM-26	7314153011466	10	23,46	95
7805SM-27	7314153011473	10	26,00	95
7805SM-28	7314153011480	10	24,25	95
7805SM-29	7314153011497	10	25,87	95
7805SM-30	7314153011503	10	27,80	95
7805SM-32	7314153011527	10	30,08	95
7805SM-34	7314153024251	10	30,08	95
7805SZ-1.1/2	7314150357987	1	46,12	96
7805SZ-1.1/4	7314150357949	1	25,12	96
7805SZ-1.3/16	7314150357932	1	23,68	96
7805SZ-1.3/8	7314150357963	1	28,88	96
7805SZ-1.5/16	7314150357956	1	27,12	96
7805SZ-1.7/16	7314150357970	1	46,12	96
7806MD	7314150220335	1	106,72	79
7807*	7314153012029	1	12,36	302
7807H	7314151232764	1	35,07	184
7807TE	7314150313792	1	75,17	79
7808H	7314151232771	1	35,07	184
7808HM	7314150220434	1	113,67	101
7809F-10	7314151830892	5	15,03	99
7809F-8	7314151830885	5	14,74	99
7809H	7314151232788	1	33,24	184
7809M-10	7314151815608	1	14,50	100
7809M-10-120	7314150509669	1	11,95	101
7809M-12	7314151815615	1	14,82	100
7809M-12-120	7314150509683	1	11,95	101
7809M-14	7314151815622	1	14,85	100
7809M-14-120	7314150509706	10	11,95	101
7809M-17	7314151831028	1	15,58	100
7809M-17-120	7314150509720	10	11,95	101
7809M-19	7314151831035	1	16,02	100
7809M-19-120	7314150516575	8	11,95	101
7809M-4	7314150214600	10	13,37	100
7809M-4-120	7314150509591	1	11,95	100
7809M-5	7314151815561	1	13,37	100
7809M-5-120	7314150509607	1	11,95	100
7809M-5-180	7314151830922	1	22,10	100
7809M-6	7314151815578	1	13,37	100
7809M-6-120	7314150509621	1	11,95	100
7809M-7	7314151815585	1	13,37	100
7809M-7-100	7314151830960	1	17,58	100
7809M-7-120	7314150509645	1	17,58	100
7809M-8	7314151815592	1	14,50	100
7809M-8-120	7314151830984	1	20,23	101
7809M-9	7314151830991	1	14,50	100
7809M/10	7314151831448	1	151,41	75
7809PH-2	7314151830908	1	12,83	99





# 7809PH-3



7809PH-3	7314151830915	1	13,24	99
7809PH-4	7314153003423	1	13,24	99
7809PZ-3*	7314153003447	1	13,30	100
7809TO	7314150220465	1	156,22	100
7809TORX-T20	7314151811730	1	15,17	100
7809TORX-T20-120	7314150509768	1	20,69	100
7809TORX-T25	7314151811747	1	15,17	100
7809TORX-T25-120	7314150509799	1	20,69	100
7809TORX-T27	7314151811754	1	15,17	100
7809TORX-T27-120	7314150509812	1	20,69	100
7809TORX-T30	7314151811761	1	15,17	100
7809TORX-T30-120	7314150509836	1	20,69	100
7809TORX-T40	7314151811778	1	17,71	100
7809TORX-T40-120	7314150220564	1	22,63	100
7809TORX-T45	7314151811785	1	17,71	100
7809TORX-T45-120	7314150220557	1	22,63	100
7809TORX-T50	7314151811792	1	17,71	100
7809TORX-T50-100	7314150220540	1	22,63	100
7809TORX-T50-120	7314150509850	1	21,33	100
7809TORX-T55	7314151811808	1	22,17	100
7809TORX-T55-120	7314150509874	1	26,20	100
7809TORX-T60	7314151811815	1	22,17	100
7809TORX-T60-120	7314150509898	1	26,20	100
7809TORX-T70	7314150509744	10	22,18	100
7809TORX-T70-120	7314150509911	1	25,41	100
7809TORX-T70-140	7314150220526	5	32,01	100
7809TORX/10	7314151831455	1	165,64	75
7809XZN-10	7314151831080	1	19,67	101
7809XZN-10-100	7314151831097	1	24,32	101
7809XZN-12	7314151831103	1	24,32	101
7809XZN-12-100	7314151831110	1	26,56	101
7809XZN-14	7314153004574	1	25,99	101
7809XZN-14-100	7314153004567	1	30,40	101
7809XZN-16	7314150220458	1	28,48	101
7809XZN-18	7314150314058	1	30,34	101
7809XZN-6	7314150214617	1	18,62	101
7809XZN-8	7314151831066	1	18,75	101
7809XZN-8-100	7314151831073	1	20,51	101
7809Z-1/2	7314153003515	1	14,26	101
7809Z-1/4	7314153003478	1	13,13	101
7809Z-17/32	7314150313785	1	14,74	101
7809Z-19/32	7314153003546	1	15,00	101
7809Z-3/16	7314153003461	1	13,13	101
7809Z-3/8	7314153003492	1	13,13	101
7809Z-5/16	7314153003485	1	13,13	101
7809Z-5/8	7314153003553	1	15,00	101
7809Z-7/16	7314153003508	1	13,50	101
7809Z-9/16	7314153003539	1	14,63	101
7809Z/10	7314153003560	1	146,35	75
7810MB	7314150220380	1	78,04	78
7810MH	7314150220373	1	78,04	78
7811DMV	7314150122134	1	550,06	492
7812	7314150502028	100	13,94	314
7814DS	7314150318964	1	231,88	76
7814DST*	7314150319022	1	200,35	78
7817DZS	7314150319008	1	271,93	77
7817DZS1	7314150389902	1	218,94	77
7818DS	7314150318971	1	281,77	76
7818DST	7314150319039	1	251,14	78
7818MHR	7314150218912	1	283,02	76
7818SST*	7314150319046	1	262,59	78
7819DRN	7314151831547	1	370,14	77
782-U	7311518276447	1	6,89	305
7823	7314150218141	16	77,72	177
7823DZS	7314150319015	1	320,26	77
7825DST*	7314150319060	1	316,64	78
7825MBP	7314150218929	1	338,74	76
7825MHP	7314150218943	1	338,66	76
7825SST	7314150319053	1	316,64	78
783	7311518276034	1	13,99	321
7835 G-160	7314150050253	5	45,84	248
7842MH	7314150555352	1	190,55	75
7847SS	7314150318995	1	582,66	77
7851-G	7314150124909	1	178,08	121
7851-M	7314150124893	1	159,12	121
7865	7311518276720	1	45,13	177
787-1.1/16	7314150363186	1	50,16	53
787-1.1/2	7314150363254	1	63,04	53
787-1.1/4	7314150363216	1	56,27	53
787-1.1/8	7314150363193	1	50,16	53
787-1.11/16	7314150363278	1	140,77	53
787-1.13/16	7314150363292	1	140,77	53
787-1.3/16	7314150363209	1	56,27	53
787-1.3/4	7314150363285	1	140,77	53
787-1.3/8	7314150363230	1	61,18	53
787-1.5/16	7314150363223	1	56,27	53
787-1.5/8	7314150363261	1	69,14	53
787-1.7/16	7314150363247	1	62,41	53
787-1.7/8	7314150363308	1	153,00	53
787-2	7314150363315	1	153,00	53
787-2.1/4	7314150363346	1	183,50	53
787-2.1/8	7314150363322	1	171,30	53
787-2.3/16	7314150363339	1	171,30	53
787-2.3/8	7314150363353	1	195,81	53
7888DM	7314151820923	1	379,84	77
789-1.1/2	7314150363896	1	70,52	57



789-1.1/4	7314150363858	1	61,33	57
789-1.1/8	7314150363841	1	56,42	57
789-1.13/16	7314150363933	1	93,81	57
789-1.3/4	7314150363926	1	98,81	57
789-1.3/8	7314150363872	1	65,01	57
789-1.5/16	7314150363865	1	65,01	57
789-1.5/8	7314150363919	1	80,94	57
789-1.7/16	7314150363889	1	70,52	57
789-1.9/16	7314150363902	1	80,94	57
789-2	7314150363940	1	101,79	57
789-2.1/4	7314150363957	1	114,07	57
789-2.3/8	7314150363971	1	142,27	57
789-2.5/16	7314150363964	1	137,36	57
789-28	7314150363742	1	65,01	57
789-30	7314150363759	1	82,53	57
789-32	7314150357673	1	86,66	57
789-34	7314150363766	1	69,91	57
789-36	7314150363773	1	93,57	57
789-38	7314150363780	1	77,27	57
789-40	7314150363797	1	87,09	57
789-41	7314150363803	1	114,35	57
789-42	7314150363810	1	87,09	57
789-46	7314150363827	1	127,29	57
789-50	7314150363834	1	113,45	57
7890	7314150052891	10	56,65	635
7890 CO	7314150052899	10	59,23	635
7891	7314150052714	10	59,23	635
7891 CO	7314150052905	10	56,65	635
7892	7314150052738	10	43,78	636
7892 CO	7314150291687	10	43,78	636
7893	7314150052769	10	43,78	636
7893K	7314150351428	10	46,35	636
7894	7314150197484	10	51,50	636
790450A	7314150214716	1	67,96	267
790455A	7314150214709	1	57,71	268
7993M0170	8413345115353	1	110,12	189
7993M0190	8413345115377	1	110,12	189
7993M0220	8413345115391	1	125,30	189
7993M0270	8413345115414	1	127,11	189
7993S0050	8413345115070	1	45,37	183
7993S0060	8413345115094	1	41,44	183
7993S0080	8413345115117	1	41,44	183
7993S0100	8413345115131	1	43,97	183
7993S0120	8413345115155	1	43,97	183
7993S0140	8413345115179	1	45,37	183
7993S0170	8413345115193	1	45,37	183
7993S0180	7314150476855	1	45,37	183
7993S0190	8413345115216	1	45,37	183
7993T0120	8413345115230	1	55,21	186
7993T0140	8413345115254	1	60,68	186
7993T0170	8413345115278	1	60,68	186
7993T0190	8413345115292	1	60,68	186
7993T0220	8413345115315	1	72,59	186
7993T0240	8413345115339	1	72,59	186
7994S0200	7314150492954	1	21,75	183
7994S0250	7314150492947	1	22,43	183
7994S0270	7314150492930	1	23,12	183
7994S0300	8413345129305	1	23,76	183
7994S0400	8413345129312	1	23,76	183
7994S0450	8413345129329	1	23,76	183
7994S0500	8413345129336	1	23,76	183
7994S0550	8413345129343	1	25,13	183
7994S0600	8413345129350	1	27,80	183
7994S0700	7314150522583	1	27,81	183
800-1.5-50ESD	8412243589327	10	4,01	629
800-2-50ESD	8412243589341	10	6,10	629
800-2.5-50ESD	8412243589365	10	3,48	629
800-3-50ESD	8412243589389	10	3,31	629
801-0-50ESD	8412243589426	10	4,23	629
801-00-50ESD	8412243589402	10	4,93	629
801-1-75ESD	8412243589440	10	4,64	629
801-7ESD	8412243589280	1	41,06	629
8010SL-2P	7314150243853	1	13,43	486
8020-2P	7314150246601	1	9,04	201
803-10-50ESD	8412243589648	10	7,81	629
803-15-75ESD	8412243589549	10	7,90	629
803-20-75ESD	8412243589563	10	7,96	629
803-6-50ESD	8412243589464	10	5,79	629
803-7-50ESD	8412243589488	10	6,04	629
803-7ESD	8412243589303	1	42,33	629
803-8-50ESD	8412243589501	10	6,11	629
803-9-50ESD	8412243589525	10	7,81	629
8030-2P	7314150246618	1	9,04	201
8040-2P	7314150246625	1	9,04	201
8040L-2P	7314150246670	1	12,91	202
8040SL-2P	7314150243877	1	14,11	486
8045LVDE	7314151509163	10	21,59	226
8045VDE	7314151317256	10	17,63	225
805-TS1-50ESD	8412243589587	10	8,60	629
805-TS4-50ESD	8412243589600	10	6,52	629
805-TS5-50ESD	8412243589624	10	9,17	629
8050SL-2P	7314150243884	1	14,11	486
8052	7314151318406	5	29,59	224
806-1-1	7311518003760	6	4,70	225
806-1-2	7314150183258	6	6,14	225
806-1-3	7314150183265	6	6,22	225

			€	
8069	7314150007028	5	23,00	41
8069 C	7314150007035	5	16,89	41
8069 C IP	7314150101634	5	16,38	41
8069 IP	7314150007042	50	22,27	41
8069-1	7314150239511	1	5,03	41
8069-2	7314150239590	1	3,06	41
8070	7314150007110	5	24,15	41
8070 C	7314150007127	5	17,33	41
8070 C IP	7314150101641	5	16,80	41
8070 IP	7314150007134	40	23,49	41
8070-1	7314150239528	1	5,82	41
8070-2	7314150238606	1	3,19	41
8070V	7314150121519	2	40,31	489
8070VL	7314150213511	1	49,22	489
8071	7314150007202	5	26,20	41
8071 C	7314150007219	5	19,70	41
8071 C IP	7314150101658	5	19,21	41
8071 IP	7314150007226	50	25,54	41
8071-1	7314150239535	1	5,40	41
8071-2	7314150238613	1	3,22	41
8071V	7314150121526	2	49,02	489
8071VL	7314150213535	1	57,44	489
8071VLT	7314150121564	1	162,40	489
8072	7314150007288	5	34,15	41
8072 C	7314150007295	5	23,90	41
8072 C IP	7314150101665	5	23,39	41
8072 IP	7314150007301	30	33,49	41
8072-1	7314150239542	1	5,60	41
8072-2	7314150238620	1	3,53	41
8072V	7314150121533	2	54,64	489
8072VL	7314150213542	1	67,72	489
8072VLT	7314150121571	1	181,59	489
8073	7314150007363	5	49,64	41
8073 C	7314150007370	5	31,46	41
8073 C IP	7314150101672	5	30,94	41
8073 IP	7314150007387	20	48,98	41
8073-1	7314150239559	1	6,47	41
8073-2	7314150238637	1	3,88	41
8073V	7314150121540	2	72,49	489
8073VL	7314150213559	1	88,88	489
8073VLT	7314150121588	1	197,84	489
8074	7314150007448	3	81,11	41
8074 C	7314150007455	3	52,85	41
8074 C IP	7314150101689	3	52,32	41
8074 IP	7314150007462	20	80,46	41
8074-1	7314150239566	1	10,51	41
8074-2	7314150238644	1	4,56	41
8074V	7314150121557	2	117,21	489
8075	7314150007523	3	127,45	41
8075 C	7314150007530	3	82,00	41
8075 C IP	7314150101696	3	81,50	41
8075 IP	7314150007547	10	126,77	41
8075-1	7314150239573	1	13,94	41
8075-2	7314150238651	1	5,10	41
808050	7314153017642	25	43,08	217
808050A	7314150127306	25	27,53	223
808050L	7314150128075	25	41,55	217
808050L-SP1	7314150129218	25	10,56	217
808050P	7314150128105	25	41,55	217
808050P-25	7314150165179	10	131,45	218
808050S	7314150128082	25	22,07	218
808050S-18	7314150128921	30	38,91	218
808050S-22	7314150128938	30	38,91	218
808050TORX	7314150127313	25	26,89	223
808050TS	7314150128099	25	22,07	218
808060	7314150243822	1	41,16	486
808061	7314150243839	5	103,92	486
808062	7314150243846	5	103,92	486
8110H-1/2	7314153015860	1	102,97	102
8120-1/2	7314150384884	12	62,09	102
8120-1/4	7314150384921	20	39,49	87
8120-3/8	7314150384914	10	48,09	93
813	7314150055852	1	6,18	633
8130	7314150050918	10	51,50	630
8130-50/SUPR SPRING	7314150111572	1	160,48	633
8131	7314150050925	10	54,08	630
8131 CO	7314150051519	10	54,08	630
8132	7314150050932	10	56,65	630
8133	7314150470945	10	54,08	630
8134	7314150470952	10	56,65	630
8135	7314150470969	10	59,23	630
8136	7314150470976	10	56,65	631
8137	7314150459728	10	59,23	631
8138	7314150361540	10	61,80	631
814	7314150055845	1	4,64	633
8140	7314150050949	10	51,50	630
8140 CO	7314150051533	10	51,50	630
8140M2	7314150470983	10	61,80	634
8140PS	7314150358472	10	77,25	634
8141	7314150050987	10	54,08	630
8141 CO	7314150051557	10	54,08	630
8141PS	7314150349425	10	77,25	634
8142	7314150051007	10	56,65	630
8142 CO	7314150051564	10	56,65	630
8143	7314150051021	10	54,08	630
8144	7314150051045	10	56,65	630

\* Hasta agotar existencias

			€	
8144 CO	7314150051601	10	56,65	630
8145	7314150051052	10	59,23	630
8146	7314150051076	10	56,65	631
8147	7314150051083	10	59,23	631
8148	7314150051090	10	61,80	631
8148 CO	7314150051656	10	61,80	631
8149	7314150051106	10	77,25	632
8150	7314150051113	10	51,50	630
8150 CO	7314150051670	10	51,50	630
8150 J	7314150051137	10	77,25	636
8150 SK	7314150112814	10	77,25	636
8150-1/2	7314151105006	1	66,85	101
8150-1/2-SPARE	7314150187881	1	31,50	103
8150-1/2V	7314150121601	1	201,01	490
8150M2	7314150470990	10	72,10	634
8150MH	7314153024619	5	40,69	102
8150PS	7314150358489	10	82,40	634
8150QR	7314150540150	3	38,51	101
8150RN-1/2	7314151831202	1	64,56	101
8150RN-1/2-SPARE	7314150209378	1	19,51	103
8150SL	7314150197682	1	68,04	101
8150SL-SPARE	7314150210275	1	21,17	103
8151	7314150051199	10	54,08	630
8151 CO	7314150051694	10	54,08	630
8151-1/2	7314151105112	1	87,93	102
8152	7314150052097	10	56,65	630
8152-1/2	7314151105129	1	48,87	97
8153	7314150051205	10	54,08	630
8154	7314150052103	10	56,65	630
8154 CO	7314150052233	10	56,65	630
8154-1/2V	7314150121595	1	64,11	490
8154-11	7314150469161	10	19,59	98
8154PSP	7314150347704	10	87,55	634
8155	7314150052110	10	59,23	630
8155-SO/1	7314153000811	1	50,51	103
8156	7314150051212	10	56,65	631
8157	7314150052127	10	59,23	631
8157-10	7314150467273	1	97,43	97
8157-15	7314150469222	1	56,66	97
8157-24	7314150469246	1	89,10	97
8157-36	7314150469260	10	136,66	97
8158	7314150052134	10	61,80	631
8158-10	7314150471003	1	31,30	97
8158-15	7314150471010	1	33,42	97
816	7314150428182	1	6,18	633
8160	7314150051229	10	54,08	630
8160 CO	7314150051724	10	54,08	630
8160 J	7314150051250	10	87,55	636
8160 M2	7314150381906	10	82,40	634
8160-1/2V	7314150121618	1	48,01	490
8160-10	7314150469185	10	19,13	98
8160-3	7314150469208	10	12,88	98
8160-5	7314150469284	8	15,18	98
8160-B	7314150182565	1	28,51	98
8160/SPRING	7314150229888	1	94,28	633
8160PS	7314150358496	10	82,40	634
8160W-10	7314150471027	10	21,93	98
8160W-3	7314150471041	10	16,64	98
8160W-5	7314150471065	8	17,47	98
8161	7314150051328	10	56,65	630
8161 CO	7314150051748	10	56,65	630
8161PS	7314150361533	10	84,98	634
8162	7314150051335	10	59,23	630
8162-1/2V	7314150121625	1	51,41	490
8163	7314150051342	10	56,65	630
8163 CO	7314150051762	10	56,65	630
8164	7314150052141	10	59,23	630
8165	7314150052158	10	61,80	630
8165 CO	7314150052288	10	61,80	630
8166	7314150459377	10	33,95	98
8166L	7314150476350	10	61,80	631
8167	7314153003584	1	29,20	92
8167L	7314150476367	10	64,38	631
8168	7314150128440	40	39,47	98
8168L	7314150347711	10	66,95	631
8171	7314150469307	20	17,48	98
8172	7314150469321	10	20,79	99
8174A	7314150476374	10	10,03	99
8178	73141500512065	10	16,13	98
8194-1/2*	7314151831226	1	6,42	102
8195-KEY	7314150389810	50	22,03	99
8195-R	7314150389780	1	54,52	102
8195-SET	7314150389797	5	66,40	102
8195-SQ	7314150389803	25	5,85	102
8211	7314150101030	10	77,25	631
8220SL-2P	7314150243860	1	13,43	486
8223	7314150112685	4	48,41	250
8223 IP	7314150113149	4	47,72	250
8224	7314150000012	4	57,00	250
8224 IP	7314150101757	4	56,31	250
8224CIP	7314150103607	4	35,98	250
8225	7314150000029	4	77,92	250
8225 IP	7314150101764	4	77,23	250
8225CIP	7314150103614	4	48,01	250
8226	7314150115853	1	86,80	250
8231	7311518266509	4	51,13	250



# 8231 IP



8231 IP	7311518270285	4	50,44	250
8242-2P	7314150243686	1	9,14	201
8242L-2P	7314150246687	1	12,91	202
8247	7314150051397	10	77,25	632
8247 CO	7314150051809	10	77,25	632
8248	7314150051427	10	82,40	632
8248 CO	7314150051823	10	82,40	632
8248Q	7314150349364	10	87,55	632
8249	7314150349401	10	82,40	632
8252-2P	7314150243693	1	9,14	201
8252L-2P	7314150246694	1	12,91	202
8252XL-1P	7314150265985	1	11,56	203
833AJ-4	7311518286927	1	38,03	576
833AJ-5	7311518286934	1	39,49	576
833AJ-6	7311518286941	1	41,11	576
833FJ-4	7311518286965	1	43,41	576
833FJ-5	7311518286972	1	44,71	576
833FJ-6	7311518286989	1	46,48	576
833PJ-4	7311518286897	1	34,25	575
833PJ-5	7311518286903	1	42,56	575
833PJ-67	7311518286910	1	42,56	575
833SB-4	7311518286859	1	63,65	576
833SB-5	7311518286866	1	97,14	576
833SB-6	7311518286873	1	112,23	576
833SB-7	7311518286880	1	145,70	576
834V-2	7314150124992	1	130,04	575
834V-4	7311518286811	1	300,32	575
834V-5	7311518286828	1	403,55	575
834V-6	7311518286835	1	509,92	575
834V-7	7311518286842	1	663,20	575
84-PODGER	7314150307494	1	38,22	42
850-1	7311518292737	10	18,12	536
8501-10	7311518004828	1	32,95	147
8501-10F	7311518220945	1	35,29	147
8501-12	7311518004842	1	34,48	147
8501-12F	7311518220952	1	40,57	147
8501-13	7311518004859	1	37,58	147
8501-136-10-24C	7314150371471	1	22,85	147
8501-136-20-24C	7314150371488	1	25,39	147
8501-13F	7311518220969	1	39,99	147
8501-15	7311518004873	1	39,62	147
8501-150-10-24C	7314150403004	1	27,92	147
8501-15F	7311518220976	1	43,35	147
8501-16	7311518004880	1	48,34	147
8501-160-20-24C	7314150403011	1	29,20	147
8501-160-20-48XF	7314150402892	1	29,20	147
8501-165-20-24C	7314150403028	1	29,20	147
8501-165-20-48XF	7314150402908	1	30,47	147
8501-16F	7311518220983	1	52,84	147
8501-16SW	7314150258642	1	50,93	147
8501-17	7311518004897	1	48,07	147
8501-17F	7311518220990	1	54,66	147
8501-17S	7311518221027	1	54,53	147
8501-184-16-24	7314150402946	1	32,99	147
8501-184-16-40	7314150402953	1	34,90	147
8501-184-20-24C	7314150403042	1	31,73	147
8501-18S	7311518221034	1	57,90	147
8501-18SW	7311518221058	1	54,30	147
8501-190-30-24C	7314150403059	1	38,08	147
8501-190-30-60XF	7314150402960	1	41,25	147
8501-2	7311518004743	1	26,29	147
8501-210-30-48SW	7314150403066	1	81,23	147
8501-210-30-60XF	7314150402977	1	48,23	147
8501-216-60SW	7314150359448	1	56,34	147
8501-22	7311518178888	1	48,90	147
8501-22F	7311518221003	1	56,34	147
8501-23	7311518004958	1	49,46	147
8501-230-30-60XF	7314150402984	1	53,30	147
8501-235-30-60XF	7314150402991	1	54,57	147
8501-23F	7311518018887	1	57,05	147
8501-260-24SW	7314150359479	1	74,65	147
8501-260-30-80S	7314150403097	1	82,50	147
8501-260-40SW	7314150359462	1	69,81	147
8501-260-60SW	7314150359455	1	73,62	147
8501-28	7311518018894	1	62,80	147
8501-28F	7311518221010	1	65,42	147
8501-28S	7311518221041	1	86,49	147
8501-28SW	7311518221065	1	72,31	147
8501-28XF	7311518281946	1	72,38	147
8501-3	7311518004750	1	25,59	147
8501-30	7311518237479	1	82,65	147
8501-305-30-40SW	7314150403073	1	43,03	147
8501-305-30-60SW	7314150403080	1	46,97	147
8501-305-30-96S	7314150403103	1	55,34	147
8501-30F	7311518237462	1	85,07	147
8501-30S	7311518282240	1	111,36	147
8501-30SW	7311518282196	1	94,16	147
8501-30XF	7311518281984	1	93,88	147
8501-31	7311518237455	1	84,74	147
8501-31F	7311518237448	1	93,51	147
8501-4	7311518008079	1	26,41	147
8501-40	7311518282042	1	111,56	147
8501-4F	7311518220914	1	27,70	147
8501-4XF	7311518281786	1	29,14	147
8501-5	7311518004774	1	30,64	147
8501-5F	7311518220921	1	32,95	147



8501-7	7311518004798	1	30,35	147
8501-7F	7311518220938	1	32,48	147
8510SL-2P	7314150245758	1	20,92	486
8520SL-2P	7314150245765	1	20,92	486
86	7314150005376	1	285,33	41
86-1	7314150254996	1	8,30	41
86-2	7314150255009	1	6,98	41
8600-2P	7314150246564	1	8,98	201
8610-2P	7314150243648	1	8,98	201
8610L-2P	7314150246700	1	12,71	202
8610SL-2P	7314150243891	1	14,11	486
8620-2P	7314150243662	1	9,04	201
8620L-2P	7314150246717	1	12,71	202
8620SL-2P	7314150243907	1	14,11	486
8620XL-1P	7314150265947	1	11,56	203
8630-2P	7314150246571	1	9,04	201
8630XL-1P	7314150265961	1	11,56	203
864000010	8413345137638	1	21,01	540
864000020	7314150330171	1	11,98	541
8640002450	8413345129022	50	68,33	540
864100010	8413345137621	1	12,08	541
864102400	8413345129015	1	65,63	541
865-1	7311518292744	10	19,98	536
87	7314150005406	1	291,37	41
87-1	7314150255016	1	10,42	41
87-2	7314150255023	1	7,32	41
8703-2P	7314150246632	1	9,26	202
8704-2P	7314150246649	1	9,26	202
8705-2P	7314150246656	1	9,26	202
8706-2P	7314150246663	1	9,26	202
8710SL-2P	7314150245772	1	20,92	486
8720SL-2P	7314150245789	1	20,92	486
874002000	8413345024938	5	10,26	591
874002500	8413345024945	5	11,24	591
874003000	8413345024952	5	12,68	591
874003500	8413345024969	5	14,05	591
874004000	8413345024976	5	17,66	591
874005000	8413345024983	5	21,06	591
874102000	8413345080989	6	16,44	591
874102500	8413345081009	5	17,30	591
874103000	8413345081023	5	18,49	591
874103500	8413345081047	4	19,78	591
874104000	8413345081061	5	22,63	591
8746002000	8413345024990	5	8,59	591
874602500	8413345025003	5	9,54	591
874603000	8413345025065	5	10,72	591
874603500	8413345025072	5	12,20	591
874604000	8413345025089	5	14,60	591
874916X16	7314150489787	1	5,47	592
874918X18	7314150489800	1	5,47	592
874923X13	7314150489763	1	5,47	592
874926X7	7314150489749	1	5,47	592
876002000	8413345025119	10	9,25	592
876002500	8413345025126	5	9,65	592
877002400	8413345025140	25	16,86	592
8800-2P	7314150246588	1	8,98	201
8810-2P	7314150243655	1	8,98	201
8810L-2P	7314150246724	1	12,71	202
8810SL-2P	7314150243914	1	14,11	486
8820-2P	7314150243679	1	9,04	201
8820L-2P	7314150246731	1	12,71	202
8820SL-2P	7314150243921	1	14,11	486
8820XL-1P	7314150265954	1	11,56	203
8821MB	7314150220571	1	852,99	80
8830-2P	7314150246595	1	9,04	201
8830XL-1P	7314150265978	1	11,56	203
8840M	7314151105495	1	1.241,00	80
8845DM	7314151105525	1	591,83	80
8845NM	7314151810955	1	601,25	79
8900DM-19	7314151105730	1	18,32	103
8900DM-21	7314150166367	5	15,82	103
8900DM-22	7314151105754	1	18,86	103
8900DM-23	7314150166374	1	17,86	103
8900DM-24	7314151105778	1	20,20	103
8900DM-25	7314151105785	1	19,62	103
8900DM-26	7314150219797	1	17,71	103
8900DM-27	7314151105822	1	20,59	103
8900DM-28	7314151105846	1	21,60	103
8900DM-29	7314150219803	1	20,31	103
8900DM-30	7314151105884	5	23,07	103
8900DM-32	7314151105891	1	24,06	103
8900DM-33	7314150166398	1	23,68	103
8900DM-34	7314151838478	1	25,60	103
8900DM-35	7314150219810	1	23,68	103
8900DM-36	7314151105914	1	27,83	103
8900DM-37	7314150166404	1	28,53	103
8900DM-38	7314150219827	1	32,67	103
8900DM-40	7314150166411	1	35,14	103
8900DM-41	7314151105938	5	32,63	103
8900DM-42	7314150166428	1	35,13	103
8900DM-46	7314151105952	1	38,50	103
8900DM-47	7314150166435	1	36,11	103
8900DM-50	7314151105969	5	43,87	103
8900DM-52	7314150166442	1	46,00	103
8900DM-54	7314150166459	3	46,00	103
8900DM-55	7314151105983	1	52,80	103





8900DM-56	7314150166466	1	53,86	103
8900DM-60	7314151106003	5	58,69	103
8900DZ-1	7314151106058	1	20,33	104
8900DZ-1.1/16	7314151106065	1	21,00	104
8900DZ-1.1/2	7314151106133	1	29,84	104
8900DZ-1.1/4	7314151106096	1	24,34	104
8900DZ-1.1/8	7314151106072	1	22,02	104
8900DZ-1.11/16	7314150166282	1	34,88	104
8900DZ-1.13/16	7314151106188	1	39,00	104
8900DZ-1.3/16	7314151106089	1	24,33	104
8900DZ-1.3/4	7314151106171	1	39,00	104
8900DZ-1.3/8	7314151106119	1	26,40	104
8900DZ-1.5/16	7314151106102	5	26,40	104
8900DZ-1.5/8	7314151106157	1	33,61	104
8900DZ-1.7/16	7314151106126	1	27,77	104
8900DZ-1.7/8	7314151106195	1	44,41	104
8900DZ-1.9/16	7314150166299	1	34,47	104
8900DZ-13/16	7314150166305	1	16,82	104
8900DZ-15/16	7314151106034	1	20,17	104
8900DZ-2	7314151106201	1	44,41	104
8900DZ-2.1/16	7314150166312	1	44,30	104
8900DZ-2.1/4	7314150166329	1	46,25	104
8900DZ-2.1/8	7314150166336	1	44,31	104
8900DZ-2.3/16	7314150358670	1	50,42	104
8900DZ-2.3/8	7314150166350	1	55,71	104
8900DZ-3/4	7314150166381	1	12,90	104
8900DZ-31/32	7314150358663	1	23,24	104
8900DZ-7/8	7314150166473	1	20,42	104
8900SM-19	7314150166633	1	18,57	103
8900SM-22	7314151810795	1	18,57	103
8900SM-23	7314150219834	1	18,57	103
8900SM-24	7314151810801	5	19,93	103
8900SM-26	7314150219841	5	20,20	103
8900SM-27	7314151810818	5	20,59	103
8900SM-28	7314150166657	1	20,59	103
8900SM-29	7314150219858	1	23,07	103
8900SM-30	7314151810825	5	23,07	103
8900SM-32	7314151810832	5	24,06	103
8900SM-33	7314150166671	1	24,06	103
8900SM-34	7314151838461	1	25,60	103
8900SM-35	7314150166688	1	25,60	103
8900SM-36	7314151810849	5	27,83	103
8900SM-38	7314151810856	1	29,61	103
8900SM-41	7314151810863	5	32,63	103
8900SM-42	7314150219865	1	32,63	103
8900SM-46	7314151810870	1	38,50	103
8900SM-50	7314151810887	1	43,88	103
8900SM-55	7314151810894	1	52,79	103
8900SM-60	7314151810900	1	58,69	103
8900SZ-1*	7314150166480	1	24,73	103
8900SZ-1.7/16*	7314150166589	1	31,05	103
8900SZ-1.7/8*	7314150166596	1	43,01	103
8900SZ-1.9/16*	7314150166602	1	32,35	103
8900SZ-13/16*	7314150166619	1	22,56	103
8900SZ-2*	7314150166640	1	46,87	103
8900SZ-3/4*	7314150166664	1	16,35	103
89049TM-1000	7314150415403	1	1.623,05	119
8905-TM	7314150125470	1	1.538,48	120
8910-2P	7314150243709	1	8,98	202
8910SL-2P	7314150243938	1	15,69	486
8915-2P	7314150243716	1	8,98	202
8915L-2P	7314150258765	1	13,75	202
8915SL-2P	7314150243945	1	15,69	486
8920-2P	7314150243723	1	9,04	202
8920L-2P	7314150258772	1	13,75	202
8920SL-2P	7314150243952	1	15,69	486
89222CR-1000	7314150415441	1	3.145,46	120
8925-2P	7314150243730	1	9,04	202
8925L-2P	7314150258789	1	13,75	202
8925SL-2P	7314150243969	1	15,69	486
8927-2P	7314150243747	1	9,04	202
8927L-2P	7314150263516	1	13,75	202
8930-2P	7314150243754	1	9,14	202
8930L-2P	7314150258796	1	13,75	202
8930SL-2P	7314150243976	1	15,69	486
8940-2P	7314150243761	1	9,14	202
894M-10	7314151833039	10	3,53	53
894M-100	7314151833305	1	328,94	53
894M-105	7314151833312	1	429,65	53
894M-11	7314151833046	10	3,63	53
894M-110	7314151833329	1	480,10	53
894M-115	7314151833336	1	544,55	53
894M-12	7314151833053	10	3,63	53
894M-120	7314151833343	1	572,75	53
894M-125	7314150132478	1	660,90	53
894M-13	7314151833060	10	3,63	53
894M-130	7314150132485	1	684,68	53
894M-135	7314150132492	1	767,64	53
894M-14	7314151833077	10	4,24	53
894M-15	7314151833084	10	4,40	53
894M-16	7314150139569	10	4,70	53
894M-17	7314151833091	10	3,63	53
894M-19	7314151833107	10	4,92	53
894M-21	7314150223220	5	5,29	53
894M-22	7314151833114	5	6,13	53
894M-24	7314151833121	5	7,39	53

\* Hasta agotar existencias



894M-27	7314151833138	5	8,44	53
894M-30	7314151833145	5	9,94	53
894M-32	7314151833152	5	11,21	53
894M-34	7314150139583	1	18,63	53
894M-36	7314151833169	5	14,57	53
894M-38	7314151833176	1	22,72	53
894M-41	7314151833183	1	23,12	53
894M-46	7314151833190	1	26,16	53
894M-50	7314151833206	1	32,76	53
894M-55	7314151833213	1	38,71	53
894M-60	7314151833220	1	54,55	53
894M-65	7314151833237	1	65,44	53
894M-7	7314151833008	10	3,53	53
894M-70	7314151833244	1	76,43	53
894M-75	7314151833251	1	131,62	53
894M-8	7314151833015	10	3,53	53
894M-80	7314151833268	1	155,39	53
894M-85	7314151833275	1	189,66	53
894M-9	7314151833022	10	3,63	53
894M-90	7314151833282	1	212,12	53
894M-95	7314151833299	1	322,67	53
8950NA-SO/2*	7314151816605	1	102,69	105
8950RN	7314150522675	1	132,93	105
8950RNA	7314150521258	1	116,70	105
8951	7314151106782	1	357,33	105
8951-M	7314150124916	1	245,04	121
8953-16	7314150538300	1	36,67	104
8953E-32	7314150509447	1	80,31	104
8954-15	7314150522774	1	71,30	104
8954A	7314151106812	1	37,76	104
8955N	7314150434114	1	120,60	105
8955N-SPARE	7314150434121	1	50,77	105
8955N/A	7314150434053	1	95,21	105
8955N/B	7314150434176	5	33,95	105
8957-19	7314150522781	1	97,08	104
8957A	7314150510580	1	78,80	104
8958A*	7314151106836	1	95,74	104
895M-10-11	7314151832742	10	3,53	51
895M-10-13	7314151832759	10	3,53	51
895M-13-17	7314151832803	10	4,24	51
895M-17-19	7314151832827	10	5,23	51
895M-19-22	7314151832834	10	6,41	51
895M-19-24	7314151832841	5	7,33	51
895M-22-24	7314151832858	5	7,68	51
895M-24-27	7314151832865	5	10,19	51
895M-24-30	7314151832872	5	12,09	51
895M-27-32	7314151832889	5	14,63	51
895M-30-32	7314151832896	5	15,40	51
895M-30-36	7314151832902	1	20,62	51
895M-32-36	7314151832919	1	20,62	51
895M-36-41	7314151832926	1	28,56	51
895M-41-46	7314151832933	1	34,75	51
895M-46-50	7314151832940	1	41,76	51
895M-50-55	7314151832957	1	55,05	51
895M-55-60	7314151832964	1	69,44	51
895M-6-7	7314151832711	10	3,57	51
895M-65-70	7314151832971	1	136,67	51
895M-8-10	7314151832735	10	3,23	51
895M-8-9	7314151832728	10	3,23	51
8960-16	7314150492855	12	50,08	104
8960-8	7314150492862	1	40,20	104
8963	7314150181087	1	40,75	104
8966	7314151106898	1	97,49	104
8967	7314153003591	1	33,63	99
8967/S3	7314153003607	1	87,69	85
8971	7314150492879	1	27,48	105
8972	7314150492886	1	30,71	105
9-12-51/3806-KP	7311518044558	5	19,08	619
9-462-14-0-0*	7311518020873	5	58,53	37
9-467-00-0-0	7311518020897	1	44,54	37
9-469-00-0-0	7311518020903	1	16,95	37
9-484-3-2-10	7311518193348	10	1,83	37
9-484-3-2-1P	7311518193522	10	3,16	37
9-484-5-2-10	7311518193355	10	1,83	37
9-484-5-2-1P	7311518193331	10	3,16	37
9-485-04-10	7314150271672	10	3,16	37
9-485-04-1P	7314150271665	10	3,16	37
9-485-05-10	7314150271696	10	3,16	37
9-485-05-1P	7314150271689	10	3,16	37
9-485-06-10	7311518193508	10	3,44	37
9-485-06-1P	7311518193492	20	4,64	37
9-485-09-10	7311518193386	10	3,44	37
9-485-09-1P	7311518193362	20	4,64	37
9-485-13-10	7311518193393	10	3,44	37
9-485-13-1P	7311518193379	1	4,64	37
9-486-04-10	7311518193430	10	3,44	38
9-486-04-1P	7311518193409	20	4,64	38
9-486-05-10	7311518193461	10	3,44	38
9-486-05-1P	7311518193447	20	4,64	38
9-486-07-10	7311518249373	10	3,45	38
9-486-07-1P	7311518249359	20	4,64	38
9-486-08-10	7311518270933	10	4,62	38
9-486-C-10	7311518209599	10	3,29	38
9-486-C-1P	7311518209605	10	4,39	38
9-488-02-10	7311518194772	10	2,62	37
900T-020-100	7314153018106	5	10,72	222





# 900T-025-100

			€	
900T-025-100	7314153018113	5	10,72	222
900T-030-100	7314153018120	5	10,72	222
900T-040-150	7314153018137	5	11,98	222
900T-050-150	7314153018144	5	12,45	222
900T-060-200	7314153018151	5	13,24	222
900T-080-200	7314153018168	5	14,51	222
900T-100-200	7314153018175	5	16,08	222
901T-006-100	7314153018182	5	7,77	222
901T-007-100	7314153018199	5	7,77	222
901T-008-100	7314153018205	5	7,77	222
901T-009-100	7314153018212	5	7,77	222
901T-010-100	7314153018229	5	11,01	222
901T-015-150	7314153018236	5	11,21	222
901T-020-150	7314153018243	5	11,21	222
901T-025-150	7314153018250	5	12,29	222
901T-027-150	7314153018267	5	12,29	222
901T-030-200	7314153018274	5	13,24	222
901T-040-200	7314153018281	5	13,85	223
901T-045-200	7314153018298	5	13,85	223
901T-050-200	7314153018304	5	13,85	223
9029	7314153010612	5	31,44	40
9029 C	7314153010629	5	36,85	40
9029-1	7314150239580	1	6,17	41
9029-2	7314150238668	1	3,53	41
9029-T	7314150189076	5	36,26	40
9029T-1	7314150312139	1	13,75	41
902T-050-150	7314153018311	5	12,86	223
902T-055-150	7314153018328	5	12,86	223
902T-060-150	7314153018335	5	13,72	223
902T-070-175	7314153018342	5	14,51	223
902T-080-175	7314153018359	5	14,79	223
902T-090-175	7314153018366	5	14,79	223
902T-100-175	7314153018373	5	15,76	223
902T-110-175	7314153018380	5	15,76	223
902T-120-175	7314153018397	5	17,65	223
902T-130-175	7314153018403	5	18,60	223
9031	7314150110988	5	34,17	40
9031 C	7314150113507	5	39,52	40
9031 P-1	7314150266302	1	8,65	41
9031-1	7314150239597	1	5,97	41
9031-8224	7314150321193	3	89,02	261
9031-T	7314150131648	5	42,19	40
9031P	7314150187539	5	37,02	40
9031T-1	7314150312146	1	13,86	41
9033	7314150181414	5	44,57	40
9033-1	7314150353804	1	13,04	41
9035	7314150181421	5	64,60	40
9035-1	7314150353811	1	14,57	41
903T-1	7314153018410	1	78,96	222
903T-2	7314153018427	1	72,86	222
903T-3	7314153018434	1	90,26	222
9045-B-200	7311518012175	6	26,32	532
9045-B-250	7311518012182	6	27,85	532
9045-B-300	7311518012199	6	30,37	532
9045-B-400	7311518178123	1	35,42	532
9048-200	7314150138159	10	21,15	532
9048-250	7314150138166	10	21,88	532
9048-300	7314150138173	10	24,99	532
9048-350	7314150180349	10	25,02	532
9048-400	7314150138180	10	26,48	532
904T-060-150	7314153019837	5	19,79	223
905T-060-100	7314153019844	5	16,56	223
9060	7314150545247	1	154,50	628
9061	7314150545254	1	164,80	628
9070	7314150100170	5	29,98	40
9070 P	7314150103416	5	33,57	40
9070 P-1	7314150239610	1	8,40	41
9070 PC	7314150103423	5	29,92	40
9070C	7314150100187	5	27,15	40
9071	7314150100194	5	32,56	40
9071 P	7314150103430	5	35,83	40
9071 P-1	7314150239627	1	8,21	41
9071 PC	7314150103447	5	32,04	40
9071C	7314150100200	5	29,08	40
9072	7314150055609	5	42,39	40
9072 C	7314150055616	5	37,45	40
9072 P	7314150056354	5	45,95	40
9072 P-1	7314150239634	1	9,03	41
9072 PC	7314150056361	5	40,23	40
9073	7314150101702	5	61,66	40
9073 C	7314150101719	3	54,67	40
9073 P	7314150101726	5	65,23	40
9073 P-1	7314150239641	1	10,25	41
9073 PC	7314150101733	3	57,44	40
91-023-5P	7311518032593	1	4,54	144
91-027-5P	7311518032616	1	5,96	144
91-143-100P	7311518224363	1	114,87	144
91-143-25P	7311518266578	1	28,69	144
91-143-5P	7311518032630	1	6,28	144
91-148-5P	7311518032654	1	7,36	144
91-223-5P	7311518032661	1	6,61	144
91-226-5P	7311518032685	1	9,26	144
91-233-5P	7311518260057	1	8,94	144
91-243-5P	7311518032692	1	7,43	144
91-2PW-5P	7311518260163	1	10,83	144
91-3PM-5P	7311518260156	1	8,76	144

			€	
91-412-5P	7311518260040	1	13,93	144
91-433-5P	7311518260101	1	13,42	144
91-434-5P	7311518260026	1	18,41	144
91-443-5P	7311518032722	1	19,23	144
91-444-5P	7311518260033	1	19,67	144
91-4PWM-5P	7311518260170	1	13,70	144
91-502-5P	7311518032746	1	7,43	144
91-512-25P	7311518266592	1	36,18	144
91-512-5P	7311518032753	1	9,11	144
91-517-5P	7311518032777	1	8,19	144
91-522-5P	7311518032784	1	7,68	144
91-611-5P	7311518260071	1	9,90	144
91-612-5P	7311518032814	1	8,00	144
91-622-5P	7311518260088	1	9,29	144
91-623-5P	7311518260064	1	13,93	144
91-7V1-5P	7311518260118	1	17,03	144
91-METAL-10P	7314150449477	1	19,38	144
91-MIXED-10P	7314150449491	1	18,56	144
91-WOOD-10P	7314150449446	1	16,91	144
91C	7314150182381	5	28,22	42
92-001-1P	7314150474998	90	33,35	146
92-106-1P	7314150474899	90	26,93	145
92-113-1P	7314150474912	90	24,32	145
92-118-1P	7314150474950	90	47,92	146
92-133-1P	7314150474134	70	18,81	144
92-133-25P	7314150539246	1	386,25	144
92-133-3P	7314150474158	46	49,36	144
92-136-1P	7314150474783	20	30,56	146
92-136-G120-5P	7314150498079	10	4,11	146
92-136-G240-5P	7314150498116	10	4,11	146
92-136-G40-5P	7314150497997	10	4,11	146
92-136-G80-5P	7314150498031	10	4,11	146
92-137-1P	7314150475070	50	12,66	146
92-137-G120-5P	7314150498093	10	4,11	146
92-137-G240-5P	7314150498130	10	4,11	146
92-137-G40-5P	7314150498017	10	4,11	146
92-137-G80-5P	7314150498055	10	4,11	146
92-151-25P	7314150539345	1	401,70	145
92-152-25P	7314150539352	1	432,60	145
92-157-1P	7314150474820	70	15,29	145
92-157-25P	7314150539314	1	309,00	145
92-160-1P	7314150474172	70	17,63	145
92-160-25P	7314150539253	1	375,95	145
92-160-3P	7314150474196	46	54,06	145
92-165-1P	7314150475018	90	10,88	146
92-166-1P	7314150474974	50	81,27	146
92-174-1P	7314150474936	90	47,92	145
92-205-1P	7314150474219	70	21,16	144
92-205-25P	7314150539277	1	528,86	144
92-205-3P	7314150474356	46	60,29	144
92-221-1P	7314150474721	70	18,81	145
92-221-25P	7314150474592	70	19,39	145
92-222-25P	7314150539284	1	375,95	145
92-222-3P	7314150474370	46	55,27	145
92-223-1P	7314150474684	70	19,98	145
92-223-25P	7314150539321	1	412,00	145
92-223-3P	7314150474400	46	53,47	145
92-225-1P	7314150474707	70	15,86	144
92-225-25P	7314150539291	1	309,00	144
92-226-1P	7314150475032	90	20,28	146
92-228-1P	7314150474745	70	17,63	145
92-228-25P	7314150539307	1	309,00	145
92-229-1P	7314150474769	70	17,63	144
92-236-1P	7314150474806	70	30,56	145
92-236-25P	7314150539338	1	690,10	145
92-245-1P	7314150475056	90	31,56	146
92-251-1P	7314150474868	70	26,12	146
92-WM-SET-8P	7314150486830	34	123,52	146
9210	7311518278182	1	257,42	624
9210-1	7311518278212	1	55,86	624
9210-10	7311518278229	1	104,84	624
9210-1060177	7311518295424	1	0,93	625
9210-1060238	7311518295394	20	0,48	625
9210-1230219	7311518295387	20	6,98	625
9210-1230235	7311518295325	1	8,09	624
9210-1320281	7311518295431	10	9,30	625
9210-1640142	7311518295356	1	8,70	624
9210-1690148	7311518295332	1	19,86	624
9210-1700118	7311518295363	1	42,07	625
9210-1710266	7311518295417	1	68,75	625
9210-1720100	7311518295295	1	11,47	624
9210-1730107	7311518295349	10	13,81	624
9210-1770106	7311518295370	10	5,79	625
9210-1830137	7311518295400	1	9,22	625
9210-20	7311518278236	1	14,41	624
92C	7314150182398	5	32,18	42
93C	7314150182404	5	38,18	42
94C	7314150182411	5	48,79	42
9500DZ-1.13/16	7314150227501	1	41,31	106
9500DZ-1.5/8	7314150227495	1	35,45	106
9500DZ-1.7/8	7314150227518	1	41,31	106
9500DZ-2	7314150227525	1	54,25	106
9500DZ-2.1/2	7314150227570	1	62,43	106
9500DZ-2.1/4	7314150227556	1	54,25	106
9500DZ-2.1/8	7314150227532	1	54,25	106
9500DZ-2.15/16	7314150227617	1	84,82	106

			€	
9500DZ-2.3/16	7314150227549	1	54,25	106
9500DZ-2.3/4	7314150227600	1	70,98	106
9500DZ-2.3/8	7314150227563	1	62,43	106
9500DZ-2.5/8	7314150227594	1	72,33	106
9500DZ-2.9/16	7314150227587	1	62,43	106
9500DZ-3	7314150227624	1	97,45	106
9500DZ-3.1/8	7314150227631	1	97,45	106
9500SM-41	7314153013699	1	48,08	106
9500SM-46	7314153013705	1	56,07	106
9500SM-50	7314153013712	1	62,03	106
9500SM-54	7314153013729	1	66,11	106
9500SM-55	7314153013736	1	70,61	106
9500SM-58	7314153013743	1	77,17	106
9500SM-60	7314153013750	1	86,24	106
9500SM-63	7314153013767	1	96,67	106
9500SM-65	7314153013774	1	103,08	106
9500SM-67	7314153013781	1	109,79	106
9500SM-70	7314153013798	1	115,81	106
9500SM-71	7314153013804	1	121,89	106
9500SM-75	7314153013811	1	129,63	106
9500SM-77	7314153013828	1	137,87	106
9500SM-80	7314153013835	1	147,62	106
9500SM-82	7314153013842	1	157,39	106
9505-3400	7314150125517	1	4.007,39	120
9505-TM	7314150125487	1	1.538,48	120
95155B-3000	7314150415410	1	4.466,54	120
9525-10	7311518031817	1	19,16	162
9525-3400	7314150125524	1	7.425,05	120
9525-7	7311518031800	1	15,06	162
9525CR-4000	7314150415465	1	5.020,15	120
9526B-4500	7314150415427	1	4.655,28	120
9527CR-2000	7314150415458	1	3.460,01	120
9540DZ	7314150414048	1	1.398,81	80
9540DZL	7314150414055	1	1.914,71	81
9540MB	7314153014108	1	1.189,37	80
9540MBL	7314153014115	1	1.758,73	80
9550N	7314150424160	1	270,92	106
9550N-SPARE	7314150424153	1	76,17	107
9550N/A	7314150424146	1	222,19	107
9550N/B	7314150424788	1	55,55	106
9555	7314153014047	1	103,07	106
9555AB	7314153014061	1	48,15	106
956	7314150025190	1	5,58	560
9560AB	7314153014078	1	77,98	106
9563AB	7314153014085	1	99,90	106
9565AB	7314153014092	1	52,11	106
9572*	7314150178599	5	49,64	42
9572-200	7311518004231	20	26,29	532
9572-250	7311518004248	20	27,88	532
9574-200	7314150138197	10	21,49	532
9574-250	7314150138203	10	22,04	532
9574-300	7314150180356	10	23,33	532
9575-250	7314150185894	6	32,58	532
95C	7314150182428	1	81,66	42
960100010	8413345031073	1	38,19	448
960100020	8413345031080	1	41,36	448
960100030	8413345031097	1	44,96	448
960100050	8413345031103	1	52,90	448
960100060	8413345031110	1	57,25	448
9625-6.35QC	7314150441716	1	27,92	162
9625-9500	7314150125555	1	6.630,63	120
96255CR-7000	7314150415489	1	6.284,62	120
9626-10	7314150388844	1	16,92	160
9626-11	7314150388851	1	17,21	160
9626-12	7314150388868	1	17,59	160
9626-13	7314150388875	1	18,05	160
9626-14	7314150388882	1	18,59	160
9626-15	7314150444526	1	19,42	160
9626-16	7314150388899	1	21,29	160
9626-18	7314150388905	1	27,17	160
9626-20	7314150388912	1	30,80	160
9626-22	7314150388929	1	34,42	160
9626-23	7314150388936	1	36,09	160
9626-24	7314150388943	1	37,73	160
9626-25	7314150388950	1	39,46	160
9626-26	7314153024237	1	41,18	160
9626-28	7314150388967	1	48,61	160
9626-30	7314150388974	1	69,59	160
9626-32	7314150388981	1	69,59	160
9626-35	7314150444533	1	69,59	160
9626-6	7314150388806	1	15,14	160
9626-7	7314150388813	1	15,56	160
9626-8	7314150388820	1	15,94	160
9626-9	7314150388837	1	16,55	160
9627-10-460	7314150389018	1	26,69	160
9627-12-460	7314150389025	1	27,03	160
9627-14-460	7314150389032	1	29,11	160
9627-16-460	7314150389049	1	30,49	160
9627-18-460	7314150389056	1	35,35	160
9627-20-460	7314150389063	1	39,85	160
9627-22-460	7314150389070	1	41,58	160
9627-24-460	7314150389087	1	45,06	160
9627-26-460	7314150389094	1	48,51	160
9627-28-460	7314150389101	1	50,24	160
9627-30-460	7314150389108	1	61,49	160
9627-32-460	7314150389124	1	69,30	160

\* Hasta agotar existencias

			€	
9627-6-460	7314150388998	1	25,99	160
9627-8-460	7314150389001	1	26,35	160
9629-10	7314150388479	1	6,19	161
9629-12	7314150388486	1	6,19	161
9629-13	7314150440238	1	5,87	161
9629-14	7314150388493	1	6,57	161
9629-16	7314150388509	1	6,57	161
9629-17	7314150440245	1	6,57	161
9629-18	7314150388516	1	6,57	161
9629-19	7314150440252	1	6,57	161
9629-20	7314150388523	1	7,16	161
9629-22	7314150388530	1	7,16	161
9629-24	7314150388547	1	7,16	161
9629-25	7314150388554	1	7,16	161
9629-26	7314150388561	1	6,79	161
9629-28	7314150388578	1	11,18	161
9629-30	7314150388585	1	11,22	161
9629-32	7314150388592	1	11,27	161
9629-35	7314150440269	1	11,07	161
9629-36	7314150388608	1	11,99	161
9629-38	7314150388615	1	13,16	161
9629-40	7314150388622	1	13,16	161
9629-6	7314150388417	1	7,28	161
9629-8	7314150388462	1	5,44	161
9629-SET-8	7314150441648	12	31,73	161
9631-10-400	7314150388684	1	10,48	161
9631-12-400	7314150388691	1	11,62	161
9631-13-400	7314150447572	1	9,06	161
9631-14-400	7314150388707	1	9,93	161
9631-16-400	7314150388714	1	10,94	161
9631-18-400	7314150388721	1	12,33	161
9631-19-400	7314150447589	1	11,17	161
9631-20-400	7314150388738	1	12,33	161
9631-22-400	7314150388745	1	14,27	161
9631-24-400	7314150388752	1	15,32	161
9631-25-400	7314150432066	1	14,94	161
9631-28-400	7314150388776	1	18,58	161
9631-30-400	7314150388783	1	19,67	161
9631-32-400	7314150388790	1	22,27	161
9631-35-400	7314150447596	1	20,28	161
9631-38-400	7314150447602	1	20,42	161
9631-6-400	7314150388646	1	9,96	161
9631-8-400	7314150388677	1	9,96	161
9646-10	7314150388264	1	6,78	161
9646-10-250	7314150388387	1	7,30	161
9646-11	7314150388288	1	7,84	161
9646-12	7314150388295	1	9,99	161
9646-12-250	7314150388400	1	10,54	161
9646-13	7314150388301	1	10,68	161
9646-14	7314150388318	1	12,47	161
9646-15	7314150388325	1	13,20	161
9646-16	7314150388332	1	13,20	161
9646-18	7314150388349	1	19,63	161
9646-20	7314150388356	1	19,63	161
9646-3	7314150388189	1	3,56	161
9646-4	7314150388202	1	3,92	161
9646-5	7314150388219	1	4,27	161
9646-6	7314150388226	1	4,64	161
9646-6-250	7314150388363	1	5,17	161
9646-7	7314150388233	1	5,00	161
9646-8	7314150388240	1	5,72	161
9646-8-250	7314150388370	1	6,25	161
9646-9	7314150388257	1	6,25	161
9646-SET-5	7314150441686	1	10,96	161
9646-SET-8	7314150441693	1	14,21	161
9656-SET-6	7314150486953	1	67,27	161
9666-10-400	7314150540303	1	14,70	160
9666-10-600	7314150540389	1	14,89	160
9666-12-400	7314150540310	1	17,35	160
9666-12-600	7314150540396	1	17,57	160
9666-14-400	7314150540327	1	18,74	160
9666-14-600	7314150540402	1	19,55	160
9666-16-400	7314150540334	1	21,96	160
9666-16-600	7314150540419	1	23,24	160
9666-20-400	7314150540341	1	32,78	160
9666-20-600	7314150540426	1	34,69	160
9666-22-400	7314150540358	1	40,37	160
9666-22-600	7314150540433	1	41,96	160
9666-6-400	7314150540280	1	11,83	160
9666-6-600	7314150540365	1	11,89	160
9666-8-400	7314150540297	1	11,83	160
9666-8-600	7314150540372	1	11,89	160
96C	7314150134120	1	155,21	42
97-1	7314150366637	1	49,05	123
97-1/2	7314150366645	1	29,69	123
97-1/4	7314150366650	1	29,69	123
97-10	7314150366286	1	28,39	123
97-11	7314150366293	1	28,39	123
97-11/16	7314150366583	1	29,69	123
97-12	7314150366309	1	28,39	123
97-13	7314150366316	1	28,39	123
97-13/16	7314150366606	1	46,46	123
97-14	7314150366323	1	28,38	123
97-15	7314150366330	1	28,38	123
97-15/16	7314150366620	1	49,05	123
97-16	7314150366347	1	28,39	123





97-17	7314150366354	1	28,39	123
97-17/32	7314150366552	1	29,69	123
97-18	7314150366361	1	28,39	123
97-19	7314150366378	1	28,39	123
97-21	7314150366385	1	47,59	123
97-22	7314150349722	1	54,82	123
97-24	7314150357048	1	54,82	123
97-27	7314150366392	1	50,22	123
97-3/4	7314150366590	1	29,69	123
97-3/8	7314150366521	1	29,69	123
97-30	7314150366408	1	49,05	123
97-32	7314150366415	1	49,05	123
97-5/16	7314150366514	1	29,69	123
97-5/8	7314150366576	1	29,69	123
97-7	7314150366255	1	28,39	123
97-7/16	7314150366538	1	29,69	123
97-7/8	7314150366613	1	46,46	123
97-8	7314150366262	1	28,39	123
97-9	7314150366279	1	28,39	123
97-9/16	7314150366569	1	29,69	123
9710-10-175	7314151785789	5	11,90	223
9710-3-5-75	7314151785192	10	5,61	223
9710-5-5-100	7314151785352	10	7,46	223
9710-6-5-125	7314151785437	10	8,61	223
9710-8-150	7314151785512	5	9,93	223
9710/S6	7314151802301	1	53,72	224
9715-14-250	7314153010148	5	46,01	225
9733	7314150103256	1	398,28	261
9778-1	7314151793524	10	8,09	224
9778-2	7314151793531	10	11,05	224
9778-3	7314151793548	5	14,91	224
9778PZD-1	7314151823535	10	8,44	224
9778PZD-2	7314151823542	10	11,49	224
97C	7314150128211	1	303,27	42
98-1/2	7314150367481	1	30,98	124
98-1/4	7314150367443	1	30,98	124
98-10	7314150367320	1	30,98	124
98-11	7314150367337	1	30,98	124
98-11/16	7314150367511	1	30,98	124
98-12	7314150367344	1	30,98	124
98-13	7314150367351	1	30,98	124
98-13/16	7314150367535	1	32,27	124
98-14	7314150367368	1	30,98	124
98-15	7314150367375	1	30,98	124
98-16	7314150367382	1	30,98	124
98-17	7314150367399	1	30,98	124
98-18	7314150367405	1	30,98	124
98-19	7314150367412	1	30,98	124
98-21	7314150367429	1	30,98	124
98-22	7314150367436	1	30,98	124
98-3/4	7314150367528	1	30,98	124
98-3/8	7314150367467	1	30,98	124
98-5/16	7314150367450	1	30,98	124
98-5/8	7314150367504	1	30,98	124
98-7	7314150367290	1	30,98	124
98-7/16	7314150367474	1	30,98	124
98-7/8	7314150367542	1	32,27	124
98-8	7314150367306	1	30,98	124
98-9	7314150367313	1	30,98	124
98-9/16	7314150367498	1	30,98	124
981001100	7314150219902	1	1.585,76	436
982000170	7314150219926	1	463,34	450
982000320	7314150219919	1	463,12	451
982000350	7314150219933	1	521,86	451
983000320	7314150219940	1	541,76	429
983100320	7314150219964	1	579,07	429
984010320	7314150219971	1	838,43	429
9841	7314150107445	1	811,66	452
9848	7314150111015	1	163,80	451
98505*	7314150216321	5	34,26	221
9852	7314150114092	1	381,76	452
9853	7314150103287	1	82,96	262
9855	7314150111848	1	103,76	637
9857	7314150114283	1	81,08	637
9858	7314150111862	1	30,13	637
9859	7314150113057	1	69,63	637
9860	7314150522859	1	159,36	637
9861	7314150522873	1	70,96	638
9862	7314150522897	1	56,09	638
9863	7314150522910	1	95,00	638
9873	7314150058082	1	55,98	261
9883	7314150043293	1	146,50	559
9897	7314150058068	1	140,42	262
9897G/3	7314150470020	1	84,45	262
9897S/3	7314150470044	1	95,58	491
99-1/2	7314150368150	1	34,86	124
99-10	7314150368013	1	32,27	125
99-11	7314150368020	1	32,27	125
99-11/16	7314150368181	1	36,13	124
99-12	7314150368037	1	32,27	125
99-13	7314150368044	1	32,27	125
99-14	7314150368051	1	32,27	125
99-16	7314150368068	1	33,55	125
99-17	7314150368075	1	33,55	125
99-18	7314150368082	1	33,55	125
99-19	7314150368099	1	33,55	125



99-21	7314150368105	1	33,55	125
99-22	7314150368112	1	33,55	125
99-24	7314150368129	1	37,43	125
99-3/4	7314150368198	1	36,13	124
99-3/8	7314150368136	1	34,86	124
99-5/8	7314150368174	1	34,86	124
99-7/16	7314150368143	1	34,86	124
99-9/16	7314150368167	1	34,86	124
9938	7314150056491	1	222,69	255
9A-14	7314150368204	1	60,66	125
9B-1/4	7314150366071	1	61,93	122
9B-5/16	7314150366088	1	83,88	122
9F-1/2	7314150366194	1	41,29	122
9F-1/4	7314150366170	1	40,02	122
9F-3/8	7314150366187	1	40,02	122
9P-1/2	7314150366057	1	91,63	122
9P-1/4	7314150366033	1	86,48	122
9P-3/8	7314150366040	1	89,05	122
9Q-1/2	7314150366019	1	105,82	122
9Q-1/4	7314150365999	1	100,65	122
9Q-3/8	7314150366002	1	103,25	122
9R-1/2	7314150365913	1	68,40	121
9R-1/4	7314150365890	1	64,52	121
9R-3/8	7314150365906	1	67,11	121
9T-1/2	7314150366118	1	82,59	122
9T-1/4	7314150366095	1	72,28	122
9T-3/8	7314150366101	1	77,44	122
9W	7314150354399	1	41,67	125
A0313M03	7311518023706	1	14,96	149
A0313M03E	7311518192150	1	18,16	149
A0313M03X	7311518182038	1	15,57	149
A0313M03XE	7311518181475	1	18,18	149
A0313M03XE-60	7311518184513	1	23,30	149
A0313M03XE-80	7311518201357	1	23,66	149
A0314I03	7314150501243	5	13,91	153
A0613M03X	7311518197872	1	27,20	149
A0616AL06E	7311518181802	1	35,72	151
A0616M06	7311518023737	1	25,97	149
A0616M06E	7311518023751	1	29,69	149
A0616M06X	7311518023768	1	28,48	149
A0616M06XE	7311518181468	1	29,69	149
A0618I06	7314150501267	5	21,19	153
A0618S06E	7314150501786	5	21,35	152
A0625M06X	7311518197780	1	33,03	151
A0820M06	7311518023805	1	38,00	149
A0820M06E	7311518023829	1	44,02	149
A0820M06X	7311518023836	1	40,49	149
A0820M06XE	7311518181994	1	46,45	149
A1020I06	7314150501304	5	29,81	153
A1020M06	7311518023874	1	43,61	149
A1020M06E	7311518023898	1	50,25	149
A1020M06X	7311518023904	1	45,68	149
A1020M06XE	7311518182007	1	50,25	149
A1020S06	7314150501335	5	27,33	152
A1020S06E	7314150501793	5	30,06	152
A1225AL06E	7311518187620	1	65,62	151
A1225AL08E	7311518181819	1	65,62	151
A1225I06	7314150506729	5	57,08	153
A1225M06	7311518023942	1	54,63	149
A1225M06E	7311518023966	1	62,91	149
A1225M06X	7311518023973	1	60,91	149
A1225M08	7311518100506	1	57,63	149
A1225M08E	7311518100520	1	62,91	149
A1225M08X	7311518187989	1	57,73	149
A1225M08XE	7311518192174	1	66,25	149
A1225S06	7314150501427	5	42,67	152
A1225S06E	7314150501809	5	46,93	152
A1625AL08XE	7311518244033	1	108,55	151
A1625M06	7311518192181	1	68,52	149
A1625M06X	7311518187361	1	72,05	149
A1625M06XE	7311518187354	1	82,87	149
A1625M08	7311518100568	1	68,52	149
A1625M08E	7311518100582	1	82,86	149
A1625M08X	7311518100599	1	72,05	149
A1625M08XE	7311518182021	1	78,71	149
A6700DM-10	7314151821722	5	5,28	82
A6700DM-11	7314151821739	5	5,28	82
A6700DM-12	7314151821746	5	5,28	82
A6700DM-13	7314151821753	5	5,28	82
A6700DM-14	7314151821760	5	5,28	82
A6700DM-4	7314150557080	5	4,89	82
A6700DM-4.5	7314150557103	5	4,89	82
A6700DM-5	7314150220632	5	5,28	82
A6700DM-5.5	7314151821678	5	5,28	82
A6700DM-6	7314151821685	5	5,28	82
A6700DM-7	7314151821692	5	5,28	82
A6700DM-8	7314151821708	5	5,28	82
A6700DM-9	7314151821715	5	5,28	82
A6700DZ-1/2	7314151751883	5	6,78	82
A6700DZ-1/4	7314151751371	5	6,78	82
A6700DZ-11/32	7314151819842	5	6,78	82
A6700DZ-3/16	7314151751029	5	6,78	82
A6700DZ-3/8	7314151751616	5	6,78	82
A6700DZ-5/16	7314151751531	5	6,78	82
A6700DZ-7/16	7314151819859	5	6,78	82
A6700DZ-7/32	7314151751296	5	6,78	82





A6700DZ-9/16	7314151751968	5	6,78	82
A6700DZ-9/32	7314151751456	5	6,70	82
A6709M-2.5	7314151753740	1	32,90	86
A6709M-3	7314151753825	1	32,90	86
A6709M-4	7314151754129	1	32,90	86
A6709M-5	7314151754471	1	32,90	86
A6709M-6	7314151754556	1	32,90	86
A6709MZ/9	7314150512096	1	207,41	70
A6709Z-1/8	7314151755447	1	32,90	86
A6709Z-3/16	7314151755874	1	32,90	86
A6709Z-5/32	7314151755799	1	32,90	86
A6709Z-9/64	7314151755522	1	32,90	86
A6710DM-10	7314151756765	1	42,83	83
A6710DM-11	7314151756840	1	43,52	83
A6710DM-12	7314151756925	1	43,52	83
A6710DM-13	7314151757069	1	43,52	83
A6710DM-14	7314151757144	1	43,52	83
A6710DM-5.5	7314151756178	1	42,83	83
A6710DM-6	7314151756253	1	42,83	83
A6710DM-7	7314151756338	1	42,83	83
A6710DM-8	7314151756413	1	42,83	83
A6710DM-9	7314151756680	1	42,83	83
A6710DZ-1/2	7314151820466	1	43,76	83
A6710DZ-1/4	7314151757229	1	43,52	83
A6710DZ-11/32	7314151757571	1	43,52	83
A6710DZ-3/16	7314151820435	1	43,52	83
A6710DZ-3/8	7314151757656	1	43,52	83
A6710DZ-5/16	7314151757496	1	43,52	83
A6710DZ-7/16	7314151757731	1	43,76	83
A6710DZ-7/32	7314151820442	1	43,52	83
A6710DZ-9/16	7314151820473	1	43,76	83
A6710DZ-9/32	7314151820459	1	43,52	83
A6716DM	7314151820824	1	158,17	67
A6716DZ	7314151820831	1	170,34	70
A6718DZ	7314150312450	1	187,41	70
A6800DM-10	7314151821845	1	12,41	82
A6800DM-11	7314151821852	1	12,41	82
A6800DM-12	7314151821869	1	12,41	82
A6800DM-13	7314151821876	1	12,41	82
A6800DM-14	7314151821883	1	12,41	82
A6800DM-4	7314151821777	1	12,41	82
A6800DM-5	7314151821784	1	12,41	82
A6800DM-5.5	7314151821791	1	12,41	82
A6800DM-6	7314151821807	1	12,41	82
A6800DM-7	7314151821814	1	12,41	82
A6800DM-8	7314151821821	1	12,41	82
A6800DM-9	7314151821838	1	12,41	82
A6800DZ-1/2	7314151758899	1	15,00	83
A6800DZ-1/4	7314151758387	1	15,00	83
A6800DZ-11/32	7314151803872	1	15,00	83
A6800DZ-3/16	7314151758035	1	15,00	83
A6800DZ-3/8	7314151758622	1	15,00	83
A6800DZ-5/16	7314151758547	1	15,00	83
A6800DZ-7/16	7314151803889	1	15,00	83
A6800DZ-7/32	7314151758110	1	15,00	83
A6800DZ-9/16	7314151758974	1	15,00	83
A6800DZ-9/32	7314151758462	1	15,00	83
A6800SM-10	7314150360147	1	12,23	82
A6800SM-11	7314150360154	1	12,23	82
A6800SM-12	7314150360161	1	12,23	82
A6800SM-13	7314150360178	1	12,23	82
A6800SM-14	7314150360185	1	12,23	82
A6800SM-15	7314150360192	1	12,23	82
A6800SM-4	7314150360208	1	12,23	82
A6800SM-4.5	7314150360215	1	12,23	82
A6800SM-5	7314150360222	1	12,23	82
A6800SM-6	7314150360239	1	12,23	82
A6800SM-7	7314150360246	1	12,23	82
A6800SM-8	7314150360253	1	12,23	82
A6800SM-9	7314150360260	1	12,23	82
A6800SZ-1/8*	7314150360277	1	15,72	83
A6800SZ-5/32*	7314150360284	1	15,72	83
A7400DM-10	7314151819972	5	7,66	88
A7400DM-11	7314151819989	5	7,66	88
A7400DM-12	7314151819996	5	7,66	88
A7400DM-13	7314151820008	5	7,66	88
A7400DM-14	7314151820015	5	7,66	88
A7400DM-15	7314151820022	5	7,78	88
A7400DM-16	7314151820039	5	7,78	88
A7400DM-17	7314151820046	5	7,78	88
A7400DM-18	7314151820053	5	7,78	88
A7400DM-19	7314151820060	5	7,78	88
A7400DM-20	7314151820077	5	7,78	88
A7400DM-21	7314151820084	5	7,87	88
A7400DM-22	7314151820091	5	7,87	88
A7400DM-24	7314150386123	5	8,30	88
A7400DM-6	7314150118212	5	7,66	88
A7400DM-7	7314150118229	5	7,66	88
A7400DM-8	7314150118236	5	7,66	88
A7400DM-9	7314151819965	5	7,66	88
A7400DZ-1/2	7314151759780	5	8,49	89
A7400DZ-1/4	7314151759193	5	8,34	89
A7400DZ-11/16	7314151819897	5	8,61	89
A7400DZ-13/16	7314151819910	5	8,61	89
A7400DZ-17/32	7314151819866	5	8,49	89
A7400DZ-19/32	7314151819873	5	8,49	89

\* Hasta agotar existencias



A7400DZ-3/4	7314151819903	5	8,61	89
A7400DZ-3/8	7314151759438	5	8,34	89
A7400DZ-5/16	7314151759278	5	8,34	89
A7400DZ-5/8	7314151819880	5	8,61	89
A7400DZ-7/16	7314151759513	5	8,49	89
A7400DZ-7/8	7314151819927	5	8,61	89
A7400DZ-9/16	7314151759865	5	8,49	89
A7402DM-10	7314151820138	5	15,37	89
A7402DM-11	7314151820145	1	15,37	89
A7402DM-12	7314151820152	1	15,37	89
A7402DM-13	7314151820169	1	15,37	89
A7402DM-14	7314151820176	1	16,08	89
A7402DM-15	7314151820183	1	16,08	89
A7402DM-16	7314151820190	1	16,08	89
A7402DM-17	7314151820206	1	17,14	89
A7402DM-18	7314151820213	1	17,14	89
A7402DM-19	7314151820220	1	17,14	89
A7402DM-21	7314150385881	1	17,53	89
A7402DM-7	7314150220243	1	15,36	89
A7402DM-8	7314150220250	1	15,36	89
A7402DM-9	7314150220267	1	15,37	89
A7402DZ-1/2	7314151760526	1	17,26	90
A7402DZ-1/4	7314151759940	1	17,26	90
A7402DZ-11/16	7314151820114	1	17,26	90
A7402DZ-13/16	7314153003027	1	17,26	90
A7402DZ-19/32	7314153003041	1	17,26	90
A7402DZ-3/4	7314151820121	1	17,26	90
A7402DZ-3/8	7314151760366	1	17,26	90
A7402DZ-5/16	7314151760014	1	17,26	90
A7402DZ-5/8	7314151820107	1	17,26	90
A7402DZ-7/16	7314151760441	1	17,26	90
A7402DZ-7/8	7314153003034	1	17,26	90
A7402DZ-9/16	7314151760793	1	17,26	90
A7402SM-10	7314150541225	1	15,37	90
A7402SM-11	7314150541232	1	15,37	90
A7402SM-12	7314150542345	10	15,37	90
A7402SM-13	7314150542369	10	15,37	90
A7402SM-14	7314150542383	10	16,08	90
A7402SM-15	7314150542406	10	16,08	90
A7402SM-16	7314150542420	10	16,08	90
A7402SM-17	7314150542444	10	17,14	90
A7402SM-18	7314150542468	10	17,14	90
A7402SM-19	7314150542482	10	17,14	90
A7402SM-20	7314150542505	10	18,68	90
A7402SM-22	7314150542529	10	18,68	90
A7402SM-6	7314150542260	10	15,36	90
A7402SM-7	7314150542284	10	15,36	90
A7402SM-8	7314150542307	10	15,36	90
A7402SM-9	7314150542321	10	15,37	90
A7410DM-10	7314150543588	1	44,24	89
A7410DM-11	7314150543601	1	44,24	89
A7410DM-12	7314150543625	1	45,40	89
A7410DM-13	7314150543564	1	45,40	89
A7410DM-14	7314150543618	1	45,40	89
A7410DM-15	7314150543632	1	45,99	89
A7410DM-16	7314150543595	1	45,99	89
A7410DM-17	7314150543571	1	48,90	89
A7410DM-18	7314150543649	1	49,84	89
A7410DM-19	7314150543557	1	49,84	89
A7410DZ-1/2	7314153006301	1	42,02	89
A7410DZ-11/16	7314153006332	1	46,92	89
A7410DZ-3/4	7314153006349	1	46,92	89
A7410DZ-3/8	7314153006288	1	42,02	89
A7410DZ-5/16	7314153006271	1	40,59	89
A7410DZ-5/8	7314153006325	1	46,92	89
A7410DZ-7/16	7314153006295	1	42,02	89
A7410DZ-9/16	7314153006318	1	42,02	89
A7435DME*	7314153015006	1	340,32	72
A7535DZE*	7314153015013	1	409,49	73
ADJUST 3	7314150103515	1	79,91	41
ADJUST 3-90	7314150236336	1	93,84	40
ADJUST 9031/29	7314150302925	3	65,62	41
AP-234-F	7311518289027	2	95,57	614
AP-3M	7311518152062	1	62,04	613
AP-5M	7311518152079	1	81,94	613
APB260*	7314150389162	10	63,98	598
APB360*	7314150389186	10	64,65	598
AS-1200	7314150321520	3	67,92	533
AS-C33-JT-F	7314150341672	15	33,90	621
AS-C36-JT-M	7311518337490	15	36,32	621
AS-C39-JT-C	7314150341542	15	36,32	621
AS-C45-JT-C	7314150341559	15	42,36	621
ASP-1850	7311518337124	1	43,44	613
ASP-1850G	7311518337131	1	52,75	613
ASP-AS	7311518337377	6	18,76	613
ASP-AS-C33-JT-F	7314150341665	5	63,94	615
ASP-AS-C36-JT-M	7314150340590	5	66,68	616
ASP-AS-C39-JT-C	7314150341535	5	73,22	616
ASP-AS-C45-JT-C	7314150341566	2	75,84	616
ASP-AS-HOOK	7311518337582	4	40,95	614
ASP-ATP	7311518337384	6	28,54	613
ATP-110-210	7311518337575	1	78,19	613
ATP-200-350	7311518347062	1	99,49	613
ATP-200-500	7311518347055	1	115,89	613
ATP-230-410	7311518337599	2	111,20	614
AUTO	7314150438082	1	4.540,28	369







B141.007.075	7314150278404	5	8,49	212
B141.008.075	7314150278411	5	8,52	212
B141.009.075	7314150278428	5	8,56	212
B141.010.075	7314150278435	5	8,58	212
B141.015.100	7314150278442	5	8,65	212
B141.020.100	7314150278459	5	8,68	212
B141.025.125	7314150278466	5	9,03	212
B141.027.125	7314150278473	5	9,16	212
B141.030.150	7314150278480	5	10,44	212
B141.040.150	7314150278497	5	12,20	212
B142.000.075	7314150278718	10	6,99	484
B142.001.080	7314150278725	10	8,39	484
B142.001.150	7314150343188	10	9,86	484
B142.002.100	7314150278732	10	10,45	484
B142.002.175	7314150343195	10	12,17	484
B142.003.150	7314150278749	10	15,75	484
B143.020.100	7314150278510	5	4,09	212
B143.025.100	7314150278503	10	4,19	212
B143.030.100	7314150278527	10	4,25	212
B143.040.100	7314150278534	10	4,94	212
B143.050.100	7314150278541	10	6,02	212
B143.060.125	7314150278558	10	6,90	212
B143.080.150	7314150278565	5	9,89	212
B144.001.100	7314150278787	5	7,11	212
B144.002.125	7314150278794	5	7,61	212
B144.003.150	7314150278800	5	7,94	212
B145.006.100	7314150278756	5	6,78	213
B146.006.100	7314150278763	5	7,13	213
B147.001.400	7314150285594	1	29,14	365
B147.003.400	7314150285600	1	31,91	365
B148.001.080	7314150314522	10	8,39	484
B148.002.100	7314150314539	10	10,32	484
B149.001.080	7314150314546	10	8,71	484
B149.002.100	7314150314553	10	10,65	484
B150.010.100	7314150343126	10	6,48	484
B150.015.125	7314150343133	10	6,52	484
B150.020.125	7314150343140	10	6,65	484
B150.025.150	7314150343157	10	6,88	484
B190.040.075	7314150277810	10	4,86	210
B190.040.100	7314150277827	10	4,91	210
B190.055.100	7314150277834	10	6,22	210
B190.055.125	7314150277841	10	6,34	210
B190.065.125	7314150277858	10	7,80	210
B190.065.150	7314150277865	10	8,88	210
B190.080.150	7314150277872	10	9,75	210
B190.080.175	7314150277889	10	10,02	210
B190.100.200	7314150277896	10	13,15	210
B190.120.250	7314150277902	10	17,08	210
B190.140.250	7314150277919	10	18,19	210
B191.025.075	7314150277926	10	3,50	210
B191.030.075	7314150277933	10	3,61	210
B191.030.100	7314150277940	10	3,86	210
B191.030.200	7314150277957	10	6,20	210
B191.035.100	7314150277964	10	3,98	210
B191.040.100	7314150277971	10	4,55	210
B191.040.125	7314150277988	10	5,00	210
B191.040.250	7314150277995	10	7,47	210
B191.055.125	7314150278008	10	6,32	210
B191.055.150	7314150278015	10	7,08	210
B191.055.300	7314150278022	10	9,55	210
B191.065.150	7314150278039	10	8,34	210
B191.065.300	7314150278046	10	10,95	210
B192.000.075	7314150278084	10	4,80	211
B192.000.200	7314150278091	10	6,91	211
B192.001.100	7314150278107	10	5,89	211
B192.001.250	7314150278114	10	8,82	211
B192.002.125	7314150278121	10	7,33	211
B192.002.150	7314150442720	10	7,74	211
B192.002.300	7314150278138	10	11,10	211
B192.003.150	7314150278145	10	11,29	211
B192.004.200	7314150278169	10	15,63	211
B193.000.075	7314150278190	10	5,71	211
B193.001.100	7314150278206	10	6,40	211
B193.002.125	7314150278213	10	7,80	211
B193.003.150	7314150278220	10	11,89	211
B193.004.200	7314150278237	10	16,56	211
B194.004.075	7314150278268	10	6,78	212
B194.005.075	7314150278275	10	6,57	212
B194.006.075	7314150278282	10	6,11	212
B194.007.075	7314150278299	10	6,15	212
B194.008.075	7314150278305	10	6,17	212
B194.009.075	7314150278312	10	6,19	212
B194.010.075	7314150278329	10	6,20	212
B194.015.100	7314150278336	10	6,32	212
B194.020.100	7314150278343	10	6,40	212
B194.025.125	7314150278350	10	6,82	212
B194.027.125	7314150278367	10	6,99	212
B194.030.150	7314150278374	10	8,37	212
B194.040.150	7314150278381	10	10,09	212
B194.045.150	7314150278398	5	10,84	212
B195.001.025	7314150278176	10	6,11	211
B195.002.025	7314150278183	10	6,11	211
B195.006.050	7314150289493	5	6,11	213
B195.040.025	7314150278053	10	4,55	210
B195.050.025	7314150278060	10	5,85	210
B195.060.025	7314150278077	10	6,11	210



B195.901.025	7314150278244	10	6,45	211
B195.902.025	7314150278251	10	6,87	211
B196.025.075	7314150278589	10	6,18	483
B196.030.100	7314150278572	10	6,08	483
B196.035.100	7314150278596	10	6,32	483
B196.040.100	7314150278602	10	7,37	483
B196.055.125	7314150278619	10	8,79	483
B196.065.150	7314150278626	10	11,25	483
B196.080.175	7314150278633	10	12,41	483
B196.100.200	7314150278640	10	16,23	483
B196.120.200	7314150278657	10	18,82	483
B197.000.075	7314150278664	10	6,31	484
B197.001.080	7314150278671	10	7,80	484
B197.001.150	7314150343164	10	8,82	484
B197.002.100	7314150278688	10	10,07	484
B197.002.175	7314150343171	10	12,11	484
B197.003.150	7314150278695	10	12,90	484
B197.004.200	7314150278701	10	19,10	484
B198.040.125	7314150278817	5	9,85	213
B198.045.125	7314150278824	5	9,85	213
B198.050.150	7314150278831	5	10,36	213
B198.055.150	7314150281268	5	10,36	213
B198.060.150	7314150281763	5	10,84	213
B198.060.150F	7314150281770	5	15,80	214
B198.070.150	7314150281787	5	11,38	213
B198.070.150F	7314150281794	5	16,34	214
B198.080.150	7314150281800	5	13,70	213
B198.080.150F	7314150281817	5	17,45	214
B198.090.150	7314150281824	5	13,97	213
B198.100.150	7314150281831	5	14,37	213
B198.110.150	7314150281848	5	14,77	213
B198.120.150	7314150281855	5	16,68	213
B198.130.150	7314150281862	5	17,07	213
B198.140.150	7314150281879	5	18,70	213
B199.055.125	7314150281886	5	11,61	484
B199.060.125	7314150281893	5	12,66	484
B199.070.125	7314150281909	5	13,57	484
B199.080.125	7314150281916	5	14,99	484
B199.090.125	7314150281923	5	16,64	484
B199.100.125	7314150281930	5	18,41	484
B199.110.125	7314150281947	5	20,15	484
B199.120.125	7314150287741	5	22,47	484
B199.130.125	7314150287772	5	24,94	484
B219.002	7314150289301	1	10,35	206
B219.004	7314150283248	1	24,01	206
B219.005	7314150283255	1	28,02	207
B219.006	7314150283293	1	32,81	208
B219.007	7314150283323	1	43,87	208
B219.008	7314150283347	1	53,17	209
B219.010	7314150283354	1	55,85	210
B219.012	7314150327768	1	13,05	206
B219.014	7314150533985	1	28,33	206
B219.015	7314150283262	1	27,50	207
B219.016	7314150283309	1	33,51	208
B219.017	7314150283330	1	41,89	208
B219.025	7314150283279	1	31,31	207
B219.026	7314150283316	1	34,74	208
B219.027	7314150399833	1	45,35	209
B219.035	7314150283286	1	38,82	207
B219.045	7314150533992	1	33,11	207
B219.110	7314150392667	1	63,40	209
B219.210	7314150438969	1	62,05	209
B220.002	7314150289295	1	13,59	484
B220.005	7314150283361	1	35,00	485
B220.007	7314150283385	1	51,52	485
B220.012*	7314150314614	1	22,73	484
B220.015	7314150283378	1	36,10	485
B220.017	7314150283392	1	54,00	485
B220.027	7314150283408	1	47,71	485
B400.002	8412814119441	1	11,67	594
B400.003	8412814119458	1	11,67	594
B400.004	8412814119465	1	11,67	594
B400.005	8412814119472	1	11,67	594
B400.006	8412814119489	1	11,67	595
B400.007	8412814119496	1	11,67	595
B400.008	8412814119502	1	11,67	595
B400.009	8412814119519	1	11,67	595
B400.010	8412814119526	1	11,67	595
B400.011	8412814119533	1	14,69	595
B400.012	8412814119540	1	14,69	595
B400.013	8412814119557	1	14,69	595
B400.014	8412814119564	1	14,69	595
B400.015	8412814119571	1	14,69	595
B400.016	8412814119588	1	14,69	595
B400.017	8412814119595	1	14,69	595
B400.018	8412814119601	1	14,69	595
B400.019	8412814119618	1	14,69	595
B400.020	8412814119625	1	14,69	595
B400.021	8412814119632	1	19,47	595
B400.022	8412814119649	1	19,47	595
B400.023	8412814119656	1	19,47	595
B400.024	8412814119663	1	19,47	595
B400.025	8412814119670	1	19,47	595
B400.026	8412814119687	1	19,47	595
B400.027	8412814119694	1	19,47	595
B400.028	8412814119700	1	19,47	595

			€	
B400.029	8412814119717	1	19,47	595
B400.030	8412814119724	1	19,47	595
B400.031	8412814119731	1	25,14	595
B400.032	8412814119748	1	25,14	595
B400.033	8412814119755	1	25,14	595
B400.034	8412814119762	1	25,14	595
B400.035	8412814119779	1	25,14	595
B400.036	8412814119786	1	25,14	595
B400.037	8412814119793	1	25,14	595
B400.038	8412814119809	1	25,14	595
B400.039	8412814119816	1	25,14	595
B400.040	8412814119823	1	25,14	595
B400.041	8412814119830	1	29,57	595
B400.042	8412814119847	1	29,57	595
B400.043	8412814119854	1	29,57	595
B400.044	8412814119861	1	29,57	595
B400.045	8412814119878	1	29,57	595
B400.046	8412814119885	1	29,57	595
B400.047	8412814119892	1	29,57	595
B400.048	8412814119908	1	29,57	595
B400.049	8412814119915	1	29,57	595
B400.050	8412814119922	1	29,57	595
B705.1/4.125	7314150281978	5	12,36	223
BAC007	7314150242337	1	12,48	309
BASIC	7314150437436	1	1.507,98	369
BB10	7314150240586	1	12,55	333
BBA1224-3200	7314150341955	1	3.436,38	332
BBAGM12-1200	7314150535675	1	572,89	332
BBAGM1224-2400	7314150535682	1	1.299,60	332
BBAGMBAT	7314150537709	1	391,47	332
BBAGMCAB	7314150537723	1	20,69	332
BBAGMCHG	7314150537747	1	99,72	332
BBBCAB-AUZ	7314150183944	1	12,17	336
BBBCAB-EU	7314150186648	1	14,43	336
BBBCAB-UK	7314150183937	1	12,17	336
BBC420	7314150243235	1	601,20	333
BBC620	7314150243242	1	860,80	333
BBCE12-10	7314150330263	2	150,30	333
BBCE12-15S	7314150406722	2	182,62	333
BBCE12-3	7314150330249	2	102,49	332
BBCE12-6	7314150330256	2	122,97	332
BBCE12-F100	7314150344710	1	1.448,32	333
BBCE24-10	7314150330287	2	204,96	333
BBCEC1	7314150335459	1	10,11	335
BBCEC2	7314150337460	1	13,61	335
BB CER1	7314150335466	1	10,25	335
BB CER2	7314150337484	1	13,61	335
BBJL1630	7314150244898	5	42,36	332
BBJL2535	7314150209453	1	98,39	332
BBJL3545	7314150209460	1	130,90	332
BBR100	7314150345922	1	48,54	319
BBR110	7314150170562	1	104,02	320
BBR1501	7314150439119	24	17,81	323
BBR201P6	7314150205752	8	83,63	322
BBR201P64014	7314150237852	1	8,57	322
BBR201P64016	7314150237753	1	8,57	322
BBR201P64018	7314150237760	1	8,81	322
BBR201P67814	7314150237777	1	9,87	322
BBR201P67816	7314150237784	1	9,87	322
BBR201P67818	7314150237791	1	10,78	322
BBR202P4	7314150205769	1	47,13	322
BBR202P410	7314150207688	1	7,00	322
BBR202P414	7314150207695	1	7,00	322
BBR202P419	7314150207701	1	8,57	322
BBR202P455	7314150231393	1	8,57	322
BBR203P9	7314150208081	1	120,13	322
BBR203P920	7314150231102	1	15,93	322
BBR203P925	7314150231119	1	15,93	322
BBR203P927	7314150231126	1	15,93	322
BBR203P930	7314150231133	1	15,93	322
BBR203P940	7314150231140	1	15,93	322
BBR203P945	7314150231157	1	15,93	322
BBR203P950	7314150231164	1	15,93	322
BBR203P955	7314150231171	1	16,87	322
BBR203P960	7314150231188	1	16,87	322
BBR204	7314150430635	6	35,89	323
BBR210P3	7314150206056	1	159,67	322
BBR300P50	7314150269624	4	271,82	322
BBR320	7314150169887	1	103,32	321
BBR350	7314150169900	1	206,65	320
BBR400	7314150345939	1	38,83	321
BBR405	7314150435807	20	203,71	321
BBR410	7314150345946	24	52,68	321
BBR420	7314150403394	50	87,98	321
BBR501011	7314150438143	50	74,20	320
BBR50121314*	7314150438150	50	74,20	320
BBR6131	7314150239443	1	33,87	323
BBR6135	7314150239450	1	67,96	322
BBRAS14	7314150416943	4	299,93	320
BBRAS14-01	7314150418060	1	55,57	320
BBRAS14-02	7314150418077	1	26,78	320
BBRAS14-03	7314150418084	1	23,81	320
BBRAS14-04	7314150418091	1	35,69	320
BBRAS14-05	7314150418107	1	7,94	320
BBRAS14-06	7314150418114	1	8,93	320
BBRAS14-07	7314150418121	1	12,91	320

\* Hasta agotar existencias

			€	
BBRAS14-08	7314150418138	1	14,67	320
BBRAS14-09	7314150418145	1	15,25	320
BBRAS14-10	7314150418152	1	12,43	320
BBRAS14-11	7314150418169	1	67,91	320
BBRAS14-12	7314150418176	1	9,81	320
BBRAS14-13	7314150418183	1	22,25	320
BBRAS14-14	7314150418190	1	10,91	320
BBRBB12	7314150371297	1	1.766,26	320
BBRFKM1*	7314150384938	12	193,29	323
BBRPTG1	7314150412617	10	21,20	320
BBRS210P*	7314150206070	1	102,35	322
BBRS210P2	7314150206063	1	116,99	322
BBS075	7314150249824	12	41,74	339
BBS100	7314150169870	1	77,66	343
BBS10001	7314150207183	1	7,78	343
BBS10002	7314150207190	1	13,73	343
BBS10003	7314150207206	1	9,34	343
BBS10004	7314150207213	1	21,47	343
BBS10005	7314150207220	1	5,16	343
BBS100057	7314150186655	1	2,25	343
BBS10006	7314150207237	1	3,58	343
BBS10007	7314150207244	1	3,45	343
BBS10008	7314150207251	1	3,58	343
BBS10009	7314150207268	1	3,45	343
BBS10010	7314150207275	1	3,45	343
BBS101	7314150243525	1	31,90	340
BBS102	7314150243518	1	12,75	340
BBS103	7314150243488	1	20,81	339
BBS10450	7314150243501	1	28,85	340
BBS105	7314150250868	1	41,60	340
BBS106	7314150243495	1	20,32	339
BBS107	7314150250875	1	11,04	340
BBS108	7314150250882	1	11,04	340
BBS12SH	7314150243563	1	448,88	341
BBS150	7314150169849	1	133,14	339
BBS150R	7314150244959	1	51,31	340
BBS150S	7314150244973	1	59,64	340
BBS150T	7314150244966	1	65,19	340
BBS165	7314150205615	10	117,89	340
BBS165SP4	7314150205622	50	17,50	341
BBS170P13	7314150205608	1	219,12	340
BBS170P131	7314150231843	1	11,30	340
BBS170P132	7314150231850	1	11,30	340
BBS170P133	7314150231867	1	11,30	341
BBS170P134	7314150231874	1	11,30	341
BBS170P135	7314150231881	1	11,30	341
BBS170P136	7314150231898	1	11,30	341
BBS170P137	7314150231904	1	11,30	341
BBS170P138	7314150231911	1	13,10	341
BBS170P139	7314150231928	1	13,97	341
BBS200	7314150239498	1	44,38	343
BBS20P12	7314150169856	1	63,80	343
BBS210	7314150215362	1	411,91	343
BBS210U06	7314150217656	1	24,73	343
BBS210U08	7314150217663	1	26,93	343
BBS210UA06	7314150217670	1	29,96	343
BBS210UA08	7314150217687	1	32,98	343
BBS210V06	7314150217632	1	24,73	343
BBS210V08	7314150217649	1	26,93	343
BBS210W06	7314150218738	1	32,24	343
BBS210W08	7314150218745	1	35,21	343
BBS3BH1	7314150356843	1	117,89	339
BBS3BH1-VP	7314150355501	40	16,67	339
BBS3UH	7314150242351	1	476,43	339
BBS50	7314150169863	1	56,71	338
BBSDA	7314150247127	1	59,90	342
BBSDC	7314150247158	6	62,23	342
BBSDD	7314150247165	1	47,13	342
BBSDH	7314150247141	1	55,65	342
BBSDHR	7314150249299	1	24,85	342
BBSDT	7314150247134	6	67,70	342
BBSDW	7314150247110	6	46,59	342
BBSH1F	7314150247189	1	44,88	341
BBSH1M	7314150247196	1	63,04	341
BBSH2C	7314150247202	1	45,77	341
BBSH2CA	7314150247219	12	51,31	341
BBSH2CP	7314150247226	6	46,48	341
BBSH2F	7314150247172	6	45,77	341
BBSH3CF	7314150247240	6	46,82	341
BBSH3CF30	7314150247264	6	49,80	341
BBSH3FS	7314150247257	6	49,89	341
BBSH3MF	7314150247233	1	48,60	341
BBSHWH1	7314150328932	1	15,94	342
BBSS1	7314150247288	1	106,88	342
BBSS2	7314150247271	8	116,33	342
BBSS2L	7314150247295	1	121,68	342
BBT20	7314150166961	1	101,12	333
BBT60A	7314150504169	36	221,68	333
BBT80	7314150327805	6	627,17	333
BDACM1000	7314150500819	30	128,39	334
BE-3529	7314151847845	5	19,47	523
BE-6400M-4	7314153011145	5	12,58	200
BE-6400M-5	7314153011169	5	13,28	200
BE-6400M-5.5	7314153011176	5	13,28	200
BE-6400M-7	7314153011190	5	14,57	200
BE-6902	7314150242641	5	4,31	199





BE-6903	7314150242665	5	4,86	199
BE-6925	7314150242658	5	4,38	199
BE-6990-IP10	7314151846763	1	61,62	118
BE-6990-IP10-KL	7314151847531	10	7,74	119
BE-6990-IP15	7314151846770	1	61,62	118
BE-6990-IP15-KL	7314151847548	10	7,74	119
BE-6990-IP20-KL	7314151848668	10	6,23	119
BE-6990-IP6	7314151846725	1	61,62	118
BE-6990-IP6-KL	7314151847494	10	7,74	119
BE-6990-IP7	7314151846732	1	61,62	118
BE-6990-IP7-KL	7314151847500	10	7,74	119
BE-6990-IP8	7314151846749	1	61,62	118
BE-6990-IP8-KL	7314151847517	10	7,74	119
BE-6990-IP9	7314151846756	1	61,62	118
BE-6990-IP9-KL	7314151847524	10	7,74	119
BE-6990-IPSET	7314153019356	1	212,22	119
BE-6990TX-T10KL	7314151847760	10	7,68	119
BE-6990TX-T15KL	7314151847777	10	7,68	119
BE-6990TX-T20KL	7314151848682	10	7,68	119
BE-6990TX-T6-KL	7314151847722	10	7,68	119
BE-6990TX-T7-KL	7314151847739	10	7,68	119
BE-6990TX-T8-KL	7314151847746	10	7,68	119
BE-6990TX-T9-KL	7314151847753	10	7,68	119
BE-7515	7314150242528	5	8,49	198
BE-7520	7314150242535	5	8,68	198
BE-7525	7314150242542	5	9,18	198
BE-7527	7314150242559	5	9,97	198
BE-7530	7314150242566	5	10,70	198
BE-7540	7314150242573	5	11,88	198
BE-7606	7314151839017	5	20,62	201
BE-7607	7314151839024	5	20,91	201
BE-7608	7314151839031	5	22,32	201
BE-7675	7314150123896	1	64,28	234
BE-7715	7314150242580	5	10,61	198
BE-7720	7314150242597	5	10,68	198
BE-7725	7314150242603	5	11,02	198
BE-7727	7314150242610	5	11,15	198
BE-7730	7314150242627	5	11,57	198
BE-7740	7314150242634	5	11,83	198
BE-7803	7314151838867	5	12,58	200
BE-7804	7314151838881	5	12,58	200
BE-7805	7314151838904	5	13,28	200
BE-7806	7314151838928	5	13,89	200
BE-7806S	7314150242986	5	16,45	480
BE-7807	7314151838935	5	14,57	200
BE-7807S	7314150242993	5	17,63	480
BE-7808	7314151838942	5	17,54	200
BE-7808S	7314150243006	5	19,47	480
BE-7809	7314151838959	5	17,88	200
BE-7809S	7314150243013	5	21,65	480
BE-7810	7314151838966	5	18,40	200
BE-7810S	7314150243020	5	23,95	480
BE-7811	7314151838973	5	18,92	200
BE-7812	7314151838980	5	21,35	200
BE-7813	7314151838997	5	22,05	200
BE-7814	7314151839000	5	23,97	200
BE-7835	7314151838874	5	12,58	200
BE-7845	7314151838898	5	12,58	200
BE-7855	7314151838911	5	13,28	200
BE-7855S	7314150242979	5	14,98	480
BE-7907	7314153010964	5	10,87	198
BE-7908	7314153010971	5	10,91	198
BE-7909	7314153010988	5	10,94	198
BE-7910	7314151838799	5	10,98	198
BE-7915	7314151838805	5	11,05	198
BE-7920	7314151838812	5	11,11	198
BE-7925	7314151838829	5	11,57	198
BE-7927	7314151838836	5	11,74	198
BE-7930	7314151838843	5	13,37	198
BE-7940	7314151838850	5	15,63	198
BE-8002	7314150242825	5	4,03	196
BE-8010	7314150010615	5	4,16	196
BE-8010S	7314150033058	5	7,88	480
BE-8020	7314150010639	5	5,91	196
BE-8020I	7314150270316	5	6,89	516
BE-8020L	7314151838591	5	4,60	196
BE-8022	7314150242474	5	4,95	196
BE-8030	7314150010653	5	5,09	196
BE-8030I	7314150270330	5	7,43	516
BE-8040	7314150010677	5	5,82	196
BE-8040I	7314150270347	5	8,51	516
BE-8040S	7314150033089	5	9,56	480
BE-8040SL	7314150304578	10	10,52	482
BE-8050S	7314150033096	5	11,41	480
BE-8050SL	7314150304592	10	12,56	482
BE-8065S	7314150033119	5	16,12	480
BE-8080-1	7314153010995	5	15,66	199
BE-8080-10	7314153011060	5	22,28	199
BE-8080-2	7314153011008	5	16,13	199
BE-8080-3	7314153011015	5	16,13	199
BE-8080-4	7314153011022	5	16,13	199
BE-8080-5	7314153011039	5	16,13	199
BE-8080-6	7314153011046	5	16,13	199
BE-8080-8	7314153011053	5	22,28	199
BE-8135TB	7314150275052	10	8,78	205
BE-8145TB	7314150275076	10	11,56	205



BE-8150	7314150010707	5	7,97	196
BE-8150TB	7314150275113	10	13,37	205
BE-8155	7314150010721	5	10,00	196
BE-8155TB	7314150275090	10	15,71	205
BE-8158	7314153010858	5	12,92	196
BE-8159	7314153010865	5	15,19	196
BE-8160	7314150010745	5	14,82	196
BE-8210	7314151838584	5	4,47	196
BE-8220	7314150047741	5	6,72	196
BE-8220S	7314150048243	5	7,88	480
BE-8220SL	7314150304530	10	8,68	482
BE-8225	7314150242443	5	7,93	196
BE-8230	7314150047758	5	6,40	196
BE-8230S	7314150048250	5	8,22	480
BE-8230SL	7314150304554	10	9,04	482
BE-8235	7314150242450	5	8,17	196
BE-8240	7314150047765	5	9,56	196
BE-8241	7314150242467	5	8,10	196
BE-8241I	7314150270866	5	10,82	516
BE-8242	7314153010803	5	9,05	196
BE-8250	7314150047772	5	10,95	196
BE-8250L	7314151838607	5	12,24	196
BE-8251	7314150242461	5	9,89	196
BE-8252	7314153010810	5	10,68	196
BE-8252I	7314150270361	5	15,05	516
BE-8255	7314150047789	5	11,36	196
BE-8255S	7314150048281	5	14,60	480
BE-8255SL	7314150304615	5	16,07	482
BE-8256	7314153010827	5	12,48	196
BE-8256TB	7314150275137	10	20,80	205
BE-8257	7314153010834	5	12,82	196
BE-8258	7314153010841	5	16,85	196
BE-8258S	7314150242818	5	21,07	480
BE-8258TB	7314150275151	10	25,07	205
BE-8259S	7314150242832	5	24,49	480
BE-8260	7314150047796	5	17,22	196
BE-8262TB	7314150275526	10	30,11	205
BE-8330	7314151838614	5	5,45	196
BE-8340	7314151838621	5	5,82	196
BE-8350	7314151838638	5	7,47	196
BE-8355	7314151838652	5	7,81	197
BE-8360	7314151838676	5	8,96	197
BE-8450	7314151838645	5	8,06	197
BE-8455	7314151838669	5	9,34	197
BE-8510S	7314150126507	5	10,09	480
BE-8510SL	7314150304813	10	11,10	482
BE-8520S	7314150126514	5	13,75	480
BE-8520SL	7314150304837	10	15,13	482
BE-8571	7314150244652	1	65,50	203
BE-8572	7314150244669	1	69,46	203
BE-8573	7314150244676	1	67,50	204
BE-8574	7314150258666	1	68,07	204
BE-8575	7314150244638	1	20,52	201
BE-8576	7314150245741	1	134,38	204
BE-8577	7314151839048	5	15,80	201
BE-8600	7314150010769	5	6,15	197
BE-8600I	7314150270378	5	8,34	516
BE-8600S	7314150033126	5	8,21	480
BE-8601	7314151838706	5	8,08	197
BE-8602	7314151838713	5	8,08	197
BE-8605	7314150242498	5	6,31	197
BE-8608	7314150242504	5	8,86	197
BE-8610	7314150010776	5	7,55	197
BE-8610I	7314150270392	5	10,33	516
BE-8610L	7314151838683	5	11,30	197
BE-8610S	7314150033133	5	10,16	480
BE-8610SL	7314150304639	10	11,17	482
BE-8610TB	7314150275199	10	14,24	205
BE-8611	7311518292317	5	7,46	197
BE-8611S	7314150414703	5	10,14	480
BE-8612S	7314150242856	5	11,58	480
BE-8620	7314150010783	5	8,44	197
BE-8620I	7314150270408	5	14,49	516
BE-8620L	7314151838690	5	14,21	197
BE-8620S	7314150033140	5	13,08	480
BE-8620SL	7314150304653	10	14,41	482
BE-8620TB	7314150275212	10	15,81	205
BE-8621	7311518292324	5	8,28	197
BE-8621S	7314150242863	5	15,87	480
BE-8622	7314150242511	5	9,41	197
BE-8622S	7314150242870	5	15,91	480
BE-8623	7314153010872	5	14,45	197
BE-8623I	7314150270415	5	21,91	516
BE-8623TB	7314150275236	10	21,07	205
BE-8624	7314153010889	5	20,01	197
BE-8624TB	7314150275250	10	30,67	205
BE-8628	7314153010896	5	10,02	197
BE-8629	7314153010902	5	12,72	197
BE-8630	7314150010790	5	17,42	197
BE-8630S	7314150033157	5	16,78	480
BE-8640	7314150010806	5	23,20	197
BE-8640S	7314150033164	5	24,83	480
BE-8675	7314150123872	1	77,34	233
BE-8700-1/4	7314150242689	5	10,36	199
BE-8700-3/16	7314150242696	5	8,22	199
BE-8700-3/8	7314150242702	5	18,70	199





BE-8700-5/16	7314150242719	5	14,63	199
BE-8700-5/32	7314150242726	5	6,42	199
BE-8700-7/32	7314150242733	5	8,84	199
BE-8700-7/64	7314150275878	5	9,14	199
BE-8702	7314151838768	5	5,26	199
BE-8703	7314150027651	5	5,45	199
BE-8703S	7314151839130	5	6,77	480
BE-8704	7314150027668	5	6,20	199
BE-8704S	7314151839147	5	8,23	480
BE-8705	7314150027675	5	7,69	199
BE-8705S	7314151839154	5	9,31	480
BE-8706	7314150027682	5	8,84	199
BE-8706S	7314151839161	5	9,80	480
BE-8708	7314150027699	5	12,65	199
BE-8708S	7314151839178	5	13,18	480
BE-8710	7314150027705	5	14,28	199
BE-8710S	7314150126521	5	10,99	480
BE-8710SL	7314150304851	10	12,09	482
BE-8715	7314150242672	5	5,08	199
BE-8720S	7314150126538	5	14,86	480
BE-8720SL	7314150304875	10	16,36	482
BE-8725	7314151838775	5	5,38	199
BE-8725S	7314151839123	5	6,49	480
BE-8800	7314150042012	5	7,33	197
BE-8800I	7314150270422	5	10,30	516
BE-8800S	7314151839055	5	9,12	480
BE-8801	7314151838744	5	8,27	198
BE-8802	7314151838751	5	8,27	198
BE-8810	7314150010813	5	8,20	197
BE-8810I	7314150270439	5	11,94	516
BE-8810L	7314151838720	5	9,54	197
BE-8810S	7314150048298	5	10,90	480
BE-8810SL	7314150304677	10	12,00	482
BE-8810TB	7314150275274	10	12,77	205
BE-8811	7311518292331	5	7,46	197
BE-8811S	7314150414710	5	10,90	480
BE-8812S	7314150242894	5	12,91	480
BE-8820	7314150010820	5	10,00	197
BE-8820I	7314150270446	5	15,75	516
BE-8820L	7314151838737	5	20,35	197
BE-8820S	7314150048304	5	13,60	480
BE-8820SL	7314150304691	10	14,95	482
BE-8820TB	7314150275298	10	18,09	205
BE-8821	7311518292348	5	16,86	197
BE-8821S	7314150242900	5	14,10	480
BE-8822S	7314150242917	5	15,97	480
BE-8823	7314153010919	5	15,21	197
BE-8823I	7314150270453	5	23,02	516
BE-8823TB	7314150275311	10	23,68	205
BE-8824	7314153010926	5	21,22	197
BE-8824TB	7314150275335	10	33,01	205
BE-8828	7314153010933	5	12,29	197
BE-8829	7314153010940	5	15,80	197
BE-8830	7314150010837	5	15,25	197
BE-8830S	7314150048311	5	20,47	480
BE-8840	7314150010844	5	19,96	197
BE-8840S	7314151839062	5	23,49	480
BE-8865	7314150010851	5	17,60	196
BE-8870	7314150010875	5	18,95	196
BE-8880	7314150010899	5	24,19	196
BE-8890	7314150010905	5	30,59	196
BE-8904	7314153010957	5	7,74	198
BE-8905	7314153010049	5	7,74	198
BE-8905S	7314150242924	5	8,24	480
BE-8906	7314150027729	5	7,81	198
BE-8906S	7314150242931	5	8,24	480
BE-8907	7314150027736	5	7,86	198
BE-8907S	7314150242948	5	8,24	480
BE-8908	7314150027743	5	7,89	198
BE-8908S	7314150242955	5	8,24	480
BE-8909	7314150027750	5	7,92	198
BE-8909S	7314150242962	5	8,24	480
BE-8910	7314150027767	5	7,93	198
BE-8910I	7314150270460	5	10,08	516
BE-8910S	7314151839079	5	8,51	480
BE-8910SL	7314150304714	5	9,35	482
BE-8910TB	7314150275359	5	8,27	206
BE-8915	7314150027774	5	8,10	198
BE-8915I	7314150270477	5	10,17	516
BE-8915S	7314151839086	5	8,57	480
BE-8915SL	7314150304738	5	9,43	482
BE-8915TB	7314150275373	5	11,22	206
BE-8920	7314150027781	5	8,20	198
BE-8920I	7314150270484	5	10,30	516
BE-8920S	7314151839093	5	8,72	480
BE-8920SL	7314150304752	5	9,60	482
BE-8920TB	7314150275397	5	11,41	206
BE-8925	7314150027798	5	8,74	198
BE-8925I	7314150270491	5	10,99	516
BE-8925S	7314151839109	5	9,04	480
BE-8925SL	7314150304776	5	9,95	482
BE-8925TB	7314150275410	5	12,13	206
BE-8927	7314150027804	5	8,97	198
BE-8927TB	7314150275434	5	13,27	206
BE-8930	7314150027811	5	10,72	198
BE-8930S	7314151839116	5	11,68	480

\* Hasta agotar existencias



BE-8930SL	7314150304790	5	12,86	482
BE-8930TB	7314150275458	5	13,94	206
BE-8940	7314150027828	5	12,93	198
BE-8940TB	7314150275472	5	15,74	206
BE-8945	7314151838782	5	13,89	198
BE-8975	7314150056576	6	43,06	233
BE-8975B	7314150188741	6	43,06	233
BE-8976B	7314150216369	6	48,91	234
BE-8980	7314153010681	5	9,14	200
BE-8985	7314153010698	5	8,68	200
BE-8986	7314150267026	5	9,03	200
BE-9001	7311518269005	5	9,08	199
BE-9002	7311518269012	5	9,76	199
BE-9003	7311518269029	5	10,17	199
BE-9100	7314150242757	5	9,63	199
BE-9101	7314150242764	5	9,63	199
BE-9102	7314150242771	5	9,63	199
BE-9103	7314150242788	5	9,63	199
BE-9104	7314150242795	5	11,05	199
BE-9105	7314150242801	5	11,05	199
BE-9575	7314150123841	1	47,44	232
BE-9578	7314150123803	1	13,43	229
BE-9585	7314150123858	1	50,32	233
BE-9586	7314150216000	1	10,36	230
BE-9588	7314150123810	1	21,29	230
BE-9675	7314150123889	1	69,03	233
BE-9676	7314150216017	1	17,95	231
BE-9678	7314150123827	1	33,25	231
BE-9688	7314150123834	1	35,50	231
BE-9765	7314150055128	3	11,07	231
BE-9770	7314150027712	3	18,25	231
BE-9770I	7314150276332	20	34,69	517
BE-9775	7314150056330	3	16,37	231
BE-9776	7314150056545	6	18,60	230
BE-9776B	7314150216352	6	35,97	231
BE-9777	7314150056552	6	25,22	230
BE-9777B	7314150188734	6	24,19	230
BE-9780	7314150033386	3	30,17	232
BE-9785	7314150056347	3	27,94	232
BE-9786I	7314150314485	1	43,12	517
BE-9787	7314150056569	6	26,69	230
BE-9871	7314150234707	1	46,36	195
BE-9871SL	7314150470792	1	55,23	483
BE-9872	7314150440412	1	77,00	195
BE-9872SL	7314150470785	1	56,41	483
BE-9875	7314150314447	1	103,26	195
BE-9876S	7314150315000	1	117,15	482
BE-9877	7314150320745	1	111,91	196
BE-9878	7314150186259	1	14,87	228
BE-9878SL	7314150321018	1	111,13	483
BE-9879	7314150383474	1	83,41	195
BE-9880	7314150238569	3	39,52	228
BE-9880SL	7314150337651	1	44,14	483
BE-9881	7314150043279	1	43,68	194
BE-9881I	7314150270507	1	58,92	516
BE-9881S	7314151839307	1	45,51	481
BE-9881SL	7314150304899	1	50,05	483
BE-9881TB	7314150275502	1	58,40	204
BE-9882	7314151839284	1	45,45	194
BE-9882I	7314150270514	1	61,48	516
BE-9882S	7314151839314	1	46,95	481
BE-9882SL	7314150304912	1	51,64	483
BE-9882TB	7314150275496	1	61,17	205
BE-9884	7314150243068	1	47,37	194
BE-9884S	7314150236602	1	66,71	481
BE-9885	7314150048465	1	41,72	194
BE-9885S	7314150126491	1	48,47	481
BE-9885TB	7314150275519	1	53,80	205
BE-9886	7314150048472	1	46,29	194
BE-9887S	7314150244744	1	62,03	481
BE-9888S	7314153006158	1	66,95	481
BE-9889S	7314150244751	1	57,03	481
BE-9890S	7314150237715	1	24,85	481
BE-9890SL	7314150315086	1	27,36	482
BE-9891SL	7314150321506	1	24,59	482
BE-9894SL	7314150321490	1	25,91	483
BE1100	7314150205929	8	334,55	305
BE110001	7314150230228	1	62,76	305
BE110014	7314150230204	1	21,55	304
BE110015	7314150230211	1	105,35	304
BE1100AC1	7314150230266	1	70,16	304
BE1100AC2	7314150333394	1	21,85	304
BE1200P6	7314150205516	1	157,30	302
BE1200P6AC1	7314150205523	1	111,82	302
BE1205	7314150205554	1	83,21	302
BE1210P11	7314150209101	1	162,27	303
BE1210P1101	7314150269822	1	12,96	302
BE1210P1102	7314150269839	1	13,98	302
BE1210P1103	7314150269846	1	13,98	302
BE1210P9AC1	7314150205547	1	110,98	303
BE1300	7314150205578	1	98,47	301
BE1300SH	7314150205585	10	51,31	301
BE1305P450*	7314150206032	1	343,93	301
BE1305P450WS01	7314150269228	1	25,29	301
BE1305P450WS02	7314150269235	1	13,64	301
BE1305P450WS03	7314150269242	1	21,55	301





# BE1305P450WS04



BE1305P450WS04	7314150269327	1	25,80	301
BE1305P450WS05	7314150269334	1	29,49	301
BE1305P450WS06	7314150269341	1	33,73	301
BE1305P450WS07	7314150269358	1	20,94	301
BE1305P450WS08	7314150269365	1	22,18	301
BE1305P450WS09	7314150269372	1	27,04	301
BE1305P450WS10	7314150269310	1	29,49	301
BE1305P450WS11	7314150269389	1	30,03	301
BE1305P450WS12	7314150269396	1	17,93	301
BE1305P450WS13	7314150269402	1	13,64	301
BE1305P450WS14	7314150269419	1	13,64	301
BE1305P450WS15	7314150269426	1	30,03	301
BE1310P4*	7314150205707	1	117,89	300
BE1310P425	7314150233649	1	28,31	300
BE1310P427	7314150233656	1	30,99	300
BE1310P429	7314150233663	1	33,44	300
BE1310P430	7314150233670	1	33,44	300
BE1311P13	7314150235414	1	435,47	300
BE1312DNS*	7314150450596	12	11,78	301
BE1315P7	7314150205776	1	124,67	301
BE1315P71	7314150230273	1	24,15	301
BE1315P72	7314150230280	1	20,26	301
BE1315P73	7314150230297	1	25,09	301
BE1315P74	7314150230303	1	24,52	301
BE1315P75	7314150230310	1	24,52	301
BE1315P76	7314150230327	1	25,09	301
BE1315P77	7314150230334	1	27,69	301
BE1320S17	7314150415366	10	122,19	300
BE13ZL11	7314150239733	1	624,08	302
BE1FFWF	7314150403325	12	24,27	311
BE1FLD1	7314150250745	1	16,79	311
BE1FLD2	7314150250752	1	16,79	311
BE1FLD3	7314150250769	1	16,79	311
BE1FLDS	7314150250783	1	45,77	311
BE1FTW	7314150251209	1	69,90	311
BE1GP5	7314150170043	1	66,96	302
BE1GP5-T	7314150170050	10	30,05	303
BE1GP510	7314150207732	1	23,20	303
BE1GP512	7314150207749	1	23,20	303
BE1GP514	7314150207756	1	23,20	303
BE1GP58	7314150207718	1	23,20	303
BE1GP59	7314150207725	1	23,20	303
BE1P	7314150170067	1	78,33	303
BE1SP14L	7314150170074	1	27,60	303
BE1SP16L	7314150492756	10	27,60	303
BE1SP1F*	7314150435777	12	29,38	303
BE1T14	7314150167630	1	35,78	304
BE1T16	7314150167647	1	40,91	304
BE1T21	7314150167654	1	40,31	304
BE1TH-10	7314150343980	5	30,85	312
BE1TH-2	7314150343874	10	17,75	312
BE1TH-2.5	7314150343881	10	17,75	312
BE1TH-3	7314150343898	10	18,23	312
BE1TH-3.5*	7314150343904	10	18,23	312
BE1TH-4	7314150343911	10	20,73	312
BE1TH-4.5*	7314150343928	10	21,49	312
BE1TH-5	7314150343935	10	22,19	312
BE1TH-6	7314150343942	10	24,56	312
BE1TH-7*	7314150343959	10	28,24	312
BE1TH-8	7314150343966	10	28,24	312
BE1TH-9*	7314150343973	10	30,85	312
BE1TH-S5	7314150457502	1	91,42	312
BE1TH-S6	7314150344017	30	102,63	312
BE1TS-10	7314150344062	10	30,51	312
BE1TS-11*	7314150344079	10	30,78	312
BE1TS-12	7314150344086	10	31,61	312
BE1TS-13	7314150344093	10	32,31	312
BE1TS-14	7314150344109	10	32,31	312
BE1TS-15*	7314150344116	10	35,02	312
BE1TS-16*	7314150344123	10	35,02	312
BE1TS-17	7314150344130	10	35,02	312
BE1TS-18*	7314150344147	10	38,27	312
BE1TS-19*	7314150344154	10	38,27	312
BE1TS-20*	7314150344161	8	45,22	312
BE1TS-21*	7314150344178	8	25,30	312
BE1TS-22*	7314150344185	8	45,35	312
BE1TS-24*	7314150344192	8	41,47	312
BE1TS-6	7314150344024	10	26,64	312
BE1TS-7	7314150344031	10	26,64	312
BE1TS-8	7314150344048	10	29,27	312
BE1TS-9*	7314150344055	10	30,51	312
BE1TS-S7	7314150344208	1	193,58	312
BE200CAB250SH10*	7314150165452	1	2.602,79	354
BE200CAB250SH25	7314150165469	1	3.602,63	354
BE200CAB250SH3*	7314150165445	1	1.735,22	354
BE200CAB40F1*	7314150165391	1	1.132,01	354
BE200CAB55F1*	7314150165407	1	793,23	354
BE200CAB55F3*	7314150165414	1	1.049,39	354
BE200CAB58SR1	7314150165421	1	809,78	354
BE200CAB58SR3	7314150165438	1	1.074,19	354
BE200CAB80SR1	7314150165384	1	422,82	354
BE200CAB80SR3	7314150165476	1	811,69	354
BE200MAG55	7314150165513	1	77,66	354
BE200MIR4035	7314150245161	1	69,14	354
BE200MIR4055	7314150245185	1	69,14	354
BE200MIR5535	7314150165483	1	77,67	354



BE200MIR5545	7314150165490	1	77,67	354
BE200MIR5555	7314150165506	1	77,67	354
BE200MIR8035	7314150165520	1	76,32	354
BE200MIR8045	7314150165537	1	76,32	354
BE200MIR8055	7314150165544	1	76,32	354
BE220	7314150170005	1	249,63	354
BE230	7314150182633	1	184,37	299
BE239	7314150243143	1	97,08	299
BE240	7314150239917	1	1.022,52	299
BE240-CAT	7314150289417	1	110,95	299
BE250	7314150169924	1	48,54	309
BE251200	7314150249343	1	102,63	328
BE2512005	7314150249350	1	80,44	328
BE2512008	7314150249367	1	85,98	329
BE251A	7314150540136	12	48,54	310
BE253	7314150250806	1	123,44	310
BE2541	7314150251797	1	17,08	310
BE2542	7314150251803	1	6,52	310
BE254A	7314150446070	1	116,32	310
BE254A-01	7314150453405	1	42,28	310
BE256-155	7314150205875	1	9,71	311
BE256-178	7314150205882	1	12,48	311
BE256-250	7314150205899	1	16,63	311
BE256M	7314150205851	1	47,13	310
BE256P3	7314150205868	1	34,68	311
BE257	7314150205844	8	106,46	300
BE25710	7314150230549	1	17,62	300
BE25718	7314150230532	1	17,62	300
BE2572	7314150230556	1	12,49	300
BE2576	7314150230525	1	15,49	300
BE258	7314150251780	1	128,36	310
BE301	7314150430871	2	470,47	330
BE301CM	7314150430888	50	64,68	330
BE301CM-01	7314150430956	20	33,32	330
BE301CM-02	7314150430963	20	33,32	330
BE310	7314150205943	8	83,21	330
BE400P24	7314150205806	1	436,85	305
BE400P2401	7314150230600	1	28,74	306
BE400P2402	7314150230617	1	28,74	306
BE400P2403	7314150230624	1	25,42	306
BE400P2404	7314150230631	1	16,56	306
BE400P2405	7314150230648	1	16,56	306
BE400P2406	7314150230655	1	16,56	307
BE400P2407	7314150230662	1	16,56	307
BE400P2408	7314150230679	1	16,56	307
BE400P2409	7314150230686	1	16,56	307
BE400P241	7314150230563	1	117,38	306
BE400P2410	7314150230693	1	16,56	307
BE400P2411	7314150230709	1	16,56	307
BE400P2412	7314150230716	1	16,56	307
BE400P2413	7314150230723	1	16,56	307
BE400P2414	7314150230730	1	17,50	307
BE400P2415	7314150230747	1	17,81	308
BE400P2416	7314150230754	1	17,50	308
BE400P2417	7314150230761	1	17,50	308
BE400P2418	7314150230778	1	17,50	308
BE400P2419	7314150230785	1	17,50	308
BE400P242	7314150230570	1	11,94	306
BE400P2420	7314150237647	1	44,18	308
BE400P243	7314150230587	1	11,94	306
BE400P244	7314150230594	1	23,11	306
BE401	7314150240593	1	11,01	305
BE410	7314150205813	4	271,82	308
BE4101	7314150230792	1	11,93	308
BE5008*	7314150239344	1	105,28	302
BE5008-10*	7314150239269	1	16,22	302
BE5008-15*	7314150239276	1	16,22	302
BE5008-20*	7314150239283	1	16,22	302
BE5008-25*	7314150239290	1	16,22	302
BE5008-27*	7314150239306	1	16,22	302
BE5008-30*	7314150239313	1	16,22	302
BE5008-40*	7314150239320	1	16,22	302
BE5008-45*	7314150239337	1	16,22	302
BE500P24	7314150169955	5	152,55	299
BE500P2401	7314150209569	1	11,91	299
BE500P2402	7314150209682	1	11,60	299
BE500P2403	7314150209736	1	12,90	299
BE500P2404	7314150209729	1	13,06	299
BE500P2405	7314150209613	1	13,92	299
BE500P2406	7314150209804	1	17,96	299
BE500P2407	7314150209781	1	17,96	299
BE500P2408	7314150209743	1	6,73	299
BE500P2409	7314150209750	1	6,66	299
BE500P2410	7314150209637	1	6,66	299
BE500P2411	7314150209644	1	6,66	299
BE500P2412	7314150209699	1	6,66	299
BE500P2413	7314150209705	1	6,66	299
BE500P2414	7314150209798	1	18,13	299
BE500P2415	7314150209675	1	12,32	299
BE500P2416	7314150209620	1	11,65	299
BE500P2417	7314150209583	1	11,45	299
BE500P2418	7314150209576	1	11,91	299
BE500P2419	7314150209767	1	11,45	299
BE500P2420	7314150209590	1	11,91	299
BE500P2421	7314150209606	1	11,91	299
BE500P2422	7314150209774	1	17,96	299





BE621713	7314150232765	1	6,61	317
BE621714	7314150232772	1	6,61	317
BE621715	7314150232789	1	6,61	317
BE621716	7314150232796	1	14,51	317
BE621717	7314150232802	1	14,51	317
BE630	7314150169580	3	191,38	316
BE63010015F	7314150232598	25	13,86	316
BE63010615F	7314150232604	1	13,86	316
BE63010815F	7314150232611	1	13,86	316
BE63010818F	7314150232628	1	13,86	316
BE630246F	7314150169597	50	26,78	316
BE6302712F	7314150412846	5	23,33	316
BE630276F	7314150169603	50	26,78	316
BE630326F	7314150169610	50	26,78	316
BE630366F	7314150169627	100	26,78	316
BE630386F	7314150169634	50	26,78	316
BE63064514F1	7314150340095	1	24,27	316
BE63064514F2	7314150340101	1	24,82	317
BE6306514F	7314150232123	12	13,86	316
BE630656714F	7314150232130	12	13,86	316
BE63066514F	7314150169641	25	26,78	316
BE630666F	7314150232116	1	13,86	316
BE6306814F	7314150232154	1	13,86	316
BE6307314F	7314150232161	1	13,86	316
BE6307414F	7314150370108	10	19,99	317
BE6307415F	7314150232178	1	13,86	316
BE630747615F	7314150232307	12	13,86	316
BE630757715F	7314150232321	1	13,86	316
BE6307612F	7314150232345	12	13,86	316
BE6307614F	7314150232369	12	13,86	316
BE6307630F	7314150232437	1	13,86	316
BE630768F	7314150232468	1	13,86	316
BE6307815F	7314150232475	12	13,86	316
BE6308015F	7314150232482	1	13,86	316
BE630808215F	7314150232499	1	13,86	316
BE6308414F	7314150543205	12	17,00	316
BE6308616F	7314150232505	1	13,86	316
BE6308618F	7314150232512	1	13,86	316
BE6309015F	7314150232529	12	13,86	316
BE6309210F	7314150232536	1	13,86	316
BE6309315F	7314150232543	1	13,86	316
BE6309336F	7314150232550	1	13,86	316
BE6309345F	7314150232567	1	13,86	316
BE6309515F	7314150232574	1	13,86	316
BE6309618F	7314150232581	1	13,86	316
BE64350	7314150169672	1	54,78	315
BE64350CH	7314150169696	1	40,91	315
BE64520	7314150169665	1	65,19	315
BE64520CH	7314150169689	1	51,52	315
BE65F65120	7314150169658	12	15,26	315
BE65R106160	7314150170036	1	135,91	316
BE65R65120	7314150170012	1	30,51	316
BE65R80120	7314150170029	1	116,49	316
BE66152A	7314150492534	6	22,42	315
BE6701VAG	7314150333875	1	24,97	317
BE68	7314150237876	1	6,78	317
BE6810	7314150237869	1	13,73	317
BE6810Z	7314150430765	12	32,34	317
BE6FCP	7314150438907	30	45,74	311
BE6OF108	7314150434572	50	34,80	315
BE6OFW	7314150435784	5	62,78	315
BE700*	7314150206087	1	88,13	308
BE700BP2	7314150206100	1	81,23	308
BE700SP15	7314150206094	1	38,31	308
BE74-55100	7314150169733	1	48,60	305
BE74-57125	7314150169511	1	50,04	305
BE74-57125L	7314150169535	1	54,48	305
BE74-80120	7314150169740	1	51,52	305
BE74-90175	7314150169528	1	75,05	305
BE76101	7314150240005	1	64,36	301
BE762	7314150384983	12	13,27	301
BE800P12	7314150205677	1	74,90	309
BELMS120BDL	7314150340323	8	74,51	331
BELP1224	7314150177882	1	90,16	335
BELS12	7314150170579	1	95,70	335
BELT1213A	7314150493104	1	319,03	334
BELT127*	7314150177899	1	109,56	334
BELT2415A	7314150493098	20	371,57	334
BELT247N	7314150170586	1	119,27	334
BELT247S	7314150170593	1	119,27	334
BELTKEY*	7314150177875	1	183,06	334
BELTRP16	7314150169917	1	221,89	335
BELTRP1601	7314150231935	1	23,33	335
BELTRP1602	7314150231942	1	2,21	335
BELTRP1603	7314150231959	1	24,51	335
BELTRP1604	7314150231966	1	2,21	335
BELTRP1605	7314150231973	1	23,33	335
BELTRP1606	7314150231980	1	2,21	335
BELTRP1607	7314150231997	1	21,88	335
BELTRP1608	7314150232000	1	23,33	335
BELTRP1609	7314150232017	1	18,48	335
BELTRP1610	7314150232024	1	20,47	335
BELTRP1611	7314150232031	1	22,76	335
BELTRP1612	7314150232048	1	23,80	335
BELTRP1613	7314150232062	1	15,60	335
BELTRP1614	7314150232079	1	18,46	335



BELTRP1615	7314150232086	1	18,46	335
BELTRP1616	7314150232093	1	18,46	335
BFLR11	7314150306534	1	62,60	352
BGIS125	7314150416431	20	171,96	335
BH110000A-02	7314150273669	1	108,13	346
BH110000A-04	7314150273683	1	12,60	346
BH110000A-EXT*	7314150291946	1	142,89	346
BH110000B	7314150516414	1	1.628,48	346
BH11500	7314150178797	1	596,84	345
BH11500-01	7314150182220	1	25,95	350
BH11500-02	7314150182237	1	18,26	346
BH11500-04	7314150182275	1	6,83	346
BH12000	7314150178803	1	530,53	345
BH13000	7314150178810	1	408,51	345
BH13000-02	7314150182244	1	23,25	346
BH13000L	7314150301980	1	1.286,52	346
BH13000L-01	7314150301997	1	17,41	350
BH13000QA	7314150403295	1	600,45	345
BH15000A-01	7314150273515	1	28,00	350
BH15000A-02	7314150273522	1	59,55	346
BH15000A-04	7314150273546	1	4,76	346
BH15000B	7314150516407	1	1.087,42	346
BH1A1500-04	7314150265299	1	34,58	350
BH1A1500A	7314150460946	1	379,85	345
BH1A2500-03	7314150226856	1	80,18	346
BH1A2500-04	7314150226863	1	61,10	350
BH1A2500A	7314150460953	1	582,03	345
BH1CB1000	7314150243204	1	184,38	346
BH1CD680	7314150330379	1	204,25	349
BH1CD680ST	7314150330386	1	100,26	349
BH1EU3000	7314150245000	1	262,60	345
BH1EU3000-01	7314150250004	1	14,05	346
BH1EU3000-03	7314150249893	1	7,01	346
BH1EU3000-08	7314150249947	1	24,86	350
BH1S45	7314150292295	1	745,00	346
BH1S45-01	7314150311194	1	23,66	350
BH1S45-03	7314150311217	1	11,23	346
BH230	7314150264070	1	3.448,43	347
BH23015	7314150178759	1	2.765,81	347
BH23015C	7314150178742	1	1.724,21	347
BH2402010	7314150178766	1	2.374,11	347
BH2604020	7314150178773	1	3.249,47	347
BH28050	7314150472222	1	3.855,64	348
BH2AC60V110*	7314150178933	1	420,80	348
BH33000	7314150178674	1	66,84	348
BH36000	7314150178681	1	131,45	348
BH3A10000	7314150234660	1	298,02	348
BH3A3000	7314150234646	1	111,39	348
BH3A5000	7314150234653	1	167,10	348
BH3AL2500*	7314150302420	1	156,51	348
BH3HD12000	7314150170500	1	145,00	348
BH3HD16000	7314150170524	1	155,00	348
BH3HD20000A	7314150337668	1	270,00	349
BH3HD8000	7314150170494	2	75,00	348
BH3SQ15000	7314150234684	2	185,00	348
BH3SQ7000	7314150234677	2	92,00	348
BH4B12	7314150557806	2	150,00	344
BH4B2	7314150557820	10	67,00	344
BH4B20	7314150557844	2	167,80	344
BH4B30	7314150557783	1	220,00	344
BH4B5	7314150557868	6	80,00	344
BH4B8	7314150557882	4	122,00	344
BH4G12	7314150557905	4	75,00	344
BH4G2	7314150557929	6	31,00	344
BH4G20	7314150557943	2	105,00	344
BH4G4	7314150557967	6	40,00	344
BH4G50	7314150557981	1	260,00	344
BH4G6	7314150558001	4	50,00	344
BH4G8	7314150558025	4	59,00	344
BH4HP50	7314150477081	1	735,20	345
BH5DP1000QA	7314150270224	1	953,63	349
BH5SP500QA	7314150270217	1	514,08	349
BH5US1000	7314150243174	1	243,51	349
BH6AC1-680A	7314150433544	1	120,30	350
BH6FC1000	7314150178650	1	857,74	350
BH6FC2000	7314150234639	1	1.379,37	350
BH6PC600	7314150234622	1	1.034,52	349
BH7100A	7314150345908	1	7.944,64	336
BH7100SG	7314150299782	1	464,20	337
BH715	7314150237555	1	1.058,25	336
BH715-13	7314150239191	1	152,54	336
BH720	7314150235650	1	1.941,74	336
BH720-22	7314150236961	1	166,39	336
BH720SG	7314150238477	1	154,82	336
BH730	7314150235667	1	2.273,30	336
BH730SG	7314150238484	1	168,91	336
BH750	7314150235674	1	3.339,65	336
BH750SG	7314150238491	1	182,98	336
BH7PS30	7314150474882	2	323,05	336
BH8AC1-500	7314150170463	1	164,91	309
BH8AC2-500	7314150412532	1	486,41	309
BH8AC3-1500A	7314150516391	1	1.936,14	349
BH8AC3-600	7314150351893	1	1.002,55	349
BH8BC1	7314150242276	1	118,55	344
BH8BC2	7314150242283	1	141,69	344
BH8BC3	7314150242290	10	112,02	344



			€	
BH8BC4	7314150242306	6	240,83	344
BH8BC5	7314150242313	6	166,37	344
BH8PR10000	7314150178957	1	409,13	344
BH8PR4000	7314150178940	1	272,86	344
BH9BJ22SLH	7314150246946	1	775,85	347
BH9BJ22SSH	7314150247462	1	755,99	346
BH9BJ23SLH	7314150246953	1	1.041,86	347
BH9BJ23SSH	7314150246960	1	1.021,97	347
BH9BJ260	7314150247509	1	36,92	347
BH9BJ280	7314150247516	1	42,82	347
BHVG15-250	7314150403745	1	10,18	350
BHVIS06100	7314150167753	1	520,08	327
BHVIS06105	7314150167760	1	589,41	327
BHVIS0670	7314150167692	1	100,55	327
BHVIS0677	7314150167708	1	133,14	327
BHVIS0680	7314150167715	1	141,46	327
BHVIS0685	7314150167722	1	208,03	327
BHVIS0690	7314150167739	1	220,50	327
BHVIS0695	7314150167746	1	346,71	327
BHVIS08100	7314150165711	1	199,01	327
BHVIS08115	7314150165728	1	203,46	327
BHVIS0895	7314150165704	1	180,29	327
BHVIS109BPW12	7314150165759	1	213,17	327
BHVIS111BPW12	7314150165735	1	223,29	327
BHVIS120BPW16	7314150165742	1	247,55	327
BHVIS1265	7314150167685	1	88,74	327
BHVIS80BPW12	7314150165766	1	158,09	327
BHVIS95BPW9	7314150243334	1	163,65	327
BKE850901N	7314150449705	10	15,44	234
BLBT100	7314150179015	1	1.241,23	338
BLBT100AC1	7314150179022	1	321,82	338
BLCR230FR	7314150247356	1	262,57	352
BLCR230SC	7314150247349	1	262,57	352
BLCR400E	7314150247363	1	930,06	352
BLCRSC1	7314150247530	1	97,63	352
BLCRSC2	7314150247547	1	97,63	352
BLE300	7314150227648	1	192,77	337
BLE301	7314150227662	1	120,66	338
BLE302	7314150227679	1	127,36	338
BLE304	7314150249572	1	171,97	338
BLE305	7314150339341	1	157,14	337
BLEMAT1*	7314150477678	1	448,44	337
BLEMAT1BT*	7314150477685	1	88,98	337
BLT550	7314150243556	10	77,66	300
BLTFC1	7314150246434	20	97,86	352
BLTS10	7314150246427	20	63,86	352
BLTS7P	7314150246410	58	58,07	352
BMD150	7314150242238	1	13,16	337
BMMTRMS1	7314150274024	1	220,69	334
BMR240	7314150242245	1	23,59	337
BMVAT1000	7314150488360	50	139,99	334
BOD101	7314150205967	1	53,21	317
BOD1016	7314150169979	1	40,23	319
BOD101NWS	7314150269099	1	39,67	317
BOD101T	7314150269150	1	18,98	319
BOD102	7314150205974	1	56,27	317
BOD102NWS	7314150269105	1	44,19	317
BOD102T	7314150269167	1	23,65	319
BOD103	7314150205981	1	56,27	317
BOD103NWS	7314150269112	1	39,67	317
BOD103T	7314150269174	1	18,98	319
BOD104	7314150205998	1	60,82	317
BOD104NWS	7314150269129	1	43,70	317
BOD104T	7314150269181	1	24,42	319
BOD105	7314150206001	1	63,86	317
BOD105NWS	7314150269136	1	43,70	317
BOD105T	7314150269198	1	26,90	319
BOD106	7314150206018	1	69,20	317
BOD106NWS	7314150269143	1	58,53	317
BOD106T	7314150269204	1	23,00	319
BOD10P64	7314150205950	8	137,31	317
BOD2008	7314150169986	1	46,45	319
BOD2FS	7314150351879	20	15,86	319
BOD301200	7314150169993	1	29,13	318
BOD4200	7314150169436	1	10,12	318
BOD4500	7314150169443	1	12,34	318
BOD5400	7314150169450	1	36,79	319
BOD5450	7314150169474	1	61,13	319
BOD5HD400	7314150169467	1	56,80	319
BOD60	7314150169481	1	54,10	319
BOD6080P12	7314150235407	1	450,74	318
BOD6080P12-11	7314150235544	1	24,90	318
BOD70	7314150169498	1	157,09	319
BOD8901	7314150169016	1	568,60	318
BOD8901AC1	7314150178490	1	91,71	318
BOD8902	7314150169023	1	735,03	318
BOD8903A	7314150265374	1	825,17	318
BOM10X	7314150540549	10	39,25	355
BP-40	7314150453085	1	50,60	561
BP-40-95	7314150487097	12	3,97	561
BP110	7314150135011	1	228,41	282
BP111E*	7314150235872	12	318,63	282
BP115	7314150134991	1	208,74	281
BP117*	7314150184309	1	270,59	281
BP117EH	7314150184316	1	46,61	282
BP118*	7314150235834	1	246,24	281

\* Hasta agotar existencias

			€	
BP125A	7314150427291	6	718,86	288
BP127	7314150137565	1	405,86	283
BP12718	8414909179002	1	23,21	283
BP127P*	7314150427277	1	279,52	283
BP204*	7314150184286	1	278,30	284
BP20425180*	7314150185924	1	35,53	284
BP204K*	7314150184293	1	502,52	284
BP204PAD*	7314150185917	1	15,55	284
BP212	7314150134601	1	251,64	284
BP215A*	7314150341849	10	67,77	288
BP218	7314150170272	1	25,99	289
BP219	7314150235889	1	22,37	289
BP219L	7314150235896	1	26,01	289
BP219V*	7314150307197	1	74,06	289
BP219XL	7314150427192	10	23,23	289
BP222	7314150137572	1	262,86	285
BP233	7314150134748	1	373,41	286
BP254	7314150137633	1	146,84	289
BP255	7314150137640	1	220,24	289
BP255T*	7314150427307	1	275,64	290
BP255T-1	7314150427314	1	44,00	290
BP277K*	7314150427284	8	285,99	288
BP421M*	7314150134625	1	4,70	281
BP423M*	7314150134649	1	4,70	281
BP424M*	7314150134656	1	4,70	281
BP430M*	7314150134663	1	4,70	282
BP431M*	7314150134670	1	4,70	282
BP432M*	7314150134687	1	4,70	282
BP433M*	7314150134694	1	4,70	282
BP434M*	7314150135833	1	4,70	282
BP500*	7314150137992	1	57,10	289
BP601	7314150134526	1	405,86	284
BP60102	7314150426669	1	57,66	284
BP610	7314150134595	1	405,86	285
BP700	7314150134458	20	210,22	280
BP704	7314150427130	1	218,70	278
BP721*	7314150427185	1	187,65	280
BP799	7314150134502	1	208,61	288
BP79912	7314150134717	1	44,02	288
BP809*	7314150235841	1	418,67	285
BP80950	7314150275564	1	12,80	285
BP810*	7314150235858	1	364,37	285
BP811*	7314150235865	1	141,10	287
BP814*	7314150184262	10	262,57	278
BP814A	7314150304349	10	511,67	278
BP815	7314150134311	1	262,57	278
BP815K1*	7314150181957	1	383,76	278
BP817	7314150134106	1	639,58	279
BP820*	7314150134465	1	224,19	280
BP821	7314150134472	1	262,94	280
BP822	7314150134984	1	170,45	281
BP822E	7314150184279	10	208,74	281
BP823	7314150135004	1	432,92	282
BP825	7314150134496	1	370,49	285
BP826*	7314150137459	1	375,71	286
BP827*	7314150137442	1	417,24	286
BP828	7314150427260	1	284,69	286
BP830CISB*	7314150439799	1	37,80	283
BP830ESB*	7314150439751	1	28,06	283
BP830EWB*	7314150439768	1	28,06	283
BP830K*	7314150427208	4	537,04	283
BP830MISB*	7314150439782	1	37,80	283
BP830SBA*	7314150439805	1	24,59	283
BP830SSB*	7314150439775	1	37,80	284
BP830SW*	7314150439744	1	28,06	284
BP901	7314150336012	1	1.016,60	280
BP901L	7314150336029	1	1.030,05	280
BP905L	7314150336234	2	1.345,13	280
BP905P	7314150336210	2	1.339,75	280
BP909NE*	7314150187980	1	100,61	288
BP909NF*	7314150187973	1	82,03	287
BP909TE*	7314150187942	1	38,69	287
BP909TF*	7314150187911	1	30,19	287
BP909TH*	7314150187959	1	38,69	287
BP909TSP*	7314150187966	1	30,19	287
BP909TTP*	7314150187935	1	30,19	287
BP910	7314150427246	5	187,65	287
BP91BL	7314150192779	1	3,11	281
BP91BS	7314150192786	1	3,11	281
BPA823*	7314150427161	1	159,18	286
BPBG3515*	7314150134823	1	35,72	286
BPBG3525A*	7314150134830	1	35,72	286
BPBG3525B*	7314150134847	1	39,79	286
BPBG5725*	7314150134861	1	35,72	287
BPBG9057*	7314150134878	1	86,85	287
BPBL00900*	7314150358335	5	66,32	339
BPBL30900	7314150360451	5	66,32	339
BPBL70600*	7314150360468	5	58,32	339
BPBL90600*	7314150358366	5	59,32	339
BPBL54	7314150360475	2	244,61	339
BPBSC156*	7314150134816	1	52,57	286
BPBU18*	7314150134755	1	58,44	286
BPBU24*	7314150134762	1	58,44	286
BPBU36*	7314150134779	1	66,57	286
BPBU60*	7314150134786	1	71,44	286
BPBU90*	7314150134793	1	86,85	286







BPC813	7314150296408	10	262,57	278
BPC813K1*	7314150331253	1	354,47	278
BPC814	7314150296392	10	302,97	278
BPC815	7314150296385	1	316,43	278
BPC815K1*	7314150331208	1	609,96	279
BPC815K2	7314150331215	1	522,62	279
BPC815K3*	7314150331222	1	539,49	279
BPC815K4*	7314150331239	1	564,76	279
BPC815K6*	7314150331284	1	497,50	279
BPC817	7314150296422	4	720,38	279
BPC817K1*	7314150331260	1	1.068,27	279
BPC817K2*	7314150331277	1	1.049,94	280
BPC823*	7314150427147	1	161,75	285
BPC825*	7314150427154	1	188,93	285
BPCVB1	7314150384792	6	233,28	329
BPG824*	7314150427253	10	323,52	286
BPH1010A	7314150330010	1	48,69	290
BPH1010B	7314150341757	1	39,52	290
BPH1310A	7314150330003	1	88,20	290
BPHRC1015	7314150247400	1	296,22	290
BPHRC1020	7314150247417	1	402,61	290
BPHRC1316	7314150247455	1	437,62	290
BPHRC815	7314150247394	1	267,94	290
BPHRSC	7314150247448	1	97,63	290
BPHVLP01	7314150138937	1	200,62	288
BPHVLP0112	7314150165872	1	23,55	288
BPHVLP0114	7314150165889	1	23,55	288
BPHVLP0117	7314150165896	1	23,55	288
BPHVLP0120	7314150165902	1	23,55	288
BPNO10	7314150219728	1	207,98	289
BPN21201	7314150134731	1	146,12	285
BPN22201	7314150138074	1	172,10	285
BPN251	7314150137589	1	16,56	289
BPOC15	7314150360673	12	81,85	310
BPSJ	7314150427239	1	31,05	290
BPSJL	7314150439812	1	36,24	290
BS1000	7314150170081	1	402,19	331
BS100001	7314150232819	1	18,29	331
BS100002	7314150232826	1	18,29	331
BS100003	7314150232833	1	18,29	331
BS100004	7314150232840	1	18,29	331
BS100005	7314150232857	1	18,29	331
BS100006	7314150232864	1	18,29	331
BS100007	7314150232871	1	18,29	331
BS100008	7314150232888	1	18,29	331
BS100009	7314150232895	1	18,29	331
BS100010	7314150232901	1	14,96	331
BS100011	7314150232918	1	14,96	331
BS100012	7314150232925	1	14,96	331
BS100013	7314150232932	1	12,45	331
BS100014	7314150232949	1	12,45	331
BS100015	7314150232956	1	12,45	331
BS100016	7314150232963	1	12,45	331
BS100017	7314150232970	1	12,45	331
BS100018	7314150232987	1	12,45	331
BS100019	7314150232994	1	12,45	331
BS100020	7314150233007	1	12,45	331
BS100021	7314150233014	1	12,45	331
BS100022	7314150233021	1	14,96	331
BS100023	7314150233038	1	14,96	331
BS100024	7314150233045	1	14,96	331
BS100025	7314150233052	1	14,96	331
BS100026	7314150233069	1	14,96	331
BS100027	7314150233076	1	14,96	331
BS100028	7314150233083	1	14,96	331
BS100029	7314150233090	1	12,45	331
BS100030	7314150233106	1	12,45	331
BS100031	7314150233113	1	12,45	331
BS100032	7314150233120	1	12,45	331
BS100033	7314150233137	1	12,45	331
BS100034	7314150233144	1	12,45	331
BS100035	7314150233151	1	16,72	331
BS100036	7314150233168	1	16,72	331
BS100037	7314150233175	1	16,72	331
BS100038	7314150233182	1	16,72	331
BS100039	7314150233199	1	16,72	331
BS100PSA1	7314150249282	1	104,61	330
BS10AC2	7314150182343	1	610,22	331
BS15	7314150206117	1	686,50	331
BS25	7314150416103	1	234,60	331
BS30AC1	7314150383504	1	493,72	331
BS30PG	7314150436644	1	2.548,43	331
BS40VAG	7314150430642	20	65,87	329
BS45BMW*	7314150430659	20	36,60	329
BS52	7314150329212	1	256,56	329
BS5228341	7314150329229	1	91,53	328
BS5234401	7314150329236	1	91,53	328
BS5239451	7314150329243	1	91,53	328
BS54	7314150243341	1	66,57	329
BS56*	7314150430826	6	36,31	329
BS618	7314150242368	1	55,49	330
BS623	7314150242375	1	108,44	330
BSSHE3	7314150251858	1	104,50	328
BT10P3	7314150205639	1	127,58	338
BT10P325	7314150231706	40	42,15	339
BT10P330	7314150231713	1	46,05	339



BT10P338	7314150231720	1	52,53	339
BT15P5	7314150205837	1	83,63	327
BT15P524	7314150231737	1	12,99	327
BT15P530	7314150231744	1	15,61	327
BT15P532	7314150231751	1	16,81	327
BT15P536	7314150342129	1	22,41	327
BT20P26	7314150205820	1	714,23	329
BT20P49	7314150385041	1	2.599,39	330
BTL-3-13	7314150333349	12	7,47	526
BTL-6-13	7314150333356	12	9,54	526
BTR-3-13	7314150333332	12	7,47	526
BTR-6-13	7314150333363	12	9,54	526
BUC100	7314150169962	1	104,02	315
BUC110	7314150206025	1	47,85	315
BUC50	7314150182329	1	66,57	314
BUCKET - 1446-CS	7314150534555	1	666,25	571
BUCKET - EMPTY	7314150511037	6	16,97	571
BUCKET-1446-FLOAT	7314150539550	1	820,02	571
BUCPE	7314150243259	1	776,63	314
BUCPE3SDH	7314153024183	1	209,77	314
BUCPE3SH	7314150243471	1	206,03	314
BUCPEF	7314150244942	1	80,24	314
BUCPEF1	7314150245116	1	6,94	314
BWB14	7314150170166	2	499,02	329
BWB1418S4	7314150365593	6	75,16	337
BWB1922S4*	7314150365609	6	84,72	337
BWBB	7314150407828	200	8,66	325
BWC1	7314150365586	25	17,77	326
BWHEHS	7314150251841	1	253,13	328
BWHEP	7314150251834	1	242,84	328
BWHEPS	7314150264087	1	471,24	327
BWHEPSH8	7314150264889	1	616,25	327
BWHEPSSH8	7314150264896	1	997,30	327
BWHPJ12	7314150403257	4	313,26	330
BWHTRS12*	7314150384808	163	226,61	325
BWMSP15	7314150239740	1	106,56	363
BWMSP1501	7314150239757	1	5,27	363
BWMSP1502	7314150239764	1	5,27	363
BWMSP1503	7314150239771	1	5,27	363
BWMSP1504	7314150239788	1	5,27	363
BWMSP1505	7314150239795	1	5,27	363
BWMSP1506	7314150239801	1	5,27	363
BWMSP1507	73141503024176	1	5,27	363
BWMSP1508	7314150239818	1	5,27	363
BWMSP1509	7314150239825	1	5,27	363
BWMSP1510	7314150239832	1	5,27	363
BWMSP1511	7314150239849	1	5,27	363
BWMSP1512	7314150239856	1	5,75	363
BWMSP1513	7314150239863	1	5,75	363
BWMSP1514	7314150239870	1	5,75	363
BWMSP1515	7314150239887	1	5,75	363
BWP150	7314150170159	1	24,97	326
BWSH5	7314150251810	2	353,20	328
BWSH51	7314150251827	1	18,86	328
BWSH8	7314150255191	1	457,70	328
BWSHK21	7314150403271	25	17,33	324
BWSMB15	7314150365074	25	14,89	323
BWSMB17	7314150329656	1	16,63	324
BWSS12P3	7314150170128	20	41,47	323
BWSS12P317	7314150203451	1	13,73	323
BWSS12P317L	7314150330065	1	24,69	324
BWSS12P319	7314150203468	1	14,57	323
BWSS12P319L	7314150330072	1	24,82	324
BWSS12P321	7314150203475	1	14,57	323
BWSS12P321L*	7314150330089	1	24,97	324
BWSS12P3L	7314150330096	1	99,97	324
BWSS12P5	7314150170135	1	63,80	323
BWSS12P522	7314150203482	1	16,63	323
BWSS12P524	7314150203499	1	16,63	323
BWTB12P100	7314150329830	1	24,27	325
BWTB12P110	7314150329847	1	24,27	325
BWTB12P120	7314150329854	1	24,27	325
BWTB12P135	7314150329861	1	24,27	325
BWTB12P150	7314150329878	1	24,27	325
BWTB12P160	7314150329885	1	24,27	325
BWTB12P175	7314150329892	1	24,27	325
BWTB12P190	7314150329908	1	24,27	325
BWTB12P200	7314150329915	1	24,27	325
BWTB12P5	7314150329991	1	123,44	325
BWTB12P90	7314150329923	1	24,27	325
BWTDG1	7314150403400	50	39,33	326
BWTPG1*	7314150351886	10	54,92	326
BWTPMSS4C	7314150347100	25	35,37	327
BWTPMSS9	7314150347124	8	331,45	326
BWTSP16	7314150170296	1	300,34	325
BWTSP1608	7314150203284	1	24,93	325
BWTSP1610	7314150203291	1	15,73	325
BWTSP1611	7314150203307	1	15,73	325
BWTSP1612	7314150203314	1	15,73	325
BWTSP1613	7314150203321	1	15,73	325
BWTSP1614	7314150203338	1	15,73	325
BWTSP1616	7314150203345	1	16,85	325
BWTSP1617	7314150203352	1	16,85	325
BWTSP1618	7314150203369	1	16,85	325
BWTSP1619	7314150203376	1	16,85	325
BWTSP1621	7314150203383	1	32,86	325



BWTSP1622	7314150203390	1	33,21	325
BWTSP1624	7314150203406	1	33,98	325
BWTSP1627	7314150203413	1	34,63	325
BWTSP317L	7314150335480	1	41,54	324
BWTSP319L	7314150335497	1	45,07	324
BWTSP321L	7314150335503	1	48,88	324
BWTSP3L	7314150335473	1	136,60	324
BWTSP6	7314150240043	1	97,38	324
BWTSP617	7314150242399	1	19,50	324
BWTSP619	7314150242405	1	19,50	324
BWTSP621	7314150242412	1	19,50	324
BWTSP622	7314150242429	1	20,24	324
BWTSP624	7314150242436	1	20,24	324
BWTSP7	7314150170302	1	274,33	324
BWTSP732	7314150203420	1	80,46	325
BWTSP736	7314150203437	1	95,50	325
BWTSP741	7314150203444	1	111,23	325
BWTVCTT355	7314150347179	1	28,97	326
BWXW1	7314150167661	1	36,06	323
BWXW2	7314150167678	4	108,17	323
BWXW3	7314150214624	1	33,29	323
BWXW4	7314150214631	1	112,35	323
BZWTB0132450*	7314150165674	1	181,78	325
BZWTB0132600*	7314150165681	1	181,78	325
C0312I03	7314150501298	5	13,91	153
C0313M03	7311518100636	1	14,96	150
C0313M03X	7311518182045	1	15,57	150
C0616AL06	7311518181826	1	34,46	151
C0616M03X	7311518204679	1	31,77	150
C0616M06	7311518100667	1	28,66	150
C0616M06X	7311518100681	1	30,11	150
C0618I06	7314150501311	5	24,66	153
C0618S06	7314150501342	5	22,63	152
C0820M06	7311518100711	1	41,12	150
C0820M06X	7311518100735	1	43,19	150
C1020I06	7314150501373	5	33,20	153
C1020M06	7311518100766	1	41,95	150
C1020M06X	7311518100780	1	44,02	150
C1020S06	7314150501403	5	30,45	152
C1225AL06	7311518187637	1	65,84	151
C1225I06	7314150506743	5	63,07	153
C1225M06	7311518100810	1	62,30	150
C1225M06X	7311518100834	1	69,45	150
C1225M08X	7311518187996	1	65,84	150
C1225S06	7314150501465	5	47,85	152
C1625M06	7311518192266	1	76,22	150
C1625M06X	7311518187378	1	79,96	150
C1625M08	7311518100902	1	76,22	150
C1625M08X	7311518100926	1	79,96	150
C1997LM/9P	7314150510375	1	37,87	231
C1997TORX/9P	7314150510382	1	37,87	232
C3230IP*	7314150391189	10	50,16	241
C3330R IP*	7314150391202	10	35,93	238
C3340R IP	7314150391219	10	37,33	238
C3430	7314150393367	10	37,70	249
C3430IP	7314150391226	10	37,28	249
C3530	7314150393374	10	38,06	250
C3530IP	7314150391233	10	37,28	250
C3630	7314150393381	10	42,36	245
C3630IP	7314150391240	10	41,51	245
C3640	7314150393398	10	43,60	245
C3640IP	7314150391257	10	42,61	245
C3745	7314150393404	10	40,33	247
C3745IP	7314150391264	10	39,67	247
C3790	7314150393411	10	40,71	247
C3790IP	7314150391271	10	39,67	247
C3830	7314150393428	10	38,06	245
C3830IP	7314150391288	10	37,31	245
C3840*	7314150393435	10	38,06	245
C3840IP	7314150391295	10	37,33	245
C3902/3	7314150399604	1	116,39	261
C3903/2-6	7314150466481	1	117,03	261
CFP250	7314150400669	6	24,49	598
CFP250-DISP*	7314150400690	12	25,94	598
CHALK-BLUE	7314150128686	6	3,18	530
CHALK-RED	7314150128709	6	3,18	530
CHALK-WHITE	7314150179671	6	3,38	530
CHALK-YELLOW	7314150128693	6	3,18	530
CL-1221	73141501271122	6	12,54	530
CL-1221-SET	7314150188574	4	18,21	530
CL-1331	7314150347728	48	19,32	530
CL-1441	7314150347735	36	25,00	530
CL-1441-SET	7314150360758	16	32,85	530
CLIPS-1/2	7314153003201	25	0,39	99
CLIPS-1/4	7314153003188	25	0,38	85
CLIPS-3/8	7314153003195	25	0,38	92
CR B 01	7314150215409	60	28,45	258
CR B 02	7314150215416	60	27,37	258
CR B 03	7314150215423	60	27,85	258
CR B 05	7314150215454	2	55,37	258
CR B 06	7314150215461	2	110,73	258
CR L 01	7314150215911	1	410,64	260
CR L 02	7314150215928	1	303,30	260
CR L 03	7314150215935	1	461,98	260
CR OV 01	7314150489978	1	162,19	258
CR SA H01	7314150489992	1	225,91	260

\* Hasta agotar existencias



CR SA H16	7314150508990	1	247,66	260
CR SA S01	7314150490011	1	218,96	260
CR SA T01	7314150490035	1	214,32	260
CR W 01	7314150215492	1	160,22	259
CR W 02	7314150215508	1	133,76	259
CR W 03	7314150215515	1	133,76	259
CR W 04	7314150215522	1	139,85	259
CR W 05	7314150215539	1	142,02	259
CR W 06	7314150215546	1	150,10	259
CS-SPARE	7314150453030	1	4,57	532
CS150	7314150125241	12	13,13	532
CS300	7314150125258	12	24,43	532
CS400	7314150125265	12	27,19	532
D-DD/S20	7311518280345	4	97,59	185
D/S10	7311518280307	6	63,10	185
D/S14	7311518280314	6	86,22	185
D0303I03	7314150501281	5	13,91	153
D0303M03	7311518100957	1	19,01	150
D0303M03X	7311518182052	1	19,90	150
D0605M03X	7311518197896	1	30,60	150
D0606I06	7314150501328	5	22,67	153
D0606M06	7311518100988	1	29,08	150
D0606M06X	7311518101008	1	30,60	150
D0606S06	7314150501359	5	20,78	152
D0807M06	7311518043896	1	29,95	150
D0807M06X	7311518043919	1	31,48	150
D1009M06	7311518035280	1	31,04	150
D1009M06X	7311518035297	1	32,56	150
D1009M06X-69	7311518224288	1	39,45	150
D1010I06	7314150501380	5	27,25	153
D1010S06	7314150501410	5	24,97	152
D1211AL06	7311518187644	1	52,04	151
D1211AL08	7311518181840	1	52,04	151
D1211M06	7311518035334	1	43,28	150
D1211M06X	7311518035358	1	45,47	150
D1212I06	7314150501441	5	36,76	153
D1212S06	7314150501472	5	33,68	152
D1614M06	7311518192327	1	64,11	150
D1614M06X	7311518187385	1	63,83	150
D1614M08	7311518035389	1	60,77	150
D1614M08X	7311518035402	1	63,85	150
DD/S10	7311518280321	6	62,14	185
DD/S14	7311518280338	4	99,67	185
DOW 175-1	7314152202728	1	40,75	270
DOW 175-11/2	7314152202995	1	55,92	270
DOW 175-2	7314152203022	1	87,67	270
DOW 175-3	7314152203299	1	146,07	270
DOW 176-1	7314152206047	1	53,01	271
DOW 176-11/2	7314152206122	1	68,14	271
DOW 176-2	7314152206399	1	93,80	271
DOW 177-1/2-1	7314152816383	1	50,57	270
DOW 177-11/2	7314152816468	1	64,26	270
DOW 177-2	7314152816543	1	96,02	270
E0308M03	7311518035433	1	24,48	150
E0308M03X	7311518192372	1	25,80	150
E0614M06	7311518035464	1	41,96	150
E0816M06	7311518035518	1	47,54	150
E0816M06X	7311518035532	1	47,35	150
E1015I06	7314150501496	5	33,20	153
E1018M06	7311518035563	1	50,25	150
E1018M06X	7311518035587	1	52,75	150
E1220I06	7314150501526	5	48,63	153
E1222M06	7311518035617	1	57,73	150
E1222M06X	7311518035631	1	60,65	150
E1222M08	7311518172558	1	60,78	150
E1222M08X	7311518199302	1	63,85	150
E1625M06	7311518192440	1	93,04	150
E1625M06X	7311518187392	1	102,33	150
E1625M08	7311518035709	1	93,04	150
E1625M08X	7311518035723	1	97,60	150
EDGE-LAUNCH1	7314150545230	1	139,05	628
EX-14-TEN-C	7311518298333	5	37,72	551
EX-14-VEN-C	7311518298340	10	31,75	551
EX-16-GNP-C	7311518298685	10	33,07	548
EX-19-XT9-C	7311518298302	10	43,98	550
EX-20-LAM-C	7311518298326	10	46,48	551
EX-20-XT11-C	7311518298319	10	45,52	551
EX-22-PLS-C	7311518298357	10	41,55	548
EX-22-U7	7311518300890	10	15,95	550
EX-22-XT7-C	7311518298289	10	45,52	552
EX-22-XT9-C	7311518298296	10	45,52	550
EX-24-XT7-C	7311518298272	10	47,12	552
EX-24LP-22	7311518298456	10	23,78	552
EX-24L	7311518298494	4	40,75	554
EX-NPP-22	7311518324162	10	19,47	550
EX-LR	7311518298487	4	40,75	554
EX-RL	7311518298470	4	40,75	554
F0312I03	7314150501502	5	13,91	153
F0313M03	7311518035754	1	14,96	150
F0313M03X	7311518192495	1	15,78	150
F0613M03X	7311518196608	1	32,88	150
F0618AL06	7311518181857	1	44,02	152
F0618I06	7314150501533	5	25,75	153
F0618M06	7311518035792	1	36,76	150
F0618M06X	7311518035815	1	38,64	150
F0618S06	7314150501564	5	23,62	152





F0820M06	7311518035839	1	48,38	150
F0820M06X	7311518035860	1	50,88	150
F1020I06	7314150501595	5	32,50	153
F1020M06	7311518035891	1	47,14	150
F1020M06X	7311518035914	1	49,43	150
F1020S06	7314150501625	5	29,78	152
F1225AL06	7311518187651	1	59,81	152
F1225AL08	7311518181864	1	59,81	152
F1225I06	7314150501656	5	48,06	153
F1225M06	7311518035945	1	59,81	150
F1225M06X	7311518036003	1	62,72	150
F1225M08	7311518035983	1	59,81	150
F1225M08X	7311518192563	1	62,72	150
F1225S06	7314150501687	5	44,04	152
F1625M06	7311518192570	1	91,58	150
F1625M06X	7311518187408	1	91,17	150
F1625M08	7311518036034	1	91,39	150
F0820M06	7311518123970	4	84,34	586
F0820M06X	7311518123994	2	93,82	586
F0820M08	7314150321551	6	25,98	533
F0820M08X	7314150321537	6	22,34	533
F0820M10	7314150321544	6	23,73	533
F0820M12	7314150228560	1	720,62	388
F0820M14	7314150228591	1	264,98	388
F0820M16	7314150228607	1	214,54	388
F0820M18	7314150227778	1	483,22	389
F0820M20	7314150478446	1	739,65	389
F0820M22	7314150227822	1	427,00	389
F0820M24	7314150227846	1	256,65	389
F0820M26	7314150227976	1	1.701,56	390
F0820M28	7314150227990	1	540,62	390
F0820M30	7314150286454	1	148,96	390
F0820M32	7314150339068	1	115,83	390
F0820M34	7314150334841	1	362,30	390
F0820M36	7314150335541	1	336,77	391
F0820M38	7314150228034	1	713,78	391
F0820M40	7314150335619	1	267,48	391
F0820M42	7314150335572	1	294,22	391
F0820M44	7314150335633	1	355,01	391
F0820M46	7314150335640	1	239,38	391
F0820M48	7314150335701	1	234,64	392
F0820M50	7314150228058	1	405,38	392
F0820M52	7314150335718	1	346,50	392
F0820M54	7314150335725	1	207,58	392
F0820M56	7314150336395	1	256,41	392
F0820M58	7314150228072	1	1.619,82	392
F0820M60	7314150336661	1	732,59	393
F0820M62	7314150336678	1	268,61	393
F0820M64	7314150336685	1	396,83	393
F0820M66	7314150336692	1	158,72	393
F0820M68	7314150336708	1	219,78	393
F0820M70	7314150336715	1	671,54	394
F0820M72	7314150336722	1	451,77	394
F0820M74	7314150336739	1	671,54	394
F0820M76	7314150336746	1	262,52	394
F0820M78	7314150336753	1	195,36	394
F0820M80	7314150228089	1	716,47	395
F0820M82	7314150336777	1	757,01	395
F0820M84	7314150338580	1	262,52	395
F0820M86	7314150338603	1	311,35	395
F0820M88	7314150338610	1	634,90	395
F0820M90	7314150228096	1	791,35	396
F0820M92	7314150350445	1	364,73	396
F0820M94	7314150228102	1	577,22	396
F0820M96	7314150350995	1	226,59	396
F0820M98	7314150351800	1	295,03	396
F0820M100	7314150228126	1	333,72	396
F0820M102	7314150358694	1	185,66	397
F0820M104	7314150254354	1	466,77	397
F0820M106	7314150431496	1	696,29	397
F0820M108	7314150455850	1	413,05	383
F0820M110	7314150455874	1	519,26	383
F0820M112	7314150455881	1	436,66	383
F0820M114	7314150455898	1	295,03	383
F0820M116	7314150455904	1	625,48	384
F0820M118	7314150254361	1	524,96	397
F0820M120	7314150455928	1	507,46	384
F0820M122	7314150455935	1	271,44	384
F0820M124	7314150455966	1	177,03	384
F0820M126	7314150455973	1	165,22	384
F0820M128	7314150455980	1	271,44	384
F0820M130	7314150455997	1	271,44	385
F0820M132	7314150456000	1	377,65	385
F0820M134	7314150456017	1	460,26	385
F0820M136	7314150456024	1	401,25	385
F0820M138	7314150456031	1	330,44	385
F0820M140	7314150456062	1	448,45	385
F0820M142	7314150456079	1	200,62	386
F0820M144	7314150456086	1	224,23	386
F0820M146	7314150437283	1	1.014,92	386
F0820M148	7314150456093	1	354,04	386
F0820M150	7314150456109	1	306,84	386
F0820M152	7314150456123	1	236,02	387
F0820M154	7314150456130	1	649,08	387
F0820M156	7314150456147	1	377,65	387
F0820M158	7314150254385	1	862,83	397



FF1A220LM	7314150456154	1	318,64	387
FF1A221LM	7314150456161	1	590,08	387
FF1A222LM	7314150456178	1	401,25	387
FF1A223LM	7314150456185	1	342,24	388
FF1A224LM	7314150456192	1	283,24	388
FF1A225LM	7314150456208	1	295,03	388
FF1A23	7314150254392	1	478,23	398
FF1A230	7314150461455	1	526,14	398
FF1A230I	7314150286508	1	823,74	398
FF1A235	7314150500666	1	443,65	398
FF1A236	7314150500680	1	466,80	398
FF1A24	7314150254408	1	423,45	398
FF1A25	7314150254415	1	669,15	399
FF1A250I	7314150286492	1	1.006,08	399
FF1A2503	7314150320677	1	702,06	399
FF1A26	7314150254422	1	483,73	399
FF1A28	7314150254446	1	566,97	400
FF1A300I	7314150286515	1	282,14	400
FF1A3002	7314150289264	1	357,75	400
FF1A3003	7314150286522	1	316,92	400
FF1A3004	7314150286676	1	551,88	400
FF1A3005	7314150286638	1	586,07	400
FF1A36	7314150265862	1	498,47	400
FF1A37	7314150265855	1	363,52	401
FF1A400I	7314150286713	1	445,68	401
FF1A4002	7314150286560	1	400,21	401
FF1A4003	7314150286706	1	325,97	401
FF1A48	7314150271801	1	382,68	401
FF1A50	7314150271825	1	545,05	401
FF1A5002	7314150286447	1	337,23	402
FF1A5003	7314150286690	1	1.064,04	402
FF1A5004	7314150286539	1	757,01	402
FF1A5005	7314150286546	1	1.050,04	402
FF1A5006	7314150286683	1	511,59	403
FF1A5007	7314150286553	1	768,60	403
FF1A5008	7314150286607	1	565,32	403
FF1A5009	7314150286669	1	499,39	403
FF1A5010	7314150286584	1	358,54	403
FF1A5011	7314150286614	1	360,18	404
FF1A5012	7314150286652	1	278,38	404
FF1A5013	7314150286577	1	554,33	404
FF1A5019	7314150309436	1	610,48	404
FF1A5021	7314150309467	1	302,08	404
FF1A5022	7314150309474	1	429,04	404
FF1A5023	7314150309498	1	283,12	405
FF1A5024	7314150309504	1	654,62	405
FF1A5028	7314150320691	1	274,72	405
FF1A5032	7314150320738	1	695,95	405
FF1A5036	7314150339037	1	268,61	406
FF1A51	7314150271832	1	323,14	406
FF1A54	7314150288786	1	277,06	406
FF1A65	7314150313389	1	454,82	406
FF1A66	7314150313396	1	314,03	406
FF1A67	7314150313402	1	389,20	406
FF1A68	7314150313419	1	274,72	406
FF1A70	7314150320189	1	326,98	407
FF1A71	7314150320196	1	201,47	407
FF1A72	7314150320202	1	357,44	407
FF1A82	7314150334070	1	200,62	407
FF1ASET-AUTO	7314150437993	1	3.387,45	381
FF1ASET-AUTO-M1	7314150438259	1	914,61	382
FF1ASET-AUTO-M2	7314150438327	1	1.852,83	382
FF1ASET-AUTO-M3	7314150438334	1	950,02	382
FF1ASET-AUTO-M4	7314150438341	1	1.357,17	382
FF1ASET-AUTO-M5	7314150438358	1	590,08	383
FF1ASET-AUTO-M6	7314150438365	1	1.079,83	383
FF1ASET-AUTO1	7314150254453	1	2.469,92	381
FF1ASET-AUTO2	7314150254460	1	1.745,31	381
FF1ASET-AUTO3	7314150254477	1	1.488,24	381
FF1ASET-AUTO6	7314150319909	1	1.452,87	382
FF1ASET-BASIC	7314150437368	1	928,82	380
FF1ASET-LARGE	7314150437108	1	2.130,82	380
FF1ASET-MRO2	7314150336623	1	2.918,79	380
FF1ASET-MRO3	7314150336630	1	2.106,17	380
FF1ASET-MRO4	7314150336647	1	1.416,32	381
FF1ASET-MRO5	7314150336654	1	1.129,53	381
FF1ASET-XLARGE	7314150436965	1	4.885,81	380
FF1B01LM	7314150455416	1	684,49	378
FF1B02LM	7314150455447	1	885,11	378
FF1B03LM	7314150455454	1	625,48	378
FF1B04LM	7314150455478	1	767,09	378
FF1B05LM	7314150455515	1	767,09	379
FF1B06LM	7314150455522	1	413,05	379
FF1B07LM	7314150455614	1	708,08	379
FF1B08LM	7314150455645	1	413,05	379
FF1B09LM	7314150455669	1	330,44	379
FF1B10LM	7314150455706	1	436,66	380
FF1B11LM	7314150455713	1	424,85	380
FF1BSET-MONSTER	7314150436835	1	7.074,97	377
FF1E1001	7314150285839	1	96,46	414
FF1E1002	7314150285761	1	92,80	414
FF1E1003	7314150285853	1	87,91	414
FF1E1004	7314150285754	1	97,67	414
FF1E1005	7314150285785	1	89,14	414
FF1E1006	7314150285778	1	91,57	414
FF1E1007	7314150285792	1	79,36	414



			€	
FF1E1008	7314150285822	1	94,02	414
FF1E1009	7314150285808	1	73,26	414
FF1E1009EH	7314150352579	1	53,11	422
FF1E1010	7314150285815	1	89,14	415
FF1E1011	7314150285846	1	105,01	415
FF1E1012EH	7314150352562	1	53,11	421
FF1E1013EH	7314150352586	1	94,41	422
FF1E2001	7314150285945	1	326,40	415
FF1E2002	7314150285921	1	344,31	415
FF1E2003	7314150286072	1	205,12	415
FF1E2004	7314150285952	1	216,55	415
FF1E2005	7314150285976	1	182,73	416
FF1E2006	7314150285914	1	333,25	416
FF1E2007	7314150285907	1	187,73	416
FF1E2008	7314150285860	1	195,51	416
FF1E2009EH	7314150352593	1	112,12	422
FF1E2010EH	7314150352654	1	59,01	422
FF1E2011EH	7314150373802	1	70,81	423
FF1E2101	7314150285877	1	284,48	416
FF1E2102	7314150286058	1	301,57	416
FF1E2103	7314150286089	1	363,65	417
FF1E2104	7314150285990	1	262,69	417
FF1E2105	7314150286041	1	334,55	417
FF1E2106EH	7314150352623	1	106,21	422
FF1E2107EH	7314150352661	1	76,71	422
FF1E2201	7314150286010	1	271,99	417
FF1E2202	7314150285891	1	240,29	417
FF1E2203	7314150285884	1	252,87	417
FF1E2204	7314150285983	1	199,12	418
FF1E2205	7314150285938	1	280,82	418
FF1E2206	7314150286034	1	275,94	418
FF1E2207	7314150285969	1	290,60	418
FF1E2208	7314150286027	1	168,77	418
FF1E2209	7314150286096	1	295,48	418
FF1E2210	7314150286065	1	231,99	418
FF1E2211	7314150339006	1	323,55	419
FF1E2212	7314150339013	1	128,21	419
FF1E2213	7314150339020	1	256,41	419
FF1E2214EH	7314150352647	1	236,02	422
FF1E2215EH	7314150352678	1	94,41	422
FF1E2216EH	7314150373833	1	147,52	423
FF1E2501	7314150286003	1	226,90	419
FF1E2502	7314150338993	1	97,67	419
FF1E2503EH	7314150352685	1	147,52	422
FF1E2504EH	7314150374106	1	94,41	423
FF1E2505EH	7314150373826	1	94,41	424
FF1E3001	7314150286119	1	115,22	420
FF1E3002	7314150286102	1	89,89	420
FF1E3003	7314150286157	1	122,63	420
FF1E3004	7314150286133	1	285,70	420
FF1E3005	7314150286126	1	252,74	420
FF1E3006	7314150286140	1	305,24	420
FF1E3007	7314150286164	1	95,23	420
FF1E3008	7314150286171	1	200,24	420
FF1E3009EH	7314150352722	1	88,51	422
FF1E3010EH	7314150352739	1	94,41	422
FF1E3011EH	7314150352753	1	112,12	423
FF1E4001	7314150285747	1	146,26	421
FF1E4002	7314150285730	1	104,76	421
FF1E4003EH	7314150352692	1	100,31	423
FF1E4004EH	7314150352708	1	112,12	423
FF1E4005EH	7314150352807	1	123,92	423
FF1E5001	7314150285716	1	207,38	421
FF1E5002	7314150285709	1	115,98	421
FF1E5003	7314150285723	1	109,88	421
FF1E5004	7314150338931	1	103,77	421
FF1E5005	7314150338948	1	164,84	419
FF1E5006	7314150338955	1	122,10	419
FF1E5007	7314150338962	1	177,05	421
FF1E5008	7314150338979	1	115,98	421
FF1E5009	7314150338986	1	85,47	420
FF1E5010EH	7314150352746	1	106,21	423
FF1E5011EH	7314150352777	1	100,31	423
FF1E5013EH	7314150352821	1	94,41	423
FF1E5014EH	7314150373864	1	106,21	424
FF1E5015EH	7314150373871	1	59,01	424
FF1E5016EH	7314150373888	1	29,50	424
FF1F1001	7314150286270	1	115,98	407
FF1F1002	7314150286287	1	158,58	407
FF1F1003	7314150286294	1	194,13	408
FF1F1004	7314150286263	1	144,07	408
FF1F1005	7314150286300	1	227,10	408
FF1F1006	7314150286249	1	133,10	408
FF1F1007	7314150286256	1	100,12	408
FF1F1008	7314150339129	1	134,31	408
FF1F1009	7314150339136	1	115,98	408
FF1F2001	7314150286317	1	465,27	409
FF1F2002	7314150339143	1	164,84	409
FF1F2101	7314150286331	1	577,52	409
FF1F2102	7314150339105	1	183,14	409
FF1F2103	7314150339112	1	141,61	409
FF1F2201	7314150286324	1	426,12	409
FF1F2202	7314150339150	1	189,25	410
FF1F2203	7314150339167	1	378,49	410
FF1F3001	7314150286348	1	117,03	410
FF1F3002	7314150286379	1	204,24	410

\* Hasta agotar existencias

			€	
FF1F3003	7314150286409	1	272,55	410
FF1F3004	7314150286386	1	164,84	410
FF1F3005	7314150286362	1	428,56	411
FF1F3006	7314150286355	1	280,82	411
FF1F3007	7314150286393	1	184,30	411
FF1F3008	7314150286423	1	424,91	411
FF1F3009	7314150286416	1	280,82	411
FF1F3010	7314150339082	1	201,47	411
FF1F3011	7314150339099	1	207,58	411
FF1F4001	7314150286195	1	297,92	411
FF1F4002	7314150286201	1	277,16	412
FF1F4003	7314150286225	1	159,68	412
FF1F4004	7314150286232	1	198,84	412
FF1F4005	7314150286218	1	224,78	412
FF1F5001	7314150286188	1	221,71	412
FF1F5002	7314150339174	1	134,31	412
FF1F5003	7314150339181	1	195,36	412
FF1F5004	7314150339198	1	177,05	410
FF1F5005	7314150339204	1	91,57	413
FF1F5006	7314150339211	1	335,76	413
FF1F5007	7314150339228	1	207,58	413
FF1F5008	7314150339235	1	109,88	413
FF1F5009	7314150339242	1	250,31	413
FF1F5010	7314150339259	1	213,67	413
FF1F5011	7314150339266	1	938,22	413
FF1F5012	7314150339273	1	439,56	413
FF1F5013	7314150339280	1	219,50	410
FF2A07	7314150228201	1	1.034,27	431
FF2A08	7314150228225	1	461,07	432
FF2A09	7314150228249	1	532,55	432
FF2A10	7314150228263	1	568,37	432
FF2B01	7314150233441	1	1.001,14	432
FF2B02	7314150233465	1	751,87	432
FF2B03	7314150233489	1	820,32	433
FF2B04	7314150233502	1	464,22	433
FF2B05	7314150233526	1	765,76	433
FF2B06	7314150233540	1	110,23	433
FF2B07	7314150229420	1	987,38	433
FF2B08	7314150229451	1	461,29	433
FF2B09	7314150229482	1	548,96	434
FF2B10	7314150229505	1	511,18	434
FF2B11	7314150229529	1	127,53	434
FF2B12	7314150229543	1	1.114,44	434
FF2B13	7314150229567	1	504,50	434
FF2B14	7314150229581	1	352,71	434
FF2B15	7314150229604	1	353,65	435
FF2B16	7314150229628	1	87,79	435
FF2C01	7314150327287	1	401,26	435
FF3A01	7314150228300	1	997,22	443
FF3A02	7314150228324	1	277,34	444
FF3A03	7314150228348	1	483,16	444
FF3A04	7314150228362	1	529,83	444
FF3A05	7314150228386	1	1.103,37	444
FF3A06	7314150228416	1	294,73	444
FF3A07	7314150228430	1	481,60	445
FF3A08	7314150228454	1	382,94	445
FF3A09	7314150228478	1	1.155,92	445
FF3A10	7314150228492	1	262,22	445
FF3A11	7314150228515	1	348,46	445
FF3A12	7314150228539	1	379,38	446
FF3A13	7314150228614	1	694,17	446
FF3A14	7314150228638	1	944,84	446
FF3A15	7314150228652	1	267,38	446
FF3A16	7314150228676	1	475,01	446
FF3A17	7314150228690	1	468,73	447
FFSS-1.5-900FG	7311518275884	4	70,03	586
FGS-1.0-600	7311518123796	4	47,78	586
FGS-1.25-700	7311518123802	4	50,36	586
FGS-1.25-700-WB	7314150398720	4	53,23	586
FGS-1.6-810	7311518123819	4	56,74	586
FGS-1.6-810-WB	7314150399086	4	59,64	586
FGS-1.8-810	7311518123826	4	61,74	586
FM10	7311518010881	5	19,11	33
FM12	7314150273249	5	19,11	33
FP-3M	7311518168612	1	101,92	613
FS-5	7311518266455	10	16,80	618
FS-7.5	7311518266479	10	28,21	618
FS-8	7311518266462	10	22,87	618
G0313M03	7311518036089	1	14,96	150
G0313M03X	7311518182069	1	15,57	150
G0613M03X	7311518196592	1	31,16	150
G0618M06	7311518036119	1	32,42	150
G0618M06X	7311518036133	1	32,20	150
G0820M06	7311518036164	1	41,53	150
G0820M06X	7311518036188	1	43,61	150
G1020I06	7314150501519	5	34,67	153
G1020M06	7311518036218	1	50,25	150
G1020M06X	7311518036232	1	52,75	150
G1020S06	7314150501540	5	31,77	152
G1225I06	7314150501571	5	47,13	153
G1225M06	7311518036317	1	58,77	150
G1225M06X	7311518036331	1	61,68	150
G1225M08	7311518036362	1	61,87	150
G1225M08X	7311518188009	1	61,68	150
G1225S06	7314150501601	5	43,21	152
G1625M06	7311518192648	1	79,54	150





# G1625M06X



G1625M06X	7311518187415	1	83,48	150
G1625M08	7311518036409	1	79,54	150
G1625M08X	7311518036423	1	83,48	150
GL008-10	7314150167050	5	20,26	478
GL008-8	7314150167043	5	20,26	478
GL010-10	7314150167098	5	25,73	478
GL010-8	7314150167081	5	25,73	478
GS-180-F	7311518275488	6	29,48	618
GS-76	7311518010782	8	21,61	617
H0613M03X	7311518196615	1	32,80	150
H1020I06	7314150501717	5	59,17	153
H1025M06	7311518182304	1	57,93	150
H1025M06X	7311518182311	1	60,77	150
H1232I06	7314150501748	5	69,58	153
H1232M06	7311518182076	1	71,48	150
H1232M06X	7311518181758	1	74,98	150
H1635M06	7311518192730	1	89,20	150
H1635M06X	7311518187422	1	93,57	150
H1635M08	7311518182083	1	89,20	150
H1635M08X	7311518182090	1	98,70	150
HFGPS-0,7-400FG	7311518275877	4	46,85	586
HGPS-0,6-360	7311518123680	10	23,97	586
HGPS-0,8-380	7311518123697	4	29,30	586
HGPS-0,8-380-WB	7314150398812	4	33,94	586
HGPS-1,0-400	7311518123703	4	32,78	586
HGPS-1,0-400-WB	7314150398713	4	35,79	586
HRFM10	7311518010898	5	23,33	33
HS6000	7314150113781	10	66,95	633
HS6001	7314150476466	10	66,95	633
HUS-0,6-380	7311518123659	4	34,54	586
HUS-0,8-500	7311518123666	4	38,63	586
HUS-1,0-650	7311518123673	4	43,47	586
IZO-D-135	7314151845827	1	768,33	111
IZO-D-200	7314151846831	1	842,36	111
IZO-D-30	7314151846824	1	768,33	111
IZO-D-340	7314151846848	1	970,67	111
IZO-DR-810	7314151846817	1	2.306,91	112
J0604M06	7311518036508	1	37,58	151
J1010M06	7311518172473	1	41,96	151
J1212M06	7311518036577	1	49,57	151
J1616M06	7311518187439	1	72,64	151
J1616M08	7311518036614	1	68,86	151
K-AP-1	7311518030117	10	32,38	623
K-GP-1	7311518030131	10	35,40	623
K0602M06	7311518036652	1	37,58	151
K1008M06	7311518036683	1	44,28	151
K1210M06	7311518036720	1	46,99	151
K1612M06	7311518193959	1	64,57	151
K1612M08	7311518036768	1	61,21	151
K172	7314150384396	1	33,64	180
K18NF-2	7314151347161	5	7,77	177
K18PH-2M5	7314153019646	5	8,62	177
K18PH-2M6	7314150274871	5	8,66	177
K19PZD-2M5	7314151693237	1	7,77	177
K19PZD-2NF	7314151586157	1	7,77	177
K20TORX-T25	7314151825799	10	10,98	177
K560F-1	7314151825492	5	3,34	180
K560F-2	7314151825324	5	3,34	181
K560F-3	7314151825331	5	3,34	181
K560F-4	7314151825348	5	3,56	184
K560F-5	7314151825355	5	3,56	184
K560F-6	7314151825362	5	4,05	187
K560F-7	7314151825379	5	4,57	189
K560F-8	7314151825508	5	5,99	189
K560F-9	7314151846688	5	7,09	191
K66100-1/4	7314150204540	1	55,90	179
K66100-1/4P-1P	7314150533244	20	11,19	179
K66100-3/8	7314150204564	1	70,75	179
K66100-3/8-1P	7314150260249	25	14,15	179
K6625-1/4B-1P	7314150533282	80	5,44	179
K6625-1/4B-5P	7314150533305	50	27,24	179
K6638-3/8	7314150204557	1	31,84	179
K6638-3/8-1P	7314150260164	25	6,38	179
K6650-1/2P-1P	7314150533343	20	14,85	179
K6650-1/2P-5P	7314150533367	25	74,30	179
K6650-1/4B-1P	7314150533381	20	9,00	179
K6650-1/4P-5P	7314150533404	50	44,92	179
K6650-3/8P-1P	7314150533428	20	12,03	179
K6650-3/8P-5P	7314150533442	25	60,15	179
K6660-QR-1P	7314150204571	1	14,57	179
K6701M-10	7314151778149	1	7,61	179
K6701M-11	7314151778224	1	7,61	179
K6701M-12	7314151811891	1	9,49	179
K6701M-13	7314151778491	1	9,49	179
K6701M-14	7314151844172	1	9,49	179
K6701M-6	7314151813260	1	7,57	179
K6701M-7	7314151777920	1	7,57	179
K6701M-8	7314151778064	1	7,61	179
K6701M-9	7314151815110	1	7,61	179
K6750-1/4	7314150204663	1	6,26	177
K6750-10-1P	7314150533466	20	6,26	177
K6750-13	7314150204823	1	6,26	177
K6750-3/8	7314150204656	1	6,26	177
K6750-6	7314150204670	1	6,26	177
K6750-7*	7314150204687	1	6,26	177
K6750-8-1P	7314150533541	20	6,26	177



K6964C	7314151215170	1	23,90	181
K7401M-10	7314151780128	1	8,96	180
K7401M-11	7314151780395	1	8,96	180
K7401M-12	7314151811907	1	8,96	180
K7401M-13	7314151780470	1	8,96	180
K7401M-14	7314151780555	1	8,96	180
K7401M-15	7314151812140	1	8,96	180
K7401M-16	7314151780630	1	8,96	180
K7401M-17	7314151780715	1	8,96	180
K7401M-18	7314151812157	1	10,65	180
K7401M-19	7314151812164	1	10,65	180
K7401M-20	7314151844271	1	10,95	180
K7401M-21	7314151845216	1	10,95	180
K7401M-22	7314151845223	1	11,45	180
K7401M-24	7314151844295	1	11,63	180
K7401M-7	7314151812126	1	8,96	180
K7401M-8	7314151780043	1	8,96	180
K7401M-9	7314151812133	1	8,96	180
K7401M10	7314150389919	1	89,05	181
K7401TORX-E-S7*	7314150343324	1	82,36	182
K7401TORX-E10*	7314151844448	1	11,76	181
K7401TORX-E12*	7314151844455	1	11,76	181
K7401TORX-E14*	7314151844462	1	11,76	181
K7401TORX-E5*	7314151844400	1	11,76	181
K7401TORX-E6*	7314151844417	1	11,76	181
K7401TORX-E7*	7314151844424	1	11,76	181
K7401TORX-E8*	7314151844431	1	11,76	181
K7401Z-1/2*	7314150384402	1	9,45	180
K7401Z-11/16*	7314150384419	1	9,45	180
K7401Z-13/16*	7314150384426	1	9,45	180
K7401Z-3/4*	7314150384433	1	9,45	180
K7401Z-3/8*	7314150384440	1	9,45	180
K7401Z-5/8*	7314150384457	1	9,45	180
K7401Z-7/16*	7314150384464	1	9,45	180
K7401Z-7/8*	7314150384471	1	9,45	180
K7401Z-9/16*	7314150384488	1	9,45	180
K7406M-10	7314151844479	1	10,02	180
K7406M-13	7314151844486	1	11,38	180
K7406M-17	7314151844493	1	12,41	180
K7760C-1	7314151222369	1	16,50	181
K7760C-2	7314151222376	1	23,72	181
K7764D	7314151222475	1	24,74	184
K7767S	7314151222512	1	34,90	181
K7800M-10	7314150326297	1	6,54	182
K7800M-11	7314150326303	1	6,54	182
K7800M-12	7314150326310	1	6,54	182
K7800M-13	7314150326327	1	6,54	182
K7800M-14	7314150326334	1	6,65	182
K7800M-15	7314150326341	1	6,65	182
K7800M-16	7314150326358	1	6,65	182
K7800M-17	7314150326365	1	6,95	182
K7800M-18	7314150326372	1	6,95	182
K7800M-19	7314150326389	1	6,95	182
K7800M-21	7314150326396	1	6,95	182
K7800M-22	7314150326402	1	7,07	182
K7800M-24	7314150326419	1	7,64	182
K7800M13	7314150437221	1	83,78	184
K7801M-10	7314151778576	1	10,60	182
K7801M-11	7314151778651	1	10,60	182
K7801M-12	7314151815790	1	10,60	182
K7801M-13	7314151778736	1	10,60	182
K7801M-14	7314151778811	1	10,97	182
K7801M-15	7314151815806	1	11,19	182
K7801M-16	7314151779030	1	11,19	182
K7801M-17	7314151779115	1	11,71	182
K7801M-18	7314151779382	1	11,71	182
K7801M-19	7314151779467	1	11,71	182
K7801M-20	7314151844509	1	12,35	182
K7801M-21	7314151779542	1	12,42	182
K7801M-22	7314151779627	1	12,57	182
K7801M-23	7314151844516	1	12,95	182
K7801M-24	7314151779894	1	13,14	182
K7801M-25	7314151844523	1	15,21	182
K7801M-26	7314151844530	1	15,64	182
K7801M-27	7314151779979	1	15,64	182
K7801M-28	7314150430154	1	15,64	182
K7801M-29	7314150430161	1	15,80	182
K7801M-30	7314151811914	1	19,16	182
K7801M-32	7314151825157	15	27,44	182
K7801M-34	7314151844547	1	30,99	182
K7801M-36	7314151844554	1	32,03	182
K7801M-8	7314151845230	1	6,26	182
K7801M-9	7314151845247	1	6,26	182
K7801TORX-E10	7314151811587	1	14,04	184
K7801TORX-E12	7314151811594	1	14,04	184
K7801TORX-E14	7314151811600	1	14,04	184
K7801TORX-E16	7314151811617	1	14,04	184
K7801TORX-E18	7314151811624	1	14,04	184
K7801TORX-E20	7314151811631	1	15,21	184
K7801TORX-E24	7314151811648	1	15,21	184
K7801Z-1	7314151844639	1	13,75	183
K7801Z-1.1/16	7314151844646	1	14,88	183
K7801Z-1.1/2	7314150137701	5	35,39	183
K7801Z-1.1/4	7314151844660	1	26,50	183
K7801Z-1.1/8	7314151844653	1	15,83	183
K7801Z-1.3/8	7314150137688	5	30,78	183

			€	
K7801Z-1.5/16	7314150137671	5	30,78	183
K7801Z-1.7/16	7314150137695	5	30,78	183
K7801Z-1/2	7314151822620	1	10,67	183
K7801Z-11/16	7314151844592	1	11,05	183
K7801Z-13/16	7314151844608	1	11,22	183
K7801Z-15/16	7314151844622	1	13,16	183
K7801Z-3/4	7314151822668	1	11,06	183
K7801Z-3/8	7314151822606	1	10,67	183
K7801Z-5/8	7314151844585	1	11,05	183
K7801Z-7/16	7314151844561	1	10,67	183
K7801Z-7/8	7314151844615	1	11,22	183
K7801Z-9/16	7314151822637	1	11,05	183
K7801Z/H0	7314150165018	1	116,84	185
K7806M-10	7314151844677	1	12,92	182
K7806M-11	7314151844684	1	12,92	182
K7806M-12	7314151844691	1	12,92	182
K7806M-13	7314151805944	1	12,92	182
K7806M-14	7314151844707	1	12,92	182
K7806M-15	7314150330683	1	13,06	182
K7806M-16	7314151844714	1	13,06	182
K7806M-17	7314151805951	1	13,06	182
K7806M-18	7314151844721	1	13,10	182
K7806M-19	7314151805968	1	13,10	182
K7806M-21	7314151823597	1	13,10	182
K7806M-22	7314151805975	1	13,10	182
K7806M-23	7314151844738	1	13,71	182
K7806M-24	7314151805982	1	13,52	182
K7806M-27	7314151805999	1	15,78	182
K7806M-30	7314151844578	1	17,84	182
K7806M-32	7314150220304	1	20,84	182
K7806M-33	7314150554386	1	22,15	182
K7806M-34	7314150554393	1	22,15	182
K7806M-36	7314150220311	1	24,12	182
K7806M/S4	7314151813222	1	52,78	184
K7806Z-1	7314150137817	5	16,24	183
K7806Z-1.1/16	7314150137824	5	17,35	183
K7806Z-1.1/2	7314150137886	5	40,53	183
K7806Z-1.1/4	7314150137848	5	30,36	183
K7806Z-1.1/8	7314150137831	5	19,63	183
K7806Z-1.3/8	7314150137862	5	35,27	183
K7806Z-1.5/16	7314150137855	5	35,27	183
K7806Z-1.7/16	7314150137879	5	35,27	183
K7806Z-1/2	7314150137749	10	14,19	183
K7806Z-11/16	7314150137770	5	14,36	183
K7806Z-13/16	7314150137794	5	14,40	183
K7806Z-15/16	7314150137718	5	14,86	183
K7806Z-3/4	7314150137787	5	14,40	183
K7806Z-3/8	7314150137725	10	14,19	183
K7806Z-5/8	7314150137763	5	14,36	183
K7806Z-7/16	7314150137732	5	14,19	183
K7806Z-7/8	7314150137800	5	14,40	183
K7806Z-9/16	7314150137756	10	14,19	183
K7806Z/H0	7314150165025	1	145,61	185
K8160D-1	7314151237400	1	14,52	184
K8160D-2	7314151237417	1	17,88	184
K8160D-3	7314151237424	1	28,34	184
K8164C	7314151237523	1	23,90	181
K8164F	7314151237554	1	34,69	187
K8167S	7314151237592	1	35,68	184
K8901M-17	7314151803155	1	23,87	186
K8901M-18	7314151844189	1	23,84	186
K8901M-19	7314151803162	1	23,87	186
K8901M-21	7314151803179	1	23,96	186
K8901M-22	7314151803186	1	23,96	186
K8901M-23	7314151803193	1	23,96	186
K8901M-24	7314151803209	1	24,87	186
K8901M-27	7314151803216	1	26,25	186
K8901M-28	7314151803223	1	27,46	186
K8901M-29	7314151803230	1	30,78	186
K8901M-30	7314151803247	1	33,64	186
K8901M-32	7314151803254	1	33,54	186
K8901M-33	7314151803261	1	34,39	186
K8901M-34	7314151803278	1	34,36	186
K8901M-36	7314151803285	1	36,24	186
K8901M-38	7314151803292	1	37,83	186
K8901M-41	7314151803308	1	44,98	186
K8901M-46	7314151803315	1	45,68	186
K8901M-50	7314151846398	1	74,85	186
K8901M-55	7314151846404	1	90,21	186
K8901M-60	7314151846411	1	105,88	186
K8901M/8	7314150165032	1	245,23	187
K8901Z-1	7314151844752	1	29,94	186
K8901Z-1.1/16	7314151844769	1	29,94	186
K8901Z-1.1/2	7314151844820	1	40,36	186
K8901Z-1.1/4	7314151844783	1	30,66	186
K8901Z-1.1/8	7314151844776	1	29,94	186
K8901Z-1.11/16	7314150130269	1	48,31	186
K8901Z-1.13/16	7314150130276	1	47,74	186
K8901Z-1.15/16	7314150130290	1	67,76	186
K8901Z-1.3/16	7314150130245	1	29,94	186
K8901Z-1.3/4	7314151844844	1	52,95	186
K8901Z-1.3/8	7314151844806	1	31,48	186
K8901Z-1.5/16	7314151844790	1	30,66	186
K8901Z-1.5/8	7314151844837	1	44,50	186
K8901Z-1.7/16	7314151844813	1	31,48	186
K8901Z-1.7/8	7314150130283	1	61,30	186

\* Hasta agotar existencias

			€	
K8901Z-1.9/16	7314150130252	1	37,84	186
K8901Z-11/16	7314150130238	1	28,62	186
K8901Z-13/16	7314151844226	1	28,62	186
K8901Z-15/16	7314151844745	1	28,62	186
K8901Z-2	7314150130306	1	67,76	186
K8901Z-2.1/16	7314150130313	1	76,81	186
K8901Z-2.1/4	7314150130344	1	89,21	186
K8901Z-2.3/16	7314150130337	1	85,08	186
K8901Z-2.3/8	7314150130351	1	95,86	186
K8901Z-3/4	7314151844202	1	28,62	186
K8901Z-7/8	7314151844301	1	28,62	186
K8901Z/18	7314150436514	1	532,05	188
K8901Z/8	7314150165049	1	254,50	188
K8906M-17	7314151803056	1	44,01	186
K8906M-19	7314151803063	1	45,02	186
K8906M-21	7314151844851	1	45,76	186
K8906M-22	7314151803070	1	45,76	186
K8906M-24	7314151803087	1	46,49	186
K8906M-27	7314151803094	1	48,25	186
K8906M-30	7314151803117	1	49,26	186
K8906M-32	7314151803124	1	52,47	186
K8906M-33	7314151844868	1	53,22	186
K8906M-34	7314151844875	1	56,05	186
K8906M-36	7314151803148	1	57,99	186
K8906M-41	7314151845254	1	60,49	186
K8906M-42	7314150512607	1	43,97	186
K8906M-46	7314150220601	1	69,61	186
K8906M/8	7314150165056	1	381,39	187
K8906Z-1	7314150130436	1	48,09	186
K8906Z-1.1/16	7314150130443	1	48,09	186
K8906Z-1.1/2	7314150130511	1	59,46	186
K8906Z-1.1/4	7314150130474	1	50,01	186
K8906Z-1.1/8	7314150130450	1	48,09	186
K8906Z-1.3/4	7314150130559	1	72,04	186
K8906Z-1.3/8	7314150130498	1	57,68	186
K8906Z-1.5/16	7314150130481	1	57,13	186
K8906Z-1.5/8	7314150130535	1	59,46	186
K8906Z-1.7/16	7314150130504	1	57,68	186
K8906Z-13/16	7314150130405	1	48,09	186
K8906Z-15/16	7314150130429	1	48,09	186
K8906Z-2	7314150130580	1	108,82	186
K8906Z-3/4	7314150130399	1	48,09	186
K8906Z-7/8	7314150130412	1	48,09	186
K8906Z/8	7314150165063	1	426,21	188
K8909H-5	7314151619343	1	62,78	187
K8909ML-12	7314151232863	1	18,84	189
K8909ML-14	7314151232870	1	18,84	189
K8909ML-17	7314151232887	1	18,84	189
K8960F-2	7314151268138	1	47,32	187
K8960F-3	7314151268145	1	56,80	187
K8960F-4	7314150220625	1	61,55	187
K8964D	7314151268237	1	17,09	184
K8964G	7314151268268	1	36,82	189
K8967S	7314151268329	1	94,78	187
K9501M-22	7314151844882	1	44,67	188
K9501M-24	7314151802677	1	44,67	188
K9501M-27	7314151802684	1	46,07	188
K9501M-30	7314151802714	1	47,34	188
K9501M-32	7314151802721	1	49,71	188
K9501M-33	7314151802738	1	51,13	188
K9501M-34	7314151802745	1	52,72	188
K9501M-36	7314151802752	1	52,72	188
K9501M-38	7314151802769	1	53,13	188
K9501M-41	7314151802776	1	59,86	188
K9501M-42	7314151802783	1	70,52	188
K9501M-46	7314151802790	1	73,62	188
K9501M-50	7314151802806	1	82,05	188
K9501M-55	7314151802813	1	93,94	188
K9501M-60	7314151802820	1	114,42	188
K9501M-65	7314151802837	1	136,92	188
K9501M-70	7314151802844	1	156,12	188
K9501M-75	7314151802851	1	163,24	188
K9501M-80	7314151802868	1	171,83	188
K9501M-85	7314150352197	1	269,84	188
K9501Z-1	7314151844912	1	45,13	188
K9501Z-1.1/16	7314150130634	1	45,13	188
K9501Z-1.1/2	7314151844943	1	57,59	188
K9501Z-1.1/4	7314151844929	1	45,13	188
K9501Z-1.1/8	7314150130641	1	45,13	188
K9501Z-1.11/16	7314150130696	1	70,85	188
K9501Z-1.13/16	7314151844967	1	77,10	188
K9501Z-1.15/16	7314150130719	1	79,86	188
K9501Z-1.3/16	7314150130658	1	45,13	188
K9501Z-1.3/4	7314150130702	1	70,85	188
K9501Z-1.3/8	7314150130672	1	56,20	188
K9501Z-1.5/16	7314150130665	1	50,20	188
K9501Z-1.5/8	7314151844950	1	61,61	188
K9501Z-1.7/16	7314151844936	1	56,20	188
K9501Z-1.7/8	7314151844974	1	77,10	188
K9501Z-1.9/16	7314150130689	1	57,59	188
K9501Z-2	7314150130726	1	90,33	188
K9501Z-2.1/4	7314150130764	1	110,26	188
K9501Z-2.1/8	7314150130740	1	101,50	188
K9501Z-2.3/16	7314150130757	1	101,50	188
K9501Z-2.3/4	7314150130832	1	159,72	188
K9501Z-2.5/16	7314150130771	1	110,26	188



# K9501Z-2.9/16



K9501Z-2.9/16	7314150130801	1	152,07	188
K9506M-22	7314151844998	1	74,26	188
K9506M-24	7314151802530	1	74,26	188
K9506M-27	7314151802547	1	74,26	188
K9506M-30	7314151802554	1	74,99	188
K9506M-32	7314151802561	1	77,07	188
K9506M-33	7314151802578	1	78,13	188
K9506M-34	7314151845018	1	80,20	188
K9506M-36	7314151802585	1	80,20	188
K9506M-38	7314151802592	1	81,71	188
K9506M-41	7314151802608	1	90,20	188
K9506M-46	7314151802615	1	98,11	188
K9506M-50	7314151802622	1	119,24	188
K9506M-55	7314151802639	1	145,19	188
K9506M-60	7314151802646	1	177,43	188
K9506Z-1	7314150131686	1	66,44	189
K9506Z-1.1/16	7314150131693	1	67,49	189
K9506Z-1.1/2	7314150131761	1	69,97	189
K9506Z-1.1/4	7314150131723	1	67,70	189
K9506Z-1.13/16	7314150131808	1	96,94	189
K9506Z-1.3/16	7314150131716	1	67,49	189
K9506Z-1.5/8	7314150131785	1	75,62	189
K9506Z-1.7/16	7314150131754	1	67,70	189
K9506Z-1.7/8	7314150131815	1	109,33	189
K9509H5	7314151619428	1	100,07	189
K9509ML-19	7314151618964	1	19,33	189
K9509ML-22	7314151619183	1	25,35	189
K9509ML-24	7314151619268	1	25,42	189
K9560G-0	7314150240012	1	57,13	189
K9560G-1	7314151285944	1	62,39	189
K9560G-2	7314151285951	1	68,25	189
K9560G-3	7314151285968	1	64,01	189
K9560G-4	7314150133970	1	68,48	189
K9560G-5	7314150133987	1	83,70	189
K9564F	7314151286026	1	38,46	187
K9567S	7314151286095	1	199,11	189
K9598H	7314150133956	1	282,48	191
K9801M-100	7314151845162	1	554,50	190
K9801M-105	7314151845179	1	600,36	190
K9801M-110	7314151845186	1	758,27	190
K9801M-115	7314151845193	1	799,71	190
K9801M-120	7314151845209	1	860,96	190
K9801M-125	7314150167159	1	888,71	190
K9801M-130	7314150167166	1	987,46	190
K9801M-135	7314150167173	1	1.086,20	190
K9801M-140	7314150167180	1	1.135,58	190
K9801M-145	7314150167197	1	1.250,78	190
K9801M-150	7314150167203	1	1.481,21	190
K9801M-155	7314150167210	1	1.678,68	190
K9801M-46	7314151845056	1	208,42	190
K9801M-50	7314151845063	1	208,42	190
K9801M-55	7314151845070	1	220,73	190
K9801M-60	7314151845087	1	245,11	190
K9801M-65	7314151845094	1	266,63	190
K9801M-70	7314151845100	1	287,95	190
K9801M-75	7314151845117	1	312,42	190
K9801M-80	7314151845124	1	342,97	190
K9801M-85	7314151845131	1	394,08	190
K9801M-90	7314151845148	1	436,95	190
K9801M-95	7314151845155	1	516,34	190
K9801Z-1.1/2	7314150131976	1	132,22	190
K9801Z-1.11/16	7314150132003	1	135,09	190
K9801Z-1.13/16	7314150132027	1	142,27	190
K9801Z-1.15/16	7314150132041	1	142,27	190
K9801Z-1.3/4	7314150132010	1	142,27	190
K9801Z-1.3/8	7314150131952	1	132,63	190
K9801Z-1.5/8	7314150131990	1	135,09	190
K9801Z-1.7/16	7314150131969	1	132,22	190
K9801Z-1.7/8	7314150132034	1	142,27	190
K9801Z-1.9/16	7314150131983	1	136,44	190
K9801Z-2	7314150132058	1	142,27	190
K9801Z-2.1/16	7314150132065	1	143,66	190
K9801Z-2.1/2	7314150132133	1	196,22	190
K9801Z-2.1/4	7314150132096	1	164,16	190
K9801Z-2.1/8	7314150132072	1	145,41	190
K9801Z-2.11/16	7314150132164	1	226,66	190
K9801Z-2.13/16	7314150132188	1	213,66	190
K9801Z-2.15/16	7314150132201	1	288,45	190
K9801Z-2.3/16	7314150132089	1	147,83	190
K9801Z-2.3/4	7314150132171	1	248,07	190
K9801Z-2.3/8	7314150132119	1	195,03	190
K9801Z-2.5/16	7314150132102	1	177,65	190
K9801Z-2.5/8	7314150132157	1	212,50	190
K9801Z-2.7/16	7314150132126	1	196,97	190
K9801Z-2.7/8	7314150132195	1	270,62	190
K9801Z-2.9/16	7314150132140	1	205,20	190
K9801Z-3	7314150132218	1	303,17	190
K9801Z-3.1/16	7314150132225	1	330,36	190
K9801Z-3.1/2	7314150132287	1	382,73	190
K9801Z-3.1/4	7314150132249	1	343,86	190
K9801Z-3.1/8	7314150132232	1	347,03	190
K9801Z-3.11/16	7314150132317	1	588,29	190
K9801Z-3.13/16	7314150132331	1	572,18	190
K9801Z-3.15/16	7314150132355	1	675,80	190
K9801Z-3.3/4	7314150132324	1	575,21	190
K9801Z-3.3/8	7314150132263	1	367,17	190



K9801Z-3.5/16	7314150132256	1	353,57	190
K9801Z-3.5/8	7314150132300	1	502,41	190
K9801Z-3.7/16	7314150132270	1	378,97	190
K9801Z-3.7/8	7314150132348	1	675,04	190
K9801Z-3.9/16	7314150132294	1	429,43	190
K9801Z-4	7314150132362	1	684,94	190
K9801Z-4.1/16	7314150132379	1	692,94	190
K9801Z-4.1/2	7314150132430	1	869,25	190
K9801Z-4.1/4	7314150132393	1	735,53	190
K9801Z-4.1/8	7314150132386	1	719,37	190
K9801Z-4.3/4	7314150132454	1	1.065,32	190
K9801Z-4.3/8	7314150132416	1	830,05	190
K9801Z-4.5/16	7314150132409	1	783,07	190
K9801Z-4.5/8	7314150132447	1	889,20	190
K9801Z-4.7/16	7314150132423	1	849,22	190
K9806M-100	7314150131105	1	1.002,59	190
K9806M-105	7314150131112	1	1.102,01	190
K9806M-110	7314150131129	1	1.406,98	190
K9806M-115	7314150131136	1	1.567,09	190
K9806M-120	7314150131143	1	3.009,47	190
K9806M-41	7314150130986	1	425,81	190
K9806M-46	7314150130993	1	425,81	190
K9806M-50	7314150131006	1	425,81	190
K9806M-55	7314150131013	1	425,81	190
K9806M-60	7314150131020	1	436,07	190
K9806M-65	7314150131037	1	483,62	190
K9806M-70	7314150131044	1	543,76	190
K9806M-75	7314150131051	1	608,13	190
K9806M-80	7314150131068	1	735,52	190
K9806M-85	7314150131075	1	740,10	190
K9806M-90	7314150131082	1	781,52	190
K9806M-95	7314150131099	1	920,02	190
K9806Z-1.1/2	7314150131174	1	197,55	190
K9806Z-1.11/16	7314150131198	1	199,49	190
K9806Z-1.3/8	7314150131150	1	198,00	190
K9806Z-1.5/8	7314150131181	1	199,49	190
K9806Z-1.7/16	7314150131167	1	199,49	190
K9806Z-2	7314150131204	1	209,13	190
K9806Z-2.1/16	7314150131211	1	209,13	190
K9806Z-2.1/2	7314150131273	1	294,53	190
K9806Z-2.1/4	7314150131235	1	235,55	190
K9806Z-2.11/16	7314150131303	1	364,14	190
K9806Z-2.13/16	7314150131327	1	397,35	190
K9806Z-2.15/16	7314150131341	1	425,05	190
K9806Z-2.3/16	7314150131228	1	226,54	190
K9806Z-2.3/4	7314150131310	1	380,12	190
K9806Z-2.3/8	7314150131259	1	289,27	190
K9806Z-2.5/16	7314150131242	1	240,62	190
K9806Z-2.5/8	7314150131297	1	357,95	190
K9806Z-2.7/16	7314150131266	1	290,42	190
K9806Z-2.7/8	7314150131334	1	419,77	190
K9806Z-2.9/16	7314150131280	1	296,19	190
K9806Z-3	7314150131358	1	457,19	190
K9806Z-3.1/16	7314150131365	1	480,97	190
K9806Z-3.1/2	7314150131433	1	586,60	190
K9806Z-3.1/4	7314150131396	1	541,88	190
K9806Z-3.1/8	7314150131372	1	505,37	190
K9806Z-3.11/16	7314150131464	1	781,90	190
K9806Z-3.13/16	7314150131488	1	781,90	190
K9806Z-3.15/16	7314150131501	1	844,31	190
K9806Z-3.3/16	7314150131389	1	514,03	190
K9806Z-3.3/4	7314150131471	1	804,18	190
K9806Z-3.3/8	7314150131419	1	562,71	190
K9806Z-3.5/16	7314150131402	1	541,92	190
K9806Z-3.5/8	7314150131457	1	616,64	190
K9806Z-3.7/16	7314150131426	1	586,60	190
K9806Z-3.7/8	7314150131495	1	866,50	190
K9806Z-3.9/16	7314150131440	1	626,15	190
K9806Z-4	7314150131518	1	853,41	190
K9806Z-4.1/16	7314150131525	1	832,58	190
K9806Z-4.1/2	7314150131570	1	1.339,34	190
K9806Z-4.1/4	7314150131549	1	1.079,23	190
K9806Z-4.1/8	7314150131532	1	1.044,61	190
K9806Z-4.3/4	7314150131594	1	1.464,69	190
K9806Z-4.3/8	7314150131563	1	1.294,00	190
K9806Z-4.5/16	7314150131556	1	1.200,02	190
K9806Z-4.5/8	7314150131587	1	1.372,64	190
K9860H-1	7314150133994	1	429,36	191
K9860H-2	7314150134007	1	473,61	191
K9860H-3	7314150134014	1	477,78	191
K9867S	7314150133932	1	674,06	191
K9895G	7314150133949	1	180,79	189
K9899H	7314150166763	1	1.259,01	191
K9998H	7314150133963	1	960,26	191
KB09-01	7314150196968	5	8,84	568
KB18-01	7314150196944	5	11,20	568
KBFU-01	7314150196913	5	16,70	567
KBGH-5P-DISPEN	7314150296729	20	3,52	568
KBGR-5P-DISPEN	7314150296774	20	4,83	568
KBGU-100P	7314150213405	1	33,58	567
KBGU-10P-DISPEN	7314150262984	20	5,20	567
KBGU-5P-DISPEN	7314150296705	20	3,02	567
KBRU-01	7314150196876	5	18,55	566
KBSK-01	7314150196999	5	20,61	569
KBSU-01	7314150197002	5	20,61	569
KBTU-01	7314150196982	5	32,38	569





KBWS-01	7314150225972	10	6,20	572
KCB753	7314150204915	1	47,54	178
KE18-01	7314150196937	5	16,48	566
KFU-U01	7314150196906	5	19,33	566
KERU-01	7314150196869	5	21,50	566
KEYRING	7314150500864	50	10,08	424
KG09-01	7314150196975	5	6,33	568
KG09-01-3P	7314150213962	10	18,99	568
KG18-01	7314150196951	5	8,23	568
KGAU-01	7314150223893	5	16,89	569
KGFU-01	7314150196920	5	11,92	567
KGRU-01	7314150196683	5	13,24	567
KGRU-02	7314150196890	5	11,77	567
KGSU-01	7314150197019	5	15,89	569
KHU-01	7314150268955	4	4,96	569
KM1/4-5/16-1P	7314150275953	50	6,99	179
KM653-1P	7314151840709	25	6,18	178
KM653-5P	7314150533565	25	30,92	178
KM653-QR-1P	7314151848507	50	15,77	177
KM653-QR-5P	7314150533589	25	67,93	177
KM653-SF	7314150204984	1	18,41	178
KM6701M-10	7314151844264	1	33,95	180
KM6701M-7	7314151844240	1	32,51	180
KM6701M-8	7314151844257	1	32,91	180
KM6750-1/4	7314150204595	1	7,63	177
KM6750-10-1P	7314150533626	20	7,63	177
KM6750-11-1P	7314150533640	20	7,63	177
KM6750-13-1P	7314150533664	20	7,63	177
KM6750-3/8	7314150204588	1	7,63	177
KM6750-6	7314150204601	1	7,63	177
KM6750-7-1P	7314150533725	20	7,63	177
KM6750-8-1P	7314150533749	20	7,63	177
KM753-QR-1P*	7314150204830	1	17,69	178
KMR150-1P	7314150204977	1	16,26	178
KMR653-1P	7314150204939	1	9,26	178
KMR653-5P	7314150533763	50	26,71	178
KMR753	7314150204946	1	42,46	178
KMR753-1P	7314150204953	1	8,48	178
KMT753-QR-1P	7314150391523	50	10,54	178
KMU-01	7314150197026	5	8,84	567
KR653	7314150204885	1	30,07	178
KR653-1P	7314150260263	25	6,02	178
KRSS-01	7314150214938	10	6,91	572
KS7401M-10*	7314150384495	1	34,55	181
KS7401M-11*	7314150384501	1	34,55	181
KS7401M-12*	7314150384518	1	34,55	181
KS7401M-13*	7314150384525	1	34,55	181
KS7401M-14*	7314150384532	1	35,71	181
KS7401M-15*	7314150384549	1	35,71	181
KS7401M-16*	7314150384556	1	35,71	181
KS7401M-17*	7314150384563	1	35,71	181
KS7401M-18*	7314150384570	1	35,71	181
KS7401M-19*	7314150384587	1	35,71	181
KS7401M-22*	7314150384594	1	38,54	181
KS7401M-9*	7314150384600	1	34,55	181
KSBG09-10DISPEN	7314150262991	20	4,64	568
KSBG18-10DISPEN	7314150263004	20	6,06	568
KSR753-1P*	7314150204908	1	22,58	517
KUBG09-5P*	7314150213450	20	3,14	568
KUBG18-5DISPEN	7314150296835	20	4,32	568
L1020I06	7314150501649	5	41,53	153
L1020M06	7311518133665	1	59,97	151
L1020M06X	7311518136369	1	62,97	151
L1020S06	7314150501670	5	38,09	152
L1225M06	7311518132774	1	66,67	151
L1225M06X	7311518136857	1	73,80	151
L1228I06	7314150501700	5	50,74	153
L1228S06	7314150501731	5	46,50	152
L1230AL06	7311518187668	1	90,39	152
L1230AL08	7311518181871	1	90,39	152
L1230M06	7311518182168	1	75,42	151
L1230M06X	7311518182175	1	74,98	151
L1630M06	7311518192914	1	78,89	151
L1630M06X	7311518187446	1	82,79	151
L1630M08	7311518182205	1	78,89	151
L1630M08X	7311518136833	1	82,79	151
LAP-KNIFE	7311518216443	10	42,75	621
LARGE	7314150437429	1	2.731,82	369
LS-6160-23	7311518041304	90	9,21	622
LS-COIN 19 CM	7311518031077	4	30,19	587
LS-COIN 26 CM	7311518333041	2	32,43	587
LS-COMBINESS	7311518041366	600	13,33	622
LS-MASSE-4	7311518012014	2	47,94	586
LS-MASSE-4FG	7311518275891	2	59,18	586
LS-MASSE-TR-4FG	7311518281106	2	65,08	587
LS-MERLIN-2.5	7311518012069	2	50,79	587
LS-MERLIN-2.5FG	7311518281113	2	65,56	587
LS-PIERRE CORINDON	7311518009977	1	15,89	622
LS-PIERRE-FAUX	7311518009038	90	16,88	622
LT-STEEL-30	7314150138012	5	69,33	527
LT-STEEL-50	7314150138029	5	108,54	527
LTB-10	7314150120048	6	20,54	527
LTB-20	7314150120062	6	23,30	527
LTB-30	7314150120086	6	30,12	527
LTG-10	7314150119981	6	17,20	527
LTG-20	7314150120000	6	23,05	527

\* Hasta agotar existencias



LTG-30	7314150120024	6	27,63	527
LTS-100	7314150120147	5	84,65	527
LTS-100-E	7314150120154	5	84,65	527
LTS-30	7314150120109	5	29,12	527
LTS-30-E	7314150120116	5	29,12	527
LTS-50	7314150120123	5	40,13	527
LTS-50-E	7314150120130	5	40,13	527
LUB-2015	7311518335427	6	20,56	622
M0310M03	7311518036805	1	20,37	151
M0310M03X	7311518197063	1	20,35	151
M0613M03X	7311518196622	1	31,16	151
M0618M06	7311518036836	1	35,71	151
M0618M06X	7311518036850	1	35,51	151
M1022M06	7311518036881	1	43,17	151
M1022M06X	7311518036904	1	42,99	151
M1227M06	7311518036928	1	55,43	151
M1227M06X	7311518036959	1	55,24	151
M1227M08	7311518036980	1	55,32	151
M1630M06	7311518193010	1	91,58	151
M1630M06X	7311518187453	1	91,17	151
M1630M08	7311518037062	1	91,58	151
M1630M08X	7311518037086	1	91,17	151
M227L	7311518160883	4	38,03	565
M227R	7311518160869	4	38,03	565
M330	7311518160906	4	74,17	565
M526	7311518160982	4	38,44	565
M6376-SH	7311518199296	1	129,44	565
M676-SH*	7311518211875	1	129,20	565
M780	7314151826215	1	21,03	226
M781	7314153016218	5	13,30	226
MA225R	7311518161040	4	52,54	564
MA311	7314150181568	1	39,82	564
MA321	7314150181551	10	39,82	564
MA351	7314150181582	10	44,60	564
MA361	7314150181575	10	44,60	564
MA401	7314150167593	10	30,50	564
MA411	7314150167609	10	30,50	564
MA421	7314150167616	10	30,50	564
MA431	7314150181544	1	33,45	564
MA500-1A	7314150458882	1	281,46	637
MA500-2A	7314150458899	1	287,99	637
MA500-3A	7314150456925	1	294,31	637
MAM50M	7314150215300	1	256,22	121
MCP-2.5-810	7311518124052	2	75,60	586
MES-3.0-900	7311518123864	2	55,39	587
MES-3.5-900	7311518123871	2	61,78	587
MES-3.5-900FG	7311518281120	2	79,39	587
MK5	7314150224333	1	28,30	61
MK9	7314150224326	25	43,15	62
MONSTER	7314150437405	1	8.497,05	369
MR227L	7311518161002	4	47,34	565
MT-TS-3	7314150194995	12	10,15	526
MTB-3-16	7314150119066	6	12,11	526
MTB-3-16-M	7314150119073	6	13,81	526
MTB-3-16-M-E	7314150119141	6	13,81	526
MTB-5-25	7314150119080	6	24,75	526
MTB-5-25-C1	7314150119127	6	36,66	526
MTB-5-25-M	7314150119097	6	26,48	526
MTB-5-25-M-E	7314150119158	6	26,48	526
MTB-8-25	7314150125418	6	37,68	526
MTB-8-25-M	7314150127078	6	40,18	526
MTB-8-25-M-E	7314150127085	6	40,18	526
MTC-3-13	7314150321322	6	8,39	526
MTC-3-13-C1	7314150330843	6	11,68	526
MTC-5-16	7314150321339	6	10,23	526
MTC-5-16-C1	7314150330850	6	13,09	526
MTG-3-16	7314150118984	12	5,42	526
MTG-3-16-E	7314150119028	12	5,42	526
MTG-5-19	7314150118991	12	8,53	526
MTG-5-19-E	7314150119035	12	8,53	526
MTG-8-25	7314150330348	4	10,85	526
MTG-8-25-E	7314150390809	4	10,85	526
MTS-5-25	7314150119233	6	33,46	526
MTS-5-25-E	7314150119271	6	33,46	526
MTS-8-25	7314150119257	6	41,33	526
MTS-8-25-E	7314150119295	6	41,33	526
MTT051	7314150270521	6	25,88	572
MTT121	7314150213290	8	21,13	572
MTT151	7314150120703	6	43,36	572
MW-150	7314150125685	2	78,34	527
MW-250	7314150125678	2	140,52	527
N0306M03	7311518182212	1	19,60	151
N0306M03E	7311518182229	1	21,43	151
N0607M06	7311518182236	1	30,60	151
N1213M06	7311518134570	1	48,89	151
N1213M06X	7311518237172	1	48,68	151
N1613M06	7311518136000	1	63,88	151
N1613M06X	7311518204525	1	63,60	151
N1613M08	7311518182267	1	63,88	151
NP-12-COM	7311518264277	4	15,87	548
NP-12-TEN	7311518263959	10	18,63	552
NP-12-VEN	7311518264260	10	19,49	552
NP-16-U7/8-HP	7311518241773	4	14,96	549
NP-19-U7/8-HP	7311518241452	10	14,96	549
NP-22-F7/8-HP	7311518035204	10	16,30	550
NP-22-U7/8-HP	7311518034399	10	15,98	549





# NS001-150



NS001-150	7314150316069	5	107,67	494
NS001-200	7314150316076	5	123,25	494
NS001-250	7314150316083	5	165,74	494
NS001-300	7314150316090	5	211,09	494
NS001-375	7314150325108	5	325,82	494
NS001-450	7314150325115	3	453,33	494
NS001-600	7314150325122	1	736,67	494
NS001-900	7314150325139	1	1.656,29	494
NS002-10	7314150284719	10	36,69	494
NS002-11	7314150292592	5	45,99	494
NS002-12	7314150292608	5	45,99	494
NS002-13	7314150284726	10	45,99	494
NS002-14	7314150284733	5	48,71	494
NS002-15	7314150292615	5	51,42	494
NS002-16	7314150292622	5	54,13	494
NS002-17	7314150284740	10	67,64	494
NS002-18	7314150292639	5	70,35	494
NS002-19	7314150284757	10	73,05	494
NS002-20	7314150292646	5	75,77	494
NS002-21	7314150292653	5	78,47	494
NS002-22	7314150292660	10	81,16	494
NS002-23	7314150292677	5	86,59	494
NS002-24	7314150292684	10	92,01	494
NS002-25	7314150292691	5	94,70	494
NS002-26	7314150292707	5	108,24	494
NS002-27	7314150284764	5	108,24	494
NS002-28	7314150292714	5	117,02	494
NS002-29	7314150292721	10	119,74	494
NS002-30	7314150292738	10	128,51	494
NS002-31	7314150292745	5	135,30	494
NS002-32	7314150284771	5	142,05	494
NS002-33	7314150292752	5	154,97	494
NS002-34	7314150292769	5	158,81	494
NS002-35	7314150292776	5	162,35	494
NS002-36	7314150284788	5	169,12	494
NS002-38	7314150292783	5	175,87	494
NS002-40	7314150292790	5	189,41	494
NS002-41	7314150292806	5	216,45	494
NS002-42	7314150292813	5	230,00	494
NS002-46	7314150292820	5	243,53	494
NS002-50	7314150292837	5	311,16	494
NS002-52	7314150292844	5	313,89	494
NS002-55	7314150292851	5	318,33	494
NS002-6	7314150292554	5	36,02	494
NS002-60	7314150292868	1	353,79	494
NS002-65	7314150292875	1	449,05	494
NS002-7	7314150292561	5	40,83	494
NS002-70*	7314150292882	1	517,10	494
NS002-75	7314150292899	1	598,73	494
NS002-8	7314150292578	5	40,83	494
NS002-80*	7314150292905	1	707,59	494
NS002-9	7314150292585	5	42,19	494
NS003-11*	7314150306602	1	38,64	494
NS003-12*	7314150306619	1	39,79	494
NS003-14*	7314150306626	1	41,82	494
NS003-16	7314150306633	1	46,93	494
NS003-18	7314150320356	1	51,01	494
NS003-20*	7314150320363	1	55,72	494
NS003-24*	7314150320370	1	70,79	494
NS003-28	7314150320387	1	79,06	494
NS003-30	7314150320394	1	98,29	494
NS003-8*	7314150320349	1	33,46	494
NS006-0607	7314150292912	1	18,52	495
NS006-0608	7314150292929	1	18,86	495
NS006-0708	7314150292936	1	18,53	495
NS006-0709	7314150292943	1	18,84	495
NS006-0809	7314150292967	1	18,53	495
NS006-0810	7314150292950	1	19,61	495
NS006-0910*	7314150292974	1	19,95	495
NS006-0911	7314150292981	1	23,98	495
NS006-1011	7314150292998	1	23,27	495
NS006-1012	7314150293001	1	26,15	495
NS006-1013	7314150293018	1	26,59	495
NS006-1014*	7314150293025	1	26,81	495
NS006-1113	7314150293032	1	30,52	495
NS006-1114	7314150293049	1	31,02	495
NS006-1213	7314150293056	1	29,09	495
NS006-1214	7314150293063	1	39,73	495
NS006-1315	7314150293070	1	43,59	495
NS006-1415	7314150293087	1	34,91	495
NS006-1416	7314150293094	1	43,59	495
NS006-1417	7314150293100	1	34,91	495
NS006-1617	7314150293117	1	37,80	495
NS006-1618	7314150293124	1	37,80	495
NS006-1719	7314150293131	1	37,80	495
NS006-1722*	7314150293148	1	43,63	495
NS006-1819	7314150293155	1	43,63	495
NS006-1820*	7314150293162	1	46,35	495
NS006-1920	7314150293179	1	46,54	495
NS006-1922	7314150293186	1	52,35	495
NS006-1924	7314150293193	1	52,35	495
NS006-2022	7314150293209	1	52,35	495
NS006-2122	7314150293216	1	52,79	495
NS006-2123	7314150293223	1	55,25	495
NS006-2223	7314150293230	1	58,17	495
NS006-2224	7314150293247	1	58,65	495



NS006-2227	7314150293254	1	65,44	495
NS006-2326	7314150293261	1	66,57	495
NS006-2425	7314150293278	1	71,48	495
NS006-2426	7314150293285	1	72,72	495
NS006-2427	7314150293292	1	51,42	495
NS006-2430	7314150293308	1	58,13	495
NS006-2528	7314150293315	1	54,13	495
NS006-2629*	7314150293322	1	55,53	495
NS006-2729	7314150293339	1	62,23	495
NS006-2730	7314150293346	1	77,61	495
NS006-2732	7314150293353	1	86,93	495
NS006-2830	7314150293360	1	86,93	495
NS006-3031	7314150293377	1	90,03	495
NS006-3032	7314150293384	1	109,06	495
NS006-3034*	7314150293391	1	95,61	495
NS006-3036	7314150293407	1	95,61	495
NS006-3234	7314150293414	1	95,61	495
NS006-3235	7314150293421	1	95,61	495
NS006-3236	7314150293438	1	138,13	495
NS006-3335	7314150293445	1	145,36	495
NS006-3436	7314150293452	1	145,36	495
NS006-3536	7314150293469	1	145,36	495
NS006-3638	7314150293476	1	212,39	495
NS006-3641	7314150293483	1	212,39	495
NS006-3642	7314150293490	1	235,98	495
NS006-4146	7314150293506	1	218,12	495
NS006-4650	7314150293513	1	306,79	495
NS006-5052*	7314150293520	1	311,50	495
NS006-5055	7314150293537	1	316,22	495
NS006-5060*	7314150293544	1	320,94	495
NS006-5062*	7314150293551	1	436,24	495
NS006-5560	7314150293568	1	465,31	495
NS006-6065	7314150293575	1	567,11	495
NS006-6570*	7314150293582	1	581,65	495
NS010-0607*	7314150293599	1	36,51	496
NS010-0709*	7314150293605	1	36,51	496
NS010-0809	7314150293612	1	38,75	496
NS010-0911*	7314150293629	1	40,99	496
NS010-1011	7314150293636	1	40,99	496
NS010-1012	7314150293643	1	42,58	496
NS010-1214	7314150293650	1	44,20	496
NS010-1315	7314150293667	1	52,52	496
NS010-1417	7314150293674	1	52,52	496
NS010-1618	7314150293681	1	69,80	496
NS010-1719	7314150293698	1	76,85	496
NS010-1722*	7314150293704	1	84,53	496
NS010-1819	7314150293711	1	76,85	496
NS010-1921	7314150293728	1	93,49	496
NS010-1922	7314150293735	1	95,72	496
NS010-2022	7314150293742	1	97,97	496
NS010-2123*	7314150293759	1	105,67	496
NS010-2224	7314150293766	1	115,27	496
NS010-2427	7314150293773	1	135,75	496
NS010-2528*	7314150293780	1	151,78	496
NS010-2628	7314150293797	1	154,89	496
NS010-2730	7314150293803	1	158,02	496
NS010-2732	7314150293810	1	174,34	496
NS010-3032	7314150293827	1	185,07	496
NS010-3036	7314150293834	1	231,32	496
NS010-3236	7314150293841	1	277,60	496
NS010-3641	7314150293858	1	416,39	496
NS010-4146*	7314150293865	1	453,99	496
NS010-4650*	7314150293872	1	482,36	496
NS011-0607	7314150317271	1	25,60	496
NS011-0809	7314150317288	1	27,63	496
NS011-1011	7314150317295	1	33,44	496
NS011-1213	7314150317301	1	43,63	496
NS011-1415	7314150317318	1	49,45	496
NS011-1617	7314150317325	1	53,81	496
NS011-1819	7314150317332	1	66,89	496
NS011-2022	7314150317349	1	78,51	496
NS011-2123	7314150317356	1	81,45	496
NS011-2426	7314150317363	1	99,73	496
NS011-2528	7314150317370	1	99,73	496
NS011-2729	7314150317387	1	109,82	496
NS011-3032	7314150317394	1	134,48	496
NS041-12-50*	7314150502547	1	2.102,03	512
NS041-16-100*	7314150502561	1	2.389,98	512
NS041-16-200	7314150502578	1	2.599,62	512
NS041-16-260	7314150502585	1	2.804,63	512
NS041-24-670*	7314150502608	1	8.335,56	512
NS041-32-900*	7314150502622	1	9.467,78	512
NS041-8-25	7314150502646	1	1.561,55	512
NS100-100	7314150294305	1	1.339,31	497
NS100-105	7314150294312	1	1.629,35	497
NS100-110	7314150294329	1	1.442,94	497
NS100-115	7314150294336	1	1.729,04	497
NS100-120	7314150294343	1	1.849,40	497
NS100-17	7314150293889	1	79,47	496
NS100-19	7314150293896	1	82,64	496
NS100-22	7314150293902	1	85,83	496
NS100-24	7314150293919	1	92,17	496
NS100-25*	7314150293926	1	103,33	496
NS100-27	7314150293933	1	104,29	496
NS100-28	7314150293940	1	105,29	496
NS100-29*	7314150293957	1	108,07	496

			€	
NS100-30	7314150293964	1	109,10	496
NS100-32	7314150293971	1	114,83	496
NS100-33*	7314150293988	1	121,59	496
NS100-34	7314150293995	1	144,42	496
NS100-35*	7314150294008	1	151,00	496
NS100-36	7314150294015	1	152,44	496
NS100-37*	7314150294022	1	166,89	497
NS100-38	7314150294039	1	168,47	497
NS100-41	7314150294046	1	182,77	497
NS100-42	7314150294053	1	214,20	497
NS100-45*	7314150294060	1	230,47	497
NS100-46	7314150294077	1	232,67	497
NS100-47*	7314150294084	1	250,34	497
NS100-50	7314150294091	1	270,20	497
NS100-52	7314150294107	1	297,23	497
NS100-54	7314150294114	1	309,95	497
NS100-55	7314150294121	1	309,95	497
NS100-56	7314150294138	1	324,70	497
NS100-58	7314150294145	1	389,39	497
NS100-60	7314150294152	1	393,11	497
NS100-63*	7314150294169	1	417,07	497
NS100-65	7314150294176	1	429,14	497
NS100-67*	7314150294183	1	510,87	497
NS100-70	7314150294190	1	564,24	497
NS100-71*	7314150294206	1	591,12	497
NS100-75	7314150294213	1	635,39	497
NS100-77*	7314150294220	1	709,36	497
NS100-80	7314150294237	1	749,28	497
NS100-82	7314150294244	1	821,65	497
NS100-85	7314150294251	1	853,74	497
NS100-88*	7314150294268	1	967,26	497
NS100-90	7314150294275	1	872,47	497
NS100-94*	7314150294282	1	894,45	497
NS100-95	7314150294299	1	872,47	497
NS104-100	7314150294947	1	811,75	497
NS104-105	7314150294954	1	879,40	497
NS104-110	7314150294961	1	1.041,76	497
NS104-115	7314150294978	1	1.041,76	497
NS104-120	7314150294985	1	1.352,92	497
NS104-17	7314150294350	1	86,60	497
NS104-19	7314150294367	1	88,19	497
NS104-20*	7314150294374	1	88,96	497
NS104-22	7314150294381	1	89,75	497
NS104-24	7314150284795	1	91,34	497
NS104-25*	7314150294398	1	102,66	497
NS104-26	7314150294404	1	102,71	497
NS104-27	7314150284801	1	102,71	497
NS104-28	7314150294411	1	107,76	497
NS104-29	7314150294428	1	110,16	497
NS104-30	7314150284818	1	114,43	497
NS104-31	7314150294435	1	118,08	497
NS104-32	7314150284825	1	120,04	497
NS104-33	7314150294442	1	131,71	497
NS104-34	7314150294459	1	139,28	497
NS104-35	7314150294466	1	142,91	497
NS104-36	7314150284832	1	140,08	497
NS104-37	7314150294473	1	140,73	497
NS104-38	7314150294480	1	146,67	497
NS104-39	7314150294497	1	177,31	497
NS104-40	7314150294503	1	180,65	497
NS104-41	7314150284849	1	183,66	497
NS104-42	7314150294510	1	199,74	497
NS104-43*	7314150294527	1	204,95	497
NS104-44*	7314150294534	1	199,74	497
NS104-45*	7314150294541	1	203,22	497
NS104-46	7314150284856	1	208,43	497
NS104-47	7314150294558	1	225,64	497
NS104-48	7314150294565	1	229,57	497
NS104-49	7314150294572	1	233,50	497
NS104-50	7314150284863	1	237,42	497
NS104-51	7314150294589	1	243,33	497
NS104-52	7314150294596	1	249,30	497
NS104-53*	7314150294602	1	251,29	497
NS104-54	7314150294619	1	253,29	497
NS104-55	7314150284870	1	270,57	497
NS104-56	7314150294626	1	277,91	497
NS104-57	7314150294633	1	282,56	497
NS104-58*	7314150294640	1	287,18	497
NS104-59*	7314150294657	1	291,82	497
NS104-60	7314150284887	1	317,93	497
NS104-61*	7314150294664	1	329,23	497
NS104-62*	7314150294671	1	335,86	497
NS104-63	7314150294688	1	346,39	497
NS104-64*	7314150294695	1	356,86	497
NS104-65	7314150294701	1	347,13	497
NS104-66*	7314150294718	1	337,75	497
NS104-67*	7314150294725	1	343,17	497
NS104-68*	7314150294732	1	414,31	497
NS104-69*	7314150294749	1	414,31	497
NS104-70	7314150284894	1	392,33	497
NS104-71*	7314150294756	1	417,26	497
NS104-72*	7314150294763	1	420,23	497
NS104-73*	7314150294770	1	423,18	497
NS104-74*	7314150294787	1	426,14	497
NS104-75	7314150284900	1	473,51	497
NS104-76*	7314150294794	1	492,49	497

\* Hasta agotar existencias

			€	
NS104-77*	7314150294800	1	498,64	497
NS104-78*	7314150294817	1	513,19	497
NS104-79*	7314150294824	1	527,76	497
NS104-80	7314150284917	1	542,33	497
NS104-81*	7314150294831	1	572,67	497
NS104-82*	7314150294848	1	579,43	497
NS104-83*	7314150294855	1	586,19	497
NS104-84*	7314150294862	1	592,95	497
NS104-85	7314150284924	1	599,72	497
NS104-86*	7314150294879	1	664,33	497
NS104-87*	7314150294886	1	678,97	497
NS104-88*	7314150294893	1	693,59	497
NS104-89*	7314150294909	1	708,24	497
NS104-90	7314150284931	1	667,29	497
NS104-92*	7314150294916	1	760,19	497
NS104-94*	7314150294923	1	769,68	497
NS104-95	7314150284948	1	690,02	497
NS104-98*	7314150294930	1	818,70	497
NS106-100*	7314150295418	1	653,93	498
NS106-104*	7314150295425	1	672,09	498
NS106-108*	7314150295432	1	688,88	498
NS106-112*	7314150295449	1	712,95	498
NS106-114*	7314150295456	1	753,83	498
NS106-116*	7314150295463	1	853,05	498
NS106-120*	7314150295470	1	889,46	498
NS106-124*	7314150295487	1	960,60	498
NS106-126*	7314150295494	1	1.037,44	498
NS106-128*	7314150295500	1	1.078,95	498
NS106-132*	7314150295517	1	1.120,44	498
NS106-136*	7314150295524	1	1.303,17	498
NS106-138*	7314150295531	1	1.335,72	498
NS106-144*	7314150295548	1	1.593,95	498
NS106-146*	7314150295555	1	1.613,62	498
NS106-150*	7314150295562	1	1.711,46	498
NS106-156*	7314150295579	1	1.912,82	498
NS106-158*	7314150295586	1	2.737,73	498
NS106-20	7314150294992	1	62,44	498
NS106-22*	7314150295005	1	79,25	498
NS106-24*	7314150295012	1	83,50	498
NS106-25*	7314150295029	1	89,46	498
NS106-26	7314150295036	1	91,06	498
NS106-28	7314150295043	1	93,99	498
NS106-30	7314150295050	1	95,57	498
NS106-32*	7314150295067	1	97,13	498
NS106-34	7314150295074	1	100,26	498
NS106-36	7314150295081	1	103,40	498
NS106-38*	7314150295098	1	106,40	498
NS106-40	7314150295104	1	108,24	498
NS106-42	7314150295111	1	100,52	498
NS106-44*	7314150295128	1	103,13	498
NS106-45*	7314150295135	1	105,54	498
NS106-46	7314150295142	1	137,93	498
NS106-48	7314150295159	1	139,98	498
NS106-50*	7314150295166	1	145,60	498
NS106-52	7314150295173	1	176,26	498
NS106-54*	7314150295180	1	159,42	498
NS106-56*	7314150295197	1	163,31	498
NS106-58	7314150295203	1	202,92	498
NS106-60	7314150295210	1	221,57	498
NS106-62*	7314150295227	1	201,84	498
NS106-64	7314150295234	1	235,97	498
NS106-66*	7314150295241	1	220,90	498
NS106-68*	7314150295258	1	233,62	498
NS106-70*	7314150295265	1	246,38	498
NS106-71*	7314150295272	1	246,38	498
NS106-72	7314150295289	1	289,19	498
NS106-74*	7314150295296	1	304,41	498
NS106-76*	7314150295302	1	311,16	498
NS106-78*	7314150295319	1	295,04	498
NS106-80*	7314150295326	1	324,71	498
NS106-82*	7314150295333	1	325,51	498
NS106-84*	7314150295340	1	338,22	498
NS106-88*	7314150295357	1	405,86	498
NS106-90*	7314150295364	1	417,77	498
NS106-92*	7314150295371	1	435,93	498
NS106-94*	7314150295388	1	459,99	498
NS106-96	7314150295395	1	487,05	498
NS106-98*	7314150295401	1	476,83	498
NS200-1200*	7314150295661	1	1.766,59	499
NS200-200	7314150295693	1	202,36	499
NS200-250	7314150295609	1	234,99	499
NS200-300	7314150295616	1	254,60	499
NS200-350	7314150295623	1	300,28	499
NS200-450	7314150295630	1	508,59	499
NS200-600	7314150295647	1	750,18	499
NS200-900	7314150295654	1	1.292,86	499
NS202-350	7314150299690	1	263,64	499
NS203-200	7314150359509	1	88,27	499
NS203-215	7314150359516	1	132,33	499
NS203-290	7314150359523	1	144,01	499
NS203-400	7314150359530	1	189,25	499
NS203-490	7314150359547	1	281,39	499
NS203-800	7314150359554	1	667,30	499
NS204-30	7314150295685	1	153,78	499
NS204-32	7314150295692	1	209,28	499
NS204-35	7314150295708	1	173,25	499







NS204-40	7314150295715	1	209,28	499
NS204-45	7314150295722	1	230,67	499
NS204-48	7314150295739	1	254,03	499
NS204-50	7314150295746	1	268,61	499
NS204-55*	7314150295753	1	279,33	499
NS204-60	7314150295760	1	297,82	499
NS204-65	7314150295777	1	333,84	499
NS204-70	7314150295784	1	373,75	499
NS204-75*	7314150295791	1	417,55	499
NS204-80	7314150295807	1	476,92	499
NS204-85*	7314150295814	1	537,26	499
NS204-90	7314150295821	1	564,52	499
NS220-06	7314150347216	1	65,25	500
NS220-07	7314150347223	1	66,89	500
NS220-08	7314150347230	1	68,52	500
NS220-09	7314150347247	1	70,14	500
NS220-10	7314150347254	1	71,79	500
NS220-11	7314150347261	1	73,40	500
NS220-12	7314150347278	1	75,05	500
NS220-13	7314150347285	1	76,68	500
NS220-14	7314150347292	1	78,32	500
NS220-15	7314150347308	1	79,94	500
NS220-16	7314150347315	1	81,58	500
NS220-17	7314150347322	1	88,10	500
NS220-18	7314150347339	1	89,71	500
NS220-19	7314150347346	1	91,35	500
NS220-20	7314150347353	1	92,99	500
NS220-21	7314150347360	1	97,89	500
NS220-22	7314150347377	1	101,15	500
NS220-23	7314150347384	1	104,41	500
NS220-24	7314150347391	1	110,92	500
NS220-25	7314150347407	1	114,20	500
NS220-26	7314150347414	1	122,35	500
NS220-27	7314150347421	1	127,26	500
NS220-28	7314150347438	1	130,51	500
NS220-29	7314150347445	1	142,39	500
NS220-30	7314150347452	1	143,56	500
NS220-32	7314150347469	1	146,83	500
NS220-34*	7314150347476	1	127,11	500
NS220-36	7314150347483	1	139,82	500
NS220-41	7314150347490	1	169,94	500
NS224-17	7314150355525	1	89,49	500
NS224-18*	7314150355532	1	89,76	500
NS224-19	7314150355549	1	90,04	500
NS224-21*	7314150355556	1	99,03	500
NS224-22	7314150355563	1	100,10	500
NS224-23	7314150355570	1	105,74	500
NS224-24	7314150355587	1	132,72	500
NS224-26*	7314150355594	1	134,12	500
NS224-27	7314150355617	1	142,28	500
NS224-28*	7314150355624	1	149,39	500
NS224-29	7314150355631	1	159,74	500
NS224-30	7314150355648	1	168,46	500
NS224-32	7314150355655	1	190,26	500
NS224-34	7314150355662	1	205,54	500
NS224-36	7314150355679	1	219,15	500
NS224-38	7314150355686	1	234,43	500
NS224-41	7314150355693	1	258,42	500
NS224-46	7314150355709	1	305,28	500
NS224-50	7314150355716	1	334,74	500
NS228-22	7314150355914	1	131,47	501
NS228-24	7314150355921	1	145,18	501
NS228-26*	7314150355938	1	179,45	501
NS228-27*	7314150355945	1	185,66	501
NS228-28*	7314150355952	1	189,41	501
NS228-29*	7314150355969	1	193,77	501
NS228-30*	7314150355976	1	198,12	501
NS228-31*	7314150355983	1	214,33	501
NS228-32	7314150355990	1	229,28	501
NS228-34*	7314150356003	1	241,75	501
NS228-36	7314150356010	1	259,20	501
NS228-38*	7314150356027	1	279,12	501
NS228-41	7314150356034	1	317,13	501
NS228-46	7314150356041	1	352,65	501
NS228-50	7314150356058	1	387,54	501
NS228-55	7314150356065	1	437,38	501
NS228-60	7314150356072	1	488,47	501
NS228-65	7314150356089	1	542,05	501
NS228-70	7314150356096	1	596,89	501
NS228-75*	7314150356102	1	651,71	501
NS228-80*	7314150356119	1	708,41	501
NS232-16-24	7314150356331	1	127,74	501
NS232-24-16	7314150356355	1	155,81	501
NS232-24-32*	7314150356348	1	260,63	501
NS232-32-24	7314150356362	1	253,07	501
NS234-16-100	7314150356416	1	123,87	501
NS234-16-200	7314150356423	1	136,02	501
NS234-16-250	7314150356430	1	149,39	501
NS234-24-200	7314150356447	1	204,01	501
NS234-32-250	7314150356454	1	352,20	501
NS236-16	7314150356522	1	151,40	501
NS236-24*	7314150356539	1	365,41	501
NS236-32*	7314150356515	1	499,06	501
NS238-16-250	7314150356577	1	212,54	502
NS238-24-250	7314150356584	1	421,41	502
NS238-32-300*	7314150356591	1	529,51	502



NS240-16-230	7314150356737	1	195,62	502
NS242-16	7314150356638	1	318,19	502
NS242-24	7314150356645	1	511,29	502
NS242-32*	7314150356652	1	991,81	502
NS243-16-400	7314150356690	1	249,17	502
NS247-26*	7314150356751	1	150,71	503
NS248-16-52*	7314150356713	1	80,68	503
NS300-10-200	7314150317783	1	73,66	503
NS300-10-300	7314150316205	1	96,05	503
NS300-11-250	7314150317790	1	88,04	503
NS300-11-300	7314150317806	1	104,05	503
NS300-11-350	7314150316212	1	120,06	503
NS300-12-400	7314150325153	1	126,46	503
NS300-13-450	7314150325160	1	136,07	503
NS300-3-50	7314150317677	1	17,45	503
NS300-3-75	7314150317684	1	20,35	503
NS300-4-75	7314150317691	1	21,82	503
NS300-4-5-100	7314150316175	1	26,44	503
NS300-4-5-50	7314150317707	1	18,91	503
NS300-5-100	7314150317721	1	26,16	503
NS300-5-75	7314150317714	1	23,27	503
NS300-6-100	7314150316182	1	27,63	503
NS300-6-125	7314150317738	1	31,30	503
NS300-6-150	7314150317745	1	34,58	503
NS300-7-150	7314150317752	1	39,14	503
NS300-8-150	7314150316199	1	42,58	503
NS300-8-200	7314150317769	1	50,91	503
NS300-9-250	7314150317776	1	58,17	503
NS301-10-200	7314150317882	1	78,47	503
NS301-10-300	7314150317899	1	93,27	503
NS301-3-50	7314150317813	1	21,82	503
NS301-4-100	7314150317820	1	27,63	503
NS301-4-150	7314150317837	1	46,11	503
NS301-5-100	7314150317844	1	43,12	503
NS301-5-200	7314150317851	1	46,21	503
NS301-6-100	7314150317868	1	46,34	503
NS301-8-150	7314150317875	1	62,74	503
NS302-0-50	7314150316229	1	24,71	504
NS302-1-100	7314150316236	1	24,71	504
NS302-2-125	7314150316243	1	31,49	504
NS302-3-150	7314150316250	1	43,63	504
NS302-4-300	7314150316267	1	69,80	504
NS304-0-50	7314150316274	1	24,71	504
NS304-1-100	7314150316281	1	24,71	504
NS304-2-125	7314150316298	1	29,09	504
NS304-3-150	7314150316304	1	43,63	504
NS304-4-300	7314150316311	1	69,80	504
NS320-10	7314150318162	1	48,83	504
NS320-2	7314150318087	1	31,67	504
NS320-3	7314150318094	1	32,05	504
NS320-4	7314150318100	1	32,56	504
NS320-5	7314150318117	1	33,97	504
NS320-6	7314150318124	1	35,42	504
NS320-7	7314150318131	1	39,22	504
NS320-8	7314150318148	1	41,15	504
NS320-9	7314150318155	1	45,47	504
NS400-160	7314150316106	1	130,86	504
NS400-180	7314150316113	1	145,41	504
NS400-200	7314150316120	1	159,96	504
NS402-160	7314150316137	1	169,95	505
NS402-200	7314150325177	1	174,49	505
NS403-160	7314150318209	1	159,96	505
NS403-180	7314150318193	1	174,49	505
NS404-160	7314150318216	1	123,59	505
NS405-160	7314150318247	1	123,59	505
NS406-160	7314150316144	1	130,86	505
NS406-180	7314150318261	1	156,69	505
NS406-200	7314150316151	1	157,47	505
NS407-160	7314150318278	1	285,26	505
NS408-250	7314150316168	1	196,98	506
NS408-300	7314150318292	1	238,54	506
NS411-200	7314150318322	1	189,04	506
NS412-200	7314150318339	1	116,32	506
NS413-180	7314150318384	1	294,66	506
NS413-200	7314150318377	1	294,66	506
NS500-1000-FB	7314150296019	1	160,10	507
NS500-1500-FB	7314150296026	1	184,62	507
NS500-2000	7314150291847	1	279,73	507
NS500-2000-FB	7314150284955	1	226,05	507
NS500-2500	7314150291854	1	349,56	506
NS500-2500-FB	7314150284962	1	283,54	507
NS500-3000	7314150291861	1	419,40	506
NS500-3000-FB	7314150284979	1	319,91	507
NS500-3500-FB	7314150284986	1	452,09	507
NS500-4000	7314150291878	1	555,95	506
NS502-1000-FB	7314150284993	1	122,37	507
NS502-10000-FB	7314150285068	1	947,05	507
NS502-12000-FB*	7314150318407	1	1.082,34	507
NS502-1500-FB	7314150318438	1	162,35	507
NS502-2000-FB	7314150285006	1	197,96	507
NS502-2500-FB	7314150285013	1	251,95	507
NS502-3000-FB	7314150285020	1	305,93	507
NS502-450-FB	7314150296033	1	90,98	507
NS502-4500-FB	7314150285037	1	365,29	507
NS502-5000-FB	7314150285044	1	432,93	507
NS502-6800-FB	7314150318445	1	568,23	507



NS502-8000-FB	7314150285051	1	679,80	507
NS504-100-FB	7314150296040	1	58,17	507
NS504-1000-FB	7314150285099	1	160,10	507
NS504-1500-FB	7314150285105	1	189,04	507
NS504-200-FB	7314150296057	1	61,80	507
NS504-2000-FB	7314150285112	1	232,65	507
NS504-300-FB	7314150296064	1	66,89	507
NS504-500-FB	7314150285075	1	91,61	507
NS504-800-FB	7314150285082	1	120,67	507
NS506-300	7314150285129	1	56,51	507
NS506-300-FB	7314150318469	1	57,37	508
NS506-450	7314150285136	1	75,34	507
NS506-450-FB	7314150318476	1	76,49	508
NS506-700	7314150296071	1	105,97	507
NS506-700-FB	7314150285143	1	96,88	508
NS506-900	7314150296088	1	141,26	507
NS506-900-FB	7314150285150	1	147,42	508
NS508-500-FB	7314150318544	1	91,41	508
NS508-700-FB	7314150318537	1	108,03	508
NS512-200-FB	7314150318568	1	78,10	508
NS512-400-FB	7314150318575	1	98,06	508
NS512-600-FB	7314150318582	1	108,03	508
NS512-900-FB	7314150318599	1	131,28	508
NS600-100-50	7314150296101	1	37,67	508
NS600-135-50	7314150296118	1	71,58	508
NS600-150-25	7314150296125	1	33,91	508
NS600-150-30	7314150301676	1	30,16	508
NS600-150-40	7314150296132	1	37,67	508
NS600-150-50	7314150296149	1	64,05	508
NS600-180-13	7314150296156	1	30,16	508
NS600-180-32	7314150285167	1	43,32	508
NS600-180-50	7314150285174	1	96,07	508
NS600-200-20	7314150296163	1	84,77	508
NS600-200-30	7314150296170	1	103,60	508
NS600-200-40	7314150296187	1	152,08	508
NS600-200-50	7314150301782	1	74,63	508
NS600-230-40	7314150296194	1	109,26	508
NS600-250-40	7314150296200	1	169,53	508
NS600-300-50	7314150296217	1	331,54	508
NS600-80-13	7314150296095	1	10,17	508
NS602-460	7314150285181	1	152,48	509
NS602-600	7314150285198	1	210,07	509
NS602-760	7314150296224	1	322,66	509
NS602-900	7314150296231	1	374,93	509
NS604-150	7314150296248	1	104,11	509
NS604-200	7314150285204	1	167,01	509
NS604-300	7314150285211	1	273,19	509
NS606-150	7314150285228	1	56,92	509
NS606-200	7314150285235	1	73,18	509
NS606-250	7314150285242	1	98,93	509
NS606-300	7314150285259	1	117,88	509
NS606-400	7314150285266	1	151,79	509
NS608-100	7314150285273	1	34,86	509
NS700-300	7314150325184	1	65,37	509
NS702-200	7314150325191	1	55,83	510
NS704-225	7314150325207	1	124,25	510
NS706-50	7314150325214	1	78,59	510
NS706-80	7314150325221	1	120,60	510
NS708-360	7314150325238	1	168,80	510
NS710-450	7314150325245	1	358,96	511
NS800-1100	7314150296323	1	172,97	511
NS800-1700	7314150285280	1	252,87	511
NS800-2000	7314150296330	1	301,73	511
NS802-290	7314150285297	1	229,82	511
NS804-290	7314150296347	1	51,30	511
NS810-100*	7314150318728	1	1.090,78	511
NS810-150*	7314150318711	1	1.210,94	511
NS810-200*	7314150318704	1	1.293,84	511
NS810-350*	7314150318698	1	1.938,48	511
NSB001-150	7314150292509	5	153,00	494
NSB001-200	7314150284689	5	191,24	494
NSB001-250	7314150284696	5	255,01	494
NSB001-300	7314150284702	5	283,33	494
NSB001-375	7314150292516	5	429,97	494
NSB001-450	7314150292523	3	584,03	494
NSB001-600	7314150292530	3	1.078,29	494
NSB001-900	7314150292547	1	2.413,62	494
NSB002-10	7314150316366	5	50,06	494
NSB002-11	7314150316373	5	54,13	494
NSB002-12	7314150316380	5	59,53	494
NSB002-13	7314150316397	5	62,23	494
NSB002-14	7314150316403	5	64,94	494
NSB002-15	7314150316410	5	74,28	494
NSB002-16	7314150316427	5	77,13	494
NSB002-17	7314150316434	5	87,93	494
NSB002-18	7314150316441	5	92,01	494
NSB002-19	7314150316458	5	94,70	494
NSB002-20	7314150316465	5	97,41	494
NSB002-21	7314150316472	5	105,54	494
NSB002-22	7314150316489	5	108,24	494
NSB002-23	7314150316496	5	113,64	494
NSB002-24	7314150316502	5	128,51	494
NSB002-25	7314150316519	5	135,30	494
NSB002-26	7314150316526	5	141,51	494
NSB002-27	7314150316533	5	145,07	494
NSB002-28	7314150316540	5	178,97	494

\* Hasta agotar existencias



NSB002-29	7314150316557	5	183,14	494
NSB002-30	7314150316564	5	197,71	494
NSB002-31	7314150321728	1	239,34	494
NSB002-32	7314150316571	10	249,73	494
NSB002-33	7314150321735	1	251,35	494
NSB002-34	7314150321742	1	257,11	494
NSB002-35	7314150321759	1	260,15	494
NSB002-36	7314150321766	5	280,95	494
NSB002-38	7314150321773	1	301,77	494
NSB002-40	7314150321780	1	330,90	494
NSB002-41	7314150321797	5	355,87	494
NSB002-42	7314150321803	1	374,61	494
NSB002-46	7314150321810	1	414,15	494
NSB002-50	7314150321827	1	457,85	494
NSB002-52*	7314150321834	1	474,52	494
NSB002-55*	7314150321841	1	499,47	494
NSB002-6	7314150316328	5	62,43	494
NSB002-60*	7314150321858	1	541,09	494
NSB002-65*	7314150321865	1	686,78	494
NSB002-7	7314150316335	5	62,43	494
NSB002-70*	7314150321872	1	790,83	494
NSB002-75*	7314150321889	1	915,72	494
NSB002-8	7314150316342	5	62,43	494
NSB002-80*	7314150321896	1	1.082,20	494
NSB002-9	7314150316359	5	50,47	494
NSB003-10	7314150342709	1	81,03	494
NSB003-11	7314150342716	1	92,15	494
NSB003-12	7314150342723	5	101,35	494
NSB003-13*	7314150342730	1	104,76	494
NSB003-14	7314150342747	1	106,88	494
NSB003-16	7314150342754	5	120,13	495
NSB003-18	7314150342761	1	128,63	495
NSB003-19*	7314150342778	1	132,67	495
NSB003-20	7314150342785	1	139,04	495
NSB003-22	7314150342792	5	150,23	495
NSB003-24	7314150342808	5	153,71	495
NSB003-25*	7314150342815	1	164,18	495
NSB003-26*	7314150342822	1	182,38	495
NSB003-28*	7314150342839	5	188,56	495
NSB003-30	7314150342846	1	220,71	495
NSB003-31*	7314150342853	1	241,55	495
NSB003-32	7314150342860	1	247,21	495
NSB003-34	7314150342877	1	315,70	495
NSB003-36	7314150342884	1	374,28	495
NSB003-38*	7314150342891	1	382,78	495
NSB003-40	7314150342907	1	423,29	495
NSB003-42	7314150342914	1	494,54	495
NSB003-44*	7314150342921	5	514,47	495
NSB003-46*	7314150342938	1	535,05	495
NSB003-48*	7314150342945	1	585,29	495
NSB003-50*	7314150342952	1	618,72	495
NSB003-52	7314150342969	1	629,39	495
NSB003-54*	7314150342976	1	707,28	495
NSB003-56*	7314150342983	1	715,96	495
NSB003-58*	7314150342990	1	742,52	495
NSB003-60*	7314150343010	1	849,99	495
NSB003-62*	7314150343027	1	854,16	495
NSB003-64*	7314150343034	5	868,25	495
NSB003-68*	7314150343041	1	926,19	495
NSB003-72*	7314150343058	1	1.014,94	495
NSB003-8*	7314150342693	1	71,97	494
NSB003-80*	7314150343065	1	1.097,32	495
NSB003-84	7314150343072	1	1.174,29	495
NSB003-88	7314150343089	1	1.204,90	495
NSB006-0607	7314150316588	1	23,42	495
NSB006-0608*	7314150321926	1	23,85	495
NSB006-0708	7314150321933	1	26,53	495
NSB006-0709*	7314150321940	1	26,98	495
NSB006-0809	7314150316595	1	26,55	495
NSB006-0810	7314150321957	1	28,10	495
NSB006-0910	7314150321964	1	28,56	495
NSB006-0911	7314150321971	1	34,34	495
NSB006-1011	7314150316601	1	34,91	495
NSB006-1012	7314150322015	1	37,80	495
NSB006-1013	7314150322022	1	38,44	495
NSB006-1014	7314150322039	1	40,72	495
NSB006-1113	7314150322046	1	46,35	495
NSB006-1114*	7314150322053	1	47,12	495
NSB006-1213	7314150316618	1	46,54	495
NSB006-1214	7314150322060	1	46,92	495
NSB006-1315	7314150322077	1	51,48	495
NSB006-1415	7314150316625	1	52,35	495
NSB006-1416	7314150322084	1	61,14	495
NSB006-1417	7314150322091	1	62,68	495
NSB006-1617	7314150316632	1	61,08	495
NSB006-1618	7314150322107	1	61,56	495
NSB006-1719	7314150322114	1	70,00	495
NSB006-1722*	7314150322121	1	77,79	495
NSB006-1819	7314150316649	1	79,08	495
NSB006-1820*	7314150322138	1	79,73	495
NSB006-1920	7314150322145	1	81,03	495
NSB006-1922	7314150322152	1	82,33	495
NSB006-1924*	7314150322169	1	90,91	495
NSB006-2022	7314150316656	1	90,16	495
NSB006-2122	7314150322176	1	90,91	495
NSB006-2123	7314150316663	1	91,64	495















NSB006-2223	7314150322183	1	92,37	495
NSB006-2224	7314150322190	1	93,11	495
NSB006-2227*	7314150322206	1	98,37	495
NSB006-2326	7314150322213	1	105,68	495
NSB006-2425	7314150322220	1	107,44	495
NSB006-2426	7314150316670	1	109,19	495
NSB006-2427	7314150322237	1	119,44	495
NSB006-2430	7314150322244	1	120,94	495
NSB006-2528	7314150316687	1	122,95	495
NSB006-2629*	7314150322251	1	132,71	495
NSB006-2729	7314150316694	1	132,71	495
NSB006-2730	7314150322336	1	132,71	495
NSB006-2732	7314150322343	1	148,62	495
NSB006-2830	7314150322350	1	148,62	495
NSB006-3031	7314150322367	1	153,93	495
NSB006-3032	7314150316700	1	159,96	495
NSB006-3034*	7314150322374	1	169,89	495
NSB006-3036	7314150322381	1	169,89	495
NSB006-3234	7314150322398	1	169,89	495
NSB006-3235	7314150322404	1	169,89	495
NSB006-3236	7314150322411	1	169,89	495
NSB006-3335*	7314150322428	1	169,89	495
NSB006-3436	7314150322435	1	169,89	495
NSB006-3536*	7314150322442	1	169,89	495
NSB006-3638	7314150322459	1	248,20	495
NSB006-3641	7314150322466	1	248,20	495
NSB006-3642*	7314150322473	1	275,78	495
NSB006-4146	7314150322480	1	319,91	495
NSB006-4650	7314150322497	1	392,61	495
NSB006-5052*	7314150322503	1	398,66	495
NSB006-5055*	7314150322510	1	404,69	495
NSB006-5060*	7314150322527	1	410,72	495
NSB006-5062*	7314150322534	1	416,77	495
NSB006-5560*	7314150322558	1	531,53	495
NSB006-6065*	7314150322565	1	555,70	495
NSB006-6570*	7314150322572	1	591,93	495
NSB010-0607	7314150322589	1	48,84	496
NSB010-0709*	7314150322596	1	48,84	496
NSB010-0809	7314150322602	1	47,84	496
NSB010-0911*	7314150322619	1	51,56	496
NSB010-1011	7314150322626	1	51,56	496
NSB010-1012*	7314150322633	1	57,14	496
NSB010-1214	7314150322640	1	62,76	496
NSB010-1315*	7314150322657	1	74,92	496
NSB010-1417*	7314150322664	1	74,92	496
NSB010-1618	7314150322671	1	99,89	496
NSB010-1719	7314150322688	1	110,16	496
NSB010-1722*	7314150322695	1	118,77	496
NSB010-1819*	7314150322718	1	110,16	496
NSB010-1921*	7314150322725	1	120,87	496
NSB010-1922	7314150322732	1	121,80	496
NSB010-2022	7314150322749	1	122,71	496
NSB010-2123*	7314150322756	1	131,68	496
NSB010-2224*	7314150322763	1	156,34	496
NSB010-2427	7314150322770	1	169,77	496
NSB010-2528*	7314150322787	1	189,36	496
NSB010-2628*	7314150322794	1	200,31	496
NSB010-2730*	7314150322800	1	211,25	496
NSB010-2732*	7314150322817	1	218,75	496
NSB010-3032	7314150322824	1	246,38	496
NSB010-3036*	7314150322831	1	307,98	496
NSB010-3236*	7314150322848	1	369,56	496
NSB010-3641	7314150322855	1	554,34	496
NSB010-4146	7314150322862	1	669,82	496
NSB010-4650*	7314150322879	1	753,55	496
NSB011-0607	7314150317400	1	30,54	496
NSB011-0809	7314150317417	1	32,97	496
NSB011-1011	7314150317424	1	42,18	496
NSB011-1213	7314150317431	1	61,08	496
NSB011-1415	7314150317448	1	75,61	496
NSB011-1617	7314150317455	1	87,24	496
NSB011-1819	7314150317462	1	110,51	496
NSB011-2022	7314150317479	1	133,77	496
NSB011-2123	7314150317486	1	139,59	496
NSB011-2426	7314150317493	1	172,54	496
NSB011-2528*	7314150317509	1	173,06	496
NSB011-2729*	7314150317516	1	187,58	496
NSB011-3032	7314150317523	1	232,65	496
NSB041-12-50	7314150502660	1	3.068,39	512
NSB041-16-100*	7314150502684	1	3.547,54	512
NSB041-16-200	7314150502318	1	3.804,40	512
NSB041-16-260	7314150502707	1	4.061,24	512
NSB041-24-670*	7314150502721	1	12.622,56	512
NSB041-32-900*	7314150502745	1	14.888,14	512
NSB041-8-25	7314150502769	1	2.685,99	512
NSB100-100*	7314150323302	1	1.599,46	497
NSB100-105*	7314150323319	1	1.890,27	497
NSB100-110*	7314150323326	1	2.035,73	497
NSB100-115*	7314150323333	1	2.439,34	497



NSB100-120*	7314150323340	1	2.609,18	497
NSB100-17*	7314150322886	1	104,05	497
NSB100-19*	7314150322893	1	108,23	497
NSB100-22	7314150322909	1	112,39	497
NSB100-24	7314150322916	1	120,73	497
NSB100-25	7314150322923	1	135,27	497
NSB100-27	7314150322930	1	135,27	497
NSB100-28	7314150322947	1	135,27	497
NSB100-29*	7314150322954	1	166,49	497
NSB100-30	7314150322961	1	166,49	497
NSB100-32	7314150322978	1	167,89	497
NSB100-33	7314150322985	1	187,32	497
NSB100-34*	7314150322992	1	187,32	497
NSB100-35	7314150323005	1	197,71	497
NSB100-36	7314150323012	1	197,71	497
NSB100-37*	7314150323029	1	218,52	497
NSB100-38	7314150323036	1	218,52	497
NSB100-41	7314150323043	1	239,34	497
NSB100-42	7314150323050	1	275,23	497
NSB100-45	7314150323067	1	301,77	497
NSB100-46	7314150323074	1	301,77	497
NSB100-47*	7314150323081	1	327,77	497
NSB100-50	7314150323098	1	353,81	497
NSB100-52	7314150323104	1	389,18	497
NSB100-54*	7314150323111	1	405,83	497
NSB100-55	7314150323128	1	405,83	497
NSB100-56*	7314150323135	1	422,11	497
NSB100-58*	7314150323142	1	506,21	497
NSB100-60*	7314150323159	1	511,07	497
NSB100-63	7314150323166	1	542,19	497
NSB100-65	7314150323173	1	557,88	497
NSB100-67*	7314150323180	1	664,13	497
NSB100-70*	7314150323197	1	733,51	497
NSB100-71*	7314150323203	1	768,45	497
NSB100-75*	7314150323210	1	826,01	497
NSB100-77	7314150323227	1	922,17	497
NSB100-80	7314150323234	1	974,06	497
NSB100-82	7314150323241	1	1.068,12	497
NSB100-85*	7314150323258	1	1.109,85	497
NSB100-88*	7314150323265	1	1.257,43	497
NSB100-90	7314150323272	1	1.405,02	497
NSB100-94*	7314150323289	1	1.440,47	497
NSB100-95*	7314150323296	1	1.476,46	497
NSB104-100*	7314150316885	1	1.276,53	498
NSB104-105*	7314150316892	1	1.354,85	498
NSB104-110*	7314150316908	1	1.586,07	498
NSB104-115*	7314150323937	1	2.380,28	498
NSB104-120*	7314150316915	1	2.034,43	498
NSB104-17	7314150323357	1	101,48	498
NSB104-19	7314150323364	1	104,18	498
NSB104-20*	7314150323371	1	109,59	498
NSB104-22*	7314150323388	1	111,24	498
NSB104-24	7314150316717	1	112,27	498
NSB104-25*	7314150323395	1	133,50	498
NSB104-26*	7314150323401	1	133,51	498
NSB104-27	7314150316724	1	142,05	498
NSB104-28*	7314150323418	1	140,08	498
NSB104-29	7314150323425	1	143,20	498
NSB104-30	7314150316731	1	148,84	498
NSB104-31*	7314150323432	1	153,51	498
NSB104-32	7314150316748	1	162,35	498
NSB104-33*	7314150323449	1	153,51	498
NSB104-34*	7314150323456	1	153,51	498
NSB104-35*	7314150323463	1	153,51	498
NSB104-36	7314150316755	1	189,41	498
NSB104-37	7314150323470	1	206,62	498
NSB104-38	7314150323487	1	224,33	498
NSB104-39*	7314150323494	1	262,20	498
NSB104-40*	7314150323500	1	276,28	498
NSB104-41	7314150316762	1	297,64	498
NSB104-42	7314150323517	1	305,50	498
NSB104-43*	7314150323524	1	313,47	498
NSB104-44	7314150323531	1	305,50	498
NSB104-45*	7314150323548	1	310,82	498
NSB104-46	7314150316779	1	318,80	498
NSB104-47*	7314150323555	1	345,11	498
NSB104-48	7314150323562	1	351,11	498
NSB104-49	7314150323579	1	357,12	498
NSB104-50	7314150316786	1	372,06	498
NSB104-51*	7314150323586	1	372,06	498
NSB104-52*	7314150323593	1	392,33	498
NSB104-53*	7314150323609	1	384,30	498
NSB104-54*	7314150323616	1	387,36	498
NSB104-55	7314150316793	1	412,65	498
NSB104-56*	7314150323623	1	425,05	498
NSB104-57*	7314150323630	1	432,15	498
NSB104-58*	7314150323647	1	439,22	498
NSB104-59	7314150323654	1	446,30	498
NSB104-60	7314150316809	1	453,40	498

					€	
NSB104-61*	7314150323661	1	<b>470,35</b>	498		
NSB104-62*	7314150323678	1	<b>479,82</b>	498		
NSB104-63*	7314150323685	1	<b>494,84</b>	498		
NSB104-64*	7314150323692	1	<b>509,81</b>	498		
NSB104-65	7314150316816	1	<b>495,90</b>	498		
NSB104-66*	7314150323708	1	<b>516,56</b>	498		
NSB104-67*	7314150323715	1	<b>524,82</b>	498		
NSB104-68*	7314150323722	1	<b>633,64</b>	498		
NSB104-69*	7314150323739	1	<b>633,64</b>	498		
NSB104-70	7314150316823	1	<b>633,67</b>	498		
NSB104-71*	7314150323746	1	<b>638,16</b>	498		
NSB104-72*	7314150323753	1	<b>642,69</b>	498		
NSB104-73*	7314150323760	1	<b>647,21</b>	498		
NSB104-74*	7314150323777	1	<b>651,75</b>	498		
NSB104-75	7314150316830	1	<b>656,27</b>	498		
NSB104-76*	7314150323784	1	<b>688,41</b>	498		
NSB104-77*	7314150323791	1	<b>697,00</b>	498		
NSB104-78*	7314150323807	1	<b>717,33</b>	498		
NSB104-79*	7314150323814	1	<b>737,74</b>	498		
NSB104-80*	7314150316847	1	<b>758,10</b>	498		
NSB104-81*	7314150323821	1	<b>800,50</b>	498		
NSB104-82*	7314150323838	1	<b>809,94</b>	498		
NSB104-83*	7314150323845	1	<b>819,39</b>	498		
NSB104-84*	7314150323852	1	<b>828,83</b>	498		
NSB104-85*	7314150316854	1	<b>838,30</b>	498		
NSB104-86*	7314150323869	1	<b>928,64</b>	498		
NSB104-87*	7314150323876	1	<b>949,08</b>	498		
NSB104-88*	7314150323883	1	<b>969,53</b>	498		
NSB104-89*	7314150323890	1	<b>990,01</b>	498		
NSB104-90*	7314150316861	1	<b>932,75</b>	498		
NSB104-92*	7314150323906	1	<b>1.062,60</b>	498		
NSB104-94*	7314150323913	1	<b>1.075,90</b>	498		
NSB104-95*	7314150316878	1	<b>1.089,20</b>	498		
NSB104-98*	7314150323920	1	<b>1.252,12</b>	498		
NSB106-100*	7314150324361	1	<b>850,08</b>	499		
NSB106-104*	7314150324378	1	<b>873,69</b>	499		
NSB106-108*	7314150324385	1	<b>895,52</b>	499		
NSB106-112*	7314150324392	1	<b>926,86</b>	499		
NSB106-114*	7314150324408	1	<b>979,93</b>	499		
NSB106-116*	7314150324415	1	<b>1.108,95</b>	499		
NSB106-120*	7314150324422	1	<b>1.156,27</b>	499		
NSB106-124*	7314150324439	1	<b>1.248,77</b>	499		
NSB106-126	7314150324446	1	<b>1.348,67</b>	499		
NSB106-128*	7314150324453	1	<b>1.402,64</b>	499		
NSB106-132*	7314150324460	1	<b>1.456,61</b>	499		
NSB106-136*	7314150324477	1	<b>1.694,12</b>	499		
NSB106-138*	7314150324484	1	<b>1.736,47</b>	499		
NSB106-144*	7314150324491	1	<b>2.072,14</b>	499		
NSB106-146*	7314150324507	1	<b>2.831,92</b>	499		
NSB106-150*	7314150324514	1	<b>2.902,68</b>	499		
NSB106-156*	7314150324521	1	<b>2.911,10</b>	499		
NSB106-158*	7314150324538	1	<b>3.558,54</b>	499		
NSB106-20*	7314150323944	1	<b>108,23</b>	498		
NSB106-22	7314150323951	1	<b>121,22</b>	498		
NSB106-24*	7314150323968	1	<b>127,70</b>	498		
NSB106-25*	7314150323975	1	<b>99,53</b>	498		
NSB106-26*	7314150323982	1	<b>114,01</b>	498		
NSB106-28	7314150323999	1	<b>135,80</b>	498		
NSB106-30*	7314150324002	1	<b>138,02</b>	498		
NSB106-32*	7314150324019	1	<b>140,32</b>	498		
NSB106-34*	7314150324026	1	<b>144,84</b>	498		
NSB106-36*	7314150324033	1	<b>149,37</b>	498		
NSB106-38*	7314150324040	1	<b>153,69</b>	498		
NSB106-40*	7314150324057	1	<b>169,73</b>	498		
NSB106-42*	7314150324064	1	<b>174,23</b>	498		
NSB106-44*	7314150324071	1	<b>178,79</b>	498		
NSB106-45*	7314150324088	1	<b>225,79</b>	498		
NSB106-46	7314150324095	1	<b>239,10</b>	498		
NSB106-48*	7314150324101	1	<b>242,65</b>	498		
NSB106-50*	7314150324118	1	<b>252,37</b>	498		
NSB106-52*	7314150324125	1	<b>269,59</b>	498		
NSB106-54*	7314150324132	1	<b>290,87</b>	498		
NSB106-56*	7314150324149	1	<b>297,64</b>	498		
NSB106-58*	7314150324156	1	<b>326,59</b>	498		
NSB106-60*	7314150324163	1	<b>365,29</b>	498		
NSB106-62*	7314150324170	1	<b>378,82</b>	499		
NSB106-64*	7314150324187	1	<b>397,57</b>	499		
NSB106-66*	7314150324194	1	<b>378,82</b>	499		
NSB106-68*	7314150324200	1	<b>392,33</b>	499		
NSB106-70*	7314150324217	1	<b>405,86</b>	499		
NSB106-71*	7314150324224	1	<b>410,97</b>	499		
NSB106-72*	7314150324231	1	<b>440,19</b>	499		
NSB106-74*	7314150324248	1	<b>440,19</b>	499		
NSB106-76*	7314150324255	1	<b>454,38</b>	499		
NSB106-78*	7314150324262	1	<b>511,35</b>	499		
NSB106-80*	7314150324279	1	<b>518,04</b>	499		
NSB106-82*	7314150324286	1	<b>497,85</b>	499		
NSB106-84*	7314150324293	1	<b>543,11</b>	499		
NSB106-88*	7314150324309	1	<b>678,89</b>	499		

\* Hasta agotar existencias

					€	
NSB106-90*	7314150324316	1	<b>679,80</b>	499		
NSB106-92	7314150324323	1	<b>754,59</b>	499		
NSB106-94*	7314150324330	1	<b>768,27</b>	499		
NSB106-96*	7314150324347	1	<b>779,26</b>	499		
NSB106-98*	7314150324354	1	<b>826,48</b>	499		
NSB200-1200	7314150324613	1	<b>2.767,93</b>	499		
NSB200-200	7314150324545	1	<b>322,57</b>	499		
NSB200-250	7314150324552	1	<b>374,61</b>	499		
NSB200-300	7314150324569	1	<b>405,83</b>	499		
NSB200-350	7314150324576	1	<b>478,67</b>	499		
NSB200-450	7314150324583	1	<b>582,73</b>	499		
NSB200-600	7314150324590	1	<b>874,08</b>	499		
NSB200-900	7314150324606	1	<b>1.519,24</b>	499		
NSB202-350	7314150324620	1	<b>310,99</b>	499		
NSB203-200	7314150359561	1	<b>132,12</b>	499		
NSB203-215	7314150359578	1	<b>189,05</b>	499		
NSB203-290	7314150359585	1	<b>219,99</b>	499		
NSB203-400	7314150359592	1	<b>270,35</b>	499		
NSB203-490	7314150359608	1	<b>401,94</b>	499		
NSB203-800*	7314150359615	1	<b>935,31</b>	499		
NSB204-30	7314150324637	1	<b>241,39</b>	500		
NSB204-32*	7314150324644	1	<b>331,88</b>	500		
NSB204-35*	7314150324651	1	<b>268,61</b>	500		
NSB204-40*	7314150324668	1	<b>331,88</b>	500		
NSB204-45*	7314150324675	1	<b>404,89</b>	500		
NSB204-48*	7314150324682	1	<b>438,97</b>	500		
NSB204-50	7314150324699	1	<b>466,21</b>	500		
NSB204-55*	7314150324705	1	<b>556,72</b>	500		
NSB204-60	7314150324712	1	<b>599,56</b>	500		
NSB204-65*	7314150324729	1	<b>683,25</b>	500		
NSB204-70*	7314150324736	1	<b>750,42</b>	500		
NSB204-75*	7314150324743	1	<b>835,09</b>	500		
NSB204-80*	7314150324750	1	<b>949,95</b>	500		
NSB204-85*	7314150324767	1	<b>1.057,01</b>	500		
NSB204-90*	7314150324774	1	<b>1.166,01</b>	500		
NSB220-06	7314150354023	1	<b>73,80</b>	500		
NSB220-07	7314150354030	1	<b>75,63</b>	500		
NSB220-08	7314150354047	1	<b>77,49</b>	500		
NSB220-09	7314150354054	1	<b>79,34</b>	500		
NSB220-10	7314150354061	1	<b>73,54</b>	500		
NSB220-11	7314150354078	1	<b>77,34</b>	500		
NSB220-12	7314150354085	1	<b>82,41</b>	500		
NSB220-13	7314150354092	1	<b>86,22</b>	500		
NSB220-14	7314150354108	1	<b>87,48</b>	500		
NSB220-15	7314150354115	1	<b>90,02</b>	500		
NSB220-16	7314150354122	1	<b>93,18</b>	500		
NSB220-17	7314150354139	1	<b>95,73</b>	500		
NSB220-18	7314150354146	1	<b>98,89</b>	500		
NSB220-19	7314150354153	1	<b>103,34</b>	500		
NSB220-20	7314150354160	1	<b>104,61</b>	500		
NSB220-21	7314150354177	1	<b>107,76</b>	500		
NSB220-22	7314150354184	1	<b>111,57</b>	500		
NSB220-23	7314150354191	1	<b>118,08</b>	500		
NSB220-24	7314150354207	1	<b>125,45</b>	500		
NSB220-25	7314150354214	1	<b>140,73</b>	500		
NSB220-26	7314150354221	1	<b>150,88</b>	500		
NSB220-27	7314150354238	1	<b>158,49</b>	500		
NSB220-28	7314150354245	1	<b>167,36</b>	500		
NSB220-29	7314150354252	1	<b>180,29</b>	500		
NSB220-30	7314150354269	1	<b>186,38</b>	500		
NSB220-32	7314150354276	1	<b>204,76</b>	500		
NSB224-17	7314150355723	1	<b>123,31</b>	500		
NSB224-18*	7314150355730	1	<b>152,13</b>	500		
NSB224-19	7314150355747	1	<b>123,87</b>	500		
NSB224-21*	7314150355754	1	<b>136,40</b>	500		
NSB224-22	7314150355761	1	<b>139,67</b>	500		
NSB224-23*	7314150355778	1	<b>174,63</b>	500		
NSB224-24	7314150355785	1	<b>156,83</b>	500		
NSB224-26*	7314150355792	1	<b>163,18</b>	500		
NSB224-27*	7314150355808	1	<b>166,05</b>	500		
NSB224-28	7314150355815	1	<b>176,21</b>	500		
NSB224-29*	7314150355822	1	<b>213,50</b>	500		
NSB224-30	7314150355839	1	<b>226,44</b>	500		
NSB224-32	7314150355846	1	<b>255,</b>			



NSB228-34*	7314150356218	1	368,97	501
NSB228-36*	7314150356225	1	387,41	501
NSB228-38*	7314150356232	1	405,86	501
NSB228-41*	7314150356249	1	415,09	501
NSB228-46	7314150356256	1	451,99	501
NSB228-50	7314150356263	1	479,63	501
NSB228-55*	7314150356270	1	525,79	501
NSB228-60*	7314150356287	1	654,93	501
NSB228-65*	7314150356294	1	701,04	501
NSB228-70*	7314150356300	1	774,84	501
NSB228-75*	7314150356317	1	920,58	501
NSB228-80*	7314150356324	1	977,76	501
NSB232-16-24	7314150356379	1	182,13	501
NSB232-24-16	7314150356393	1	219,87	501
NSB232-24-32	7314150356386	1	370,42	501
NSB232-32-24	7314150356409	1	358,54	501
NSB234-16-100	7314150356461	1	155,50	501
NSB234-16-200	7314150356478	1	172,24	501
NSB234-16-250	7314150356485	1	167,46	501
NSB234-24-200	7314150356492	1	241,61	501
NSB234-32-250	7314150356508	1	503,16	501
NSB236-16	7314150356553	1	230,88	502
NSB236-24*	7314150356546	1	478,45	502
NSB236-32*	7314150356560	1	728,54	502
NSB238-16-250	7314150356621	1	179,41	502
NSB238-24-250*	7314150356614	1	275,10	502
NSB238-32-300*	7314150356607	1	502,37	502
NSB240-16-230*	7314150356744	1	225,79	502
NSB242-16	7314150356669	1	263,14	502
NSB242-24	7314150356676	1	526,29	502
NSB242-32*	7314150356683	1	1.100,41	502
NSB243-16-400	7314150356706	1	349,40	502
NSB247-26*	7314150356768	1	227,26	503
NSB248-16-52*	7314150356720	1	113,98	503
NSB300-10-200	7314150317646	1	94,51	503
NSB300-10-300	7314150295845	1	101,78	503
NSB300-11-250	7314150317653	1	109,06	503
NSB300-11-300	7314150317660	1	116,32	503
NSB300-11-350	7314150295852	1	145,41	503
NSB300-12-400	7314150295869	1	174,49	503
NSB300-13-450	7314150295876	1	203,57	503
NSB300-3-50	7314150317530	1	21,63	503
NSB300-3-75	7314150317547	1	21,82	503
NSB300-4-75	7314150317554	1	27,63	503
NSB300-4-5-100	7314150295838	1	28,56	503
NSB300-4-5-50	7314150317561	1	24,71	503
NSB300-5-100	7314150317585	1	29,09	503
NSB300-5-75	7314150317578	1	30,34	503
NSB300-6-100	7314150285327	1	34,91	503
NSB300-6-125	7314150317592	1	34,91	503
NSB300-6-150	7314150317608	1	42,46	503
NSB300-7-150	7314150317615	1	42,46	503
NSB300-8-150	7314150285334	1	43,63	503
NSB300-8-200	7314150317622	1	67,21	503
NSB300-9-250	7314150317639	1	79,61	503
NSB301-10-200	7314150317974	1	83,71	504
NSB301-10-300	7314150317981	1	103,13	504
NSB301-3-50	7314150317905	1	31,75	504
NSB301-4-100	7314150317912	1	41,40	504
NSB301-4-150	7314150317929	1	54,51	504
NSB301-5-100	7314150317936	1	50,75	504
NSB301-5-200	7314150317943	1	72,72	504
NSB301-6-100	7314150317950	1	72,72	504
NSB301-8-150	7314150317967	1	87,24	504
NSB302-0-50	7314150295883	1	31,99	504
NSB302-1-100	7314150285341	1	31,99	504
NSB302-2-125	7314150285358	1	34,91	504
NSB302-3-150	7314150295890	1	50,91	504
NSB302-4-300	7314150295906	1	79,99	504
NSB304-0-50	7314150295913	1	31,99	504
NSB304-1-100	7314150295920	1	31,99	504
NSB304-2-125	7314150295937	1	34,91	504
NSB304-3-150	7314150295944	1	43,63	504
NSB304-4-300	7314150295951	1	79,99	504
NSB320-10	7314150318070	1	69,71	504
NSB320-2	7314150317998	1	45,23	504
NSB320-3	7314150318001	1	45,77	504
NSB320-4	7314150318018	1	46,49	504
NSB320-5	7314150318025	1	48,51	504
NSB320-6	7314150318032	1	50,59	504
NSB320-7	7314150318049	1	56,01	504
NSB320-8	7314150318056	1	58,78	504
NSB320-9	7314150318063	1	64,93	504
NSB400-160	7314150295968	1	174,49	504
NSB400-180	7314150285365	1	189,04	504
NSB400-200	7314150295975	1	203,57	504
NSB402-160	7314150295982	1	212,27	505
NSB402-200	7314150285372	1	261,48	505
NSB403-160	7314150318179	1	257,40	505



NSB403-180	7314150318186	1	270,55	505
NSB404-160	7314150318223	1	159,96	505
NSB405-160*	7314150318230	1	279,10	505
NSB406-160	7314150295999	1	174,49	505
NSB406-180	7314150318254	1	203,12	505
NSB406-200	7314150296002	1	203,57	505
NSB407-160	7314150318285	1	383,25	506
NSB408-250	7314150285389	1	256,07	506
NSB408-300	7314150318308	1	310,09	506
NSB411-200	7314150318315	1	374,61	506
NSB412-200	7314150318346	1	145,41	506
NSB413-180*	7314150318353	1	383,06	506
NSB413-200	7314150318360	1	383,06	506
NSB500-1000-FB	7314150324828	1	176,89	507
NSB500-1500-FB	7314150324835	1	254,95	507
NSB500-2000	7314150324781	1	334,90	506
NSB500-2000-FB	7314150324842	1	337,15	507
NSB500-2500	7314150324798	1	394,72	506
NSB500-2500-FB	7314150324859	1	432,88	507
NSB500-3000	7314150324804	1	466,49	506
NSB500-3000-FB	7314150324866	1	514,05	507
NSB500-3500-FB	7314150324873	1	649,31	507
NSB500-4000	7314150324811	1	468,23	506
NSB502-1000-FB	7314150316922	1	169,37	507
NSB502-10000-FB	7314150316991	1	1.488,22	507
NSB502-12000-FB	7314150318414	1	2.030,78	507
NSB502-1500-FB	7314150318421	1	225,83	507
NSB502-2000-FB	7314150316939	1	310,52	507
NSB502-2500-FB	7314150316946	1	395,20	507
NSB502-3000-FB	7314150316953	1	479,89	507
NSB502-450-FB	7314150324880	1	121,31	507
NSB502-4500-FB	7314150316960	1	635,15	507
NSB502-5000-FB	7314150316977	1	691,60	507
NSB502-6800-FB	7314150318452	1	959,77	507
NSB502-8000-FB*	7314150316984	1	1.016,23	507
NSB504-100-FB	7314150317004	1	65,44	507
NSB504-1000-FB	7314150317059	1	216,15	507
NSB504-1500-FB	7314150317066	1	292,45	507
NSB504-200-FB	7314150317011	1	88,99	507
NSB504-2000-FB	7314150317073	1	353,48	507
NSB504-300-FB	7314150317028	1	109,32	507
NSB504-500-FB	7314150317035	1	137,32	507
NSB504-800-FB	7314150317042	1	178,00	507
NSB506-300	7314150324897	1	76,30	507
NSB506-300-FB	7314150318490	1	77,77	508
NSB506-450	7314150324903	1	101,71	507
NSB506-450-FB	7314150318483	1	103,67	508
NSB506-700	7314150324910	1	143,05	507
NSB506-700-FB	7314150317080	1	130,79	508
NSB506-900	7314150324927	1	190,70	507
NSB506-900-FB	7314150317097	1	199,02	508
NSB508-500-FB	7314150318513	1	114,46	508
NSB508-700-FB	7314150318520	1	135,27	508
NSB512-200-FB	7314150318643	1	97,82	508
NSB512-400-FB	7314150318636	1	122,78	508
NSB512-600-FB	7314150318629	1	135,27	508
NSB512-900-FB*	7314150318605	1	191,38	508
NSB600-100-50	7314150317110	1	50,86	508
NSB600-135-50	7314150317127	1	96,63	508
NSB600-150-25	7314150317134	1	45,78	508
NSB600-150-30	7314150317141	1	48,69	508
NSB600-150-40*	7314150317158	1	52,62	508
NSB600-150-50	7314150317165	1	86,47	508
NSB600-180-13*	7314150317172	1	39,25	508
NSB600-180-32	7314150317189	1	58,48	508
NSB600-180-50	7314150317196	1	129,70	508
NSB600-200-20	7314150317202	1	114,44	508
NSB600-200-30	7314150317219	1	139,86	508
NSB600-200-40*	7314150317226	1	217,60	508
NSB600-200-50	7314150317233	1	101,99	508
NSB600-230-40	7314150317240	1	147,50	508
NSB600-250-40*	7314150317257	1	228,87	508
NSB600-300-50	7314150317264	1	447,58	508
NSB600-80-13	7314150317103	1	13,74	508
NSB602-460	7314150324934	1	308,77	509
NSB602-600	7314150324941	1	141,05	509
NSB602-760	7314150324958	1	640,44	509
NSB602-900	7314150324965	1	759,24	509
NSB604-150*	7314150324972	1	132,56	509
NSB604-200*	7314150324989	1	177,80	509
NSB604-300*	7314150324996	1	353,47	509
NSB606-150	7314150325009	1	89,64	509
NSB606-200	7314150325016	1	115,27	509
NSB606-250	7314150325023	1	155,82	509
NSB606-300	7314150325030	1	211,33	509
NSB606-400	7314150325047	1	272,03	509
NSB608-100	7314150325054	1	70,67	509
NSB700-300	7314150296255	1	180,57	510
NSB702-200	7314150296262	1	87,93	510



NSB704-225	7314150296279	1	195,69	510
NSB706-50	7314150296286	1	123,79	510
NSB706-80	7314150296293	1	189,94	510
NSB708-360	7314150296309	1	228,81	510
NSB710-450	7314150296316	1	486,53	511
NSB800-1100	7314150325061	1	282,15	511
NSB800-1700	7314150325078	1	412,47	511
NSB800-2000	7314150325085	1	492,20	511
NSB802-290	7314150325092	1	439,53	511
NSB810-100*	7314150318650	1	1.308,92	511
NSB810-150*	7314150318667	1	1.453,12	511
NSB810-200*	7314150318674	1	1.552,61	511
NSB810-350*	7314150318681	1	2.616,93	511
P-HB	7314150125272	25	0,79	531
P-MEC	7314150374342	24	5,70	531
P-MEC-LEAD	7314150374359	12	4,13	531
P1-20	7311518044572	5	43,63	607
P1-23	7311518332501	5	49,09	607
P108-20-F	7311518275518	2	32,77	607
P108-23-F	7311518275525	2	37,46	607
P11	7311518009076	6	40,53	623
P110-20-F	7311518275532	2	31,60	607
P110-23-F	7311518275549	2	35,82	607
P114-SL-40	7311518301149	2	78,56	611
P114-SL-50	7311518301156	2	80,19	611
P114-SL-60	7311518301163	2	87,32	611
P116-SL-40	7311518301101	2	90,60	611
P116-SL-50	7311518301118	2	94,87	611
P116-SL-60	7311518301125	2	97,83	611
P116-SL-70	7311518301132	2	100,84	611
P121-18-F	7311518275662	6	24,00	608
P121-20-F	7311518275631	6	25,16	608
P121-23-F	7311518275648	6	26,34	608
P123-19-BULK30	7311518218218	30	11,79	610
P126-19-F	7311518275297	6	18,02	608
P126-22-F	7311518275303	6	23,18	608
P127-19-BULK30	7311518199333	30	11,60	610
P128-19-F	7311518160814	6	15,12	610
P128-19-BULK30	7311518172329	30	11,91	610
P129-19-BULK30	7311518172336	30	12,93	610
P130-F	7311518333980	6	37,16	612
P138-22-BULK6	7311518328696	6	30,77	608
P138-22-F	7311518301279	6	44,26	608
P140-F	7311518275372	6	47,14	612
P16-40	7311518013479	2	78,37	611
P16-40W	7311518043049	2	78,19	611
P16-50-F	7311518301286	2	94,66	611
P16-60-F	7311518276461	2	97,82	611
P160-SL-60	7311518301170	2	105,52	611
P160-SL-75	7311518301187	1	111,89	611
P160-SL-90	7311518301194	1	119,74	611
P173-SL-85	7311518334703	1	109,22	611
P19-80-F	7311518275365	1	172,76	611
P20	7311518009281	6	48,10	623
P241	7311518008956	5	13,06	603
P262	7311518299286	10	16,81	602
P263	7311518299262	10	18,91	602
P264	7311518299279	10	16,94	602
P266	7311518299293	10	16,74	603
P267	7311518299309	10	17,42	602
P268	7311518299316	10	17,42	602
P269	7311518299323	10	13,68	603
P270	7311518299330	10	16,24	603
P272	7311518299354	5	21,50	602
P274	7311518299347	5	20,89	602
P276	7311518299361	5	21,43	603
P277	7311518299378	5	21,93	602
P278	7311518299385	5	21,79	602
P280-SL-60	7311518346508	2	69,94	611
P280-SL-80	7311518301330	2	76,09	611
P3-20-F	7311518275259	2	62,68	607
P3-23-F	7311518275266	2	65,14	607
P34-27A-F	7311518275464	2	37,46	614
P34-37	7311518002787	2	70,23	614
P5-23-F	7311518275280	2	73,28	607
P51-F	7311518275426	2	53,26	616
P51-SL	7311518301217	2	53,26	616
P51H-SL	7311518301224	2	56,19	616
P52-SL-20	7311518347307	2	91,26	617
P54-SL-25	7311518301231	2	110,02	617
P54H-SL-25	7311518301255	2	110,01	617
P57-25-F	7311518301293	4	40,96	616
P59-25-F	7311518275655	6	34,17	617
P6160	7314150115075	10	82,40	632
P64-20-BULK12	7311518288204	12	40,87	608
P74	7311518124076	40	63,48	618
P75	7311518124083	1	62,35	618
PAGS-2.0	7311518327835	1	32,13	587
PAGS-2.0-900FG	7311518292355	1	77,22	587

PBB-8	7314150399376	8	24,82	530
PBS-700	7314150341689	6	25,37	530
PC-10-DTF	7311518263560	10	28,28	554
PC-10-DTL	7311518263553	10	18,50	554
PC-10-DTR	7311518263546	10	18,50	554
PC-11-19-PS	7311518285548	4	47,25	553
PC-11-19-PS-B	7311518285555	10	32,25	553
PC-12-14-PS	7311518285562	4	42,83	553
PC-12-14-PS-B	7311518285579	10	29,87	553
PC-12-COM	7311518263454	4	22,22	548
PC-12-TEN	7311518263447	4	32,00	552
PC-12-VEN	7311518263430	4	34,62	552
PC-15-GNP	7311518264307	4	29,36	548
PC-15-TBX	7311518263423	4	28,31	552
PC-16-DECO	7311518264987	4	29,36	549
PC-16-FILE-U7	7311518263461	4	19,92	550
PC-19-FILE-U7	7311518263478	4	21,30	550
PC-19-GT7	7311518263362	4	30,03	550
PC-19-GT9	7311518263379	4	30,03	552
PC-20-LAM	7311518258290	4	32,78	551
PC-20-PRC	7311518264291	4	49,64	552
PC-22-FILE-U7	7311518263485	4	22,66	550
PC-22-GT7	7311518263393	4	31,39	550
PC-22-GT9	7311518263409	4	31,39	552
PC-22-INS	7314150154500	4	31,95	549
PC-22-PLC	7314150276318	4	32,11	548
PC-24-FILE-U7	7311518263492	4	32,40	550
PC-24-PLS	7311518263508	4	38,04	548
PC-24-TIM	7311518263515	4	51,17	553
PC-6-DRY	7311518282004	6	23,64	548
PC-9-9/17-PS	7311518285586	4	43,41	553
PC-9-9/17-PS-B	7311518285593	10	32,53	553
PENCIL-200-DISP	7314150125227	1	186,79	531
PG-01-F	7311518329334	6	32,63	608
PG-03-L	7311518242855	2	33,66	608
PG-12-BULK15	7311518334628	15	14,39	608
PG-12-F	7311518328122	10	15,51	608
PG-18-45-F	7311518299033	2	40,96	612
PG-18-60-F	7311518288853	2	44,49	612
PG-19-F	7311518295936	2	60,49	612
PG-56-F	7311518288938	2	42,14	617
PG-57-F	7311518295943	2	44,49	617
PG-72	7311518242534	4	18,33	620
PH-6604-1P	7311518152819	15	3,20	37
PH-6604-25	7311518141134	25	2,05	37
PROF-H	7311518158439	1	25,58	622
PROF-LOPP	7311518288549	1	34,59	622
PROF-SEC	7311518288532	1	21,65	622
PROF-TL	7311518335991	4	20,25	454
PS501-1	7314150338283	1	203,76	637
PS501-2	7314150112432	1	226,98	637
PS501-3	7314150338290	1	234,73	637
PS501-4	7314150338306	1	241,17	637
PU-14*	7314150016266	5	11,24	46
PU-20*	7314150016389	3	16,54	46
PU-21*	7314150016402	3	16,54	46
PU-22*	7314150016426	3	22,15	46
PU-23*	7314150016440	3	23,69	46
PU-24*	7314150016464	3	25,21	46
PU-25*	7314150016488	1	31,94	46
PU-26*	7314150016501	1	32,29	46
PU-27*	7314150016525	1	36,50	46
PU-28*	7314150016549	1	40,03	46
PU-29*	7314150016563	1	40,53	46
PU-30*	7314150016587	1	43,69	46
PU-32*	7314150016600	1	44,91	46
PU-36*	7314150016631	1	58,33	46
PU-6*	7314150016105	5	7,52	46
PU-7*	7314150016129	5	9,67	46
PU-8	7314150016143	5	8,58	46
PU-9*	7314150016167	5	9,11	46
PX-L2	7311518233853	2	58,20	606
PX-L3	7311518233860	2	58,20	606
PX-M1	7311518233815	2	58,20	606
PX-M2	7311518233822	2	58,20	606
PX-M2-L	7311518240714	2	58,20	606
PX-M3	7311518233839	2	58,20	606
PX-S1	7311518233785	2	58,20	606
PX-S2	7311518233792	2	58,20	606
PXR-L2	7311518233914	2	84,26	606
PXR-M1	7311518233877	2	84,26	606
PXR-M2	7311518233884	2	84,26	606
PXR-M2-L	7311518240738	2	84,26	606
PXR-M3	7311518233891	2	84,26	606
PXR-S1	7311518240677	2	84,26	606
PXR-S2	7311518240684	2	84,26	606
PXR-S2-L	7311518346799	2	84,26	606
QC-115A	7314150460007	12	3,24	574
QC-115A-2P	7314150460021	6	6,47	574

\* Hasta agotar existencias







QC-150A	7314150460045	6	<b>7,29</b>	574
QC-150A-2P	7314150460069	6	<b>14,60</b>	574
QC-300A	7314150401925	6	<b>11,48</b>	574
QC-300A-2P	7314150460090	4	<b>22,97</b>	574
QCB-1250	7314150135981	8	<b>52,52</b>	574
QCB-150	7314150135912	6	<b>32,59</b>	574
QCB-300	7314150135936	6	<b>34,94</b>	574
QCB-450	7314150135950	6	<b>37,31</b>	574
QCB-600	7314150135967	4	<b>40,05</b>	574
QCB-900	7314150135974	4	<b>43,78</b>	574
QCG-150	7314150135899	6	<b>21,62</b>	574
QCG-300	7314150135905	6	<b>24,61</b>	574
R1068	7311518044398	1	<b>6,49</b>	610
R1069P	7311518219574	12	<b>5,46</b>	610
R1071	7311518222918	14	<b>10,96</b>	611
R1075-BULK50	7311518220495	50	<b>1,10</b>	611
R1080P	7311518282479	1	<b>6,41</b>	610
R112PG	7311518010058	1	<b>17,46</b>	609
R113PG	7311518044374	30	<b>18,84</b>	609
R114PG	7311518010065	1	<b>17,65</b>	609
R114V	7311518042660	25	<b>33,95</b>	612
R114V-BULK28	7311518177539	28	<b>23,53</b>	612
R115V	7311518243210	8	<b>33,86</b>	612
R115V-BULK14	7311518288341	14	<b>27,53</b>	612
R116V	7311518010164	1	<b>30,62</b>	612
R116V-BULK36	7311518159924	36	<b>26,32</b>	612
R119V	7311518029487	1	<b>52,89</b>	612
R122PG	7311518010072	30	<b>18,54</b>	609
R123PG	7311518044381	30	<b>18,65</b>	609
R124PG	7311518010089	30	<b>18,84</b>	609
R1269P-BULK50	7311518240820	50	<b>1,41</b>	607
R133PG	7311518328252	1	<b>13,21</b>	615
R137E	7311518011574	30	<b>21,34</b>	614
R142P	7311518010126	24	<b>7,94</b>	609
R143PV	7311518010133	1	<b>7,25</b>	612
R143PVCB	7311518255633	1	<b>7,90</b>	612
R144PV	7311518291075	24	<b>7,31</b>	612
R146VC	7311518046545	22	<b>8,47</b>	617
R146VS	7311518046538	24	<b>7,33</b>	612
R146VS-BULK50	7311518159955	50	<b>4,75</b>	612
R147V	7311518044909	24	<b>7,32</b>	617
R148V	7311518223922	1	<b>16,08</b>	609
R1601	7311518044640	1	<b>8,55</b>	610
R160A	7311518201821	1	<b>26,06</b>	612
R160A-BULK28	7311518337216	28	<b>20,48</b>	612
R166V	7311518328085	22	<b>9,80</b>	612
R16V	7311518254513	1	<b>34,04</b>	612
R16V-BULK14	7311518288334	14	<b>23,61</b>	612
R185V	7311518331795	25	<b>25,19</b>	612
R201P	7311518219536	1	<b>21,61</b>	608
R201P-BULK80	7311518225209	80	<b>12,82</b>	608
R202P	7311518219550	1	<b>22,20</b>	609
R211P	7311518234027	1	<b>20,66</b>	606
R211P-BULK80	7311518252212	80	<b>19,23</b>	606
R214SL	7311518301392	1	<b>26,57</b>	612
R214V	7311518042745	1	<b>28,77</b>	612
R214V-BULK28	7311518177553	28	<b>15,48</b>	612
R216SL	7311518301408	8	<b>27,87</b>	612
R221P	7311518229412	1	<b>7,69</b>	608
R221P-BULK50	7311518240653	50	<b>5,84</b>	608
R223P	7311518237554	1	<b>21,02</b>	609
R223P-BULK80	7311518240646	80	<b>17,51</b>	609
R230P	7311518341503	10	<b>24,70</b>	614
R239P	7311518219567	1	<b>8,76</b>	609
R260A	7311518201814	16	<b>25,68</b>	612
R272H	7311518258016	1	<b>10,28</b>	613
R300P	7311518234034	1	<b>20,29</b>	606
R301P	7311518349189	30	<b>21,91</b>	608
R303P	7311518234157	1	<b>21,66</b>	606
R304P	7311518349219	1	<b>25,30</b>	609
R310-0	7314151829797	1	<b>44,11</b>	58
R310-1	7314151829803	1	<b>49,75</b>	58
R310-2	7314151829810	1	<b>73,73</b>	58
R310-3	7314151829827	1	<b>94,22</b>	58
R315V	7311518243234	1	<b>13,05</b>	612
R318V	7311518029500	1	<b>13,99</b>	612
R328V	7311518296056	22	<b>6,87</b>	612
R335V	7311518331801	12	<b>10,94</b>	612
R337E	7311518011598	1	<b>10,69</b>	615
R341P	7311518011529	12	<b>5,20</b>	609
R372H	7311518235406	1	<b>20,25</b>	612
R373A	7311518334710	25	<b>33,74</b>	612
R403P	7311518234164	1	<b>21,89</b>	606
R415V	7311518243241	1	<b>10,22</b>	612
R4230	7311518341510	10	<b>7,36</b>	614
R427AE	7311518176068	18	<b>9,61</b>	615
R434P	7311518223885	1	<b>6,87</b>	609
R434P-BULK50	7311518169916	50	<b>1,99</b>	609
R437E	7311518011611	18	<b>10,69</b>	615



R438P	7311518229429	1	<b>6,50</b>	609
R438P-BULK50	7311518240660	50	<b>2,00</b>	609
R440V	7311518254544	22	<b>7,88</b>	612
R444V	7311518243340	22	<b>6,12</b>	617
R463P	7311518223908	1	<b>7,60</b>	609
R472H	7311518334840	30	<b>17,21</b>	613
R474P	7311518011536	1	<b>5,03</b>	609
R478P	7311518275600	1	<b>9,27</b>	610
R480P	7311518282486	1	<b>7,50</b>	610
R500P	7311518234041	40	<b>20,37</b>	606
R503P	7311518234171	1	<b>19,86</b>	606
R515VS	7311518046514	22	<b>5,45</b>	617
R516V	7311518200824	22	<b>4,58</b>	617
R519V	7311518029517	1	<b>10,41</b>	612
R600P	7311518240783	1	<b>20,20</b>	606
R603P	7311518240790	1	<b>19,33</b>	606
R615V	7311518010119	1	<b>9,66</b>	610
R619V	7311518029494	1	<b>32,67</b>	612
R660V	7311518210281	24	<b>9,04</b>	612
R6725MK	7314151088354	1	<b>266,87</b>	71
R6725ZK	7314151784898	1	<b>256,31</b>	71
R680V	7311518042752	1	<b>24,94</b>	612
R6810M-10	7314150195152	5	<b>13,98</b>	81
R6810M-3.4	7314150195077	5	<b>11,91</b>	81
R6810M-4	7314150195084	5	<b>11,91</b>	81
R6810M-4.5	7314150195091	5	<b>11,91</b>	81
R6810M-5	7314150195107	5	<b>12,16</b>	81
R6810M-6	7314150195114	5	<b>12,16</b>	81
R6810M-7	7314150195121	1	<b>12,43</b>	81
R6810M-8	7314150195138	5	<b>13,13</b>	81
R6810M-9	7314150195145	5	<b>13,13</b>	81
R6810Z-1/4	7314150429448	1	<b>12,17</b>	81
R6810Z-3/16	7314150429387	1	<b>12,17</b>	81
R6810Z-3/8	7314150429394	1	<b>14,81</b>	81
R6810Z-5/16	7314150429400	1	<b>14,81</b>	81
R6810Z-7/32	7314150429417	1	<b>12,17</b>	81
R6822Z	7314150429424	5	<b>14,82</b>	82
R6950	7314151089658	1	<b>107,56</b>	87
R6964A	7314150195176	1	<b>6,59</b>	82
R6967	7314150195169	5	<b>13,92</b>	82
R716VCB	7311518255497	40	<b>28,63</b>	612
R772V	7311518301385	14	<b>6,71</b>	612
R773V	7311518324414	1	<b>6,30</b>	612
R775V	7311518331818	1	<b>10,46</b>	612
R776V	7311518334734	1	<b>19,06</b>	612
R801P	7311518234126	1	<b>39,22</b>	606
R802P	7311518234133	1	<b>39,52</b>	606
R803P	7311518234140	1	<b>39,61</b>	606
R804P	7311518240806	1	<b>34,30</b>	606
R811P	7311518234058	1	<b>26,78</b>	606
R812P	7311518234065	1	<b>25,33</b>	606
R813P	7311518234072	1	<b>25,34</b>	606
R815P	7311518240752	1	<b>26,43</b>	606
R900P	7311518234188	1	<b>8,24</b>	606
R900P-Z	7311518349233	24	<b>9,04</b>	609
R901P	7311518234195	30	<b>7,39</b>	606
R902P	7311518234201	24	<b>6,64</b>	607
R903P	7311518234218	1	<b>5,42</b>	607
R904P	7311518234225	1	<b>7,58</b>	607
R905P	7311518234232	1	<b>6,05</b>	607
R905P-BULK50	7311518252250	50	<b>2,39</b>	607
R906P	7311518234249	1	<b>6,05</b>	607
R906P-BULK50	7311518252267	50	<b>2,53</b>	607
R906P-Z	7311518349264	12	<b>7,09</b>	609
R907P	7311518234256	1	<b>6,28</b>	607
RAIL-10	7314150511075	10	<b>2,93</b>	85
RAIL-340*	7314153003645	3	<b>3,31</b>	85
RAIL-8	7314150511051	10	<b>2,66</b>	85
RAUNI	7311518339289	6	<b>18,49</b>	613
RB-SET-AL06-5P	7314150501489	1	<b>362,88</b>	154
RB-SET-M06X-10P	7314150501557	1	<b>391,92</b>	154
RB-SET1-M06X-5P	7314150501588	1	<b>206,96</b>	154
RB-SET2-M06X-5P	7314150501618	1	<b>164,03</b>	154
RBCP	7311518339272	10	<b>11,28</b>	614
RBCP230	7311518341558	12	<b>10,90</b>	615
RCAM30	7311518346959	20	<b>4,47</b>	615
RCAM36	7311518346973	20	<b>4,47</b>	615
RD1M	7311518341534	15	<b>13,57</b>	615
RD7M	7311518341541	20	<b>25,32</b>	615
RPL230G	7311518341527	8	<b>25,98</b>	615
RT821P	7311518242237	1	<b>51,42</b>	606
RT822P	7311518234102	1	<b>49,33</b>	606
RT823P	7311518234119	6	<b>56,75</b>	606
RT824P	7311518240776	1	<b>67,29</b>	606
RT825P	7311518347147	6	<b>51,44</b>	606
RX 01	7314150103263	1	<b>11,33</b>	633
RX 7390	7314150342587	10	<b>66,95</b>	635
RX 7392	7314150342594	10	<b>66,95</b>	635
RX 7490	7314150103195	10	<b>54,08</b>	635

			€	
RX 7590	7314150103201	10	46,35	635
RX 7890	7314150103218	10	46,35	635
RX 7891	7314150103225	10	46,35	635
RX 7892	7314150103232	10	46,35	635
RX 7893	7314150103249	10	46,35	636
RX 7894	7314150212101	10	54,08	636
RX 8130	7314150103003	10	56,65	630
RX 8131	7314150103010	10	59,23	630
RX 8132	7314150103027	10	61,80	630
RX 8137	7314150392926	10	64,38	630
RX 8140	7314150103034	10	56,65	630
RX 8141	7314150103041	10	59,23	630
RX 8142	7314150103058	10	61,80	630
RX 8142PS	7314150349371	10	82,40	634
RX 8143	7314150103065	10	59,23	630
RX 8144	7314150103072	10	61,80	630
RX 8145	7314150103089	10	64,38	630
RX 8146	7314150103096	10	64,38	630
RX 8147	7314150103102	10	66,95	630
RX 8147PS	7314150425402	10	87,55	634
RX 8148	7314150103119	10	69,53	630
RX 8149	7314150103126	10	79,83	632
RX 8150	7314150103133	10	59,23	630
RX 8151	7314150103140	10	61,80	630
RX 8152	7314150103157	10	64,38	630
RX 8153	7314150412976	10	61,80	630
RX 8154	7314150351435	10	64,38	630
RX 8156	7314150411528	10	64,38	630
RX 8157	7314150383733	10	66,95	630
RX 8158	7314150117130	10	69,53	630
RX 8160	7314150111534	10	64,38	630
RX 8161	7314150111541	10	66,95	630
RX 8161PS	7314150410750	10	84,98	634
RX 8162	7314150111558	10	69,53	630
RX 8164	7314150116270	10	69,53	630
RX 8165	7314150116287	10	72,10	630
RX 8167	7314150383726	10	72,10	630
RX 8168	7314150115495	10	74,68	630
RX 8211	7314150103188	10	48,93	631
RX 8247	7314150103164	10	56,65	631
RX 8248	7314150103171	10	59,23	632
RX8133	7314150476749	10	59,23	630
RX8134	7314150476756	10	61,80	630
RX8136	7314150476770	10	61,80	630
RX8137MX	7314150358519	10	77,25	631
RX8138	7314150346561	10	66,95	630
RX8138MX	7314150349395	10	77,25	631
RX8140M2	7314150476787	10	77,25	634
RX8140PS	7314150360635	10	77,25	634
RX8141PS	7314150349432	10	79,83	634
RX8143PS	7314150360642	10	84,98	634
RX8150M2	7314150476794	10	87,55	634
RX8150PS	7314150358502	10	82,40	634
RX8155	7314150374014	10	66,95	630
RX8160BPS	7314150360048	10	87,55	634
RX8160M2	7314150476800	10	87,55	634
RX8163	7314150476817	10	66,95	630
RX8166	7314150476558	10	69,53	630
RX8233A	7314150436279	10	159,65	633
RX8234A	7314150436286	10	159,65	633
RX8237A	7314150436293	10	159,65	633
S0810L	7314150256594	20	32,80	65
S103	7314150257119	2	297,74	64
S103-CASE	7314150321261	1	63,96	107
S106	7314150103997	2	315,09	64
S108	7314150122257	2	316,15	64
S108-CASE*	7314150349319	1	61,81	107
S1214L	7314150256600	10	60,00	71
S137	7314150450503	2	431,42	65
S138	7314150195022	2	334,18	65
S140T	7314150125203	10	73,03	72
S140T-R	7314150136353	10	44,56	72
S160	7314150104031	6	50,92	66
S160-BOX	7314150508518	6	16,43	107
S160AF	7314150137510	6	50,92	67
S1612L	7314150256617	4	73,78	74
S18HEX	7314150412457	4	101,63	74
S18TORX	7314150412464	4	104,03	74
S240	7314150104017	4	127,67	74
S240-SPL	7314150549009	4	125,35	74
S240AF	7314150111077	4	127,67	75
S240AF-CASE*	7314150187317	1	46,16	107
S290	7314153000859	6	73,74	66
S330	7314150104024	6	80,61	71
S330-CASE*	7314150136223	1	31,94	107
S330AF	7314150137503	6	80,61	72
S330L	7314150256587	4	117,43	72
S330L-CASE*	7311518337674	1	44,74	107
S350AF	7314150137527	2	198,34	75

\* Hasta agotar existencias

			€	
S380	7314150168934	4	116,55	72
S39MH	7314150557301	20	30,39	66
S400	7314150111053	2	189,15	74
S410	7314153019370	2	130,49	64
S410-CASE*	7314150321223	1	52,10	107
S460	7314150111060	6	114,24	66
S460-CASE	7314150321209	1	46,17	107
S4RM-12-15	7314150179954	30	32,07	49
S4RM-16-19	7314150179961	50	38,65	49
S4RM-21-27	7314150179978	20	74,65	49
S4RM-30-36	7314150179985	10	137,41	49
S4RM-4-7	7314150179930	60	21,48	49
S4RM-8-11	7314150179947	60	23,75	49
S4RM/3T	7314150117406	20	97,32	49
S4RM/4T	7314150179916	8	159,09	50
S4RM/5T	7314150179923	8	320,61	50
S530T	7314150169122	4	202,30	72
S560	7314150122264	4	122,00	65
S560-CASE	7314150321216	1	45,84	107
S560MH	7314150547593	4	180,77	76
S71MIX	7314150484966	2	180,25	64
S800	7314150165599	2	299,28	65
S81MIX	7314150180127	2	228,09	64
S87+7	7314150103980	2	270,53	64
S910	7314150104000	2	224,91	64
S95	7314150409167	2	242,14	64
S9HEX	7314150412433	10	50,92	74
S9TORX	7314150412440	10	50,92	74
SB-2448	7314150136056	12	31,59	560
SB-2449	7314150194049	10	28,31	560
SB-3732-2-125	7314151847869	60	6,12	594
SB-3732-2.5-125	7314151847876	60	6,12	594
SB-3732-3.2-125	7314151847883	60	6,12	594
SB-3732-4-125	7314151847890	1	6,12	594
SB-3734N-10-150	7314151848101	1	8,61	593
SB-3734N-2-150	7314151847968	1	7,13	593
SB-3734N-3-150	7314151847975	1	7,13	593
SB-3734N-4-150	7314151847982	60	7,33	593
SB-3734N-5-150	7314151847999	1	7,33	593
SB-3734N-6-150	7314151848071	60	8,61	593
SB-3734N-7-150	7314151848088	1	8,61	593
SB-3734N-8-150	7314151848095	1	8,61	593
SB-3735N-2-100	7314151847906	1	6,52	592
SB-3735N-4-120	7314151847913	60	7,14	592
SB-3735N-5-120	7314151847920	1	7,97	592
SB-3735N-6-150	7314151847937	1	8,61	592
SB-3735N-8-150	7314151847944	1	8,61	592
SB-3740-125	7314150115990	87	11,87	590
SB-3740-150	7314150116003	25	13,50	590
SB-3740-175	7314150116010	25	15,11	590
SB-3740-200	7314150116027	25	15,73	590
SB-3740-250	7314150116034	25	16,59	590
SB-3740-300	7314150116041	25	17,42	590
SB-9526/S6	7314150154234	20	48,44	160
SB111M-10	7314151839864	1	8,81	42
SB111M-11	7314151839871	1	9,48	42
SB111M-12	7314151839888	1	9,93	42
SB111M-13	7314151839895	1	10,41	42
SB111M-14	7314151839901	1	10,83	42
SB111M-15	7314151839918	1	11,15	42
SB111M-16	7314151839925	1	11,99	43
SB111M-17	7314151839932	1	12,50	43
SB111M-18	7314151839949	1	13,09	43
SB111M-19	7314151839956	1	14,84	43
SB111M-20	7314151839963	1	14,96	43
SB111M-21	7314151839970	1	16,98	43
SB111M-22	7314151839987	1	17,11	43
SB111M-23	7314151839994	1	18,07	43
SB111M-24	7314151840006	1	18,87	43
SB111M-25	7314151840013	1	20,36	43
SB111M-26	7314151840020	1	19,83	43
SB111M-27	7314151840037	1	22,20	43
SB111M-28	7314150432103	1	27,38	43
SB111M-29	7314151840051	1	29,65	43
SB111M-30	7314151840068	1	31,75	43
SB111M-32	7314151840075	1	35,34	43
SB111M-5.5	7314151839819	1	7,00	42
SB111M-6	7314151839826	1	7,26	42
SB111M-7	7314151839833	1	7,31	42
SB111M-8	7314151839840	1	7,49	42
SB111M-9	7314151839857	1	8,74	42
SB141.007.075	7314150282753	1	9,26	212
SB141.008.075	7314150282760	1	9,29	212
SB141.009.075	7314150282777	1	9,31	212
SB141.010.075	7314150282784	1	9,34	212
SB141.015.100	7314150282791	1	9,40	212
SB141.020.100	7314150282807	1	9,45	212
SB141.025.125	7314150282814	1	9,82	212



# SB141.027.125



SB141.027.125	7314150282821	1	9,95	212
SB141.030.150	7314150282838	1	11,23	212
SB141.040.150	7314150282845	1	12,98	212
SB142.000.075	7314150282579	1	7,78	484
SB142.001.080	7314150282586	1	9,16	484
SB142.002.100	7314150282593	1	11,25	484
SB142.003.150	7314150282609	1	16,53	484
SB143.020.100	7314150282852	1	4,89	212
SB143.025.100	7314150282869	1	4,97	212
SB143.030.100	7314150282876	1	5,03	212
SB143.040.100	7314150282883	1	5,60	212
SB143.050.100	7314150282890	1	6,78	212
SB143.060.125	7314150282906	1	7,68	212
SB143.080.150	7314150282913	1	10,65	212
SB144.001.100	7314150282951	1	7,87	212
SB144.002.125	7314150282968	1	8,39	212
SB144.003.150	7314150282975	1	8,71	212
SB145.006.100	7314150282920	1	7,56	213
SB146.006.100	7314150282937	1	7,89	213
SB148.001.080	7314150314577	1	10,85	484
SB148.002.100	7314150314584	1	11,51	484
SB149.001.080	7314150314591	1	11,05	484
SB149.002.100	7314150314607	1	11,77	484
SB150.010.100	7314150343492	1	7,26	484
SB150.015.125	7314150343515	1	7,31	484
SB150.020.125	7314150343577	1	7,43	484
SB150.025.150	7314150343584	1	7,66	484
SB190.040.075	7314150281985	1	5,61	210
SB190.040.100	7314150282098	1	5,68	210
SB190.055.100	7314150281992	1	6,98	210
SB190.055.125	7314150282005	1	7,12	210
SB190.065.125	7314150282012	1	8,59	210
SB190.065.150	7314150282029	1	9,65	210
SB190.080.150	7314150282036	1	10,52	210
SB190.080.175	7314150282043	1	10,78	210
SB190.100.200	7314150282050	1	13,94	210
SB190.120.250	7314150282067	1	17,86	210
SB190.140.250	7314150282074	1	18,97	210
SB191.025.075	7314150282081	1	4,25	210
SB191.030.075	7314150282104	1	4,37	210
SB191.030.100	7314150282111	1	4,64	210
SB191.030.200	7314150282128	1	6,96	210
SB191.035.100	7314150282135	1	4,77	210
SB191.040.100	7314150282142	1	5,30	210
SB191.040.125	7314150282159	1	5,77	210
SB191.040.250	7314150282166	1	8,22	210
SB191.055.125	7314150282173	1	7,11	210
SB191.055.150	7314150282180	1	7,85	210
SB191.055.300	7314150282197	1	10,32	210
SB191.065.150	7314150282203	1	9,11	210
SB191.065.300	7314150282210	1	11,72	210
SB192.000.075	7314150282357	1	5,57	211
SB192.000.200	7314150282364	1	7,69	211
SB192.001.100	7314150282371	1	6,66	211
SB192.001.250	7314150282388	1	9,59	211
SB192.002.125	7314150282395	1	8,11	211
SB192.002.300	7314150282401	1	11,87	211
SB192.003.150	7314150282418	1	12,05	211
SB192.004.200	7314150282425	1	16,40	211
SB193.000.075	7314150282456	1	6,49	211
SB193.001.100	7314150282463	1	7,18	211
SB193.002.125	7314150282470	1	8,59	211
SB193.003.150	7314150282487	1	12,67	211
SB193.004.200	7314150282494	1	17,33	211
SB194.004.075	7314150282616	1	7,56	212
SB194.005.075	7314150282623	1	7,37	212
SB194.006.075	7314150282630	1	6,87	212
SB194.007.075	7314150282647	1	6,90	212
SB194.008.075	7314150282654	1	6,92	212
SB194.009.075	7314150282661	1	6,95	212
SB194.010.075	7314150282678	1	6,96	212
SB194.015.100	7314150282685	1	7,11	212
SB194.020.100	7314150282692	1	7,18	212
SB194.025.125	7314150282708	1	7,60	212
SB194.027.125	7314150282715	1	7,78	212
SB194.030.150	7314150282722	1	9,15	212
SB194.040.150	7314150282739	1	10,87	212
SB194.045.150	7314150282746	1	11,61	212
SB195.001.025	7314150282432	1	6,87	211
SB195.002.025	7314150282449	1	6,87	211
SB195.006.050	7314150282951	1	6,87	213
SB195.040.025	7314150282227	1	5,30	210
SB195.050.025	7314150282234	1	6,60	210
SB195.060.025	7314150282241	1	6,87	210
SB195.901.025	7314150282500	1	7,22	211
SB195.902.025	7314150282517	1	7,65	211
SB1952M-10	7314150105205	1	11,71	45
SB1952M-12	7314150105229	1	13,10	45
SB1952M-13	7314150105236	1	14,10	45



SB1952M-14	7314150105243	1	14,22	45
SB1952M-17	7314150105274	1	18,41	45
SB1952M-19	7314150105298	1	21,39	45
SB1952M-24	7314150105342	1	29,33	45
SB1952M-7	7314150105441	1	10,67	45
SB1952M-8	7314150105458	1	10,52	45
SB196.025.075	7314150282258	1	6,93	483
SB196.030.100	7314150282265	1	6,83	483
SB196.035.100	7314150282272	1	7,11	483
SB196.040.100	7314150282289	1	8,12	483
SB196.055.125	7314150282296	1	9,55	483
SB196.065.150	7314150282302	1	11,99	483
SB196.080.175	7314150282326	1	13,17	483
SB196.100.200	7314150282333	1	16,98	483
SB196.120.200	7314150282340	1	19,62	483
SB197.000.075	7314150282524	1	7,09	484
SB197.001.080	7314150282531	1	8,59	484
SB197.002.100	7314150282548	1	10,84	484
SB197.003.150	7314150282555	1	13,69	484
SB197.004.200	7314150282562	1	19,87	484
SB198.040.125	7314150282982	1	10,59	213
SB198.045.125	7314150282999	1	10,59	213
SB198.050.150	7314150283002	1	11,15	213
SB198.055.150	7314150283019	1	11,15	213
SB198.060.150	7314150283026	1	11,61	213
SB198.060.150F	7314150283033	1	16,58	214
SB198.070.150	7314150283040	1	12,15	213
SB198.070.150F	7314150283057	1	17,09	214
SB198.080.150	7314150283064	1	14,46	213
SB198.080.150F	7314150283071	1	18,19	214
SB198.090.150	7314150283088	1	14,74	213
SB198.100.150	7314150283095	1	15,15	213
SB198.110.150	7314150283101	1	15,55	213
SB198.120.150	7314150283118	1	17,47	213
SB198.130.150	7314150283125	1	17,98	213
SB198.140.150	7314150283132	1	19,48	213
SB199.055.125	7314150283149	1	12,40	484
SB199.060.125	7314150283156	1	13,43	484
SB199.070.125	7314150283163	1	14,33	484
SB199.080.125	7314150283170	1	15,75	484
SB199.090.125	7314150283187	1	17,45	484
SB199.100.125	7314150283194	1	19,19	484
SB199.110.125	7314150283200	1	20,90	484
SB199.120.125	7314150287765	1	23,25	484
SB199.130.125	7314150287796	1	25,72	484
SB2058/S26	7314150557455	12	39,40	175
SB2446-EL	7314150312207	10	10,01	570
SB2446-LAP	7314150539475	10	10,61	569
SB27M-10-11	7314150180851	10	15,85	60
SB27M-12-13	7314150180868	10	18,54	60
SB27M-14-15	7314150180875	10	20,55	60
SB27M-16-17	7314150180882	10	23,68	60
SB27M-18-19	7314150180899	10	28,04	60
SB27M-20-22	7314150180905	10	31,77	60
SB27M-21-23	7314150180912	5	35,21	60
SB27M-24-26	7314150180929	5	39,08	60
SB27M-6-7	7314150180837	10	14,85	60
SB27M-8-9	7314150180844	10	15,00	60
SB28M-10	7314150485987	10	14,20	58
SB28M-11	7314150486007	10	14,98	58
SB28M-12	7314150486021	10	15,85	58
SB28M-13	7314150486045	10	16,75	58
SB28M-14	7314150486052	10	19,62	58
SB28M-15	7314150486076	10	20,73	58
SB28M-16	7314150486090	5	21,84	58
SB28M-17	7314150486113	5	22,01	58
SB28M-18	7314150486137	5	27,22	58
SB28M-19	7314150486151	5	28,70	58
SB28M-20	7314150486854	4	30,68	58
SB28M-21	7314150486878	4	33,29	58
SB28M-22	7314150486892	4	38,57	58
SB28M-23	7314150486915	4	40,11	58
SB28M-24	7314150486939	4	42,47	58
SB28M-6	7314150486175	10	12,00	58
SB28M-7	7314150486199	10	12,46	58
SB28M-8	7314150486212	10	13,03	58
SB28M-9	7314150486236	10	13,49	58
SB3654BM-15	7314150270897	5	14,38	596
SB3654BM-20	7314150270903	5	15,27	596
SB3734BM-10	7314150271092	5	14,96	596
SB3734BM-3	7314150270996	5	13,06	596
SB3734BM-4	7314150271016	5	13,42	596
SB3734BM-5	7314150271030	5	13,83	596
SB3734BM-6	7314150271054	5	14,26	596
SB3734BM-8	7314150271078	5	14,52	596
SB3755BM-4	7314150270934	1	10,60	596
SB3755BM-6	7314150270958	5	11,79	596
SB6700SM-10	7314150104383	1	6,02	81
SB6700SM-11	7314150104390	1	6,02	81





SB6700SM-12	7314150104406	1	6,02	81
SB6700SM-13	7314150104413	1	6,02	81
SB6700SM-14	7314150104420	1	6,02	81
SB6700SM-4	7314150104307	1	6,02	81
SB6700SM-4.5	7314150104314	1	6,02	81
SB6700SM-5	7314150104321	1	6,02	81
SB6700SM-5.5	7314150104338	1	6,02	81
SB6700SM-6	7314150104345	1	6,02	81
SB6700SM-7	7314150104352	1	6,02	81
SB6700SM-8	7314150104369	1	6,02	81
SB6700SM-9	7314150104376	1	6,02	81
SB6700SZ-1/2	7314150240609	1	6,07	81
SB6700SZ-1/4	7314150240616	1	6,07	81
SB6700SZ-1/8	7314150412495	5	6,07	81
SB6700SZ-11/32	7314150240623	1	6,07	81
SB6700SZ-3/16	7314150240630	1	6,07	81
SB6700SZ-3/8	7314150240647	1	6,07	81
SB6700SZ-5/16	7314150240654	1	6,07	81
SB6700SZ-5/32	7314150240661	1	6,07	81
SB6700SZ-7/16	7314150240678	1	6,07	81
SB6700SZ-7/32	7314150240685	1	6,07	81
SB6700SZ-9/16	7314150240692	1	6,07	81
SB6700TORX-E4	7314150240722	1	7,78	81
SB6700TORX-E5	7314150240739	1	7,78	81
SB6700TORX-E6	7314150240746	1	7,78	81
SB6700TORX-E7	7314150240753	1	7,78	81
SB6700TORX-E8	7314150240760	1	7,78	81
SB6709F-5.5	7314150240784	1	7,74	85
SB6709F-8	7314150240807	1	7,74	85
SB6709M-4	7314150240821	1	7,63	86
SB6709M-5	7314150240838	1	7,63	86
SB6709M-6	7314150240845	1	7,63	86
SB6709M-8	7314150240852	1	7,63	86
SB6709PH-1	7314150240869	1	8,38	85
SB6709PH-2	7314150240876	1	8,38	85
SB6709PH-3	7314150240883	1	8,38	85
SB6709PZ-1	7314150240890	1	8,84	85
SB6709PZ-2	7314150240906	1	8,84	85
SB6709PZ-3	7314150240913	1	8,84	85
SB6709TORX-R-T10*	7314150240975	1	9,74	86
SB6709TORX-R-T15*	7314150240937	1	9,74	86
SB6709TORX-R-T20*	7314150240944	1	9,74	86
SB6709TORX-R-T25*	7314150240951	1	10,08	86
SB6709TORX-R-T8*	7314150240968	1	9,74	86
SB6709TORX-T10	7314150240982	1	9,34	86
SB6709TORX-T15	7314150240999	1	9,34	86
SB6709TORX-T20	7314150241002	1	9,34	86
SB6709TORX-T25	7314150241019	1	9,61	86
SB6709TORX-T27	7314150241026	1	9,61	86
SB6709TORX-T30	7314150241033	1	9,61	86
SB6709TORX-T40	7314150241040	1	9,61	86
SB6709TORX-T8	7314150241057	1	9,34	86
SB6709TORX-T9	7314150241064	1	9,34	86
SB6950	7314150104987	1	42,79	87
SB6950CBR	7314150548132	1	12,24	88
SB6950MH	7314150553112	1	14,46	87
SB6950MHS	7314150553129	1	14,46	87
SB6950QR	7314150548118	1	23,29	87
SB6950QRS	7314150548125	1	23,33	87
SB6950RN	7314150104994	1	38,76	87
SB6954-5	7314150512188	1	12,68	83
SB6956	7314150241071	1	13,08	83
SB6958-6	7314150500833	1	44,34	83
SB6960-14	7314150512201	1	17,49	84
SB6960-3	7314150512225	1	12,60	84
SB6960-6	7314150512249	1	14,35	84
SB6960F-6	7314150522385	1	7,96	84
SB6961*	7314150104932	1	12,18	84
SB6966	7314150241095	1	25,04	84
SB6973A	7314150507214	1	6,03	84
SB6M-10-11	7314150105731	1	8,21	50
SB6M-12-13	7314150105762	1	9,35	50
SB6M-14-15	7314150105823	1	9,83	50
SB6M-16-17	7314150105847	1	10,89	50
SB6M-17-19	7314150189830	1	11,56	50
SB6M-18-19	7314150105878	1	11,68	50
SB6M-20-22	7314150105915	1	14,01	50
SB6M-21-23	7314150105922	1	15,15	50
SB6M-22-24	7314150105946	1	14,53	50
SB6M-24-26	7314150105953	1	17,22	50
SB6M-24-27	7314150105960	1	17,53	50
SB6M-25-28	7314150189847	1	18,64	50
SB6M-27-29	7314150189854	1	22,66	50
SB6M-30-32	7314150106011	1	25,30	50
SB6M-4-5	7314150106042	1	9,88	50
SB6M-6-7	7314150106073	1	8,30	50
SB6M-8-9	7314150106103	1	7,73	50
SB705.1/4.125	7314150283231	1	13,11	223
SB7400SM-10	7314150241101	1	6,99	88

\* Hasta agotar existencias



SB7400SM-11	7314150241118	1	7,08	88
SB7400SM-12	7314150241125	1	7,19	88
SB7400SM-13	7314150241132	1	7,33	88
SB7400SM-14	7314150241149	1	7,79	88
SB7400SM-15	7314150241156	1	8,09	88
SB7400SM-16	7314150241170	1	8,48	88
SB7400SM-17	7314150241187	1	8,65	88
SB7400SM-18	7314150241194	1	8,86	88
SB7400SM-19	7314150241200	1	9,20	88
SB7400SM-20	7314150241217	1	9,41	88
SB7400SM-21	7314150241224	1	9,66	88
SB7400SM-22	7314150241231	1	9,82	88
SB7400SM-6	7314150241248	1	6,45	88
SB7400SM-7	7314150241255	1	6,45	88
SB7400SM-8	7314150241262	1	6,55	88
SB7400SM-9	7314150241279	1	6,78	88
SB7400TORX-E10	7314150241286	1	11,92	90
SB7400TORX-E11	7314150241293	1	11,92	90
SB7400TORX-E12	7314150241309	1	11,92	90
SB7400TORX-E14	7314150241316	1	12,94	90
SB7400TORX-E16	7314150241323	1	12,94	90
SB7400TORX-E18	7314150241330	1	13,54	90
SB7400TORX-E8	7314150241347	1	11,92	90
SB7409BH-10*	7314150241354	1	15,12	94
SB7409BH-4*	7314150241361	1	12,42	94
SB7409BH-5*	7314150241378	1	12,42	94
SB7409BH-6*	7314150241385	1	12,42	94
SB7409BH-8*	7314150241392	1	13,42	94
SB7409F-10	7314150241408	1	7,46	93
SB7409F-6.5	7314150241415	1	7,46	93
SB7409F-8	7314150241422	1	7,46	93
SB7409M-10	7314150241439	1	12,66	94
SB7409M-3	7314150241446	1	11,63	94
SB7409M-4	7314150241453	1	11,63	94
SB7409M-5	7314150241460	1	11,63	94
SB7409M-6	7314150241477	1	11,63	94
SB7409M-7	7314150241484	1	11,63	94
SB7409M-8	7314150241491	1	12,66	94
SB7409PH-1	7314150241507	1	7,79	93
SB7409PH-2	7314150241514	1	7,79	93
SB7409PH-3	7314150241521	1	7,79	93
SB7409TORX-R-T27	7314150241538	1	14,09	93
SB7409TORX-R-T30	7314150241545	1	14,09	93
SB7409TORX-R-T40	7314150241552	1	16,46	93
SB7409TORX-R-T45	7314150241569	1	16,74	93
SB7409TORX-R-T50	7314150241576	1	17,44	93
SB7409TORX-T20	7314150241583	1	12,77	93
SB7409TORX-T25	7314150241590	1	12,77	93
SB7409TORX-T27	7314150241613	1	12,77	93
SB7409TORX-T30	7314150241620	1	12,77	93
SB7409TORX-T30-L*	7314150241637	1	20,32	94
SB7409TORX-T40	7314150241644	1	15,31	93
SB7409TORX-T40-L*	7314150241651	1	23,63	94
SB7409TORX-T45	7314150241668	1	15,31	93
SB7409TORX-T45-L*	7314150241675	1	23,63	94
SB7409TORX-T50	7314150241682	1	15,31	93
SB7409TORX-T50-L*	7314150241699	1	23,63	94
SB7750	7314150187850	1	60,71	92
SB7750QR	7314150548101	1	32,29	92
SB7750RN	7314153003966	1	54,73	92
SB7756	7314150489176	1	19,50	90
SB7758-10	7314150500840	1	31,39	90
SB7759	7314150254859	1	42,51	91
SB7762	7314153004000	1	20,50	91
SB7766	7314150241743	1	30,90	91
SB7767	7314150254897	1	25,60	85
SB7771	7314150553990	1	13,36	91
SB7773A	7314150516209	1	2,39	92
SB7800DM-10	7314150104451	1	7,81	96
SB7800DM-11	7314150104468	1	7,92	96
SB7800DM-12	7314150104475	1	8,30	96
SB7800DM-13	7314150104482	1	8,61	96
SB7800DM-14	7314150104499	1	8,99	96
SB7800DM-15	7314150104505	1	9,28	96
SB7800DM-16	7314150104512	1	9,46	96
SB7800DM-17	7314150104529	1	9,79	96
SB7800DM-18	7314150104536	1	9,79	96
SB7800DM-19	7314150104543	1	10,11	96
SB7800DM-20	7314150104550	1	10,35	96
SB7800DM-21	7314150104567	1	10,60	96
SB7800DM-22	7314150104574	1	10,92	96
SB7800DM-23	7314150104581	1	11,43	96
SB7800DM-24	7314150104598	1	12,16	96
SB7800DM-25	7314150104604	1	12,34	96
SB7800DM-26	7314150104611	1	12,57	96
SB7800DM-27	7314150104628	1	12,91	96
SB7800DM-28	7314150104635	1	13,75	96
SB7800DM-29	7314150104642	1	14,07	96
SB7800DM-30	7314150104659	1	14,22	96





# SB7800DM-31



SB7800DM-31	7314150471171	1	14,60	96
SB7800DM-32	7314150104666	1	14,75	96
SB7800DM-33	7314150240319	1	12,59	96
SB7800DM-34	7314150327607	1	17,67	96
SB7800DM-36	7314150104673	1	26,90	96
SB7800DM-8	7314150104437	1	7,81	96
SB7800DM-9	7314150104444	1	7,81	96
SB7800DZ-1	7314150234912	1	12,07	96
SB7800DZ-1.1/16	7314150240326	1	12,74	96
SB7800DZ-1.1/2	7314150524518	1	12,07	96
SB7800DZ-1.1/4	7314150240333	1	14,38	96
SB7800DZ-1.1/8	7314150240340	1	13,47	96
SB7800DZ-1.3/16	7314150240357	1	14,23	96
SB7800DZ-1.3/8	7314150524525	1	12,51	96
SB7800DZ-1.5/16	7314150240364	1	14,15	96
SB7800DZ-1.7/16	7314150524532	1	13,00	96
SB7800DZ-1/2	7314150234899	1	8,31	96
SB7800DZ-11/16	7314150234929	1	9,53	96
SB7800DZ-11/32	7314150524549	1	8,85	96
SB7800DZ-13/16	7314150234936	1	10,43	96
SB7800DZ-13/32	7314150524556	1	8,85	96
SB7800DZ-15/16	7314150234943	1	12,00	96
SB7800DZ-19/32	7314150240371	1	9,04	96
SB7800DZ-25/32	7314150240388	1	10,10	96
SB7800DZ-3/4	7314150234950	1	9,94	96
SB7800DZ-3/8	7314150234967	1	7,47	96
SB7800DZ-5/16	7314150524563	1	8,85	96
SB7800DZ-5/8	7314150234974	1	9,28	96
SB7800DZ-7/16	7314150234981	1	7,62	96
SB7800DZ-7/8	7314150234998	1	10,75	96
SB7800DZ-9/16	7314150235001	1	8,81	96
SB7800SM-10	7314150104703	1	7,95	95
SB7800SM-11	7314150104710	1	7,95	95
SB7800SM-12	7314150104727	1	8,30	95
SB7800SM-13	7314150104734	1	8,61	95
SB7800SM-14	7314150104741	1	8,99	95
SB7800SM-15	7314150104758	1	9,28	95
SB7800SM-16	7314150104765	1	9,46	95
SB7800SM-17	7314150104772	1	9,79	95
SB7800SM-18	7314150104789	1	9,79	95
SB7800SM-19	7314150104796	1	10,11	95
SB7800SM-20	7314150240395	1	10,06	95
SB7800SM-21	7314150104819	1	10,60	95
SB7800SM-22	7314150104826	1	10,92	95
SB7800SM-23	7314150104833	1	11,43	95
SB7800SM-24	7314150104840	1	12,16	95
SB7800SM-25	7314150104857	1	12,34	95
SB7800SM-26	7314150104864	1	12,57	95
SB7800SM-27	7314150104871	1	12,91	95
SB7800SM-28	7314150104888	1	13,75	95
SB7800SM-29	7314150240401	1	13,75	95
SB7800SM-30	7314150104895	1	14,22	95
SB7800SM-32	7314150104901	1	14,50	95
SB7800SM-33	7314150240418	1	14,00	95
SB7800SM-34	7314150235018	1	18,47	95
SB7800SM-36	7314150235025	1	25,87	95
SB7800SM-8	7314150104680	1	7,81	95
SB7800SM-9	7314150104697	1	7,95	95
SB7800TORX-E10	7314150240104	1	11,43	97
SB7800TORX-E11	7314150240111	1	11,43	97
SB7800TORX-E12	7314150240128	1	11,43	97
SB7800TORX-E14	7314150240135	1	11,43	97
SB7800TORX-E16	7314150240142	1	11,58	97
SB7800TORX-E18	7314150240159	1	11,58	97
SB7800TORX-E20	7314150240166	1	12,16	97
SB7800TORX-E24	7314150240173	1	13,31	97
SB7800TORX-E8	7314150240180	1	10,23	97
SB7805DM-10	7314150234851	1	18,38	97
SB7805DM-12	7314150234868	1	18,38	97
SB7805DM-13	7314150235032	1	18,38	97
SB7805DM-14	7314150235049	1	19,15	97
SB7805DM-15	7314150235056	1	20,10	97
SB7805DM-16	7314150235063	1	20,66	97
SB7805DM-17	7314150235070	1	20,66	97
SB7805DM-18	7314150235087	1	20,66	97
SB7805DM-19	7314150235094	1	20,66	97
SB7805DM-21	7314150235101	1	22,87	97
SB7805DM-22	7314150235117	1	23,06	97
SB7805DM-23	7314150327614	1	23,11	97
SB7805DM-24	7314150235124	1	23,75	97
SB7805DM-26	7314150240197	1	23,75	97
SB7805DM-27	7314150235131	1	26,25	97
SB7805DM-30	7314150235148	1	28,04	97
SB7805DM-32	7314150240203	1	28,66	97
SB7805DM-34	7314150521852	1	22,33	97
SB7805SM-10	7314150235155	1	18,68	95
SB7805SM-11	7314150524501	1	12,89	95
SB7805SM-12	7314150235162	1	18,68	95
SB7805SM-13	7314150235179	1	18,68	95



SB7805SM-14	7314150235193	1	19,45	95
SB7805SM-15	7314150235216	1	20,45	95
SB7805SM-16	7314150240210	1	20,95	95
SB7805SM-17	7314150235223	1	20,95	95
SB7805SM-18	7314150235230	1	20,95	95
SB7805SM-19	7314150235247	1	20,95	95
SB7805SM-20	7314150240227	1	21,70	95
SB7805SM-21	7314150235254	1	23,28	95
SB7805SM-22	7314150235261	1	23,46	95
SB7805SM-23	7314150240234	1	24,17	95
SB7805SM-24	7314150235278	1	24,17	95
SB7805SM-25	7314150240241	1	24,17	95
SB7805SM-26	7314150240258	1	24,17	95
SB7805SM-27	7314150235285	1	26,67	95
SB7805SM-28	7314150240265	1	24,90	95
SB7805SM-29	7314150240272	1	26,59	95
SB7805SM-30	7314150235292	1	28,49	95
SB7805SM-32	7314150235308	1	30,79	95
SB7805SM-34	7314150498284	1	33,65	95
SB7807H	7314150467297	1	48,62	184
SB7808H	7314150467303	1	48,62	184
SB7809H	7314150467341	1	53,84	184
SB7809M-10	7314153004185	1	15,02	100
SB7809M-10-120	7314150555574	1	20,27	101
SB7809M-12	7314153004208	1	16,05	100
SB7809M-12-120	7314150555581	1	24,83	101
SB7809M-14	7314153004215	1	16,45	100
SB7809M-14-120	7314150555598	1	25,25	101
SB7809M-17	7314153004222	1	16,97	100
SB7809M-17-120	7314150555604	1	25,68	101
SB7809M-19	7314153004239	1	17,23	100
SB7809M-19-120	7314150555611	1	26,19	101
SB7809M-4	7314150313952	1	14,60	100
SB7809M-4-120	7314150555650	1	20,13	101
SB7809M-5	7314153004109	1	14,60	100
SB7809M-5-100*	7314150313969	1	19,68	101
SB7809M-5-120	7314150555608	1	20,25	101
SB7809M-5-180	7314153004116	1	23,32	101
SB7809M-6	7314153004123	1	14,60	100
SB7809M-6-120	7314150555543	1	20,50	101
SB7809M-7	7314153004130	1	14,60	100
SB7809M-7-120	7314150555567	1	20,75	101
SB7809M-8	7314153004154	1	15,71	100
SB7809M-8-120	7314153004161	1	21,44	101
SB7809M-9	7314153004178	1	15,71	100
SB7809TORX-T20	7314153004017	1	16,38	100
SB7809TORX-T25	7314153004024	1	16,38	100
SB7809TORX-T27	7314153004031	1	16,38	100
SB7809TORX-T30	7314153004048	1	16,38	100
SB7809TORX-T40	7314153004055	1	18,94	100
SB7809TORX-T45	7314153004062	1	18,94	100
SB7809TORX-T50	7314153004079	1	18,94	100
SB7809TORX-T55	7314153004086	1	23,42	100
SB7809TORX-T60	7314153004093	1	23,42	100
SB81-SET1	7314150538942	8	36,67	102
SB8150-1/2	7314150105014	1	67,63	101
SB8150QR	7314150548095	1	28,12	101
SB8150RN-1/2	7314150105007	1	65,33	101
SB8154-11	7314150472178	1	24,73	98
SB8157-10	7314150474073	1	98,60	97
SB8157-15	7314150472468	1	57,84	97
SB8157-24	7314150474080	1	99,68	97
SB8157-36	7314150474097	1	137,83	97
SB8158-10	7314150488780	1	35,73	97
SB8158-15	7314150488797	1	45,55	97
SB8160-10	7314150472185	1	20,45	98
SB8160-3	7314150472192	1	16,91	98
SB8160-5	7314150472208	1	11,40	98
SB8166	7314150472154	1	36,82	98
SB8171	7314150479016	1	20,45	98
SB8172	7314150479023	1	24,03	99
SBA6700DM-10	7314150235575	1	5,97	82
SBA6700DM-11	7314150241750	1	5,97	82
SBA6700DM-12	7314150241767	1	5,97	82
SBA6700DM-13	7314150241774	1	5,97	82
SBA6700DM-14	7314150241781	1	5,97	82
SBA6700DM-5	7314150255054	1	5,97	82
SBA6700DM-5.5	7314150241798	1	5,97	82
SBA6700DM-6	7314150241804	1	5,97	82
SBA6700DM-7	7314150241811	1	5,97	82
SBA6700DM-8	7314150241828	1	5,97	82
SBA6700DM-9	7314150241835	1	5,97	82
SBA6709M-2.5	7314150254835	1	33,77	86
SBA6709M-3	7314150254828	1	33,77	86
SBA6709M-4	7314150254811	1	33,77	86
SBA6709M-5	7314150254804	1	33,60	86
SBA6709M-6	7314150254798	1	33,60	86
SBA6709Z-1/8	7314150254781	1	33,60	86
SBA6709Z-3/16	7314150254774	1	33,60	86



SBA6709Z-5/32	7314150254767	1	33,60	86
SBA6709Z-9/64	7314150254750	1	33,60	86
SBA6800DM-10	7314150250172	1	13,11	82
SBA6800DM-11	7314150250189	1	13,11	82
SBA6800DM-12	7314150250196	1	13,11	82
SBA6800DM-13	7314150250202	1	13,11	82
SBA6800DM-14	7314150250219	1	13,11	82
SBA6800DM-4	7314150250226	1	13,11	82
SBA6800DM-5	7314150250233	1	13,11	82
SBA6800DM-5.5	7314150250240	1	13,11	82
SBA6800DM-6	7314150250257	1	13,11	82
SBA6800DM-7	7314150250264	1	13,11	82
SBA6800DM-8	7314150250271	1	13,11	82
SBA6800DM-9	7314150250288	1	13,11	82
SBA6800DZ-1/2	7314150250295	1	15,69	83
SBA6800DZ-1/4	7314150250301	1	15,69	83
SBA6800DZ-11/32	7314150250318	1	15,69	83
SBA6800DZ-3/16	7314150250325	1	15,69	83
SBA6800DZ-3/8	7314150250332	1	15,69	83
SBA6800DZ-5/16	7314150250349	1	15,69	83
SBA6800DZ-7/16	7314150250356	1	15,69	83
SBA6800DZ-7/32	7314150250363	1	15,69	83
SBA6800DZ-9/16	7314150250370	1	15,69	83
SBA6800DZ-9/32	7314150250387	1	15,69	83
SBA7400DM-10	7314150241941	1	8,35	89
SBA7400DM-11	7314150241958	1	8,35	89
SBA7400DM-12	7314150241965	1	8,35	89
SBA7400DM-13	7314150241972	1	8,35	89
SBA7400DM-14	7314150241989	1	8,35	89
SBA7400DM-15	7314150241996	1	8,47	89
SBA7400DM-16	7314150242009	1	8,47	89
SBA7400DM-17	7314150242016	1	8,47	89
SBA7400DM-18	7314150242023	1	8,47	89
SBA7400DM-19	7314150242030	1	8,47	89
SBA7400DM-20	7314150242047	1	8,47	89
SBA7400DM-21	7314150242054	1	8,56	89
SBA7400DM-22	7314150242061	1	8,56	89
SBA7400DM-6	7314150242078	1	8,35	88
SBA7400DM-7	7314150242085	1	8,35	88
SBA7400DM-8	7314150242092	1	8,35	89
SBA7400DM-9	7314150242108	1	8,35	89
SBA7400DZ-1/2	7314150254705	1	9,20	89
SBA7400DZ-1/4	7314150242115	1	9,05	89
SBA7400DZ-11/16	7314150242122	1	9,31	89
SBA7400DZ-13/16	7314150242139	1	9,31	89
SBA7400DZ-17/32	7314150242146	1	9,20	89
SBA7400DZ-19/32	7314150242153	1	9,20	89
SBA7400DZ-3/4	7314150242160	1	9,31	89
SBA7400DZ-3/8	7314150242177	1	9,05	89
SBA7400DZ-5/16	7314150242184	1	9,05	89
SBA7400DZ-5/8	7314150242191	1	9,31	89
SBA7400DZ-7/16	7314150242207	1	9,20	89
SBA7400DZ-7/8	7314150242214	1	9,31	89
SBA7400DZ-9/16	7314150242221	1	9,20	89
SBA7402DM-10	7314150250394	1	16,07	89
SBA7402DM-11	7314150250400	1	16,07	89
SBA7402DM-12	7314150250417	1	16,07	89
SBA7402DM-13	7314150250424	1	16,07	89
SBA7402DM-14	7314150250431	1	16,76	89
SBA7402DM-15	7314150250448	1	16,76	89
SBA7402DM-16	7314150250455	1	16,76	89
SBA7402DM-17	7314150250462	1	17,85	89
SBA7402DM-18	7314150250479	1	17,85	89
SBA7402DM-19	7314150250486	1	17,85	89
SBA7402DM-7	7314150250493	1	16,05	89
SBA7402DM-8	7314150250509	1	16,05	89
SBA7402DM-9	7314150250516	1	16,07	89
SBA7402DZ-1/2	7314150250523	1	17,93	90
SBA7402DZ-1/4	7314150250530	1	17,93	90
SBA7402DZ-11/16	7314150250547	1	17,93	90
SBA7402DZ-13/16	7314150250554	1	17,93	90
SBA7402DZ-19/32	7314150250561	1	17,93	90
SBA7402DZ-3/4	7314150250578	1	17,93	90
SBA7402DZ-3/8	7314150250585	1	17,93	90
SBA7402DZ-5/16	7314150250592	1	17,93	90
SBA7402DZ-5/8	7314150250608	1	17,93	90
SBA7402DZ-7/16	7314150250615	1	17,93	90
SBA7402DZ-7/8	7314150250622	1	17,93	90
SBA7402DZ-9/16	7314150250639	1	17,93	90
SBA7402SM-10	7314150561124	1	15,86	90
SBA7402SM-11	7314150561131	1	15,86	90
SBA7402SM-12	7314150561148	1	15,86	90
SBA7402SM-13	7314150561155	1	15,86	90
SBA7402SM-14	7314150561162	1	16,59	90
SBA7402SM-15	7314150561179	1	16,59	90
SBA7402SM-16	7314150561186	1	16,59	90
SBA7402SM-17	7314150561193	1	17,65	90
SBA7402SM-18	7314150561209	1	17,65	90
SBA7402SM-19	7314150561216	1	17,65	90

\* Hasta agotar existencias



SBA7402SM-20	7314150561223	1	18,59	90
SBA7402SM-22	7314150561230	10	18,59	90
SBA7402SM-6	7314150561247	1	15,36	90
SBA7402SM-7	7314150561254	1	15,36	90
SBA7402SM-8	7314150561261	1	15,36	90
SBA7402SM-9	7314150561278	1	15,36	90
SBC110-65	7314150456246	1	2,56	561
SBE-8135TB	7314150320424	1	9,42	205
SBE-8145TB	7314150320431	1	12,18	205
SBE-8150TB	7314150320448	1	14,00	205
SBE-8155TB	7314150320455	1	16,36	205
SBE-8610TB	7314150320493	1	14,88	205
SBE-8620TB	7314150320509	1	16,45	205
SBE-8810TB	7314150320530	1	13,41	205
SBE-8820TB	7314150320547	1	18,72	205
SBE-8915TB	7314150320585	1	11,85	206
SBE-8920TB	7314150320592	1	12,04	206
SBE-8925TB	7314150320608	1	12,76	206
SBE-8930TB	7314150320622	1	14,56	206
SBE-8940TB	7314150320639	1	16,37	206
SBK6701M-10	7314150445233	1	7,57	179
SBK6701M-11	7314150445240	1	7,57	179
SBK6701M-12	7314150445264	1	9,38	179
SBK6701M-13	7314150445271	1	9,38	179
SBK6701M-14	7314150445288	1	9,38	179
SBK6701M-6	7314150445196	1	7,57	179
SBK6701M-7	7314150445202	1	7,57	179
SBK6701M-8	7314150445219	1	7,57	179
SBK6701M-9	7314150445226	1	7,57	179
SBK7401M-10	7314150445325	1	8,66	180
SBK7401M-11	7314150445332	1	8,66	180
SBK7401M-12	7314150445349	1	8,66	180
SBK7401M-13	7314150445356	1	8,66	180
SBK7401M-14	7314150445363	1	8,66	180
SBK7401M-15	7314150445370	1	8,66	180
SBK7401M-16	7314150445387	1	8,66	180
SBK7401M-17	7314150445394	1	8,66	180
SBK7401M-18	7314150445400	1	10,18	180
SBK7401M-19	7314150445417	1	10,18	180
SBK7401M-20	7314150445424	1	10,48	180
SBK7401M-21	7314150445431	1	10,48	180
SBK7401M-22	7314150445448	1	10,94	180
SBK7401M-24	7314150445455	1	11,03	180
SBK7401M-7	7314150445295	1	8,66	180
SBK7401M-8	7314150445301	1	8,66	180
SBK7401M-9	7314150445318	1	8,66	180
SBK7764D	7314150447800	1	23,62	184
SBK7801M-10	7314150445486	1	10,35	182
SBK7801M-11	7314150445493	1	10,35	182
SBK7801M-12	7314150445509	1	10,35	182
SBK7801M-13	7314150445516	1	10,35	182
SBK7801M-14	7314150445523	1	10,71	182
SBK7801M-15	7314150445530	1	10,71	182
SBK7801M-16	7314150445547	1	10,71	182
SBK7801M-17	7314150445554	1	11,72	182
SBK7801M-18	7314150445561	1	11,72	182
SBK7801M-19	7314150445578	1	11,72	182
SBK7801M-20	7314150445585	1	11,72	182
SBK7801M-21	7314150445592	1	11,72	182
SBK7801M-22	7314150445608	1	12,57	182
SBK7801M-23	7314150445615	1	12,61	182
SBK7801M-24	7314150445622	1	12,61	182
SBK7801M-25	7314150445639	1	12,61	182
SBK7801M-26	7314150445646	1	12,61	182
SBK7801M-27	7314150445653	1	15,66	182
SBK7801M-28	7314150450763	1	14,99	182
SBK7801M-29	7314150450770	1	15,07	182
SBK7801M-30	7314150445660	1	17,03	182
SBK7801M-32	7314150445677	1	24,40	182
SBK7801M-34	7314150445684	1	26,52	182
SBK7801M-36	7314150445691	1	26,52	182
SBK7801M-8	7314150445462	1	8,22	182
SBK7801M-9	7314150445479	1	8,22	182
SBK7801Z-1	7314150448036	1	14,35	183
SBK7801Z-1.1/16	7314150448142	1	15,47	183
SBK7801Z-1.1/2	7314150448203	1	35,73	183
SBK7801Z-1.1/4	7314150448166	1	26,96	183
SBK7801Z-1.1/8	7314150448159	1	16,40	183
SBK7801Z-1.3/8	7314150448180	1	31,19	183
SBK7801Z-1.5/16	7314150448173	1	31,19	183
SBK7801Z-1.7/16	7314150448197	1	31,19	183
SBK7801Z-1/2	7314150448067	1	11,33	183
SBK7801Z-11/16	7314150448098	1	11,70	183
SBK7801Z-13/16	7314150448111	1	11,87	183
SBK7801Z-15/16	7314150448135	1	13,80	183
SBK7801Z-3/4	7314150448104	1	11,70	183
SBK7801Z-3/8	7314150448043	1	11,33	183
SBK7801Z-5/8	7314150448081	1	11,70	183
SBK7801Z-7/16	7314150448050	1	11,33	183



# SBK7801Z-7/8



SBK7801Z-7/8	7314150448128	1	11,87	183
SBK7801Z-9/16	7314150448074	1	11,70	183
SBK7806M-10	7314150447831	1	13,54	182
SBK7806M-11	7314150447862	1	13,54	182
SBK7806M-12	7314150447879	1	13,54	182
SBK7806M-13	7314150447886	1	13,54	182
SBK7806M-14	7314150447893	1	13,54	182
SBK7806M-15	7314150447909	1	13,70	182
SBK7806M-16	7314150447916	1	13,70	182
SBK7806M-17	7314150447923	1	13,70	182
SBK7806M-18	7314150447930	1	13,74	182
SBK7806M-19	7314150447947	1	13,74	182
SBK7806M-21	7314150447954	1	13,74	182
SBK7806M-22	7314150447961	1	13,74	182
SBK7806M-23	7314150447978	1	14,35	182
SBK7806M-24	7314150447985	1	14,16	182
SBK7806M-27	7314150447992	1	16,41	182
SBK7806M-30	7314150448005	1	18,48	182
SBK7806M-32	7314150448012	1	21,48	182
SBK7806M-36	7314150448029	1	24,76	182
SBK7806Z-1	7314150448401	1	16,88	183
SBK7806Z-1.1/16	7314150448418	1	17,98	183
SBK7806Z-1.1/2	7314150448470	1	41,16	183
SBK7806Z-1.1/4	7314150448432	1	31,00	183
SBK7806Z-1.1/8	7314150448425	5	20,26	183
SBK7806Z-1.3/8	7314150448456	5	35,91	183
SBK7806Z-1.5/16	7314150448449	1	35,91	183
SBK7806Z-1.7/16	7314150448463	5	35,91	183
SBK7806Z-1/2	7314150448326	10	14,83	183
SBK7806Z-11/16	7314150448357	1	14,99	183
SBK7806Z-13/16	7314150448371	1	15,04	183
SBK7806Z-15/16	7314150448395	1	15,50	183
SBK7806Z-3/4	7314150448364	1	15,04	183
SBK7806Z-3/8	7314150448302	10	14,83	183
SBK7806Z-5/8	7314150448340	5	14,99	183
SBK7806Z-7/16	7314150448319	10	14,83	183
SBK7806Z-7/8	7314150448388	1	15,04	183
SBK7806Z-9/16	7314150448333	10	14,83	183
SBK8160D-1	7314150447770	1	15,30	184
SBK8160D-2	7314150447787	1	18,64	184
SBK8160D-3	7314150447794	1	29,11	184
SBK8901M-17	7314150448487	1	18,14	186
SBK8901M-18	7314150448494	1	18,14	186
SBK8901M-19	7314150448500	1	17,85	186
SBK8901M-21	7314150448517	1	17,85	186
SBK8901M-22	7314150448524	1	17,85	186
SBK8901M-23	7314150448531	1	18,14	186
SBK8901M-24	7314150448548	1	17,85	186
SBK8901M-27	7314150448555	1	17,85	186
SBK8901M-28	7314150448562	1	18,24	186
SBK8901M-29	7314150448579	1	18,52	186
SBK8901M-30	7314150448586	1	18,90	186
SBK8901M-32	7314150448593	1	19,57	186
SBK8901M-33	7314150448609	1	20,58	186
SBK8901M-34	7314150448616	1	20,78	186
SBK8901M-36	7314150448623	1	21,83	186
SBK8901M-38	7314150448630	1	22,63	186
SBK8901M-41	7314150448647	1	25,36	186
SBK8901M-46	7314150448654	1	29,27	186
SBK8901M-50	7314150448661	1	34,08	186
SBK8901M-55	7314150448678	1	40,92	186
SBK8901M-60	7314150448685	1	46,31	186
SBK8964D	7314150447817	1	12,11	184
SBS19-TH10	7314150190072	1	5,87	94
SBS19-TH11	7314150190089	1	5,87	94
SBS19-TH12	7314150190096	1	5,87	94
SBS19-TH13	7314150190102	1	5,87	94
SBS19-TH14	7314150190119	1	6,06	94
SBS19-TH15	7314150190126	1	6,06	94
SBS19-TH16	7314150190133	1	6,06	94
SBS19-TH17	7314150190140	1	6,92	94
SBS19-TH18	7314150190157	100	6,92	94
SBS19-TH19	7314150190164	1	6,92	94
SBS19-TH21	7314150190256	100	7,61	94
SBS19-TH22	7314150190188	1	7,61	94
SBS19-TH24	7314150190195	1	8,19	94
SBS19-TH75	7314150190201	1	9,99	94
SBS19-THR	7314150190218	50	37,47	93
SBS20-11*	7314153009159	1	6,50	43
SBS20-12*	7314153009166	1	7,13	43
SBS20-13*	7314153009173	1	7,16	43
SBS20-14*	7314153009180	1	7,85	43
SBS20-15*	7314153009197	1	8,06	43
SBS20-16	7314153009203	1	8,63	43
SBS20-18*	7314153009227	1	8,65	43
SBS20-20*	7314153009241	1	11,89	43
SBS20-21*	7314153009258	1	12,46	43
SBS20-22*	7314153009265	1	13,68	43
SBS20-7*	7314153009111	1	5,67	43



SBS20-8*	7314153009128	1	5,87	43
SBS20-9*	7314153009135	1	6,00	43
SBS39MH	7314150557615	24	31,42	66
SBSL25	7314153015853	5	47,62	66
SBSL25L	7314150557479	10	48,18	66
SC127	7314150121984	10	13,21	566
SC127S	7314150121991	10	13,64	566
SC127V	7314150121847	5	24,50	490
SC140	7314150122004	10	13,89	566
SC140C	7314150122011	10	14,56	566
SC150NG	7314150122028	10	19,30	566
SC150NGV	7314150121854	5	37,81	490
SC2RM-13-17	7314150265350	10	38,25	107
SC2RM-15-17	7314150265367	10	38,87	107
SC2RM-19-22	7314150181384	10	40,10	107
SC2RM-27-30	7314150265343	1	72,18	107
SC335M-17	7314150344314	1	10,48	54
SC335M-19	7314150344321	1	15,22	54
SC335M-22	7314150344338	1	20,55	54
SC335M-24	7314150344345	1	22,41	54
SC335M-32	7314150344376	1	39,10	54
SC335M-36	7314150344383	1	44,42	54
SC335M-41	7314150344390	1	60,09	54
SC335M-46	7314150344406	1	75,84	54
SCB140	7314150297351	10	27,33	565
SCB140G	7314150297368	10	29,99	565
SCRAPER-SET2	7311518228613	1	111,25	536
SE-15-24	7311518029838	5	8,63	618
SE-15-30	7311518029821	5	9,17	618
SE-15-30-23	7311518029845	5	9,25	618
SE-15-32	7311518249168	5	10,11	618
SE-15-36	7311518141202	5	10,76	618
SE-15-36-23	7311518258276	5	10,71	618
SE-16-21	7311518029807	5	8,79	618
SE-16-21-23	7311518273934	5	7,59	618
SH-407	7314150389827	1	4,64	582
SH-427-700	7314150349074	10	6,15	582
SH-428-700	7314150349081	10	8,88	582
SH-485W	7314150358021	1	9,55	580
SH-485W-PLATES	7314150358038	1	7,59	580
SH-486-493-495	7314150349098	10	6,15	582
SH-486F493F495F	7314150349104	10	8,88	582
SH-486W	7314150358014	1	8,94	581
SH-488-2000	7314150346912	10	13,40	582
SH-488-34	7314150349036	10	19,41	582
SH-488-56	7314150349043	10	21,19	582
SH-488F-2000	7314150346950	10	16,53	582
SH-488F-34	7314150349050	1	20,50	582
SH-488F-56	7314150349067	1	21,87	582
SH-491-34	7314150374298	12	18,82	582
SH-491-56	7314150374304	12	29,93	582
SH-FCP-860	7311518324421	1	34,64	587
SH-FCS-810	7311518140540	1	27,87	587
SH-FCS-860	7311518140557	1	32,00	587
SH-FGS-1.8-810	7311518327828	1	20,83	587
SH-FGS-600	7311518140649	1	22,08	587
SH-FGS-700	7311518140656	12	24,10	587
SH-FGS-800	7311518140663	1	28,71	587
SH-HFGPS-400FG	7311518282301	1	19,91	587
SH-HGPS-360	7311518140618	12	14,92	587
SH-HGPS-380	7311518140625	1	16,01	587
SH-HGPS-400	7311518207618	1	17,66	587
SH-HUS-380	7311518140502	1	16,01	587
SH-HUS-500	7311518140519	1	21,00	587
SH-HUS-650	7311518140526	1	23,74	587
SH-MCS-800	7311518140595	1	28,71	587
SH-MES-900	7311518140601	12	27,62	587
SH-MES-900FG	7311518282318	12	41,35	587
SH-MES-F-900	7311518141554	12	21,52	587
SH-PAGS-900	7311518327866	1	21,19	587
SH-PAGS-900FG	7311518326944	1	49,02	587
SH-SUS-800	7311518140809	12	28,71	587
SHARP-INS	7314150197897	100	11,12	554
SHARP-X	7311518264895	10	23,95	622
SHARP-X-DISP	7311518264901	1	718,21	622
SL24	7314150128389	30	44,51	66
SL25	7314153013422	20	44,11	65
SL25AF	7314150180141	20	44,11	67
SL25L	7314150256570	10	61,98	66
SL34	7314150409181	6	85,82	72
SL65	7314150444137	6	89,12	67
SL91*	7314150444151	4	182,67	65
SLX 17	7314153015785	1	277,96	79
SLX 17AF	7314150137558	1	277,96	79
SLX17-CASE	7314150321254	1	53,01	107
SLX20	7314150548989	2	279,13	79
SP120	7314150312474	1	27,60	99
SP120XL	7314150313594	1	13,14	99
SPAR-CASE-A4	7314150263523	1	19,89	107



			€	
SPAR-CASE-A6	7314150263547	1	14,03	107
SPAR-CASE-A7	7314150263554	1	13,34	107
SQZ-MINI	7314150186280	24	10,01	569
SQZ-MINI-BLADE	7314150190348	1	5,38	569
SQZ150003	7314153013477	6	24,83	567
SQZ150003-HSBL*	7314153015389	6	14,79	568
SR1000-E	7314150302918	20	15,43	532
SR1000-MM	7314150302857	20	15,43	532
SR150-E	7314150302864	12	2,13	532
SR150-MM	7314150302819	12	2,13	532
SR200-E	7314150302871	12	2,79	532
SR200-MM	7314150302826	12	2,79	532
SR300-E	7314150302888	12	3,75	532
SR300-MM	7314150302833	12	3,75	532
SR600-E	7314150302901	20	7,33	532
SR600-MM	7314150302840	20	7,33	532
SS001-100	7314150404384	1	93,64	514
SS001-150	7314150404377	1	105,53	514
SS001-200	7314150404391	1	153,71	514
SS001-250	7314150404407	1	189,80	514
SS001-300	7314150404414	1	251,31	514
SS001-375	7314150404421	1	390,25	514
SS001-450	7314150404438	1	461,24	514
SS001-600	7314150404445	1	773,14	514
SS002-10	7314150404483	1	20,95	514
SS002-11	7314150404490	1	23,40	514
SS002-12	7314150404506	1	24,64	514
SS002-13	7314150404513	1	25,86	514
SS002-14	7314150404520	1	27,10	514
SS002-15	7314150404537	1	28,34	514
SS002-16	7314150404551	1	29,57	514
SS002-17	7314150404568	1	30,80	514
SS002-19	7314150404575	1	32,03	514
SS002-21	7314150404582	1	39,91	514
SS002-22	7314150404599	1	43,11	514
SS002-24	7314150404605	1	48,53	514
SS002-27	7314150404612	1	70,23	514
SS002-32	7314150404629	1	95,97	514
SS002-6	7314150404469	1	13,41	514
SS002-6-2	7314150404703	1	160,17	514
SS002-7	7314150445790	1	19,63	514
SS002-8	7314150404476	1	16,87	514
SS002-9-2	7314150407910	1	236,55	514
SS003-10	7314150404643	1	18,74	514
SS003-11	7314150404650	1	21,93	514
SS003-12	7314150404667	1	24,03	514
SS003-14	7314150404681	1	25,86	514
SS003-16	7314150404704	1	28,34	514
SS003-18	7314150404711	1	30,30	514
SS003-20	7314150404728	1	32,03	514
SS003-22	7314150404735	1	33,51	514
SS003-24	7314150404742	1	35,11	514
SS003-25	7314150404759	1	41,88	514
SS003-26	7314150404766	1	44,36	514
SS003-28	7314150404773	1	45,58	514
SS003-30	7314150404780	1	54,21	514
SS003-8	7314150404636	1	17,24	514
SS011-0507*	7314150404797	1	27,80	514
SS011-0607*	7314150404803	1	28,43	514
SS011-0809*	7314150404810	1	29,21	514
SS011-0810*	7314150404827	1	29,50	514
SS011-0911*	7314150404834	1	31,32	515
SS011-1012*	7314150404858	1	31,82	515
SS011-11-3*	7314150419142	1	800,30	515
SS011-1214*	7314150404865	1	34,75	515
SS011-1417*	7314150404872	1	40,17	515
SS011-1618*	7314150404889	1	45,07	515
SS011-1719*	7314150404896	1	49,30	515
SS011-1722*	7314150404902	1	65,59	515
SS011-2224*	7314150404919	1	75,14	515
SS011-2427*	7314150404926	1	95,42	515
SS011-2430*	7314150404940	1	135,72	515
SS011-3032*	7314150404957	1	164,38	515
SS011-9-3*	7314150419135	1	633,20	515
SS210-10	7314150405343	1	23,87	515
SS210-11	7314150405350	1	26,52	515
SS210-12	7314150405367	1	29,99	515
SS210-13	7314150405374	1	31,99	515
SS210-14	7314150405381	1	33,20	515
SS210-4	7314150405268	1	13,73	515
SS210-4.5	7314150405275	1	13,73	515
SS210-5	7314150405282	1	13,73	515
SS210-5.5	7314150405299	1	13,73	515
SS210-6	7314150405305	1	16,53	515
SS210-7	7314150405312	1	18,00	515
SS210-8	7314150405329	1	20,13	515
SS210-9	7314150405336	1	22,53	515
SS220-10	7314150404995	1	36,66	515
SS220-11	7314150405008	1	38,66	515

			€	
SS220-12	7314150405022	1	41,32	515
SS220-13	7314150405039	1	42,65	515
SS220-14	7314150405053	1	44,66	515
SS220-15	7314150405060	1	47,99	515
SS220-16	7314150405077	1	50,00	515
SS220-17	7314150405084	1	51,98	515
SS220-18	7314150405091	1	54,65	515
SS220-19	7314150405114	1	57,32	515
SS220-20	7314150405121	1	59,99	515
SS220-21	7314150405138	1	61,33	515
SS220-22	7314150405145	1	62,64	515
SS220-23	7314150405152	1	67,98	515
SS220-24	7314150405176	1	71,99	515
SS220-25	7314150405183	1	75,98	515
SS220-26	7314150405190	1	86,64	515
SS220-27	7314150405206	1	89,31	515
SS220-28	7314150405213	1	95,98	515
SS220-29	7314150405220	1	99,97	515
SS220-30	7314150405237	1	105,32	515
SS220-31	7314150405244	1	115,97	515
SS220-32	7314150405251	1	115,97	515
SS220-8	7314150404964	1	34,00	515
SS220-9	7314150404988	1	35,32	515
SS224-17	7314150405398	1	74,64	515
SS224-19	7314150405404	1	77,32	515
SS224-22	7314150405411	1	83,98	515
SS224-24	7314150405428	1	94,64	515
SS224-27	7314150405435	1	99,97	515
SS224-30	7314150405442	1	115,97	515
SS224-32	7314150405459	1	131,97	515
SS224-34	7314150405466	1	145,30	515
SS224-36	7314150405473	1	153,31	515
SS224-41	7314150405480	1	179,96	515
SS224-46	7314150405497	1	213,28	515
SS224-50	7314150405503	1	238,61	515
SS224-55	7314150405510	1	339,92	515
SS224-60	7314150405527	1	398,57	515
SS224-65	7314150405534	1	506,54	515
SS234-16-100	7314150405572	1	53,32	515
SS234-16-200	7314150405589	1	86,64	515
SS234-16-250	7314150405602	1	99,97	515
SS234-24-100	7314150405619	1	115,97	515
SS234-24-200	7314150405626	1	126,63	515
SS234-24-250	7314150405633	1	174,28	515
SS236-08-80	7314150405718	1	63,63	515
SS236-16-80	7314150405701	1	86,64	515
SS236-24-110	7314150405725	1	153,31	515
SS238-08-250	7314150405657	1	117,31	516
SS238-16-250	7314150405640	1	118,64	516
SS238-24-350	7314150405664	1	166,62	516
SS242-08-200	7314150405558	1	153,31	516
SS242-16-245	7314150405541	1	159,96	516
SS242-24-320	7314150405565	1	313,26	516
SS243-08	7314150405688	1	56,62	516
SS243-16	7314150405671	1	132,73	516
SS243-24	7314150405695	1	336,30	516
SS324-1.5*	7314150405732	1	4,34	517
SS324-10*	7314150405824	1	13,30	517
SS324-2*	7314150405749	1	4,34	517
SS324-2.5*	7314150405756	1	4,34	517
SS324-3*	7314150405763	1	4,66	517
SS324-4*	7314150405770	1	5,10	517
SS324-5*	7314150405787	1	6,21	517
SS324-6*	7314150405794	1	6,88	517
SS324-8*	7314150405817	1	10,75	517
SS325-10*	7314150405886	1	11,65	517
SS325-12*	7314150405879	1	14,41	517
SS325-2.5*	7314150405909	1	5,55	517
SS325-3*	7314150405862	1	5,55	517
SS325-3.5*	7314150405923	1	7,40	517
SS325-4*	7314150405848	1	6,10	517
SS325-4.5*	7314150405930	1	9,86	517
SS325-5*	7314150405893	1	6,65	517
SS325-6*	7314150405855	1	8,87	517
SS325-7*	7314150405916	1	9,43	517
SS325-8*	7314150405831	1	9,98	517
SS400-160	7314150405978	1	61,73	518
SS400-180	7314150405985	1	77,32	518
SS400-200	7314150405992	1	98,64	518
SS402-160	7314150406005	1	66,25	518
SS402-200	7314150406012	1	72,12	518
SS406-160	7314150406029	1	66,65	518
SS406-200	7314150406036	1	76,92	518
SS410-250	7314150406043	1	102,64	518
SS410-300	7314150406050	1	159,96	518
SS412-200	7314150406067	1	99,97	518
SS415-225	7314150406074	1	153,31	518
SS502-1000-FB	7314150406081	1	113,31	518
SS502-1500-FB	7314150406098	1	159,96	518

\* Hasta agotar existencias





# SS502-2000-FB



SS502-2000-FB	7314150406104	1	205,29	518
SS502-2500-FB	7314150406111	1	258,60	518
SS502-3000-FB*	7314150406128	1	306,59	518
SS502-3600-FB	7314150406135	1	366,58	518
SS506-1100-FB	7314150406197	1	131,97	518
SS506-200-FB	7314150406142	1	38,66	518
SS506-300-FB	7314150406159	1	51,98	518
SS506-500-FB	7314150406166	1	55,99	518
SS506-700-FB	7314150406173	1	99,97	518
SS506-900-FB	7314150406180	1	115,97	518
SS603-15-500	7314150406203	1	82,65	518
SS603-19-500	7314150406210	1	114,64	518
SS603-20-500	7314150406227	1	117,85	518
SS603-23-500	7314150406234	1	138,70	518
SS603-23-800	7314150406258	1	213,28	518
SS603-25-600	7314150406241	1	201,44	518
SS603-30-1000	7314150406265	1	466,55	518
SS610-16-160	7314150406272	1	39,99	518
SS610-18-200	7314150406289	1	57,99	518
SS610-24-300	7314150406296	1	181,29	518
SS610-25-400	7314150406302	1	283,93	518
SS610-30-500	7314150406319	1	383,91	518
SUP-20-LAM	7311518258351	4	58,35	551
SUS-2.0-800	7311518123451	4	86,02	586
SW65	7314150442898	6	95,48	67
SW79	7314150442904	4	180,35	65
SW91*	7314150442942	4	196,27	65
TAH08-10	7314150305087	1	6,66	463
TAH08-11	7314150305094	1	6,66	463
TAH08-12	7314150305100	1	6,66	463
TAH08-13	7314150305117	1	6,66	463
TAH08-5.5	7314150305032	1	6,66	463
TAH08-6	7314150305049	1	6,66	463
TAH08-7	7314150305056	1	6,66	463
TAH08-8	7314150305063	1	6,66	463
TAH08-9	7314150305070	1	6,66	463
TAH08-H3	7314150305124	1	8,76	464
TAH08-H4	7314150305131	1	8,76	464
TAH08-H5	7314150305148	1	8,76	464
TAH08-H6	7314150305155	1	8,76	464
TAH08-H8	7314150305162	1	8,76	464
TAH08-PH1	7314150305179	1	9,68	464
TAH08-PH2	7314150305186	1	9,68	464
TAH08-PH3	7314150305193	1	9,68	464
TAH08-T10	7314150305223	1	10,90	464
TAH08-T15	7314150305230	1	10,90	464
TAH08-T20	7314150305247	1	10,90	464
TAH08-T25	7314150305254	1	11,26	464
TAH08-T27	7314150305261	1	11,26	464
TAH08-T30	7314150305278	1	11,26	464
TAH08-T40	7314150305285	1	11,26	464
TAH08-T8	7314150305209	1	10,90	464
TAH08-T9	7314150305216	1	10,90	464
TAH1-100-06-2-4	7314150307531	1	20,55	472
TAH1-110-08-1-2*	7314150437825	1	22,74	472
TAH1-143-12-1-2	7314150307548	1	26,30	472
TAH1-160-08-1-2*	7314150437818	1	20,39	472
TAH1-170-08-1-2*	7314150437801	1	21,28	472
TAH1-210-06-2-2	7314150307555	1	23,70	472
TAH1-210-08-1-2*	7314150437795	1	25,14	472
TAH1-230-06-2-2	7314150307562	1	12,95	472
TAH1-230-08-1-2*	7314150437788	1	26,62	472
TAH111M-10	7314150308538	1	14,76	461
TAH111M-11	7314150308545	1	15,00	461
TAH111M-12	7314150308552	1	15,42	461
TAH111M-13	7314150308569	1	15,45	461
TAH111M-14	7314150308576	1	15,50	461
TAH111M-15	7314150308583	1	16,03	461
TAH111M-16	7314150308590	1	16,33	461
TAH111M-17	7314150308606	1	17,48	461
TAH111M-18	7314150308613	1	19,36	461
TAH111M-19	7314150308620	1	20,20	461
TAH111M-20	7314150308637	1	20,78	461
TAH111M-21	7314150308644	1	22,47	461
TAH111M-22	7314150308651	1	22,65	461
TAH111M-23	7314150308668	1	23,99	461
TAH111M-24	7314150308675	1	25,10	461
TAH111M-25	7314150399611	1	28,19	461
TAH111M-27	7314150308682	1	35,50	461
TAH111M-30	7314150308699	1	43,26	461
TAH111M-32	7314150308705	1	46,65	461
TAH111M-34	7314150308712	1	53,99	461
TAH111M-36	7314150308729	1	76,29	461
TAH111M-41	7314150308736	1	96,88	461
TAH111M-46	7314150308743	1	127,71	461
TAH111M-50	7314150308750	1	144,67	461
TAH111M-55	7314150411573	1	235,65	461
TAH111M-6	7314150308491	1	14,61	461
TAH111M-7	7314150308507	1	14,64	461



TAH111M-8	7314150308514	1	14,67	461
TAH111M-9	7314150308521	1	14,72	461
TAH111Z-1*	7314150343362	1	34,48	461
TAH111Z-1.1/16*	7314150343379	1	35,86	461
TAH111Z-1.1/2*	7314150431830	1	74,69	461
TAH111Z-1.1/4*	7314150343386	1	41,85	461
TAH111Z-1.1/8*	7314150343393	1	39,62	461
TAH111Z-1.11/16*	7314150431854	1	106,84	461
TAH111Z-1.13/16*	7314150431878	1	126,74	461
TAH111Z-1.3/4*	7314150431861	1	124,10	461
TAH111Z-1.3/8*	7314150431816	1	74,70	461
TAH111Z-1.5/16*	7314150343409	1	53,11	461
TAH111Z-1.5/8*	7314150431847	1	102,64	461
TAH111Z-1.7/16*	7314150431823	1	74,70	461
TAH111Z-1.7/8*	7314150431885	1	157,24	461
TAH111Z-1/2*	7314150343461	1	20,89	461
TAH111Z-11/16*	7314150343522	1	22,32	461
TAH111Z-13/16*	7314150343539	1	29,75	461
TAH111Z-15/16*	7314150343546	1	31,88	461
TAH111Z-2*	7314150431892	1	157,82	461
TAH111Z-2.1/4*	7314150431915	1	396,40	461
TAH111Z-2.3/4*	7314150431946	1	536,51	461
TAH111Z-2.3/8*	7314150413959	1	396,40	461
TAH111Z-2.5/8*	7314150431939	1	522,13	461
TAH111Z-2.7/8*	7314150431953	1	704,37	461
TAH111Z-3*	7314150431960	1	728,85	461
TAH111Z-3/8*	7314150343560	1	19,73	461
TAH111Z-5/16*	7314150343591	1	16,90	461
TAH111Z-5/8*	7314150343607	1	22,62	461
TAH111Z-7/8*	7314150343621	1	31,32	461
TAH111Z-9/16*	7314150343638	1	21,50	461
TAH1150-1/2H/P	7314150307760	1	135,31	476
TAH1177-SCRIBE	7314150307777	1	25,02	476
TAH140	7314150344475	1	74,20	463
TAH141	7314150339433	1	80,89	463
TAH1410	7314150344543	1	90,67	462
TAH142	7314150339440	1	105,96	463
TAH1420	7314150344550	1	100,30	462
TAH143	7314150344482	1	151,14	463
TAH1544	7314150307746	1	21,17	476
TAH16-H10	7314150306176	1	18,26	465
TAH16-H12	7314150306183	1	18,69	465
TAH16-H14	7314150306190	1	20,50	465
TAH16-H17	7314150306206	1	19,65	465
TAH16-H19	7314150306213	1	20,20	465
TAH16-H4	7314150306121	1	16,86	465
TAH16-H5	7314150306138	1	16,86	465
TAH16-H6	7314150306145	1	16,86	465
TAH16-H7	7314150306152	1	16,86	465
TAH16-H8	7314150306169	1	18,26	465
TAH16-T30	7314150306220	1	19,12	465
TAH16-T40	7314150306237	1	22,32	465
TAH16-T45*	7314150306244	1	22,32	465
TAH16-T50	7314150306251	1	22,32	465
TAH16-T55	7314150306268	1	27,94	465
TAH16-T60	7314150306275	1	27,94	465
TAH16B-1	7314150306077	1	14,33	465
TAH16B-1.1/16	7314150306084	1	17,25	465
TAH16B-1.1/4	7314150306107	1	17,26	465
TAH16B-1.1/8	7314150306114	1	17,25	465
TAH16B-1/2	7314150305995	1	9,60	465
TAH16B-10	7314150305629	1	8,46	464
TAH16B-11	7314150305636	1	8,46	464
TAH16B-11/16	7314150306022	1	11,11	465
TAH16B-12	7314150305643	1	8,96	464
TAH16B-13	7314150305650	1	9,35	464
TAH16B-13/16	7314150306046	1	12,27	465
TAH16B-14	7314150305667	1	9,82	464
TAH16B-15	7314150305674	1	10,20	464
TAH16B-15/16*	7314150306060	1	14,33	465
TAH16B-16	7314150305698	1	10,39	464
TAH16B-17	7314150305704	1	10,79	464
TAH16B-18	7314150305711	1	10,79	464
TAH16B-19	7314150305728	1	11,24	464
TAH16B-21	7314150305735	1	11,85	464
TAH16B-22	7314150305742	1	12,27	464
TAH16B-24	7314150305759	1	13,83	464
TAH16B-25	7314150305766	1	14,04	464
TAH16B-27	7314150305773	1	14,75	464
TAH16B-3/4	7314150306039	1	11,64	465
TAH16B-30	7314150305780	1	16,41	464
TAH16B-32	7314150305797	1	16,74	464
TAH16B-5/8	7314150306015	1	10,79	465
TAH16B-7/8*	7314150306053	1	12,69	465
TAH16B-8*	7314150305612	1	9,16	464
TAH16B-9/16	7314150306008	1	10,23	465
TAH16BM22	7314150422357	1	514,09	466
TAH16BZ17*	7314150422340	1	442,69	466
TAH16H-1/2	7314150306329	1	17,98	465

			€	
TAH16H-1/4	7314150306282	1	16,54	465
TAH16H-3/8	7314150306305	1	16,54	465
TAH16H-5/16	7314150306299	1	16,54	465
TAH16H-5/8	7314150306343	1	18,91	465
TAH16H-7/16	7314150306312	1	17,03	465
TAH16H-9/16	7314150306336	1	18,43	465
TAH1949M-10-11*	7314150308866	1	30,69	462
TAH1949M-12-14*	7314150308873	1	34,39	462
TAH1949M-14-17*	7314150308880	1	34,39	462
TAH1949M-19-22*	7314150308897	1	47,03	462
TAH1949M-24-27*	7314150308903	1	68,01	462
TAH1949M-8-9*	7314150308859	1	30,69	462
TAH1995M-10*	7314150432219	1	25,82	469
TAH1995M-12*	7314150432226	1	27,12	469
TAH1995M-8*	7314150432202	1	25,01	469
TAH1995Z-1/2*	7314150415007	1	28,81	469
TAH1RM-10	7314150414338	1	31,09	461
TAH1RM-11	7314150424306	1	32,80	461
TAH1RM-12	7314150424313	1	33,70	461
TAH1RM-13	7314150414345	1	32,83	461
TAH1RM-14	7314150424320	1	37,26	461
TAH1RM-15	7314150424337	1	38,29	461
TAH1RM-16	7314150414352	1	39,19	461
TAH1RM-17	7314150352210	1	39,19	461
TAH1RM-18	7314150414369	1	40,46	461
TAH1RM-19	7314150352227	1	42,27	461
TAH1RM-21	7314150424344	1	52,32	461
TAH1RM-22	7314150424351	1	50,63	461
TAH1RM-24	7314150352234	1	54,96	461
TAH1RM-27	7314150424368	1	83,30	461
TAH1RM-30	7314150352241	1	98,40	461
TAH1RM-32	7314150424375	1	109,18	461
TAH1RM-6	7314150424269	1	29,81	461
TAH1RM-7	7314150424276	1	29,81	461
TAH1RM-8	7314150424283	1	29,94	461
TAH1RM-9	7314150424290	1	30,98	461
TAH2047-0.8-4	7314150308088	1	28,81	469
TAH2047PR-1-2	7314150308095	1	32,42	469
TAH208*	7314150537112	1	39,14	472
TAH2101G-125	7314150344581	1	59,08	469
TAH2101G-125C*	7314150344598	1	59,08	469
TAH2101G-140	7314150307869	1	54,28	469
TAH2101G-140C*	7314150344611	1	62,11	469
TAH2101G-160	7314150307876	1	62,89	469
TAH2101G-160C*	7314150344635	1	62,89	469
TAH2101G-180	7314150345106	1	64,57	469
TAH2101G-180C*	7314150344666	1	64,57	469
TAH21HDG-200	7314150345649	1	65,94	470
TAH21HDG-200C	7314150345656	1	65,94	470
TAH2223G-150	7314150411597	1	58,28	470
TAH225-PLUS	7314150319978	1	55,37	472
TAH2339-250	7314150536320	1	40,85	471
TAH2427G-200	7314150307883	1	46,11	470
TAH2430G-160	7314150413942	1	44,39	470
TAH2430G-200	7314150307906	1	44,92	470
TAH2484-30	7314150307968	1	15,88	475
TAH2487	7314150320028	1	22,09	477
TAH24B-27	7314150309306	1	25,95	466
TAH24B-30	7314150309313	1	29,12	466
TAH24B-32	7314150309320	1	30,32	466
TAH24B-36	7314150309337	1	35,05	466
TAH24B-38	7314150309344	1	37,33	466
TAH24B-41	7314150309351	1	41,13	466
TAH24B-46	7314150309368	1	48,53	466
TAH24B-50	7314150309375	1	54,84	466
TAH2509	7314150307753	1	96,93	477
TAH2535F2	7314150307784	1	52,72	477
TAH2628G-160	7314150307913	1	58,45	470
TAH2628G-180	7314150307920	1	60,24	470
TAH2628G-200*	7314150432363	1	76,89	470
TAH2633/S4	7314150415014	1	126,32	477
TAH2800-150	7314150519330	1	46,15	470
TAH2800-180	7314150424559	1	77,81	470
TAH2820EF2	7314150307708	1	28,39	473
TAH2855	7314150307937	1	211,20	471
TAH2900-180	7314150424566	1	78,46	470
TAH2951-250	7314150432400	1	63,91	471
TAH2953-140	7314150415731	1	59,12	471
TAH2953-300	7314150415748	1	75,21	471
TAH2958-200	7314150320219	1	47,32	471
TAH2958-250	7314150307944	1	51,13	471
TAH2970G-200*	7314150343331	1	61,25	470
TAH29M-10	7314150414413	1	82,00	462
TAH29M-11*	7314150414420	1	82,65	462
TAH29M-12*	7314150424382	1	82,65	462
TAH29M-13	7314150414437	1	82,65	462
TAH29M-14*	7314150424399	1	82,65	462
TAH29M-15*	7314150424405	1	82,65	462
TAH29M-16*	7314150424412	1	82,65	462

\* Hasta agotar existencias

			€	
TAH29M-17*	7314150414444	1	83,28	462
TAH29M-18*	7314150424429	1	83,28	462
TAH29M-19*	7314150424436	1	83,28	462
TAH29M-20*	7314150424443	1	83,28	462
TAH29M-21*	7314150414451	1	86,93	462
TAH29M-22*	7314150424450	1	86,93	462
TAH29M-23*	7314150424467	1	87,58	462
TAH29M-24*	7314150424474	1	92,30	462
TAH29M-25*	7314150424481	1	92,98	462
TAH29M-26*	7314150424498	1	98,03	462
TAH29M-27*	7314150424504	1	96,91	462
TAH29M-28*	7314150424511	1	100,56	462
TAH29M-29*	7314150424528	1	105,24	462
TAH29M-30*	7314150424535	1	108,01	462
TAH29M-32*	7314150424542	1	113,19	462
TAH29M-6*	7314150414376	1	79,43	462
TAH29M-7	7314150414383	1	80,72	462
TAH29M-8	7314150414390	1	82,00	462
TAH29M-9*	7314150414406	1	82,00	462
TAH2M-10-11*	7314150427772	1	54,66	461
TAH2M-12-13*	7314150427789	1	55,28	461
TAH2M-14-15*	7314150427796	1	56,70	461
TAH2M-16-17*	7314150427802	1	58,06	461
TAH2M-18-19*	7314150427819	1	59,97	461
TAH2M-6-7*	7314150427758	1	51,64	461
TAH2M-8-9*	7314150427765	1	53,74	461
TAH302-35*	7314150482924	1	38,11	463
TAH317	7314150319985	1	40,46	472
TAH317-40*	7314150482887	1	28,22	463
TAH320	7314150319992	1	29,66	471
TAH325	7314150320004	1	75,26	471
TAH3625PU-50	7314150307579	1	64,41	473
TAH3625S-28*	7314150500727	1	35,47	473
TAH3625W-35	7314150307609	1	54,48	473
TAH3640-250-C	7314150307975	1	34,91	473
TAH3681-11	7314150415038	1	73,63	475
TAH3681-16	7314150415045	1	81,40	475
TAH3681-20*	7314150415052	1	100,06	475
TAH3683	7314150352258	1	44,73	475
TAH3734BM-10	7314150308057	1	24,07	474
TAH3734BM-2	7314150343348	1	30,85	474
TAH3734BM-3	7314150307982	1	30,85	474
TAH3734BM-4	7314150308019	1	31,32	474
TAH3734BM-5	7314150308026	1	31,32	474
TAH3734BM-6	7314150308033	1	32,20	474
TAH3734BM-8	7314150308040	1	32,42	474
TAH3739-300*	7314150373925	1	35,17	475
TAH3755BM-4	7314150308064	1	17,04	475
TAH380-10	7314150307845	1	73,27	463
TAH380-14	7314150320172	1	97,41	463
TAH380-18	7314150307852	1	139,11	463
TAH380-24	7314150343317	1	206,37	463
TAH396-JT	7314150373932	1	60,12	471
TAH401-16*	7314150482948	1	36,72	463
TAH401-28*	7314150482962	1	38,69	463
TAH402-35*	7314150482900	1	60,53	463
TAH4205H-80-160*	7314150411610	1	46,16	477
TAH466-250	7314150307791	1	45,75	475
TAH479-16	7314150307586	1	64,82	473
TAH479-32	7314150307593	1	70,96	473
TAH481-300	7314150307616	1	51,36	474
TAH484-1000	7314150373918	1	64,11	474
TAH484-1500	7314150307623	1	62,07	474
TAH484-2000	7314150319916	1	65,10	474
TAH485	7314150459902	1	62,49	474
TAH486F-700	7314150370658	1	32,85	474
TAH487-5200	7314150307630	1	612,43	474
TAH489-1100	7314150307647	1	211,09	474
TAH489-1800	7314150343294	1	226,10	474
TAH489-2700	7314150319923	1	235,45	474
TAH489-3600	7314150307654	1	259,68	474
TAH489-4500	7314150427567	1	362,70	474
TAH489-5400	7314150319930	1	306,49	474
TAH490-1100*	7314150427475	1	167,08	474
TAH52	7314150339730	1	25,42	473
TAH529S-20-XL*	7314150482825	1	54,93	473
TAH6950	7314150309054	1	52,74	464
TAH6956-1	7314150309061	1	15,60	464
TAH6958B-1	7314150309078	1	45,63	463
TAH6960	7314150305315	1	12,26	464
TAH6961	7314150305322	1	13,30	464
TAH6962	7314150305339	1	17,00	464
TAH6962L	7314150305346	1	38,77	464
TAH6966	7314150305353	1	30,69	464
TAH6M-10-11	7314150370665	1	17,24	462
TAH6M-12-13	7314150370672	1	17,67	462
TAH6M-14-15	7314150400393	1	17,93	462
TAH6M-16-17	7314150400409	1	18,29	462
TAH6M-17-19	7314150370689	1	21,06	462



# TAH6M-18-19



TAH6M-18-19	7314150400416	1	21,17	462
TAH6M-20-22	7314150400423	1	25,83	462
TAH6M-24-27	7314150400430	1	45,23	462
TAH6M-30-32	7314150400447	1	52,43	462
TAH6M-6-7	7314150427741	1	14,16	462
TAH6M-8-9	7314150400386	1	14,78	462
TAH700-1.5-50	7314150432301	1	56,07	468
TAH700-1.8-50	7314150432318	1	56,07	468
TAH700-2.5-50	7314150432325	1	56,57	468
TAH700-3-100	7314150432332	1	56,57	468
TAH701-0-50	7314150432349	1	56,12	468
TAH701-00-50	7314150432356	1	56,12	468
TAH703-10-50	7314150432288	1	56,24	468
TAH703-15-75	7314150432295	1	56,45	468
TAH703-6-50	7314150432240	1	56,27	468
TAH703-7-50	7314150432257	1	56,27	468
TAH703-8-50	7314150432264	1	56,27	468
TAH703-9-50	7314150432271	1	56,32	468
TAH73R-100	7314150503810	1	455,63	476
TAH73R-200	7314150503834	1	470,82	476
TAH73R-300	7314150503858	1	488,18	476
TAH7444SG-M-36	7314150308934	1	68,62	462
TAH7444SG-M-41	7314150308941	1	87,59	462
TAH7444SG-M-46	7314150308958	1	96,03	462
TAH7444SG-M-50	7314150308965	1	107,95	462
TAH7444SG-M-55	7314150308972	1	123,45	462
TAH7452-2*	7314150302543	1	124,27	477
TAH7465-15*	7314150482849	1	242,00	476
TAH74R-1500	7314150543144	1	2.885,00	477
TAH74W9-100	7314150519354	1	268,33	476
TAH7809M-10-140*	7314150501175	1	30,50	465
TAH7809M-8-120*	7314150501199	1	29,60	465
TAH7809XZN-10	7314150552351	1	32,02	466
TAH7809XZN-12	7314150552375	1	33,94	466
TAH7809XZN-14	7314150552399	1	33,94	466
TAH7809XZN-16	7314150552412	1	35,24	466
TAH7809XZN-18	7314150552436	1	35,38	466
TAH7809XZN-6	7314150552313	1	32,36	466
TAH7809XZN-8	7314150552337	1	32,02	466
TAH782-U	7314150339747	1	24,32	473
TAH7852-1*	7314150302550	1	99,20	477
TAH8069	7314150383603	1	54,23	461
TAH8069C*	7314150383610	1	56,64	461
TAH8070	7314150347025	1	52,21	461
TAH8070C*	7314150383627	1	40,55	461
TAH8071	7314150347032	1	56,33	461
TAH8071C*	7314150383634	1	41,99	461
TAH8072	7314150307487	1	52,31	461
TAH8072C*	7314150383641	1	46,04	461
TAH8073	7314150319831	1	75,99	461
TAH8073C*	7314150383658	1	55,96	461
TAH8074	7314150319848	1	124,22	461
TAH8074C*	7314150383665	1	93,52	461
TAH8075	7314150307500	1	195,16	461
TAH8075C*	7314150383672	1	133,78	461
TAH8150-1/2	7314150309283	1	84,27	466
TAH8158B-1	7314150309290	1	110,09	465
TAH8160	7314150306367	1	84,31	465
TAH8162	7314150306374	1	103,56	465
TAH8166	7314150306381	1	42,81	465
TAH8224	7314150307951	1	75,73	471
TAH84-PODGER	7314150312221	1	54,03	461
TAH8950N/A*	7314150309382	1	209,92	466
TAH8953*	7314150309399	1	57,76	466
TAH8961	7314150309405	1	50,69	466
TAH900T-020-100	7314150552153	1	37,00	468
TAH900T-025-100	7314150552177	1	37,00	468
TAH900T-030-100	7314150552191	1	37,00	468
TAH900T-040-150	7314150552214	1	37,50	468
TAH900T-050-150	7314150552238	1	37,50	468
TAH900T-060-200	7314150552252	1	38,50	468
TAH900T-080-200	7314150552276	1	39,50	468
TAH900T-100-200	7314150552290	1	41,50	468
TAH901T-006-100	7314150551880	1	32,00	469
TAH901T-007-100	7314150551903	1	32,00	469
TAH901T-008-100	7314150551927	1	32,00	469
TAH901T-009-100	7314150551941	1	32,00	469
TAH901T-010-100	7314150551965	1	32,00	469
TAH901T-015-150	7314150551989	1	33,00	469
TAH901T-020-150	7314150552009	1	33,00	469
TAH901T-025-150	7314150552023	1	33,00	469
TAH901T-027-150	7314150552047	1	33,00	469
TAH901T-030-200	7314150552061	1	34,00	469
TAH901T-040-200	7314150552085	1	35,00	469
TAH901T-045-200	7314150552108	1	35,60	469
TAH901T-050-200	7314150552139	1	37,50	469
TAH9045-B-250	7314150411634	1	38,18	476
TAH9048-250*	7314150411627	1	39,38	476
TAH9070	7314150307517	1	45,93	460



TAH9072	7314150307524	1	64,93	460
TAHBE-8020L	7314150308101	1	19,84	467
TAHBE-8030	7314150308118	1	20,38	467
TAHBE-8040	7314150308125	1	21,30	467
TAHBE-8040S	7314150308132	1	13,55	468
TAHBE-8050S	7314150308149	1	16,17	468
TAHBE-8155	7314150308156	1	30,86	467
TAHBE-8220S	7314150308163	1	11,18	468
TAHBE-8241	7314150308217	1	24,92	467
TAHBE-8252	7314150308224	1	29,19	467
TAHBE-8255S	7314150320226	1	20,68	468
TAHBE-8257	7314150308231	1	36,19	467
TAHBE-8258	7314150308248	1	38,63	467
TAHBE-8260	7314150308255	1	42,00	467
TAHBE-8350	7314150308262	1	22,36	467
TAHBE-8602	7314150308279	1	24,74	467
TAHBE-8610	7314150308286	1	24,42	467
TAHBE-8610S	7314150308293	1	14,38	468
TAHBE-8611	7314150308309	1	24,56	467
TAHBE-8620	7314150308316	1	28,39	467
TAHBE-8620L	7314150308323	1	31,97	467
TAHBE-8620S	7314150308330	1	18,56	468
TAHBE-8623	7314150308347	1	36,05	467
TAHBE-8624	7314150308354	1	41,19	467
TAHBE-8630	7314150308361	1	43,90	467
TAHBE-8630S	7314150320233	1	23,78	468
TAHBE-8640S	7314150320240	1	35,21	468
TAHBE-8810	7314150308378	1	26,05	467
TAHBE-8820	7314150308385	1	29,87	467
TAHBE-8820SL	7314150347827	1	22,34	468
TAHBE-8830	7314150308392	1	43,90	467
TAHBE-8880	7314150432196	1	55,20	467
TAHBE-8910	7314150343713	1	27,92	468
TAHBE-8910S	7314150343799	1	20,61	468
TAHBE-8915	7314150343744	1	28,85	468
TAHBE-8915S	7314150343805	1	26,10	468
TAHBE-8920	7314150343751	1	30,22	468
TAHBE-8920S	7314150343812	1	30,92	468
TAHBE-8925	7314150343768	1	31,60	468
TAHBE-8925S	7314150343829	1	32,98	468
TAHBE-8930	7314150343775	1	32,98	468
TAHBE-8930S	7314150343836	1	34,35	468
TAHBE-9776	7314150432233	1	49,88	469
TAHBE-9777B	7314150307685	1	40,95	469
TAHBE-9787	7314150307692	1	43,85	469
TAHBE64520	7314150307821	1	99,22	477
TAHBFRL11	7314150307739	1	79,94	478
TAHBOD5400	7314150339457	1	52,95	478
TAHBOD5450	7314150339464	1	73,07	478
TAHCRW01	7314150432370	1	155,56	470
TAHCS300*	7314150411603	1	38,18	476
TAHLTS-30*	7314150432387	1	84,05	475
TAHMA421*	7314150482863	1	23,22	472
TAHMK5	7314150411580	1	45,73	462
TAHMTT151	7314150504190	1	50,00	473
TAHNS502-1000-FB	7314150482801	1	204,50	474
TAHPINRELEASER	7314150307838	1	49,42	466
TAHSC2RM-13-17	7314150339792	1	56,33	462
TAHSC2RM-15-17	7314150339785	1	68,69	462
TAHSC2RM-19-22	7314150339761	1	75,57	462
TAHSC2RM-27-30	7314150339778	1	123,65	462
TAHSCB140G	7314150308071	1	42,93	473
TAHSR300-MM	7314150415021	1	52,71	475
TAHWBB400	7314150500703	1	32,70	474
TAHWBB600	7314150440429	1	40,31	474
TAHWBB700	7314150440436	1	42,93	474
TAM12135	7314150215331	1	416,17	121
TAM12200	7314150215348	1	416,17	121
TAM12340	7314150215355	1	509,47	121
TAM1430	7314150215317	1	373,20	121
TAM38135	7314150215324	1	373,20	121
TAS14H007	7314150423187	1	729,09	117
TAS14H09	7314150423200	1	748,61	117
TAS14S007	7314150423194	1	729,09	117
TAS14S09	7314150423217	1	748,61	117
TASM14H007	7314150539444	1	1.124,55	117
TASM14H09	7314150539437	1	1.156,38	117
TASMB14H007	7314150489664	1	1.655,19	117
TASMB14H09	7314150489671	1	1.693,69	117
TAW12340	7314150274963	1	797,65	111
TAW1412M	7314150423156	1	943,63	111
TAW1430M	7314150422289	1	943,63	111
TAW14340	7314150340842	1	1.071,13	111
TAW24800	7314150368297	1	1.270,30	111
TAW34800	7314150285471	1	1.416,52	111
TAW38135	7314150274956	1	728,89	111
TAW38135M	7314150502295	1	936,66	111
TAW912M	7314150423163	1	834,01	111
TAW9135	7314150340859	1	967,89	111



TAW9135M	7314150502288	1	910,99	111
TAW930M	7314150422319	1	855,57	111
TAWM12340	7314150274925	1	1.237,73	110
TAWM1412M	7314150423149	1	1.083,78	110
TAWM1430*	7314150274901	1	754,15	110
TAWM1430M	7314150422265	1	1.096,92	110
TAWM14340	7314150340835	1	1.303,42	110
TAWM24800	7314150368280	1	1.922,88	110
TAWM34800	7314150274932	1	1.780,94	110
TAWM38135	7314150274918	1	1.258,74	110
TAWM38135M	7314150502264	1	1.302,34	110
TAWM912M	7314150423132	1	1.058,20	110
TAWM9135	7314150340828	1	1.213,09	110
TAWM9135M	7314150502271	1	1.276,69	110
TAWM930A*	7314150275724	1	230,55	111
TAWM930M	7314150422241	1	1.117,39	110
TAWMB14340	7314150489626	1	1.988,81	110
TAWMB24650	7314150490103	1	2.296,75	110
TAWMB24800	7314150489633	1	2.552,60	110
TAWMB9135M	7314150490110	1	1.873,32	110
TAWMB930M	7314150489640	1	1.757,85	110
TEA003	7314150422180	1	1.615,51	120
TEA010	7314150422197	1	1.615,51	120
TEA030A	7314150522750	1	1.538,31	120
TEA065	7314150472246	1	1.521,27	121
TEA1100	7314150423170	1	2.019,38	121
TEA2100	7314150465972	1	2.517,50	121
TEA350	7314150422210	1	1.503,52	121
TJS003	7314150522477	1	298,11	120
TJS010	7314150522484	1	304,48	120
TJS030	7314150522491	1	322,51	120
TL 00-SA	7314150109579	1	39,41	638
TL 00-SA-ET	7311518279219	1	46,46	642
TL 00-SA-SL	7314150115228	5	19,68	643
TL 000-SA	7314150522934	1	31,92	639
TL 00ACF	7314150522958	1	8,14	646
TL 00B-SA	7314150109555	1	43,74	638
TL 00CFR-SA	7314150115402	1	51,69	641
TL 00D-SA	7314150109562	1	43,74	638
TL 009-SA	7314150109586	1	37,80	639
TL 1-SA	7314150109647	1	37,80	639
TL 1-SA-SL	7314150115235	5	18,91	643
TL 124-SA	7314150110018	1	32,52	646
TL 15A	7314150522972	1	55,15	638
TL 15AGW	7314150522996	1	55,06	638
TL 15AGWHM-SA	7314150523016	1	93,19	638
TL 2-SA-SL	7314150115242	5	19,32	643
TL 242ACF	7314150523030	1	8,14	647
TL 242CFR-SA	7314150523054	1	27,66	640
TL 249 ACF	7314150115174	1	15,61	647
TL 249CFR-SA	7314150115143	1	51,69	640
TL 259 ACF	7314150115167	1	15,61	647
TL 259 CFR-SA	7314150115150	1	51,69	640
TL 259ACP	7314150465590	1	109,99	647
TL 259ASV	7314150465569	1	13,42	647
TL 259CPR-SA	7314150523078	1	28,95	641
TL 259SVR-SA	7314150523092	1	43,45	641
TL 2A ACF	7314150115457	1	15,61	647
TL 2A-SA	7314150110100	1	38,63	639
TL 2A-SA-ET	7314150523115	1	35,29	642
TL 2A-SA-SL	7314150115259	5	19,32	643
TL 2ACFR-SA	7314150115419	1	51,69	641
TL 3-SA	7314150110162	1	37,80	639
TL 3-SA-ET	7311518279356	1	46,46	642
TL 3-SA-SL	7314150115266	5	18,91	643
TL 34A-SA	7314150524068	1	41,75	640
TL 3C-SA	7314150110148	1	37,80	639
TL 3C-SA-ET	7314150523139	1	35,67	642
TL 3C-SA-SL	7314150115273	5	18,91	643
TL 4-SA-SL	7314150115280	5	21,01	643
TL 475-SA	7314150110032	1	38,53	646
TL 5-SA	7314150110247	1	45,82	639
TL 5-SA-ET	7314150523153	1	39,28	642
TL 5-SA-SL	7314150115297	5	22,93	644
TL 51S-SA	7314150110209	1	42,45	639
TL 578-SA	7314150110438	1	33,83	646
TL 582-SA	7314150110452	1	33,83	646
TL 5A-SA-SL	7314150115303	5	22,93	644
TL 5ACF	7314150115464	1	15,61	647
TL 5ACP	7314150465606	1	109,99	648
TL 5ASV	7314150465576	1	109,99	647
TL 5B-SA	7314150110223	1	49,20	640
TL 5CF-SA	7314150523177	1	26,49	641
TL 5CFR-SA	7314150115426	1	51,69	641
TL 5CPR-SA	7314150523191	1	28,95	641
TL 5SVR-SA	7314150523214	1	28,95	641
TL 6-SA	7314150523238	1	41,75	640
TL 648-SA	7314150110049	1	34,54	646
TL 649-SA	7314150110063	1	34,44	646

TL 65A-SA	7314150110278	1	44,14	640
TL 7-SA	7314150110292	1	49,20	640
TL 7-SA-ET	7314150523252	1	41,23	643
TL 7-SA-SL	7314150115310	5	24,59	644
TL 7A-SA	7314150110285	1	49,20	640
TL 7A-SA-ET	7314150523283	1	41,23	643
TL 7A-SA-SL	7314150115327	5	24,79	644
TL 7ACF	7314150115471	1	15,61	647
TL 7ACP	7314150465613	1	109,99	648
TL 7ASV	7314150465583	1	109,99	648
TL 7CFR-SA	7314150115433	1	51,69	642
TL 7CPR-SA	7314150523306	1	28,95	641
TL 7SVR-SA	7314150523320	1	28,95	642
TL AA-SA-ET	7314150523344	1	28,83	642
TL AA-SA-SL	7314150115334	5	11,55	644
TL AC-SA-SL	7314150115341	5	18,95	644
TL MM-SA-SL	7314150115365	5	11,55	644
TL SM 103-SA	7314150110773	1	41,46	645
TL SM 104-SA	7314150110780	1	41,46	644
TL SM 105-SA	7314150110797	1	41,46	645
TL SM 107-SA	7314150110810	1	41,46	645
TL SM 108-SA	7314150110827	1	41,46	645
TL SM 109-SA	7314150110834	1	41,46	645
TL SM 110-SA	7314150110841	1	41,46	645
TL SM 111-SA	7314150110858	1	41,46	645
TL SM 115-SA	7314150110896	1	41,46	646
TL SM 117-SA	7314150110919	1	41,46	646
TL SM106-SA	7314150523368	1	24,42	645
TL SM116-SA	7314150523382	1	24,42	645
TL SM116-SA-ET	7314150523405	1	41,75	642
TL SS-SA	7314150109937	1	37,80	639
TL SS-SA-SL	7314150115358	5	18,91	644
TR0325M03X-50	7314150501632	5	23,23	153
TR0636M06X-65	7314150501663	5	43,22	153
TR0650M06X-80	7314150501694	5	48,55	153
TR0860M08X-110	7314150507269	5	63,92	153
TR4.530M06X-90	7314150501755	5	41,50	153
TRX 8180	7314150112272	5	61,80	629
TSS120	7314150347063	1	225,69	118
TSS600	7314150346417	1	225,69	118
W-S-1.0	7311518140816	4	20,73	587
W-S-2.0	7311518140823	4	26,42	587
W-S-2.5	7311518140830	4	32,78	587
W-T-2.0	7311518140847	4	59,68	587
WBB1000	7314150431502	4	42,80	598
WBB1200	7314150431519	4	49,52	598
WBB1500	7314150431526	4	66,00	598
WBB400	7314150315215	10	19,99	598
WBB500	7314150315222	10	21,33	598
WBB600	7314150315239	10	22,66	598
WBB700	7314150315246	6	24,66	598
WBB800	7314150340972	6	28,00	598
WBF380	7314150315253	12	21,33	598
WBMF190	7314150315260	24	10,60	598
WBMF190IP	7314150457960	15	10,94	598
WBP-3P-6FMF	7314150453115	1	79,31	599
WBP-3P-96F	7314150453108	1	152,53	599
WBP300	7314150315161	20	38,66	598
WBP500	7314150315178	12	42,65	598
WBP625	7314150315185	12	55,99	598
WBP710	7314150315192	10	62,64	598
WBP900	7314150315208	6	91,98	598
WC-HOL	7314150333158	1	4,25	561
WPH 2-50	7314150520428	1	141,10	595
WPH 3-20	8412814125435	1	34,29	595
WPH 3-30	8412814125442	1	46,05	595
WR1	7314150167425	50	4,80	531
WR1-MM	7314150220069	50	4,81	531
WR2	7314150167432	25	6,40	531
WR2-12	7314150185627	25	6,40	531
WR2-MM	7314150220038	25	7,70	531
XLARGE	7314150437412	1	7.069,07	369
XXL	7314150504152	1	8.195,45	368

\* Hasta agotar existencias





## Bimetal y Metal duro

		Anchura de la sierra de cinta							
		≤ 20 mm €	27 mm €	34 mm €	41 mm €	54 mm €	67 mm €	80 mm €	100 mm €
BIMETAL	3851 SANDFLEX® Cobra	6,70	7,47	8,55	8,55	17,82	21,12	21,12	*
	3851 SANDFLEX® Cobra PSG	*	7,47	8,55	8,55	17,82	*	*	*
	3853 SANDFLEX® Top Fabricator™	6,70	7,47	8,55	8,55	17,82	21,12	*	*
	3854 SANDFLEX® King Cobra PHG	*	7,47	8,55	8,55	17,82	21,12	21,12	*
	3857 SANDFLEX® Easy-Cut	6,70	7,47	8,55	*	*	*	*	*
	3858 PHX	*	*	8,55	8,55	17,82	21,12	21,12	*
METAL DURO	3860 Unset carbide	*	7,47	8,55	8,55	17,82	21,12	21,12	21,12
	3868 Carbide Triple Set® "Xtra"™	*	7,47	8,55	8,55	17,82	21,12	21,12	*
	3869 Carbide Triple Set®	6,70	7,47	8,55	*	*	*	*	*
	3881 Carbide Triple High Quad	*	*	8,55	8,55	17,82	21,12	21,12	21,12

# Condiciones de Venta

1. Las presentes Condiciones Generales estarán en vigor desde 02-2025 y vienen a sustituir y dejar sin efecto a todas las Condiciones Generales anteriormente aplicadas.

2. Nuestros productos se identifican, exclusivamente, por sus referencias. Por ello, los pedidos deben mencionar, claramente en cada caso, la referencia y el número de unidades de la misma que se desea adquirir. Una vez aceptado el pedido, la obligación de SNA Europe Industries Iberia, S.A. queda limitada al suministro de dichas unidades de la referencia solicitada. Las dimensiones y características técnicas de los productos que se incluyen en nuestro catálogo comercial, son meramente ilustrativas y están sujetas a modificaciones, por lo que SNA Europe Industries Iberia, S.A. recomienda a sus clientes que, antes de formular un pedido, comprueben que la referencia solicitada se ajusta, en cuanto a dimensiones y demás características a sus necesidades.

3. SNA Europe establece un importe mínimo por pedido de 100 € para la aceptación de los mismos.

4. Los pedidos inferiores a 450 € en Península y 680 € para Canarias, Ceuta y Melilla, se enviarán a portes pagados, cargando en factura el coste de este servicio.

5. Los precios para envíos a las provincias españolas fuera de la península se entienden para mercancía puesta en el puerto de destino (C & F).

6. La elección del medio de transporte será por cuenta de SNA Europe Industries Iberia, S.A.

7. Los clientes tienen la obligación de examinar los productos servidos a su recepción, a fin de comprobar su conformidad con el pedido en cuanto a la referencia o referencias servidas y el número de unidades entregadas. Si existiera alguna disconformidad, el cliente deberá ponerlo de manifiesto, bien rechazando la mercancía si su disconformidad es total, bien recibéndola parcialmente y haciendo constar en el albarán de entrega su queja en cuanto al producto rechazado en el caso de disconformidad parcial. La firma del albarán de entregas, sin salvedad alguna, supondrá la aceptación de la mercancía y la conformidad del cliente en cuanto a la cantidad y referencia(s) servida(s), todo ello sin perjuicio de la garantía de producto aquí prevista.

8. La transmisión de la propiedad de la mercancía en favor del cliente no tendrá lugar hasta el momento de la efectividad del completo pago de su precio, con independencia de que la misma haya sido entregada y puesta a disposición del cliente. En este caso, y hasta la efectiva transmisión de la propiedad mediante el pago, el cliente se abstendrá de realizar cualquier acto de disposición sobre la mercancía o de almacenarla y/o utilizarla de forma tal que pueda sufrir algún menoscabo, siendo responsable frente a SNA Europe Industries Iberia, S.A. del estado de la misma en este tiempo. En el supuesto de que, llegado el vencimiento del pago, este no se haga efectivo por el cliente, SNA Europe Industries Iberia, S.A. tendrá la facultad alternativa de exigir el pago del precio, con sus intereses o la devolución de la mercancía, sin perjuicio en cualquiera de ambos casos de las indemnizaciones de daños y perjuicios a la que por ley tenga derecho.

9. La mercancía será servida en función de las circunstancias del pedido (Número de unidades y clase de la referencia solicitada) y de la disponibilidad de producto de SNA Europe Industries Iberia, S.A. en el momento. Si el cliente precisa que la entrega se realice en un plazo determinado deberá ponerlo de manifiesto en su escrito de pedido, no habiendo lugar a ninguna reclamación por retraso en la entrega, salvo que expresamente se pacte otra cosa.

10. Forma de pago: A 60 días fecha factura. Los clientes que tengan día de vencimiento fijo, se les girará al más próximo a los 60 días fecha factura, de forma que todos los giros quedarán comprendidos entre los 45 y 75 días f.f.

11. Los pedidos, una vez aceptados por SNA Europe Industries Iberia, S.A., serán irrevocables y no podrán ser anulados o modificados de ninguna manera por el cliente, salvo que medie expreso acuerdo en dicho sentido con SNA Europe Industries Iberia, S.A. Si un pedido, por la especial naturaleza de su objeto u otras circunstancias, requiere alguna clase de cambio en los procesos de fabricación y/o envasado normalmente seguidos por SNA Europe Industries Iberia, S.A., se considerará como definitivo e irrevocable en todos sus conceptos desde el mismo momento de su emisión por el cliente, viniendo éste obligado a la recepción de la mercancía en todo caso. De no hacerlo así y rehusar la mercancía SNA Europe Industries Iberia, S.A. podrá exigirle el precio del pedido, más un 50% del mismo, en concepto de penalización.

## REPOSICIÓN DE GARANTÍA

1. Todos los productos del catálogo están amparados por la Garantía Total contra cualquier defecto de fabricación o material, de forma que los clientes tendrán derecho a la reposición de la pieza o piezas defectuosas siempre que el defecto tenga su origen directo en la fabricación o de material de la misma.

2. El derecho de reposición se limita a la sustitución de la pieza defectuosa por otra nueva y no comprenderá abono de ninguna clase, siendo todos los gastos de la reposición, en particular el transporte, de cargo del cliente.

3. La Garantía Total no ampara los defectos provenientes del desgaste o de la mala conservación y/o utilización de los productos por el cliente.

4. El plazo de garantía es de un año a partir de la fecha de compra en el caso de los productos sujetos a desgaste normal con el uso tales como cuchillas, puntas, brocas, y otros productos consumibles. En el caso de multiplicadores de par, la garantía no se aplicará en los casos en los que el producto haya sido sometido a esfuerzos superiores a sus valores nominales máximos.

5. Para el correcto ejercicio de este derecho el cliente deberá comunicar por escrito a SNA EUROPE INDUSTRIES IBERIA, S.A. el defecto y las piezas afectadas, indicando los datos relativos a la compra (fecha y número de factura). En el plazo de 30 días a contar desde la recepción de dicha comunicación, SNA EUROPE INDUSTRIES IBERIA, S.A. enviará a su representante de plaza a las instalaciones del cliente, a fin de suscribir conjuntamente la documentación relativa a las piezas defectuosas. Inmediatamente después las mismas o una muestra escogida por el representante de plaza, serán remitidas a SNA EUROPE INDUSTRIES IBERIA, S.A. a fin de que su Departamento de Calidad certifique el defecto. En el supuesto de que el informe del Departamento de Calidad confirme el defecto, SNA EUROPE INDUSTRIES IBERIA, S.A. lo comunicará al cliente, anunciando la reposición de las piezas defectuosas.

6. La reposición se llevará a cabo en el menor plazo de tiempo posible y como norma se producirá junto con el más próximo envío de mercancía al cliente.

7. A la recepción de las piezas repuestas, el cliente deberá suscribir un documento manifestando su conformidad con la reposición efectuada y se renuncia a cualquier reclamación ulterior a SNA EUROPE INDUSTRIES IBERIA, S.A. por dicho motivo.









# Contacto

## Argentina

**SNAE Argentina SRL**  
A.M. de Justo 1750 3° A  
C1107AFJ - Capital Federal  
Buenos Aires  
Tel: +54 (11) 4313-1004  
Fax: +54 (11) 4893-3553

## Australia

**SNAE Australia**  
3 Cooper Street, Smithfield,  
NSW 2164  
Tel: +61 (0) 2 8787 5700  
Fax: +61 (0) 2 9756 6130

## Belgium

**Branch of SNA Europe (Benelux) BV**  
De Kleetlaan 12A Pegasus Park  
1831 DIEGEM  
Tel: +32 (0)2 726 03 03  
info.be@bahco.com

## Chile

**Comercial SNAE Chile LTDA**  
Av. Americo Vespuccio 2760-D  
Conchalí - Santiago - Chile  
Tel: + 56 2 623 0203  
Fax: + 56 2 623 5395

## Česká republika

**SNA Europe s.r.o.**  
Holadnská 2/4  
639 00 Brno  
Tel: +420 537 022 520  
Fax: +420 537 022 200

## Danmark

**SNA Europe [Denmark] A/S**  
Vallensbækvej 40,  
2605 Brøndby  
Tel: +45 4363 0330  
Fax: +45 4396 2456

## Deutschland

**SNA Europe [Germany]**  
Willettstraße 10  
40822 Mettmann  
Tel: +49 (0) 2104 833 83 0  
Fax: +49 (0) 2104 833 83 7999

## España

**SNA Europe [Industries] Iberia SA**  
c/ Hilanderas, 1  
(P.O. Box / Apdo de Correos nº 5)  
C.P. 20303 Irún  
Tel: +34 902 235 100 / +34 943 649 111  
Fax: +34 943 649 120

## Ελλάδα

**SNA Europe**  
Λ. Βουλιαγμένης 604Γ  
167 77 Ελληνικό, Αθήνα  
Τηλ: +30 210 9914263  
Info.gr@snaeurope.com

## Export

**SNA Europe**  
Antigua Carretera de Altube Km 5,5  
P.O.Box 307  
01080 VITORIA (Spain)  
Tel: +34 945269711  
Fax: +34 945165040

## France

**SNA EUROPE (France)**  
41 Boulevard Pierre de Coubertin  
49 000 ANGERS  
Tél: +33 (0) 2 41 22 98 40  
Fax: +33 (0) 2 41 22 98 50

## Italia

**SNA EUROPE Italia S.p.A.**  
Via Georges Bizet, 13/15  
20092 Cinisello Balsamo MI - Italia  
Tel. +39 02 3024161  
info.it@snaeurope.com

## Қазақстан

050000, Алматы,  
ул.Шевченко 1656/72г, оф.217  
Тел/факс +7 727323 63 39

## Nederland

**SNA Europe [Benelux] BV**  
Vossenbeemd 113  
5705 CL Helmond  
Tel: +31 (0) 492 58 23 82  
info.nl@bahco.com

## New Zealand

**SNAE New Zealand**  
Unit 3/25 Highbrook Drive  
East Tamaki  
Auckland  
Tel: +64 9-273 46 50  
Fax: +64-9-273-2453

## Norge

**SNA Europe [Norway]**  
Box 800  
1306 Sandvika  
Tel: +47 40 49 66 00  
Fax: +47 67 17 56 51

## Österreich

**SNA Europe**  
Vienna, Nineteen, Mooslackengasse 17  
A - 1190 Wien  
Tel: +49 (0) 2104 8 33 83 0  
Fax +49 (0) 2104 833 83 79 99

## Polska

**SNA Europe - Poland Sp. z o. o.**  
ul. Marynarska 15  
02-674 Warszawa  
Tel.: +48 (0) 22 6070510  
Fax: +48 (0) 22 6070521

## Portugal

**SNA Europe [Industries] LDA**  
R. Maria Julia M. Ramos - Junqueira  
4480-254 Vila Do Conde  
Tel. +351 252 650 131  
Fax. +351 252 650 160

## Slovenská republika

**SNA Europe s.r.o.**  
Karadžičova 8/A  
821 08 Bratislava  
Tel: +421 (0)2 5939 6124  
Fax: +421 (0)2 5939 6217

## SRBIJA

**Vermax-alati doo**  
Ul. Drage Spasić 35  
11000 Beograd  
Tel: +381 11 2360 500  
Tel: +381 11 2360 900  
Fax: +381 11 2361 147  
e-mail: office@vermax.rs

## Suomi

**SNA Europe Oy**  
PL 6580  
00002 Helsinki  
Finland  
Tel: +358 207 433 510  
Fax: +358 207 433 525

## Sverige

**SNA Europe Industries AB**  
Box 83  
SE-745 22 Enköping  
Tel: +46 (0) 171-47 82 00  
Fax: +46 (0) 171-47 82 38

## Schweiz / Suisse

**SNA Europe**  
Willettstraße 10  
40822 Mettmann  
Tel: +49 (0) 2104 833 83 0  
Fax: +49 (0) 2104 833 83 7999

## Türkiye

**SNA E Endüstriyel Mam. San. Tic. Ltd. Şti.**  
Girne Mah. Maltepe Küçük San. Sitesi  
F Blok No:19 Maltepe  
Istanbul  
Tel: +90 (0) 216 367 10 21  
Fax: +90 (0) 216 367 11 71

## Украина

**«Бахко Бисов Свенска Акциеболаг»**  
SNA Europe [Ukraine & Moldova]  
Телефон +38 067 441 16 09  
офис 555, улица Армянская, 6А  
Киев, Украина

## United Kingdom

**SNA Europe [UK]**  
Moorhead Way, Bramley,  
Rotherham, South Yorkshire S66 1YY  
Tel: +44 (0) 1709 731731  
Fax: +44 (0) 1709 731741



## Garantía

Para información sobre la garantía visite la página web local [www.bahco.com/es\\_es](http://www.bahco.com/es_es)



Este catálogo comprende nuestra gama actual de productos. De manera regular se realizan cambios tanto en la gama de productos como en el conformado final, formas, diseños y designaciones de los mismos. Estas modificaciones no serán necesariamente notificadas.

Las ilustraciones y croquis han sido reproducidos para ser lo más precisos posibles. Sin embargo, en la elaboración de un catálogo, los mismos pueden diferir respecto a los propios productos y a las especificaciones técnicas.

Las indicaciones de peso deben entenderse como pesos netos aproximados, y sirven principalmente para facilitar el cálculo de los costes de transporte y franqueo.

Este catálogo reemplaza todas las especificaciones y gamas previas.

La propiedad intelectual de este catálogo pertenece a SNA Europe.

Los extractos, reimpresiones o copias de los contenidos solo se pueden realizar con nuestra autorización.

# 2025







M-320-PRI-25



7 314150 564552 >



[www.bahco.com](http://www.bahco.com)

[@bahcoes](https://www.instagram.com/bahcoes)

Este catálogo tarifa es válido únicamente para España